

Conceptual Model Report for the Hill Country Trinity Aquifer Groundwater Availability Model

Prepared by Editors

Nate J. Toll

Ronald T. Green, Ph.D., P.G.

Ronald N. McGinnis

Leanne M. Stepchinski

Rebecca R. Nunu

Gary R. Walter, Ph.D.

From Southwest Research Institute®

Jevon Harding, P.G.

Neil E. Deeds, Ph.D., P.E.

From INTERA Incorporated

Contributors

Mauricio E. Flores, G.I.T.

Kirk D.H. Gulliver

From Southwest Research Institute®

Prepared for:

Texas Water Development Board

P.O. Box 13231, Capitol Station

Austin, Texas 78711-3231

May 31, 2018

Conceptual Model Report for the Hill Country Trinity Aquifer
Groundwater Availability Model

This page is intentionally blank.

Geoscientist and Engineering Seals

This report documents the work of the following Licensed Texas Geoscientists and Engineers:

Dr. Neil Deeds and Jevon Harding conducted the analysis and documentation for work associated with Sections 4.2, 4.5, and 4.6.3 of this project.

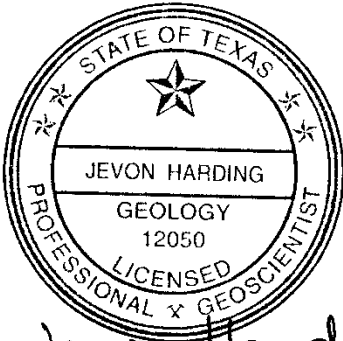

Jevon Harding
5-30-18

Dr. Ronald Green oversaw and conducted analysis and documentation associated with the remaining sections of this project.

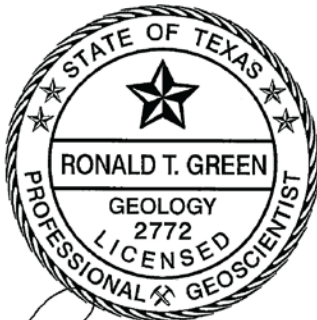

Ronald Green
5/30/2018

Conceptual Model Report for the Hill Country Trinity Aquifer
Groundwater Availability Model

Table of Contents

1.0	Introduction.....	1
2.0	Study Area	3
2.1	Physiography and Climate	14
2.2	Geology.....	29
2.2.1	Geologic Setting.....	29
2.2.2	Surface Geology.....	29
2.2.3	Stratigraphy/Lithology	29
2.2.4	Structural Geology	31
3.0	Previous Investigations	43
4.0	Hydrologic Setting.....	45
4.1	Hydrostratigraphy and Hydrostratigraphic Framework.....	45
4.1.1	Hydrostratigraphic characterization.....	46
4.1.2	Fault Model.....	46
4.1.3	Hydrostratigraphic Framework Model	47
4.1.4	Stratigraphic Framework Model Software.....	48
4.2	Water-level Elevations and Groundwater Flow.....	77
4.2.1	Assigning wells to hydrostratigraphic units.....	77
4.2.2	Data Sources	78
4.2.3	Creation of Water-Level Contours.....	80
4.2.4	Pre-development Water-Level Contours	81
4.2.5	Historical Water-level elevation Contours.....	83
4.2.6	Transient Water-level Data in Individual Wells	86
4.2.7	Transient Water-Level Calibration Targets	88
4.2.8	Cross Formational Flow.....	88
4.3	Recharge	123
4.3.1	Diffuse Recharge	123
4.3.2	Focused Recharge	125
4.4	Rivers, Streams, and Lakes.....	137
4.4.1	Rivers and Streams	137
4.4.2	Lakes and Reservoirs	138
4.5	Hydraulic Properties	155
4.5.1	Data Sources for Transmissivity and Specific Capacity Measurements	155
4.5.2	Literature Sources for Transmissivity and Hydraulic Conductivity Values	157
4.5.3	Analysis of Transmissivity Data.....	158
4.5.4	Calculation of Transmissivity from Specific Capacity.....	159
4.5.5	Spatial Distribution of Transmissivity and Horizontal Hydraulic Conductivity.....	160
4.5.6	Vertical Hydraulic Conductivity.....	162
4.5.7	Storage Properties	163
4.6	Discharge	185
4.6.1	Springs	185
4.6.2	Pumping	186

Conceptual Model Report for the Hill Country Trinity Aquifer
Groundwater Availability Model

4.7	Water Quality	220
4.7.1	General Water Quality	220
4.7.2	Water Quality Trends.....	221
4.7.3	Contribution of Trinity Aquifer to the Edwards (Balcones Fault Zone) Aquifer Based on Water Chemistry	221
5.0	Conceptual Model of Flow in the Aquifer	232
5.1	Overview.....	232
5.2	Discharge	242
5.3	Recharge	249
6.0	References.....	250

Table of Figures

Figure 1.0.1	Major aquifers in Texas	2
Figure 2.0.1	Study boundary and model domain for the updated conceptual framework of the HCT.....	4
Figure 2.0.2	Major roads and urban areas within the study area.....	5
Figure 2.0.3	Regional water planning areas within the study area.....	6
Figure 2.0.4	Groundwater management areas (GMA) within the study area	7
Figure 2.0.5	Groundwater conservation districts (GCDs), underground water conservation districts (UWCDs), and conservation districts (CDs) within the study area	8
Figure 2.0.6	Major streams and rivers within the study area	9
Figure 2.0.7	Major river basins within the study area.....	10
Figure 2.0.8	River authorities within the study area.	11
Figure 2.0.9	Major aquifers within the study area	12
Figure 2.0.10	Minor aquifers within the study area	13
Figure 2.1.1	Physiographic provinces as defined by Wermund (1996)	17
Figure 2.1.2	Level III ecological regions as defined in Griffith and others (2007).	18
Figure 2.1.3	Topographic elevation of the study area.	19
Figure 2.1.4	Climatic classifications as defined by Larkin and Bomar (1983).....	20
Figure 2.1.5	Mean annual average temperature data from 1980-2010 for the study area (PRISM Climate Group, 2016).	21
Figure 2.1.6	Locations of PRISM precipitation stations in the study area.....	22
Figure 2.1.7	Average annual precipitation in the study area from 1980-2015 (PRISM Climate Group, 2016).	23
Figure 2.1.8	Examples of the historical variation in annual precipitation at selected gages from 1920-2010, as available (PRISM Climate Group, 2016).	24

Conceptual Model Report for the Hill Country Trinity Aquifer
Groundwater Availability Model

Figure 2.1.9	The long-term monthly variation in precipitation for the selected gages in Figure 2.1.8 is shown from 1920-2010, as available (PRISM Climate Group, 2016).	25
Figure 2.1.10	Average annual lake evaporation in the study area per quadrangle (map) as well as average monthly lake evaporation from January 1954 through December 2011 for each quadrangle (graphs) (Anaya and Jones, 2009).	26
Figure 2.1.11	Map of the types of vegetation present in the study area (Frye, Brown, and McMahan, 1984).	27
Figure 2.1.12	Map of the types of soil drainage present in the study area (USDA , Natural Resources Conservation Service, 2018).	28
Figure 2.2.1	Stratigraphic and hydrostratigraphic column of the Hill Country. Stratigraphic units are grouped into depositional domains. (Modified from Barker and Ardis, 1996 and Rose, 2016).....	34
Figure 2.2.2	Map showing depositional domains as defined by Barker and Ardis, 1996 and Rose, 2016. Facies markers (Maverick Basin and Devils River Trend) are also shown as well as San Marcos Arch. Figure 2.2.1 references these domains and facies for the stratigraphic nomenclature of the study area.	36
Figure 2.2.3	Updip limits and lateral distribution of Trinity units across study area. Modified from Figure 8 in Barker and Ardis (1996).	37
Figure 2.2.4	Geologic and tectonic synthesis map showing Trinity Group outcrop. Modified from figure 1 in Ferrill and others, 2014, 2017a and b.	38
Figure 2.2.5	Generalized geologic cross-section A-A' modified from Barker and Ardis (1996). Location of section on Figure 2.2.1.....	39
Figure 2.2.6	Generalized geologic cross-section B-B' modified from Barker and Ardis (1996). Location of section on Figure 2.2.1.....	40
Figure 2.2.7	Generalized geologic cross-section C-C' modified from Rose (2016a). Location of section on Figure 2.2.1.	41
Figure 2.2.8	Generalized surface geology within the study area.	42
Figure 4.1.1	Wells used for hydrostratigraphic characterization.	50
Figure 4.1.2	Fault map of faults that were modeled in this study (Hovorka and others, 1998).	51
Figure 4.1.3	Fratesi and others (2015) fault model.	52
Figure 4.1.4	High resolution fault map representing faults from numerous sources (Collins and Hovorka, 1997; Barnes, 1977, 1983; Fisher, 1983; Ferrill and Morris, 2008; Ferrill and others, 2003, 2004, 2005, 2008, 2011; Fratesi and others, 2015).	53
Figure 4.1.5	Flow chart for developing horizon and fault input for implementation into the hydrostratigraphic framework model.....	54
Figure 4.1.6	Flow chart for developing the hydrostratigraphic framework model.	55

Conceptual Model Report for the Hill Country Trinity Aquifer
Groundwater Availability Model

Figure 4.1.7	Flow chart for developing the finalized raster surfaces using ESRI ArcGIS modelbuilder.	56
Figure 4.1.8	The elevation (in feet above mean sea level (MSL)) of the top of the Edwards Group.	57
Figure 4.1.9	Thickness (in feet) of the Edwards Group.	58
Figure 4.1.10	The elevation (in feet above mean sea level (MSL)) of the top of the upper member of the Glen Rose Formation.	59
Figure 4.1.11	Thickness (in feet) of the upper member of the Glen Rose Formation.	60
Figure 4.1.12	The elevation (in feet above mean sea level (MSL)) of the top of the lower member of the Glen Rose Formation.	61
Figure 4.1.13	Thickness (in feet) of the lower member of the Glen Rose Formation.	62
Figure 4.1.14	The elevation (in feet above mean sea level (MSL)) of the top of the Hensell. ..	63
Figure 4.1.15	Thickness (in feet) of the Hensell.	64
Figure 4.1.16	The elevation (in feet above mean sea level (MSL)) of the top of the Cow Creek.	65
Figure 4.1.17	Thickness (in feet) of the Cow Creek.	66
Figure 4.1.18	The elevation (in feet above mean sea level (MSL)) of the top of the Hammett.	67
Figure 4.1.19	Thickness (in feet) of the Hammett.	68
Figure 4.1.20	The elevation (in feet above mean sea level (MSL)) of the top of the Sligo Formation.	69
Figure 4.1.21	Thickness (in feet) of the Sligo Formation.	70
Figure 4.1.22	The elevation (in feet above mean sea level (MSL)) of the top of the Hosston Formation.	71
Figure 4.1.23	Thickness (in feet) of the Hosston Formation.	72
Figure 4.1.24	The elevation (in feet above mean sea level (MSL)) of the top of the Pre-Cretaceous.	73
Figure 4.1.25	E-E' cross-section through the HCT hydrostratigraphic framework model.	74
Figure 4.1.26	F-F' cross-section through the HCT hydrostratigraphic framework model.	75
Figure 4.1.27	G-G' cross-section through the HCT hydrostratigraphic framework model.	76
Figure 4.2.1	Groundwater regions in the current study area.	94
Figure 4.2.2	Spatial distribution of wells with water-level elevation measurements in the Edwards hydrostratigraphic unit.	95
Figure 4.2.3	Spatial distribution of wells with water-level elevation measurements in the Upper Trinity hydrostratigraphic unit.	96

Conceptual Model Report for the Hill Country Trinity Aquifer
Groundwater Availability Model

Figure 4.2.4	Spatial distribution of wells with water-level elevation measurements in the Middle Trinity hydrostratigraphic unit.	97
Figure 4.2.5	Spatial distribution of wells with water-level elevation measurements in the Lower Trinity hydrostratigraphic unit.	98
Figure 4.2.6	Temporal distribution of water-level measurements in the a) Edwards hydrostratigraphic unit and b) Upper Trinity hydrostratigraphic unit.	99
Figure 4.2.7	Temporal distribution of water-level measurements in the a) Middle Trinity hydrostratigraphic unit and b) Lower Trinity hydrostratigraphic unit.	100
Figure 4.2.8	Estimated pre-development water-level elevation contours in feet above mean sea level for the Edwards hydrostratigraphic unit.	101
Figure 4.2.9	Estimated pre-development water-level elevation contours in feet above mean sea level for the Upper Trinity hydrostratigraphic unit.	102
Figure 4.2.10	Estimated pre-development water-level elevation contours in ft above mean sea level for the Middle Trinity hydrostratigraphic unit.	103
Figure 4.2.11	Estimated pre-development water-level elevation contours in feet above mean sea level for the Lower Trinity hydrostratigraphic unit.	104
Figure 4.2.12	Estimated water-level elevation contours in feet above mean sea level in the Edwards hydrostratigraphic unit in 1990.	105
Figure 4.2.13	Estimated water-level elevation contours in feet above mean sea level in the Edwards hydrostratigraphic unit in 2000.	106
Figure 4.2.14	Estimated water-level elevation contours in feet above mean sea level in the Edwards hydrostratigraphic unit in 2010.	107
Figure 4.2.15	Estimated water-level elevation contours in feet above mean sea level in the Upper Trinity hydrostratigraphic unit in 1990.	108
Figure 4.2.16	Estimated water-level elevation contours in feet above mean sea level in the Upper Trinity hydrostratigraphic unit in 2000.	109
Figure 4.2.17	Estimated water-level elevation contours in feet above mean sea level in the Upper Trinity hydrostratigraphic unit in 2010.	110
Figure 4.2.18	Estimated water-level elevation contours in feet above mean sea level in the Middle Trinity hydrostratigraphic unit in 1990.	111
Figure 4.2.19	Estimated water-level elevation contours in feet above mean sea level in the Middle Trinity hydrostratigraphic unit in 2000.	112
Figure 4.2.20	Estimated water-level elevation contours in feet above mean sea level in the Middle Trinity hydrostratigraphic unit in 2010.	113
Figure 4.2.21	Estimated water-level elevation contours in feet above mean sea level in the Lower Trinity hydrostratigraphic unit in 1990.	114
Figure 4.2.22	Estimated water-level elevation contours in feet above mean sea level in the Lower Trinity hydrostratigraphic unit in 2000.	115

Conceptual Model Report for the Hill Country Trinity Aquifer
Groundwater Availability Model

Figure 4.2.23	Estimated water-level elevation contours in feet above mean sea level in the Lower Trinity hydrostratigraphic unit in 2010	116
Figure 4.2.24	Select hydrographs for the Edwards hydrostratigraphic unit in the Edwards-Trinity (Plateau) region.....	117
Figure 4.2.25	Select hydrographs for the Upper Trinity hydrostratigraphic unit.....	118
Figure 4.2.26	Select hydrographs for the Middle Trinity hydrostratigraphic unit in the west and west-central portions of the study area.....	119
Figure 4.2.27	Select hydrographs for the Middle Trinity hydrostratigraphic unit in the east and east-central portions of the study area.....	120
Figure 4.2.28	Select hydrographs for the Lower Trinity hydrostratigraphic unit in the study area.....	121
Figure 4.2.29	Comparison of water-level elevations between different hydrostratigraphic units.....	122
Figure 4.3.1	Map showing the location of the evaporation quadrangles and PRISM precipitation raster pixels used to calculate diffuse recharge within the conceptual model study area.....	127
Figure 4.3.2	Map showing the locations of PRISM raster pixels and the HUC-6 basins they fall within.....	128
Figure 4.3.3	Average annual lake evaporation for each quadrangle in the study area. Average annual lake evaporation for each month in each quadrangle is shown in the respective graph.....	129
Figure 4.3.4	Distribution of diffuse recharge in November 2004 calculated using the Excel Analytical Model populated with default values.....	130
Figure 4.3.5	Distribution of diffuse recharge in February 2009 calculated using the Excel Analytical Model populated with default values.....	131
Figure 4.3.6	PRISM pixel cells used to calculate focused recharge in outcrop area of HCT study area.....	132
Figure 4.3.7	Calculated Focused recharge using 2% of precipitation at every PRISM cell directed to the nearest major stream or river and scaled according to its distance from the stream.....	133
Figure 4.3.8	Calculated Focused recharge using 2% of precipitation at every PRISM cell directed to the nearest major stream or river and scaled according to its distance from the stream.....	134
Figure 4.3.9	Combined focused and diffuse recharge for November 2004 (inches/month)....	135
Figure 4.3.10	Combined focused and diffuse recharge for November 2009 (inches/month)....	136
Figure 4.4.1	Locations of USGS Stream Gages in the study area. Gage locations with Hydrographs appearing in this report are indicated in red.....	141
Figure 4.4.2	Stream Discharge hydrographs for selected gauging sites in the HCT study area.....	142

Conceptual Model Report for the Hill Country Trinity Aquifer
Groundwater Availability Model

Figure 4.4.3	Gain/loss measurements in the study area (Slade and others, 2002 and Gary, 2018).	147
Figure 4.4.4	Synoptic gain/loss measurements of the Nueces River (Gary, 2018).....	148
Figure 4.4.5	Synoptic gain/loss measurements of the Blanco River (Gary, 2018).	149
Figure 4.4.6	Major lakes and reservoirs in the study area.....	150
Figure 4.4.7	Hydrographs of major lakes in the study area 1940-2018.	151
Figure 4.5.1	Distribution of horizontal hydraulic conductivity calculated from Texas Commission on Environmental Quality well records, based on the Edwards-Trinity (Plateau) Aquifer GAM database (Anaya and Jones, 2009).....	169
Figure 4.5.2	Location of available transmissivity data by hydrostratigraphic unit in the study area.	170
Figure 4.5.3	Location of available specific capacity data by hydrostratigraphic unit in the study area.	171
Figure 4.5.4	Upper Trinity transmissivity – specific capacity measurement pairs compared to transmissivity values calculated by Mace (2001) methods (empirical relationship and Theis method).....	172
Figure 4.5.5	Middle Trinity transmissivity – specific capacity measurement pairs compared to transmissivity values calculated by Mace (2001) methods (empirical relationship and Theis method).....	173
Figure 4.5.6	Lower Trinity transmissivity – specific capacity measurement pairs compared to transmissivity values calculated by Mace (2001) methods (empirical relationship and Theis method).....	174
Figure 4.5.7	Spatial distribution of transmissivity values for the upper Trinity hydrostratigraphic unit.	175
Figure 4.5.8	Spatial distribution of transmissivity values for the Middle Trinity hydrostratigraphic unit.	176
Figure 4.5.9	Spatial distribution of transmissivity values for the Lower Trinity hydrostratigraphic unit.	177
Figure 4.5.10	Spatial distribution of horizontal hydraulic conductivity values for the Upper Trinity hydrostratigraphic unit.....	178
Figure 4.5.11	Spatial distribution of horizontal hydraulic conductivity values for the Middle Trinity hydrostratigraphic unit.....	179
Figure 4.5.12	Spatial distribution of horizontal hydraulic conductivity values for the Lower Trinity hydrostratigraphic unit.....	180
Figure 4.5.13	Comparison of calculated values and selected literature values for transmissivity by hydrostratigraphic unit.....	181
Figure 4.5.14	Histogram of horizontal hydraulic conductivity in feet per day for (a) Upper Trinity hydrostratigraphic unit, (b) Middle Trinity hydrostratigraphic unit, and (c) Lower Trinity hydrostratigraphic unit.	182

Conceptual Model Report for the Hill Country Trinity Aquifer
Groundwater Availability Model

Figure 4.5.15	Comparison of calculated values and selected literature values for hydraulic conductivity by hydrostratigraphic unit	183
Figure 4.5.16	Location of available storativity data by hydrostratigraphic unit in the study area	184
Figure 4.6.1	Selected named springs in the study area.	206
Figure 4.6.2	Springs located in study area. Circle symbology indicates the geological group from which the spring discharges water as specified in the TWDB GWDB.....	207
Figure 4.6.3	Estimated rural domestic pumping by hydrostratigraphic unit outcrop in the study area, based on 1990 census block rural population data (Manson and others, 2017)	208
Figure 4.6.4	Estimated rural domestic pumping by hydrostratigraphic unit outcrop in the study area, based on 2000 census block rural population data (Manson and others, 2017)	209
Figure 4.6.5	Estimated rural domestic pumping by hydrostratigraphic unit outcrop in the study area, based on 2010 census block rural population data (Manson and others, 2017)	210
Figure 4.6.6	Estimated total pumping by hydrostratigraphic unit in the western/west-central counties of the study area.....	211
Figure 4.6.7	Estimated total pumping by hydrostratigraphic unit in the eastern/east-central counties of the study area.....	212
Figure 4.6.8	Estimated total pumping by water-use category in the western/west-central counties of the study area.....	213
Figure 4.6.9	Estimated total pumping by water-use category in the eastern/east-central counties of the study area.....	214
Figure 4.6.10	Locations of municipal and industrial wells in the study area by hydrostratigraphic unit	215
Figure 4.6.11	Estimated distribution of irrigated land and rangeland based on Vogelmann and others (2001)	216
Figure 4.6.12	Estimated distribution of irrigated land and rangeland based on Homer and others (2007)	217
Figure 4.6.13	Estimated distribution of irrigated land and rangeland based on Homer and others (2015)	218
Figure 4.7.1	Total Dissolved Solids (TDS) in the Trinity Aquifer and Edwards-Trinity Aquifer within the revised Hill Country GAM study area	222
Figure 4.7.2	Total Dissolved Solids (TDS) in the Upper Trinity within the revised Hill Country GAM study area.....	223
Figure 4.7.3	Total Dissolved Solids (TDS) in the Middle Trinity within the revised Hill Country GAM study area.....	224

Conceptual Model Report for the Hill Country Trinity Aquifer
Groundwater Availability Model

Figure 4.7.4	Total Dissolved Solids (TDS) in the Lower Trinity within the revised Hill Country GAM study area.....	225
Figure 4.7.5	Cumulative Distribution of Total Dissolved Solids (TDS in the Upper, Middle, and Lower Trinity Aquifer, Edwards-Trinity (Plateau) Region, and Edwards and Trinity aquifers in the Balcones Fault Zone.....	226
Figure 4.7.6	Piper diagram showcasing the major ion composition of groundwater in the Trinity Aquifer and Edwards-Trinity (Plateau) area.....	227
Figure 4.7.7	Sulfate and chloride concentrations versus Total Dissolved Solids (TDS in the Trinity Aquifer.	228
Figure 4.7.8	Sulfate and chloride concentrations versus depth in the Edwards-Trinity (Plateau) area.	229
Figure 4.7.9	Time histories of Total Dissolved Solids (TDS in selected wells within the revised Hill Country Model domain completed in the Trinity Aquifer, Edwards-Trinity (Plateau) Region, and Edwards and Trinity aquifers in the Balcones Fault Zone.	230
Figure 4.7.10	Mixing between the Trinity Aquifer and Edwards (Balcones Fault Zone) Aquifer interpreted based on major ion ratios (taken from Musgrove and others, 2010).	231
Figure 5.1.1	Map of the study area with major river watersheds. Location of three cross-sections present in Figure 5.1.3, 5.1.5, and 5.1.7 are illustrated.....	234
Figure 5.1.2	Hydrostratigraphic vertical cross section A-A' with flow between layers.	235
Figure 5.1.3	Block diagram of A-A' transect illustrating how the conceptual model translates to the numerical model.	236
Figure 5.1.4	Hydrostratigraphic vertical cross section B-B' with flow between layers.	237
Figure 5.1.5	Block diagram of B-B' transect illustrating how the conceptual model translates to the numerical model.	238
Figure 5.1.6	Hydrostratigraphic vertical cross section C-C' with flow between layers.	239
Figure 5.1.7	Block diagram of C-C' transect illustrating how the conceptual model translates to the numerical model.	240
Figure 5.1.8	Map with study and model boundaries delineated.....	241
Figure 5.2.1	Direction of groundwater flow in the Edwards (Balcones Fault Zone) Aquifer (from Fratesi and others, 2015).....	243
Figure 5.2.2	Water well locations designated by well formation from the TWDB groundwater database.....	244
Figure 5.2.3	Water well locations designated by well formation from the Texas Brackish Resources Aquifer Characterization System (BRACS) Database.	245
Figure 5.2.4	Water well locations designated by well formation from the Public Water Supply (PWS) database administered by the Texas Commission on Environmental Quality.....	246

Conceptual Model Report for the Hill Country Trinity Aquifer
Groundwater Availability Model

Figure 5.2.5 Water well locations designated by well formation from the Submitted Driller Reports (SDR).....247

Figure 5.2.6 Water well locations designated by well formation from the U.S. Geological Survey.248

Conceptual Model Report for the Hill Country Trinity Aquifer
Groundwater Availability Model

Table of Tables

Table 2.2.1	Literature used for geologic and hydrogeologic context.	33
Table 4.2.1	Number of wells with water-level data and number of water-level measurements by hydrostratigraphic unit by groundwater region (as defined in Figure 4.2.1).....	92
Table 4.2.2	Number of wells with water-elevation measurements in each hydrostratigraphic unit by decade.	93
Table 4.2.3	Number of water-level measurements in each hydrostratigraphic unit by decade.	93
Table 4.2.4	Number of water-level targets for the transient model in each hydrostratigraphic unit by groundwater region (as defined in Figure 4.2.1) and by decade.	93
Table 4.3.1	Default Weighting factors, Φ_i , Max P, and a to account for antecedent moisture and evaporation.....	126
Table 4.4.1	Summary statistics for automated baseflow separation filter.	139
Table 4.5.1	Hydraulic property data available for each hydrostratigraphic unit .	166
Table 4.5.2	Transmissivity values from compiled pump tests and calculated from specific capacity data.....	166
Table 4.5.3	Comparison of transmissivity values calculated in the current study and compiled from literature.....	167
Table 4.5.4	Hydraulic conductivity values from compiled pump tests and calculated from specific capacity data.....	167
Table 2.1.5	Comparison of hydraulic conductivity values calculated in the current study and compiled from literature.....	168
Table 2.1.6	Storativity values available from compiled aquifer pump tests and compiled from literature.....	168
Table 4.6.1	Initial reference elevation, calibrated elevation and calibrated conductivity of springs and points of discharge. Locations and elevations taken from TWDB GWDB for all springs.....	196
Table 4.6.2	Summary of early recorded groundwater use from the Trinity hydrostratigraphic units in the study area.	197
Table 4.6.3	Percentage of county-wide Trinity Aquifer and Edwards-Trinity (Plateau) Aquifer pumping sourced from each Trinity hydrostratigraphic unit by decade.	198
Table 4.6.4	Summary of pumping in acre-feet from Trinity hydrostratigraphic units by county for the years 1980, 1990, 2000, and 2010.	202
Table 4.6.5	Pumping in acre-feet from Trinity hydrostratigraphic units by county compared to 2008 pumping estimates in Groundwater Management Area 9.....	205

Conceptual Model Report for the Hill Country Trinity Aquifer
Groundwater Availability Model

This page is intentionally blank.

1.0 Introduction

The Texas Water Development Board (TWDB) completed the Hill Country Trinity (HCT) Aquifer Groundwater Availability Model (GAM) in 2000 in cooperation with the Trinity Aquifer Advisory Committee which included members of local groundwater districts, river authorities, county governments, regional water planning groups, and concerned citizens. In 2009, the TWDB completed an update to include the lower Trinity as a fourth model layer.

In 2017, the TWDB contracted Southwest Research Institute[®] (SwRI) to update the conceptual model of the HCT Aquifer with three objectives: (1) expand the model region to include the downdip portion of the Trinity Aquifer and all of Groundwater Management Area (GMA) 9; (2) develop an understanding of inter-formational flow between the Edwards (Balcones Fault Zone) Aquifer and HCT; and (3) extend the datasets for water elevations, water chemistry, recharge, discharge, and hydraulic parameters, both spatially and temporally. This report will assist in responding to the need for improved conceptual and numerical models, and water availability issues of the HCT in support of its designation as a Priority Groundwater Management Area (PGMA).

The Trinity Aquifer is classified as one of nine major aquifers in Texas (Figure 1.0.1). It extends from the Texas-Oklahoma border to south-central Texas and provides water to large areas throughout the 52 counties it underlies. The Trinity Aquifer is subdivided into Hill Country and northern portions. This report focuses solely on the Hill Country portion of the Trinity Aquifer and will hereby be referenced as the HCT Aquifer. Historically, the HCT Aquifer has not been a prolific source of water in comparison to other aquifers in the region, such as the Edwards (Balcones Fault) Aquifer. However, renewed interest has been placed on the HCT Aquifer as a water resource in south-central Texas, especially in and around Austin and San Antonio, as demands continue to increase due to development and population growth. Numerous studies have explored the aquifer system, as in-depth and continuing investigations focus on refining previous GAMs (Mace and others, 2000; Jones and others, 2011), interactions with the Edwards (Balcones Fault Zone) Aquifer (Small, 1986; Ridgeway and Petrini, 1999; LBG-Guyton Associates and NRS Consulting Engineers, 1995; Smith and Hunt, 2009; Fratesi and others, 2015), and potential brackish water production (LBG-Guyton Associates and NRS Consulting Engineers, 2003). In addition, the TWDB periodically solicits feedback on the Groundwater Availability Modeling projects from the public.

This report includes descriptions of the following components to satisfy these objectives: (1) physiography and climate, (2) geology, (3) hydrostratigraphy, (4) hydrostratigraphic framework, (5) water elevations and regional groundwater flow, (6) recharge, (7) rivers, streams, reservoirs, springs, and other surface water features, (8) hydraulic properties, (9) subsidence, (10) discharge, and (11) water quality. The refinement of the conceptual model for the HCT Aquifer will ultimately facilitate TWDB to develop a new GAM to assess future groundwater conditions of the aquifer.

Conceptual Model Report for the Hill Country Trinity Aquifer
Groundwater Availability Model

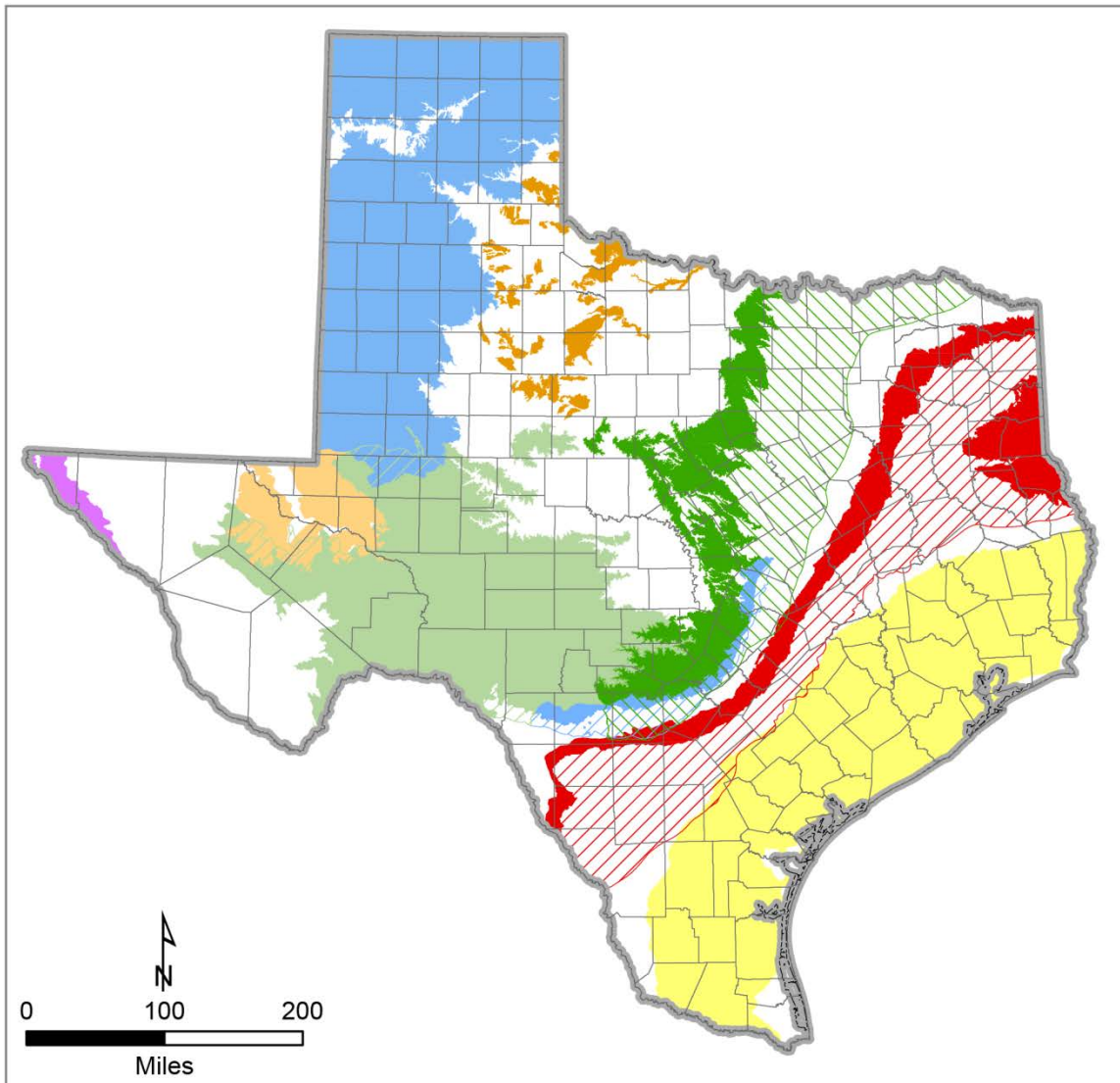

Major aquifers in Texas



Figure 1.0.1 Major aquifers in Texas.

2.0 Study Area

The outcrop and subcrop regions of the HCT Aquifer cover 14 counties in Texas. To meet the objectives for updating the conceptual framework of the aquifer, the study area and model boundary are extended to encompass 28 counties total, from Val Verde and Edwards counties in the west to Travis, Williamson, and Bastrop counties in the east (Figure 2.0.1). Moreover, the new study area includes the entirety of GMA 9 and the downdip boundary of the HCT Aquifer. It is important to note that while this study boundary is intended to facilitate the improvement of a future GAM, it is not necessarily the domain for that numerical model.

Figure 2.0.2 shows major urban areas and roadways within the study region. Major cities, particularly Austin and San Antonio, as well as major roadways, are most dense along the southeastern edge of the study area, which is coincident with the I-35 corridor.

The HCT Aquifer study area encompasses numerous political and administrative boundaries tasked with protecting both surface water and groundwater resources within the region. Five regional water planning areas (RWPAs) are within the study area: Brazos G, Region F, Lower Colorado, (Plateau), and South Central Texas (Figure 2.0.3). Figure 2.0.4 illustrates that GMAs 7, 8, 9, 10, 12, and 13 also lie within the study area. The study area encompasses 23 Groundwater Conservation Districts (GCDs), as labeled and shown in Figure 2.0.5. Major rivers and streams within these basins are depicted in Figure 2.0.6. Examples include the Nueces River, Medina River, Guadalupe River, and Colorado River, which occur within their respectively named river basins (Figure 2.0.7). These surface-water features are protected by eight different river authorities (Figure 2.0.8).

In addition to the HCT Aquifer, the Edwards-Trinity (Plateau) Aquifer, Edwards (Balcones Fault Zone) Aquifer, and the uppermost extent of the Carrizo-Wilcox Aquifer fall within the study area (Figure 2.0.9). Minor aquifers, specifically a significant portion of the Hickory, Marble Falls, and Ellenburger-San Saba aquifers, as well as a sliver of the Queen City Aquifer, are encompassed by the study domain boundary (Figure 2.0.10).

Conceptual Model Report for the Hill Country Trinity Aquifer
Groundwater Availability Model

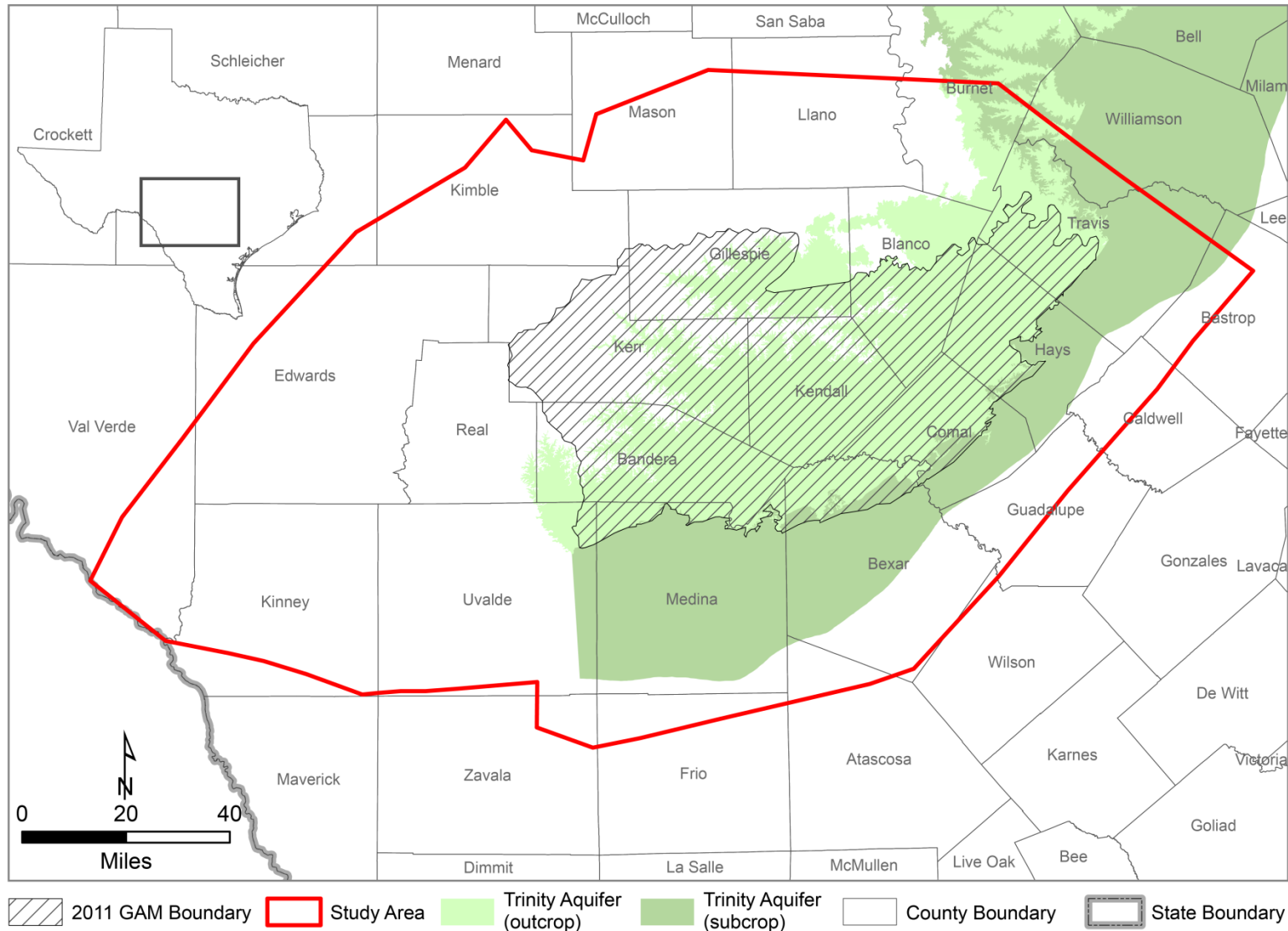

Figure 2.0.1 Study boundary and model domain for the updated conceptual framework of the HCT.

Conceptual Model Report for the Hill Country Trinity Aquifer
Groundwater Availability Model

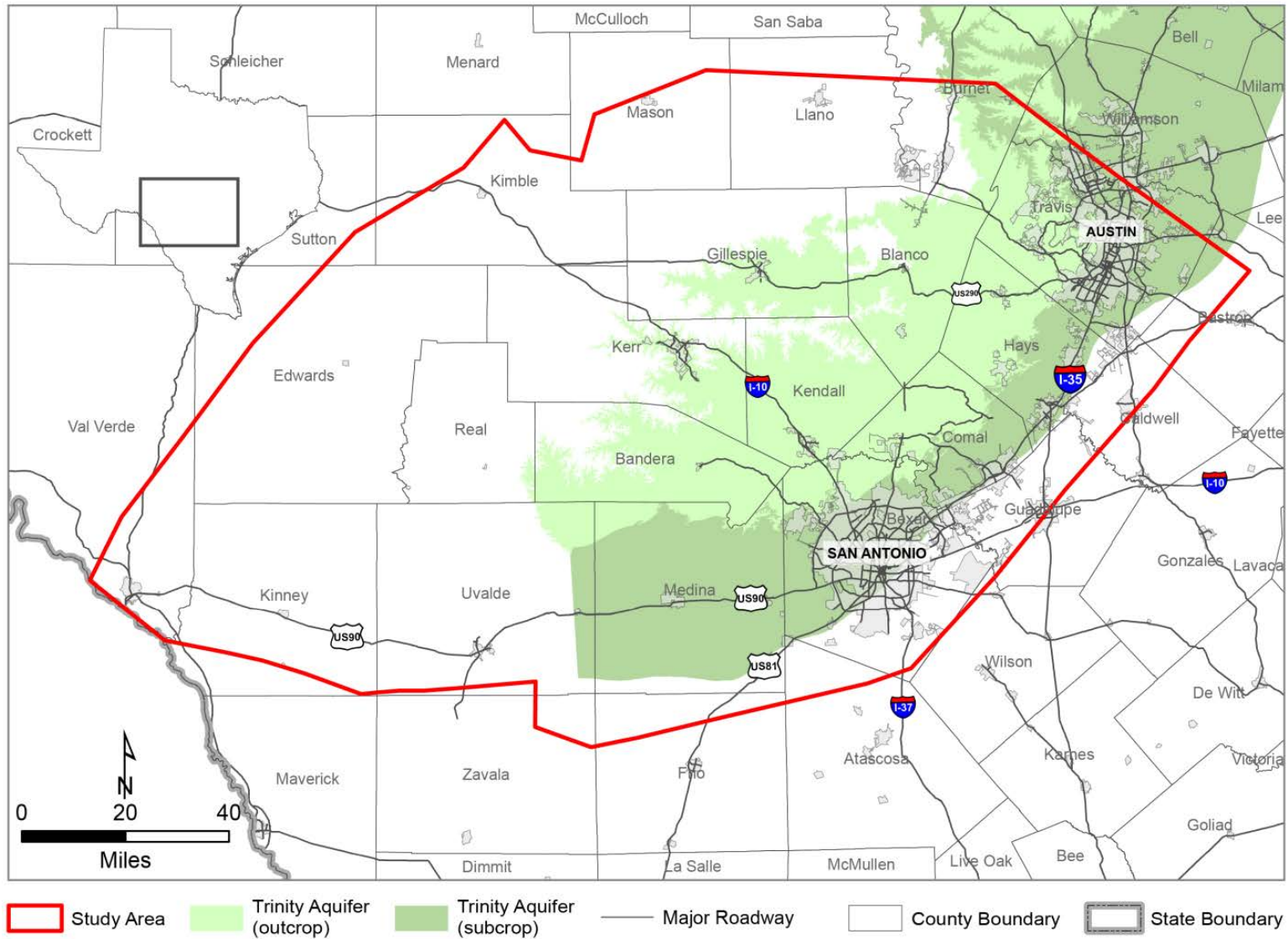

Figure 2.0.2 Major roads and urban areas within the study area.

Conceptual Model Report for the Hill Country Trinity Aquifer
Groundwater Availability Model

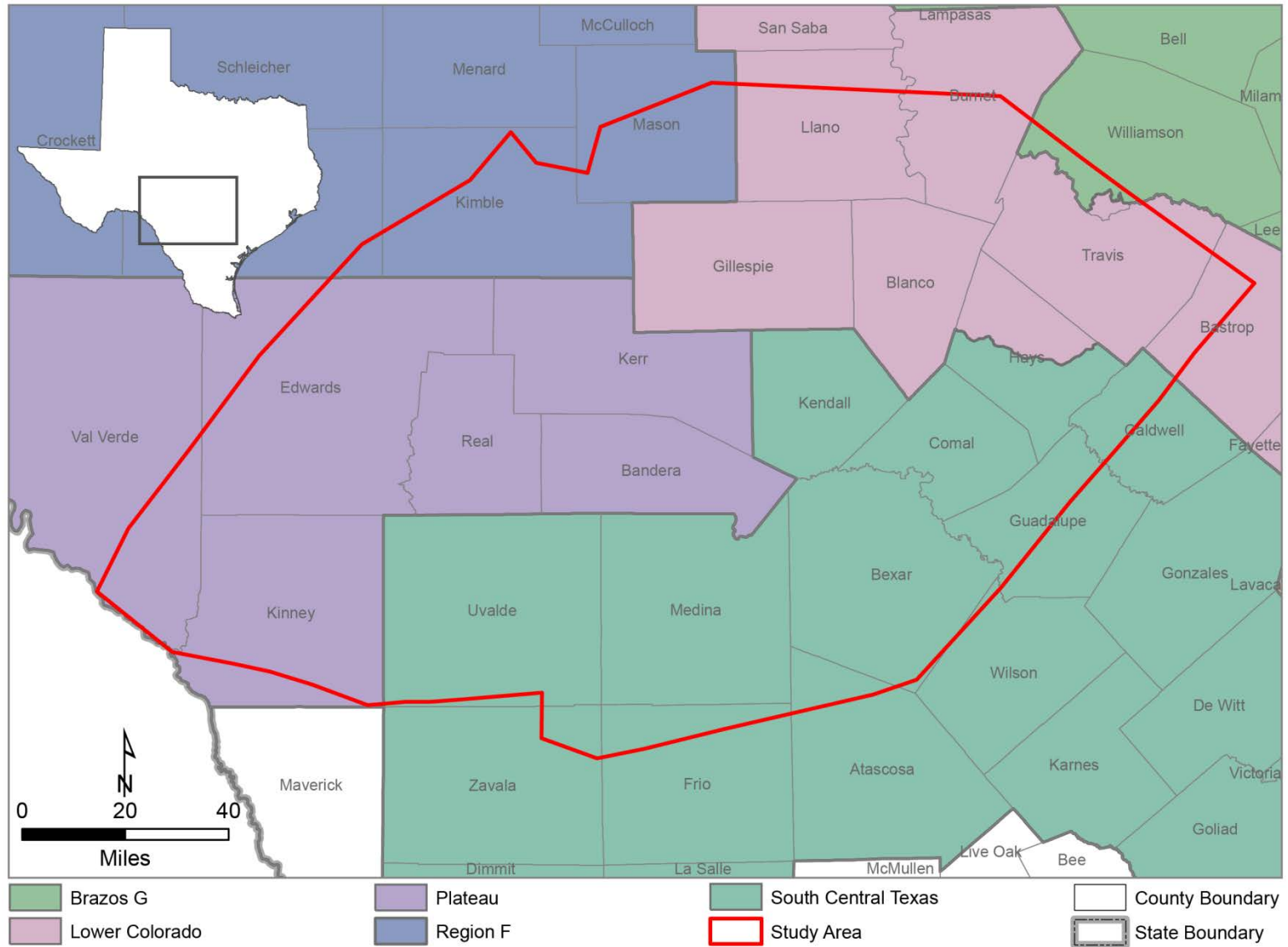

Figure 2.0.3 Regional water planning areas within the study area.

Conceptual Model Report for the Hill Country Trinity Aquifer
Groundwater Availability Model

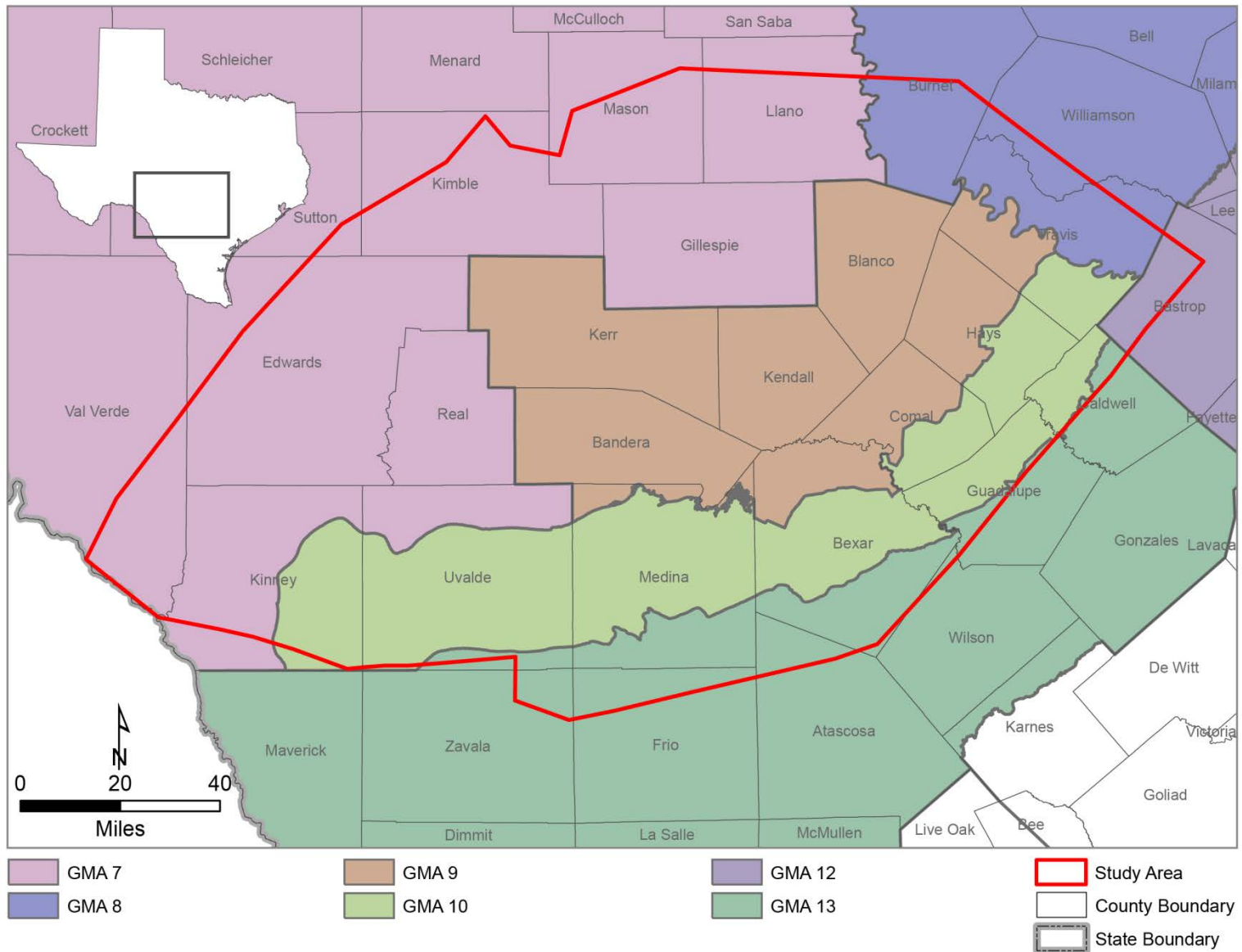

Figure 2.0.4 Groundwater management areas (GMA) within the study area.

Conceptual Model Report for the Hill Country Trinity Aquifer
Groundwater Availability Model

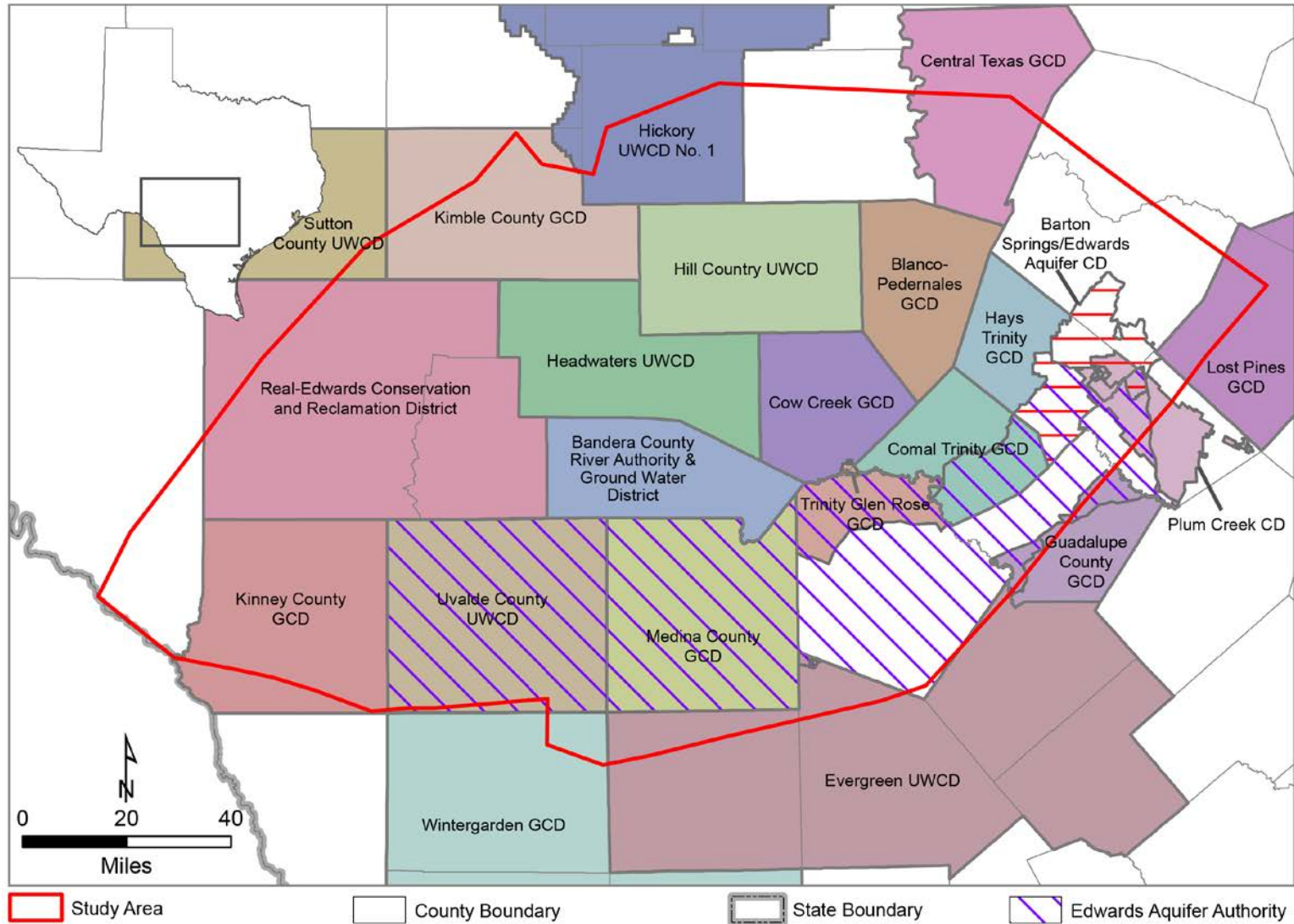

Figure 2.0.5 Groundwater conservation districts (GCDs), underground water conservation districts (UWCDs), and conservation districts (CDs) within the study area.

Conceptual Model Report for the Hill Country Trinity Aquifer
Groundwater Availability Model

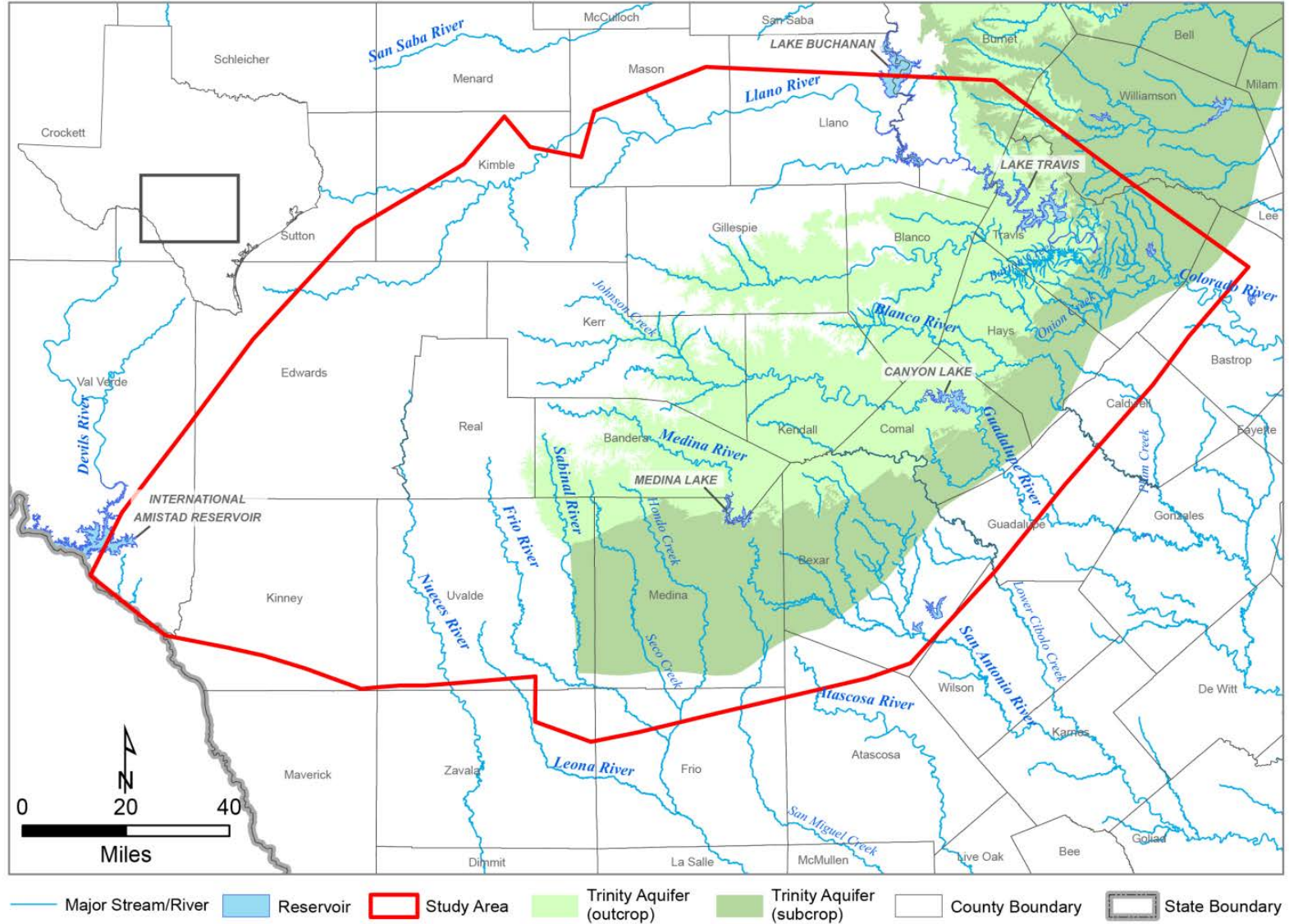

Figure 2.0.6 Major streams and rivers within the study area.

Conceptual Model Report for the Hill Country Trinity Aquifer
Groundwater Availability Model

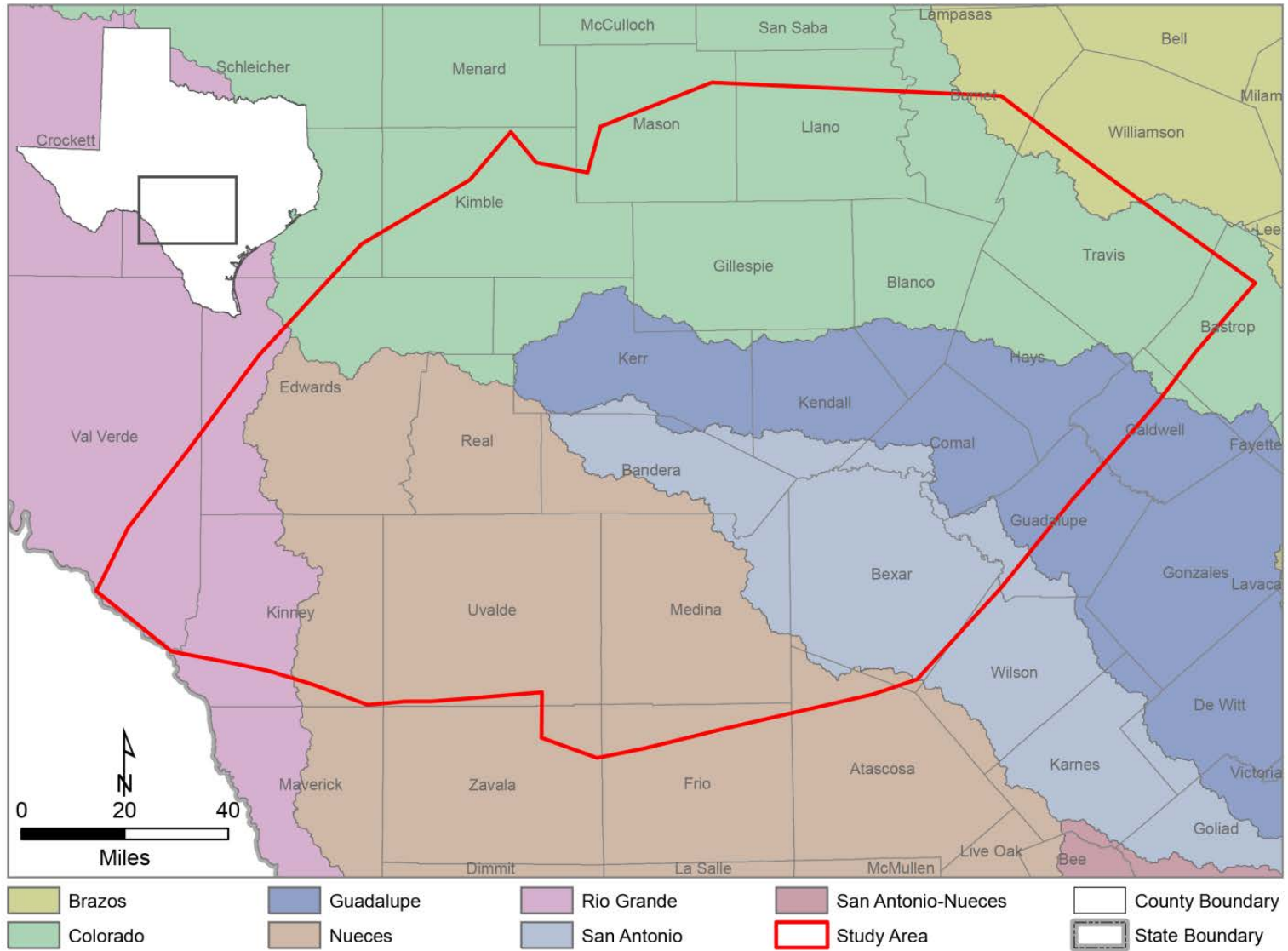

Figure 2.0.7 Major river basins within the study area.

Conceptual Model Report for the Hill Country Trinity Aquifer
Groundwater Availability Model

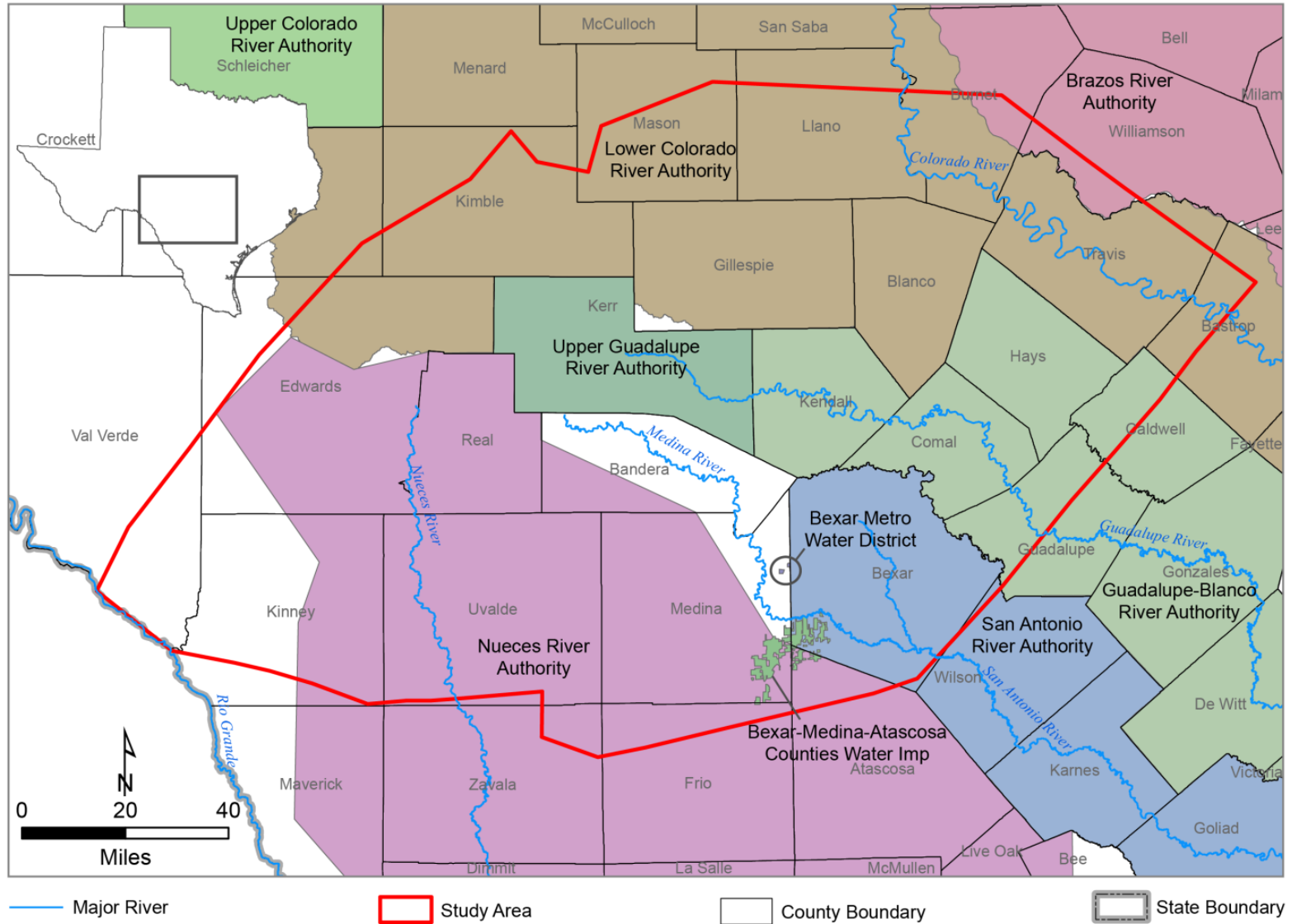

Figure 2.0.8 River authorities within the study area.

Conceptual Model Report for the Hill Country Trinity Aquifer
Groundwater Availability Model

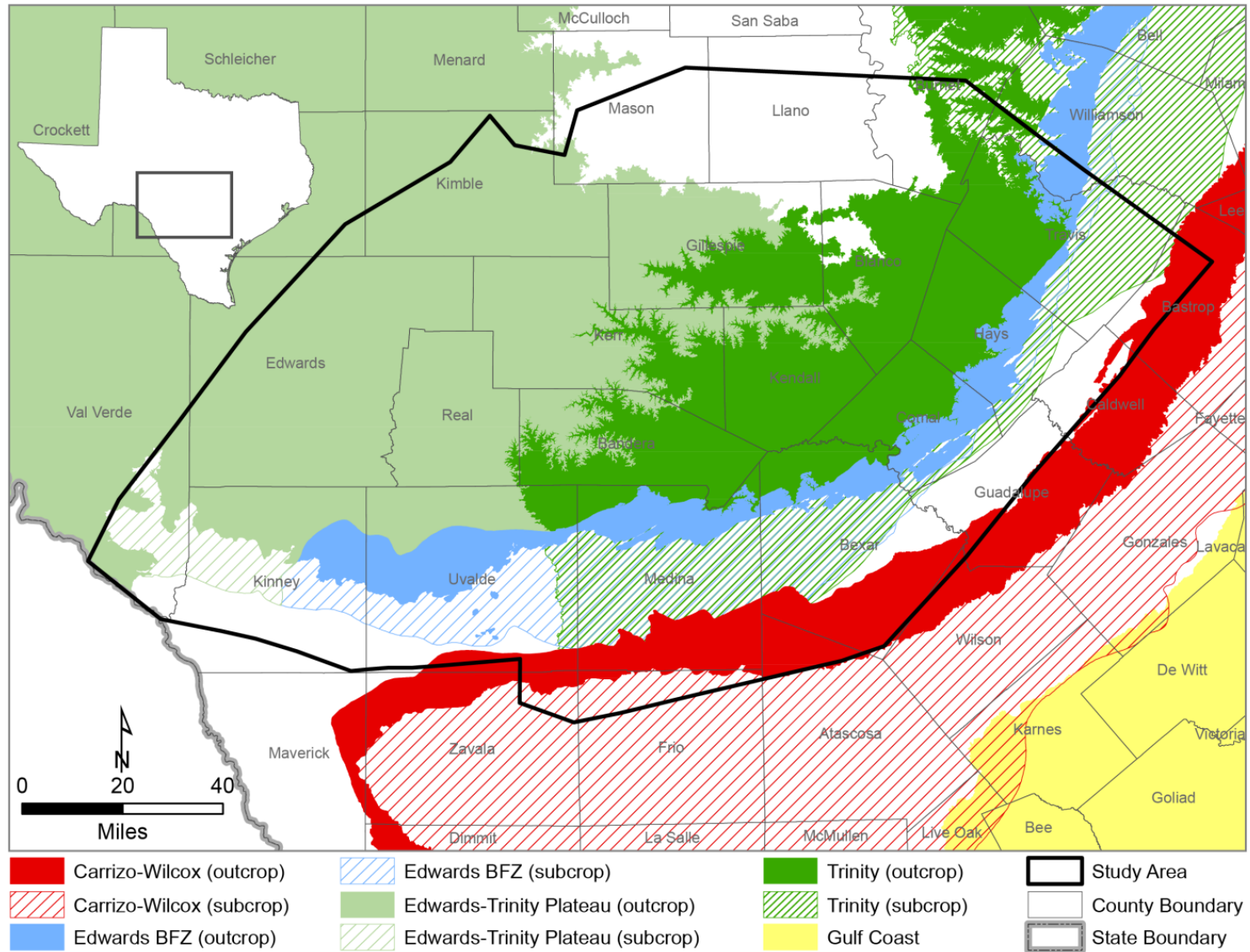

Figure 2.0.9 Major aquifers within the study area.

Conceptual Model Report for the Hill Country Trinity Aquifer
Groundwater Availability Model

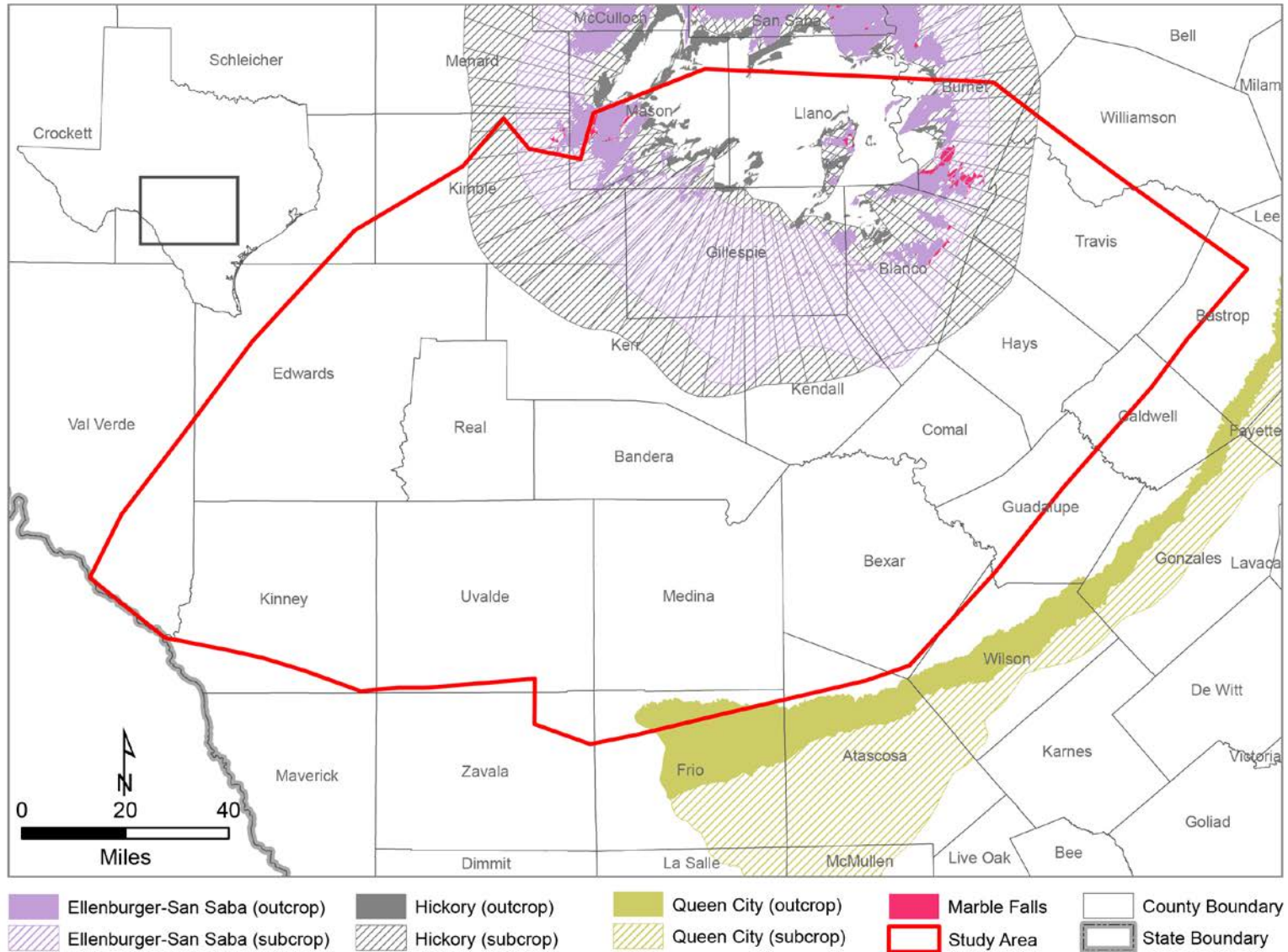

Figure 2.0.10 Minor aquifers within the study area.

2.1 Physiography and Climate

The study area is located in the Coastal Plain and the Great Plains national physiographic provinces as defined by the U.S. Geological Survey (USGS, 2002). Additionally, the study area encompasses portions of the Edwards (Plateau), Central Texas Uplift, Blackland Prairies, and Interior Coastal Plains Texas Physiographic Provinces (Figure 2.1.1) as defined by Wermund (1996). Wermund (1996) describes the Edwards (Plateau) and Balcones Escarpment as a plateau including the Hill Country, capped with limestone and entrenched by streams. The Central Texas Uplift is described as a central, granite hill-studded basin, Balcones Escarpment. The Gulf Coastal Plains (including the Blackland Prairies and the Interior Coastal Plains regions) is described as the product of deltaic sediment deposits which erodes to the southeast.

The study area contains five Level III ecological regions as designated by a 2007 Texas Commission on Environmental Quality (TCEQ) study (Figure 2.1.2) (Griffith and others, 2007). These include the Edwards (Plateau), the Southern Texas Plains, the Texas Blackland Prairies, the East Central Texas Plains, and the Chihuahuan Deserts. Ecological regions, or ecoregions, are areas containing generally similar ecosystems and types, quantities, and qualities of environmental resources. Ecological frameworks are valuable tools for environmental research, as well as the assessment, management, and monitoring of ecosystems and ecosystem components.

The majority of the study area lies in the Edwards (Plateau) ecological region. This region is characterized by elevated plateaus, rolling hills, and broad valleys and plains. Vegetation includes mostly woodlands, shrublands, and grasslands. The Llano Uplift and the Balcones Fault Zone are major geologic features of the area. Much of this region is underlain by limestone, with karst topography. A majority of the soils are Mollisols and are shallow to moderately deep on plateaus and hills, transitioning to deeper soils on valley floors and plains. Juniper oak and mesquite oak savannah with some Ashe juniper woodland covers most of the Edwards (Plateau), and the land in this region is presently utilized for livestock grazing and wildlife hunting.

The Texas Blackland Prairies, present along most of the eastern border of the study area, contain fine-textured, clayey soils. This region contains a higher percentage of cropland than surrounding regions, which is increasingly under conversion to urban, suburban, and industrial use. The Southern Texas Plains present in the southernmost portion of the study area are cut by streams and arroyos and have low-growing, thorny-brush vegetation. While previously covered by grassland and savannah vegetation, these areas are presently dominated by mesquite vegetation. The East Central Texas Plains ecological region, also known as the Post Oak Savannah due to its original land cover of post oak savannah type vegetation, is currently utilized as pasture land. The soils in this region are dominantly acidic sandy loam along ridges and clay loams in the lowlands. A small area of Chihuahuan Basins and Playas, sub-ecoregions of the Chihuahuan Deserts, is present in the southwestern corner of the study area. This ecoregion experiences some of the lowest rainfall in the state and is characterized by alkaline and gypsiferous soils with desert shrub vegetation.

Conceptual Model Report for the Hill Country Trinity Aquifer
Groundwater Availability Model

Figure 2.1.3 illustrates the topography in the study area. The ground-surface elevation generally decreases with dip from northwest to southeast. The maximum elevations of about 2,421 feet in the northwest and the lowest elevations of about 338 feet are southeast of the Balcones Fault Zone. Faulting in this area resulted in steep drop-offs in elevation, particularly in Bexar and Medina counties. The drainage features of the major rivers are reflected in the topographic gradients over much of the study area.

Figure 2.1.4 shows the climatic classifications as defined by Larkin and Bomar (1983). Subtropical classification is subdivided based on moisture content as follows. The westernmost portion of the study area is classified as Subtropical Steppe, with semi-arid to arid climatic conditions. The central portion is classified as Subtropical Subhumid, with hot summers and dry winters. The eastern portion is classified as Subtropical Humid, characterized by warm summers. The Subtropical climate is caused by flow of air from the Gulf of Mexico onshore. This inflowing maritime air decreases in moisture content heading westward away from the coast. Seasonal intrusions of continental air also cause a decrease in air moisture content in the area.

Parameter-elevation Regressions on Independent Slopes Model (PRISM) datasets developed and presented online by Oregon State University provide distributions of average annual temperature and precipitation across the 48 conterminous United States for the 30-year period 1981 to 2010 (PRISM Climate Group, 2016). These data indicate that the average annual temperature in the study area ranges from a low of 63° F in the northern central portion of the study area to a high of 70° F in the southern and southwestern portions of the study area (Figure 2.1.5).

PRISM precipitation data are available at over 131 precipitation stations within the study area (Figure 2.1.6) from as early as 1931 through the present. Measurement of precipitation at most gages began in the 1940s or 1950s. Measurement by NEXRAD radar in the study area generally began in 2001. Average annual precipitation in the study area from 1980-2015 are plotted in Figure 2.1.7 (PRISM Climate Group, 2016). In general, measurements are not continuous on a month-by-month or year-by-year basis at the gages. Examples of the historical variation in annual precipitation at a few selected gages are shown in Figure 2.1.8. The long-term monthly variation in precipitation for these same selected gages is shown in Figure 2.1.9. For each selected gage, the time period for the monthly average precipitations shown in Figure 2.1.9 is the same as the time period for the annual precipitation shown in Figure 2.1.8. The monthly average data indicate that precipitation peaks in late spring to early summer, and again in early fall at a majority of the selected sites.

Average annual lake evaporation in the study area ranges from a high of 66 inches per year in the west to a low of 52 inches per year in the east (Anaya and Jones, 2009), as shown in Figure 2.1.10. The evaporation rates in the study area significantly exceed the average annual rainfall, resulting in precipitation deficits (evaporation exceeding precipitation). The study area has a precipitation deficit of 30 inches per year in the east to almost 50 inches per year in the west. Monthly variations in lake surface evaporation are shown in Figure 2.1.10 for each quadrangle in the study area. These values represent the average of the monthly lake surface evaporation data from January 1980 through December 2016. Figure 2.1.10 shows that average lake evaporation peaks in July.

Conceptual Model Report for the Hill Country Trinity Aquifer
Groundwater Availability Model

Figure 2.1.11 illustrates the types of vegetation present in the study area as defined by the Texas Parks and Wildlife Department (Frye, Brown, and McMahan, 1984). The predominant types of vegetation include Live Oak-Mesquite Parks in the north, Mesquite-Blackland Brush to the southwest, converted Cropland in the southwest, and Live Oak-Mesquite-Ashe Juniper Parks, Live Oak-Ashe Juniper Parks, and Live Oak-Ashe Juniper Woods to the northwest and throughout the central regions of the study area.

Soil properties may have a significant impact on the amount of precipitation that infiltrates to groundwater and the amount of moisture that is lost to evapotranspiration. Figure 2.1.12 illustrates the drainage values of the various soils across the region as defined by the USDA (USDA, Natural Resources Conservation Service, 2018). The study area is dominated by well drained soils, transitioning into a mix of well-drained and moderately well-drained soils to the southern and southeastern borders. There are isolated areas of excessively drained, somewhat excessively drained, and somewhat poorly drained soils. All Soil Survey Geographic Database (SSUGRO) Soil properties are included in the GAM geodatabase for the entire study area.

Conceptual Model Report for the Hill Country Trinity Aquifer
Groundwater Availability Model

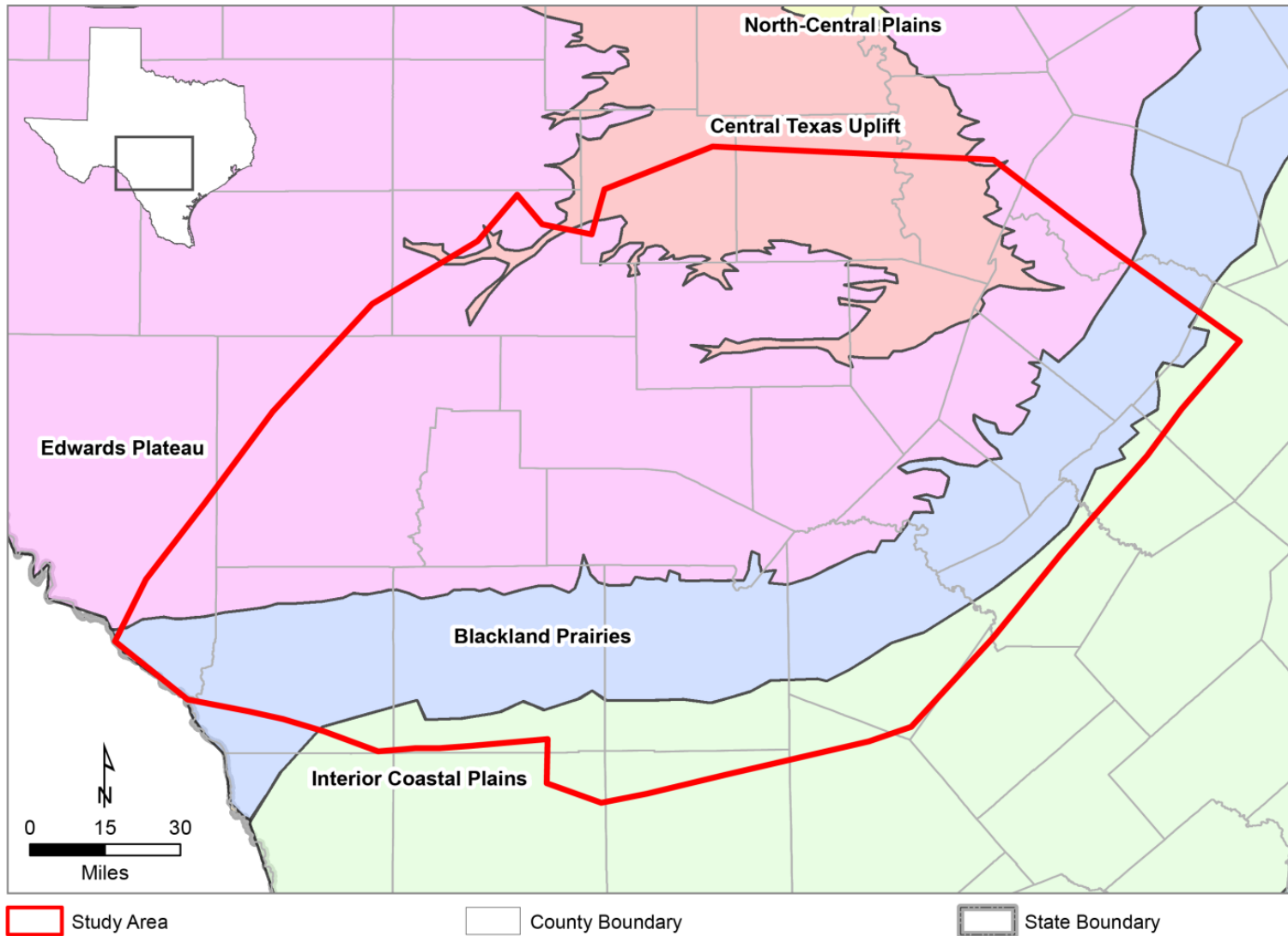

Figure 2.1.1 Physiographic provinces as defined by Wermund (1996)

Conceptual Model Report for the Hill Country Trinity Aquifer
Groundwater Availability Model

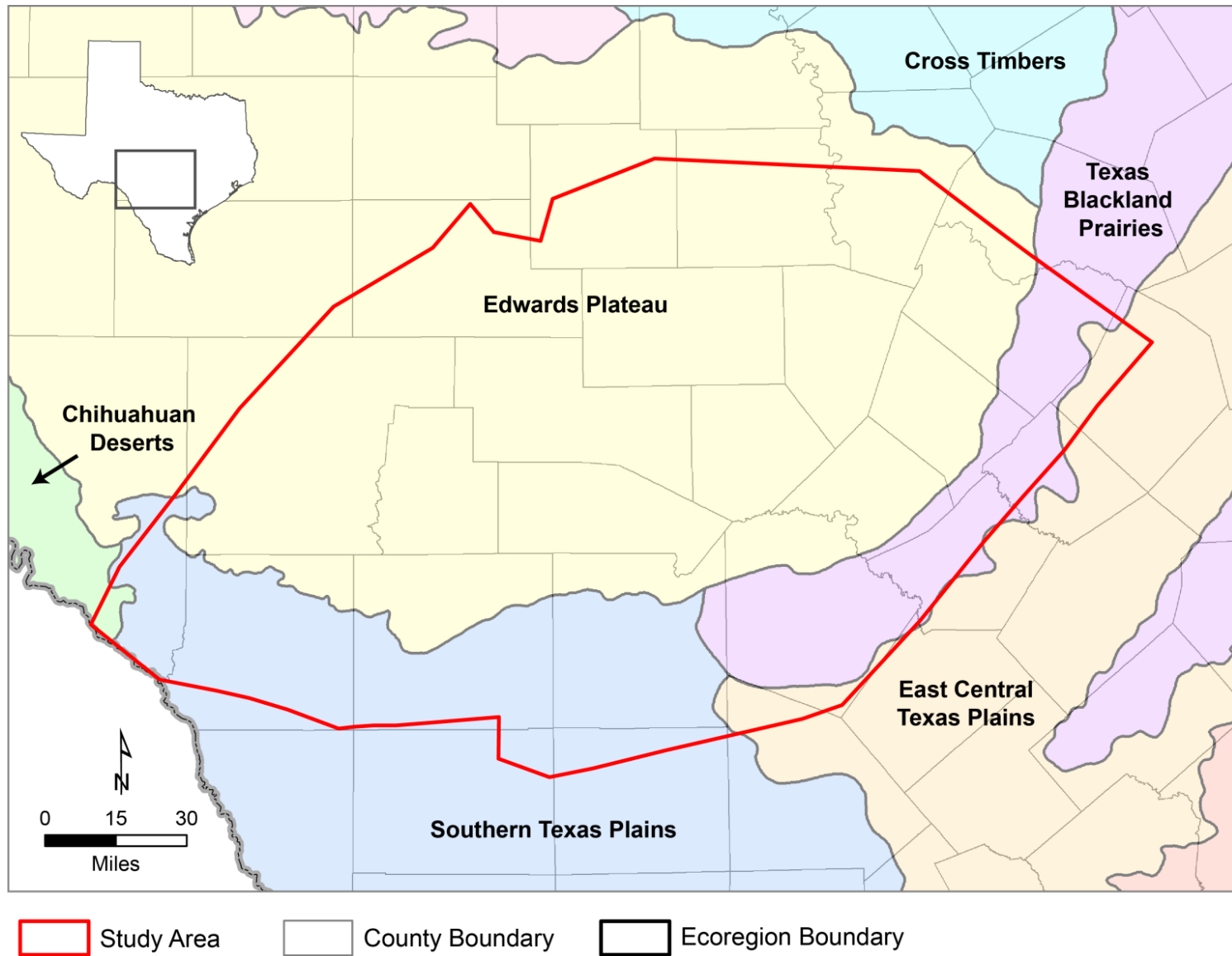

Figure 2.1.2 Level III ecological regions as defined in Griffith and others (2007).

Conceptual Model Report for the Hill Country Trinity Aquifer
Groundwater Availability Model

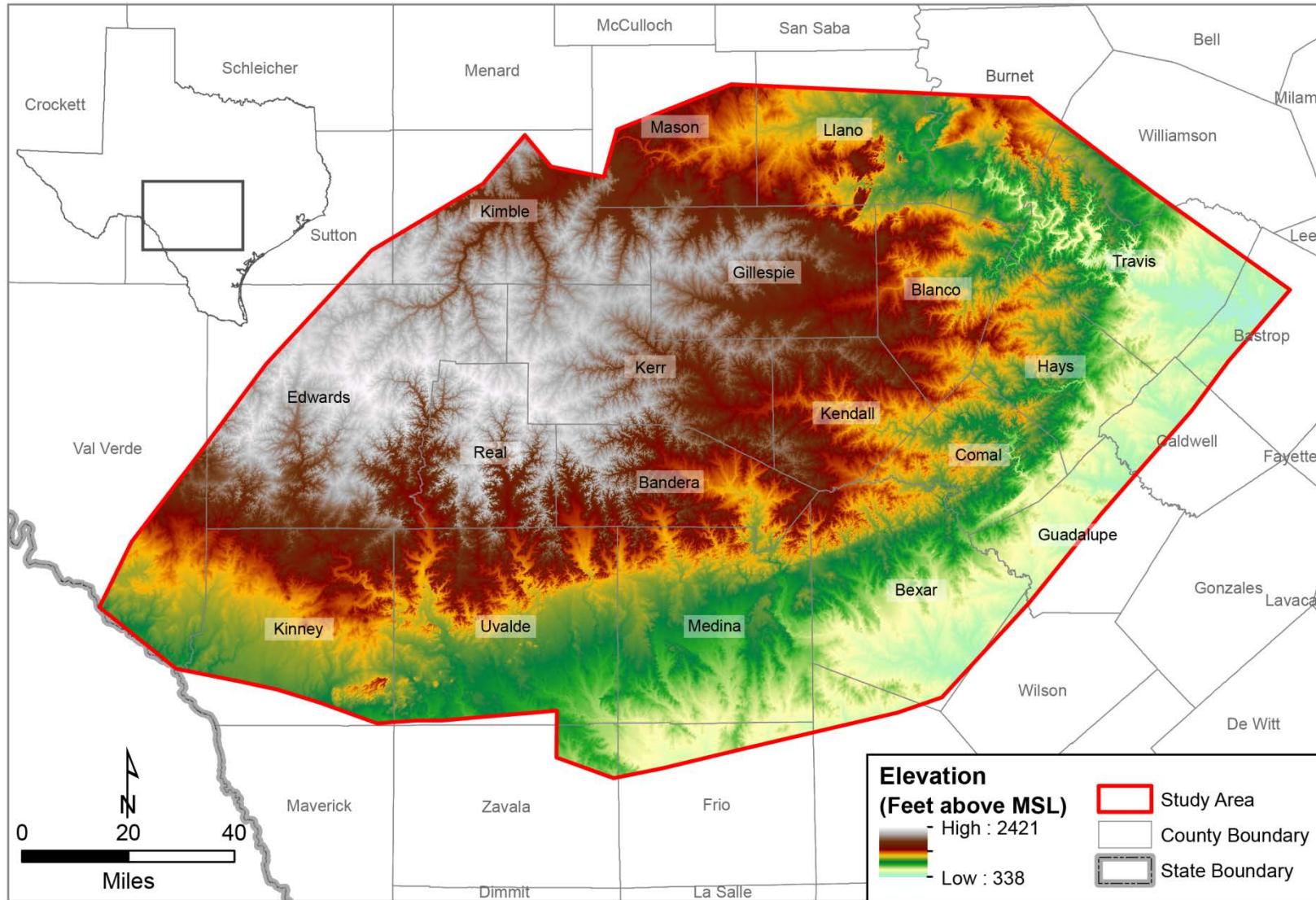

Figure 2.1.3 Topographic elevation of the study area.

Conceptual Model Report for the Hill Country Trinity Aquifer
Groundwater Availability Model

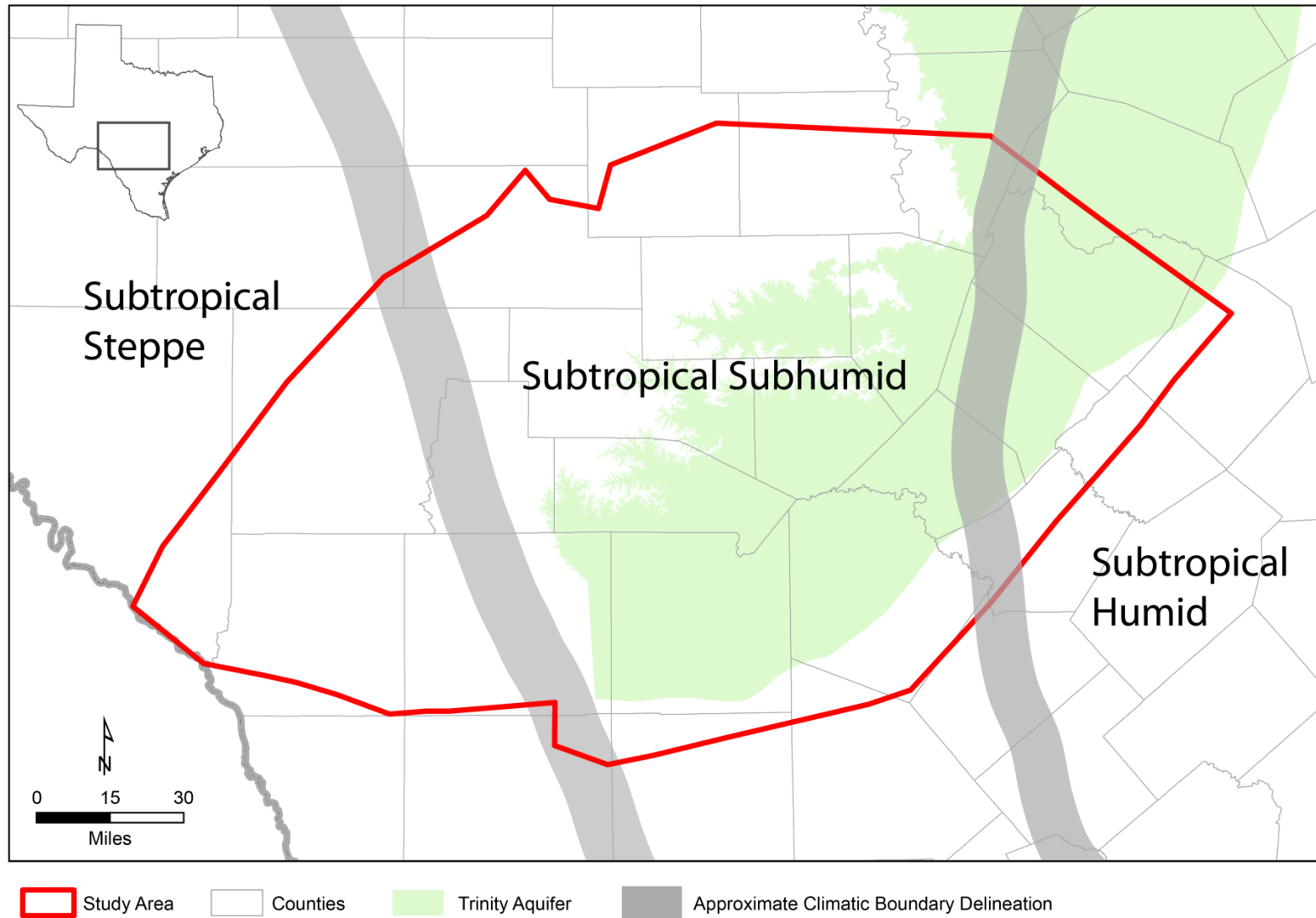

Figure 2.1.4 Climatic classifications as defined by Larkin and Bomar (1983).

Conceptual Model Report for the Hill Country Trinity Aquifer
Groundwater Availability Model

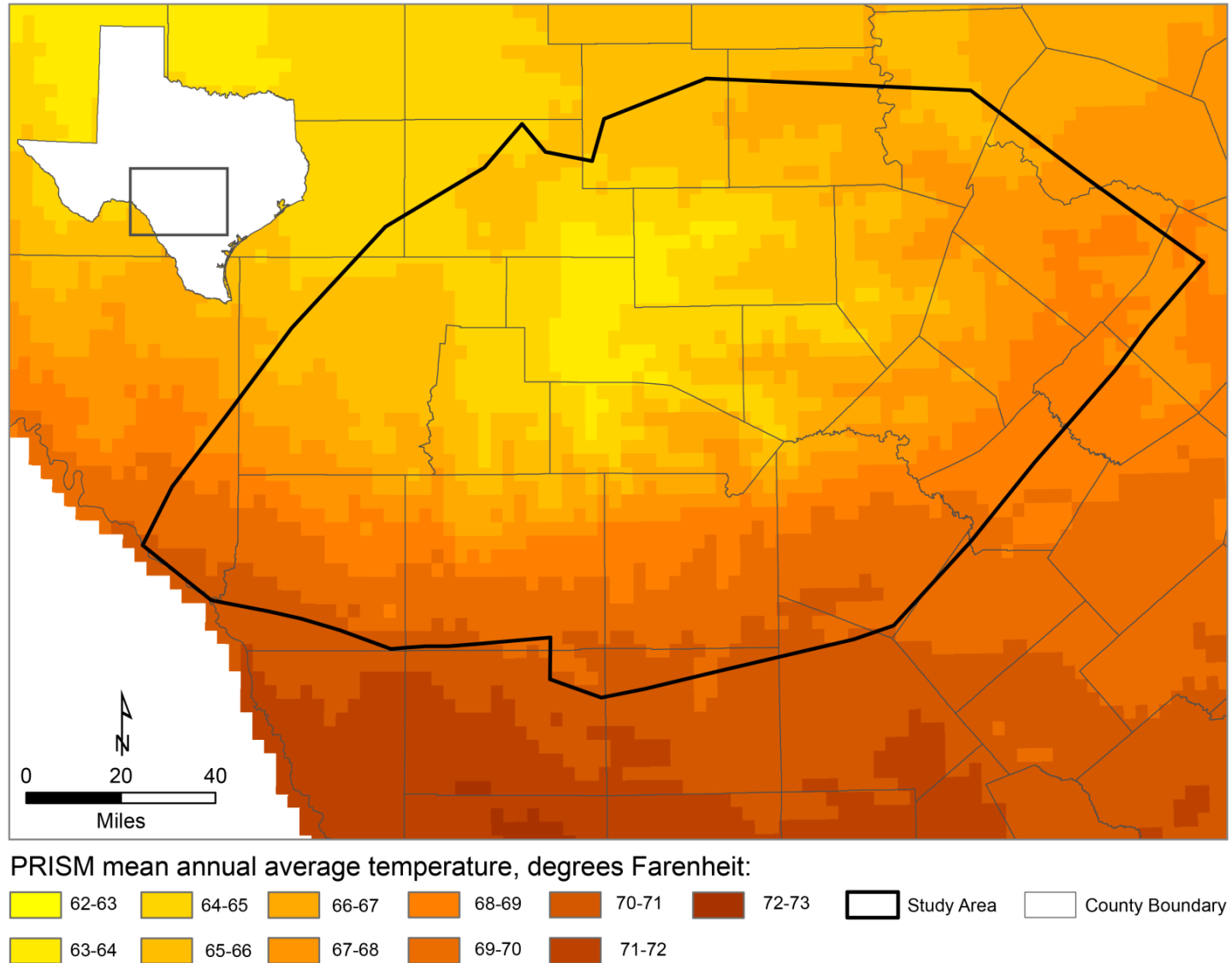

Figure 2.1.5 Mean annual average temperature data from 1980-2010 for the study area (PRISM Climate Group, 2016).

Conceptual Model Report for the Hill Country Trinity Aquifer
Groundwater Availability Model

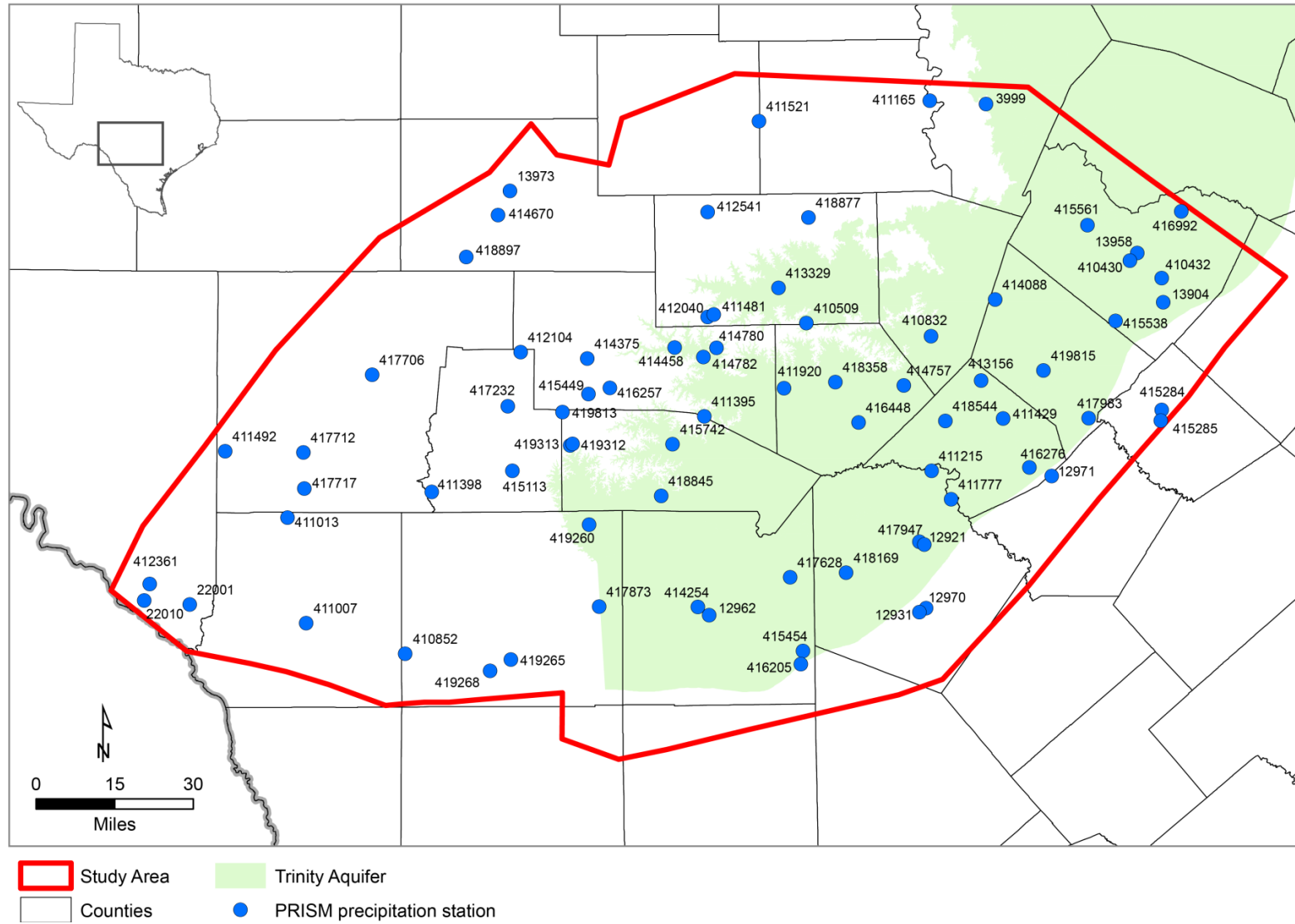

Figure 2.1.6 Locations of PRISM precipitation stations in the study area.

Conceptual Model Report for the Hill Country Trinity Aquifer
Groundwater Availability Model

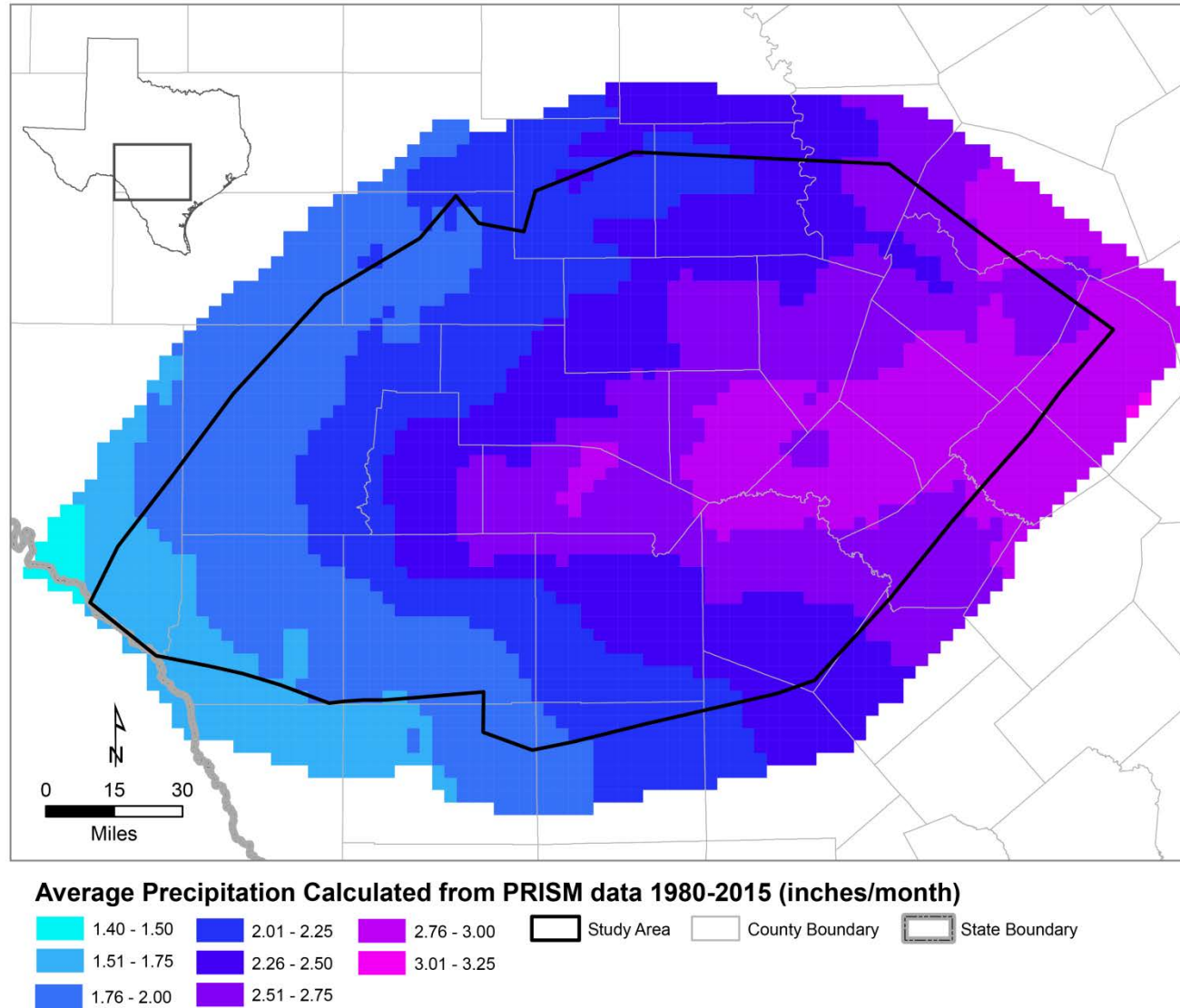

Figure 2.1.7 Average annual precipitation in the study area from 1980-2015 (PRISM Climate Group, 2016).

Conceptual Model Report for the Hill Country Trinity Aquifer Groundwater Availability Model

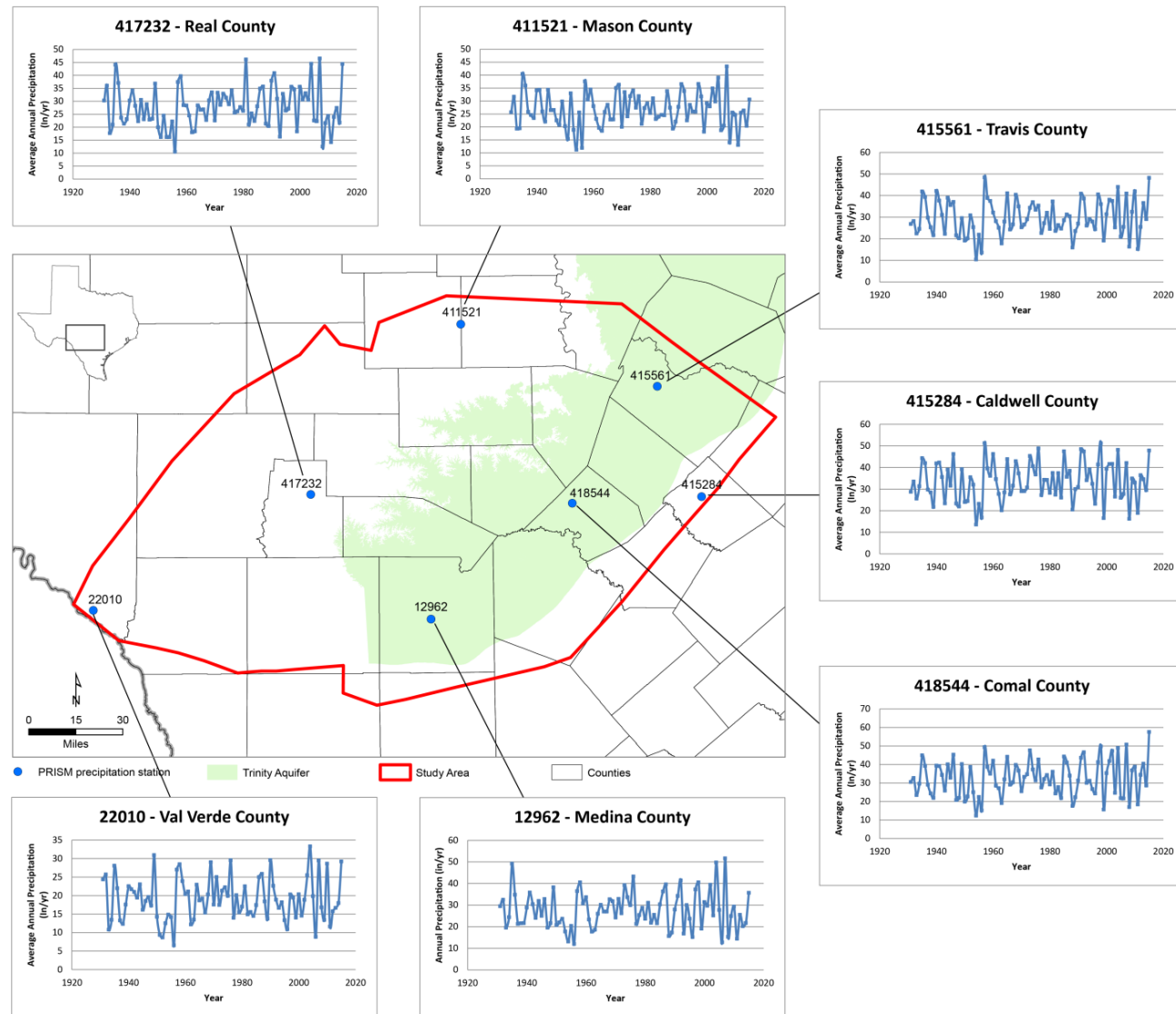

Figure 2.1.8 Examples of the historical variation in annual precipitation at selected gages from 1920-2010, as available (PRISM Climate Group, 2016).

Conceptual Model Report for the Hill Country Trinity Aquifer Groundwater Availability Model

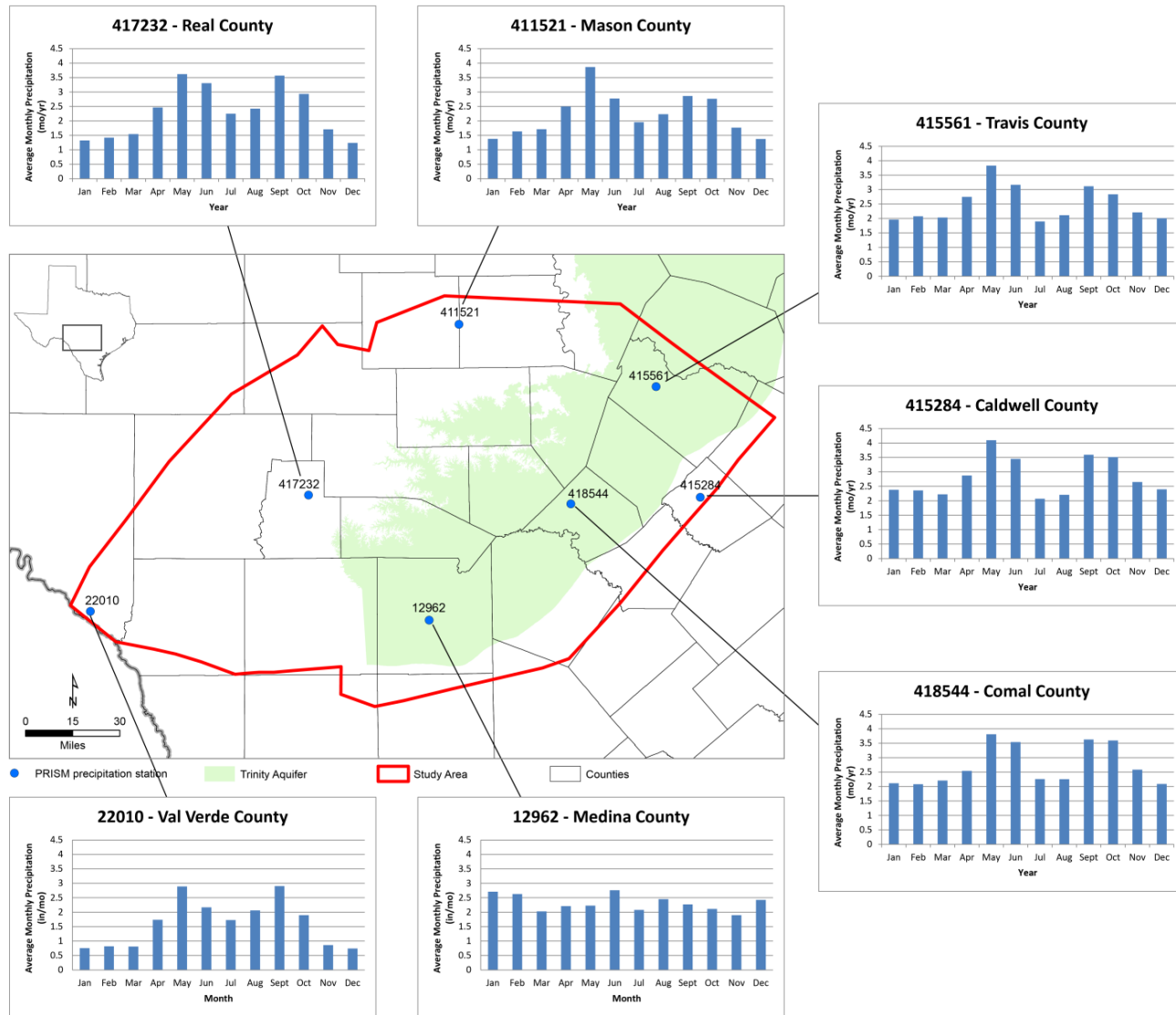

Figure 2.1.9 The long-term monthly variation in precipitation for the selected gages in Figure 2.1.8 is shown from 1920-2010, as available (PRISM Climate Group, 2016).

Conceptual Model Report for the Hill Country Trinity Aquifer Groundwater Availability Model

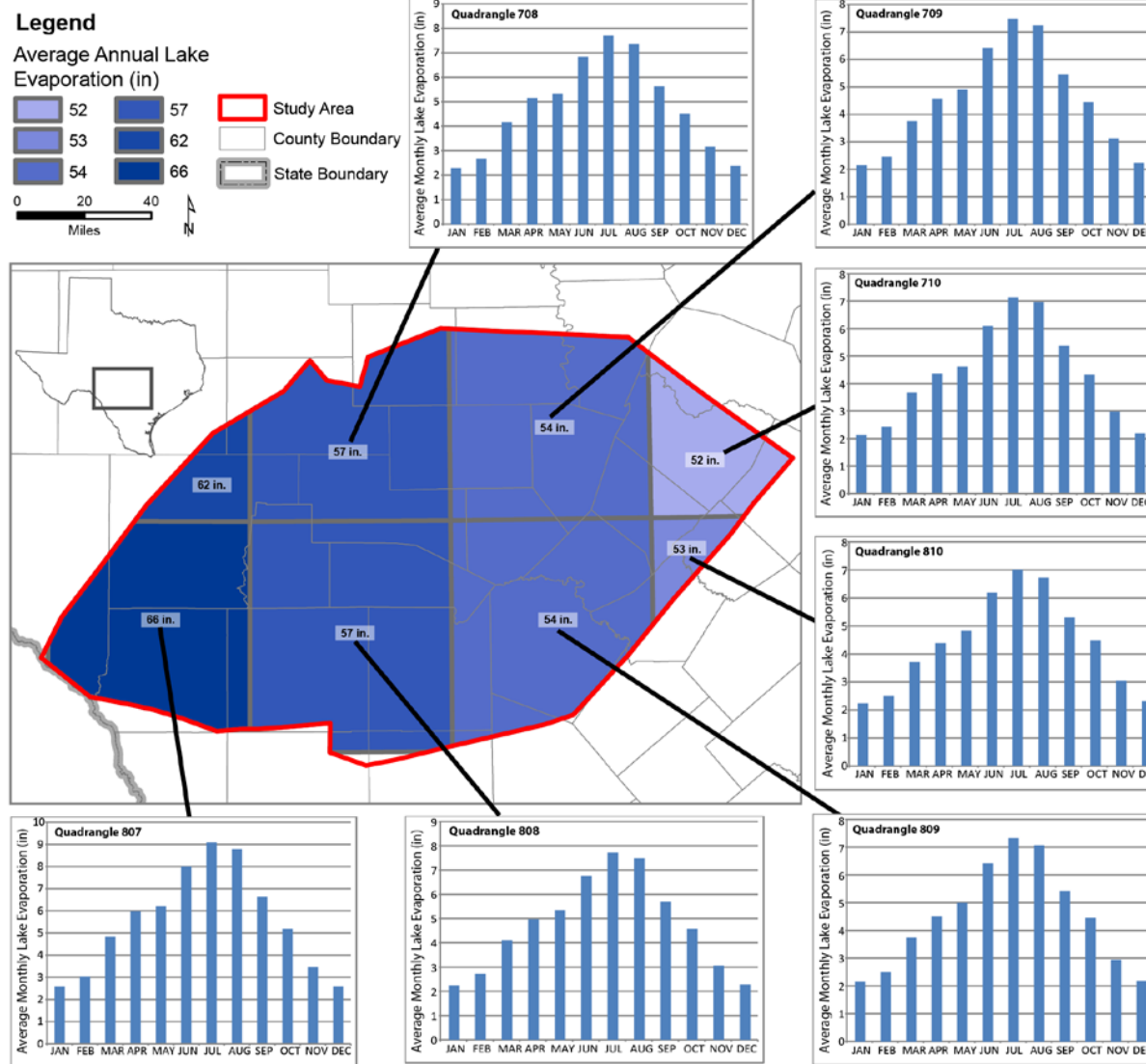

Figure 2.1.10 Average annual lake evaporation in the study area per quadrangle (map) as well as average monthly lake evaporation from January 1954 through December 2011 for each quadrangle (graphs) (Anaya and Jones, 2009).

Conceptual Model Report for the Hill Country Trinity Aquifer
Groundwater Availability Model

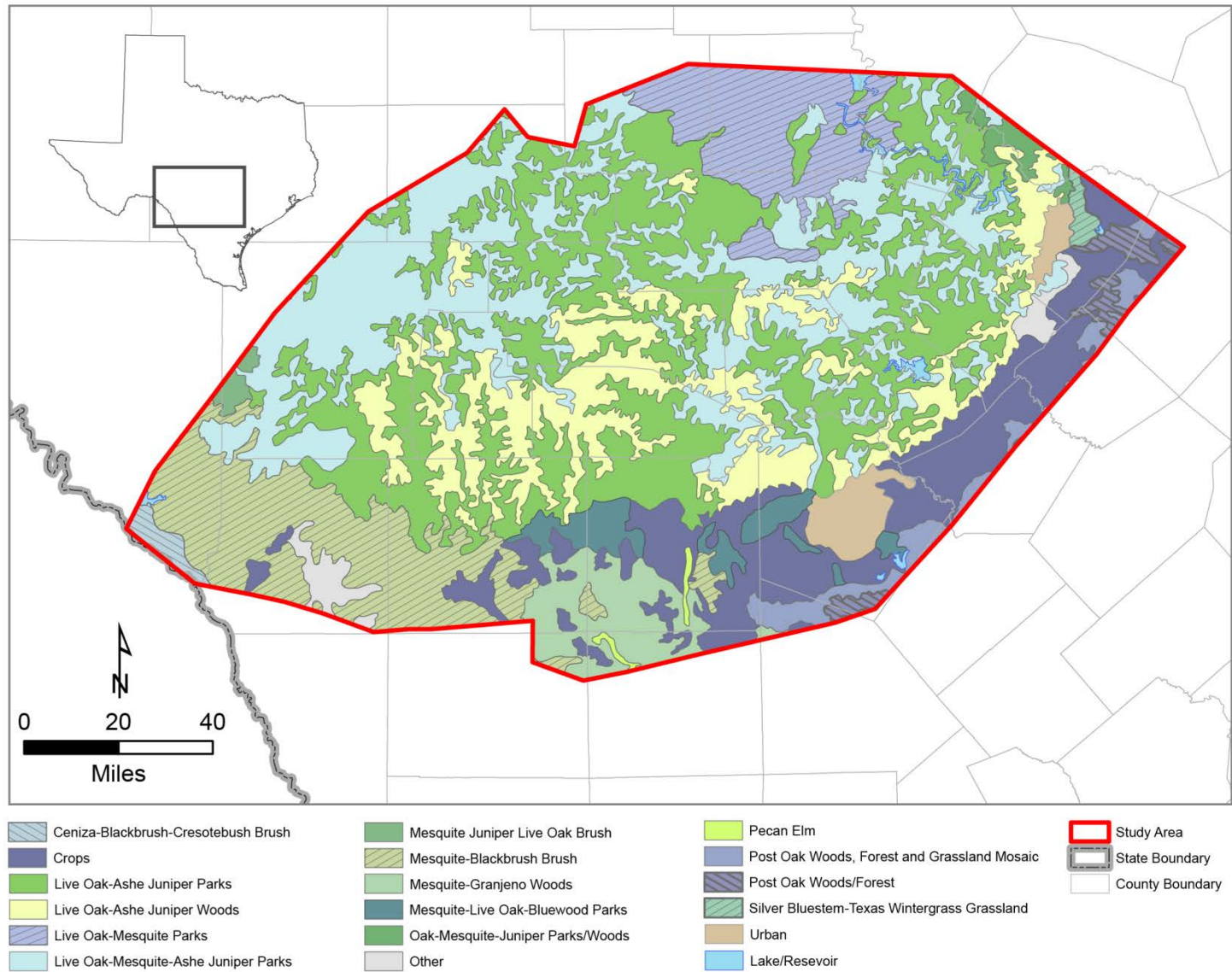

Figure 2.1.11 Map of the types of vegetation present in the study area (Frye, Brown, and McMahan, 1984).

Conceptual Model Report for the Hill Country Trinity Aquifer
Groundwater Availability Model

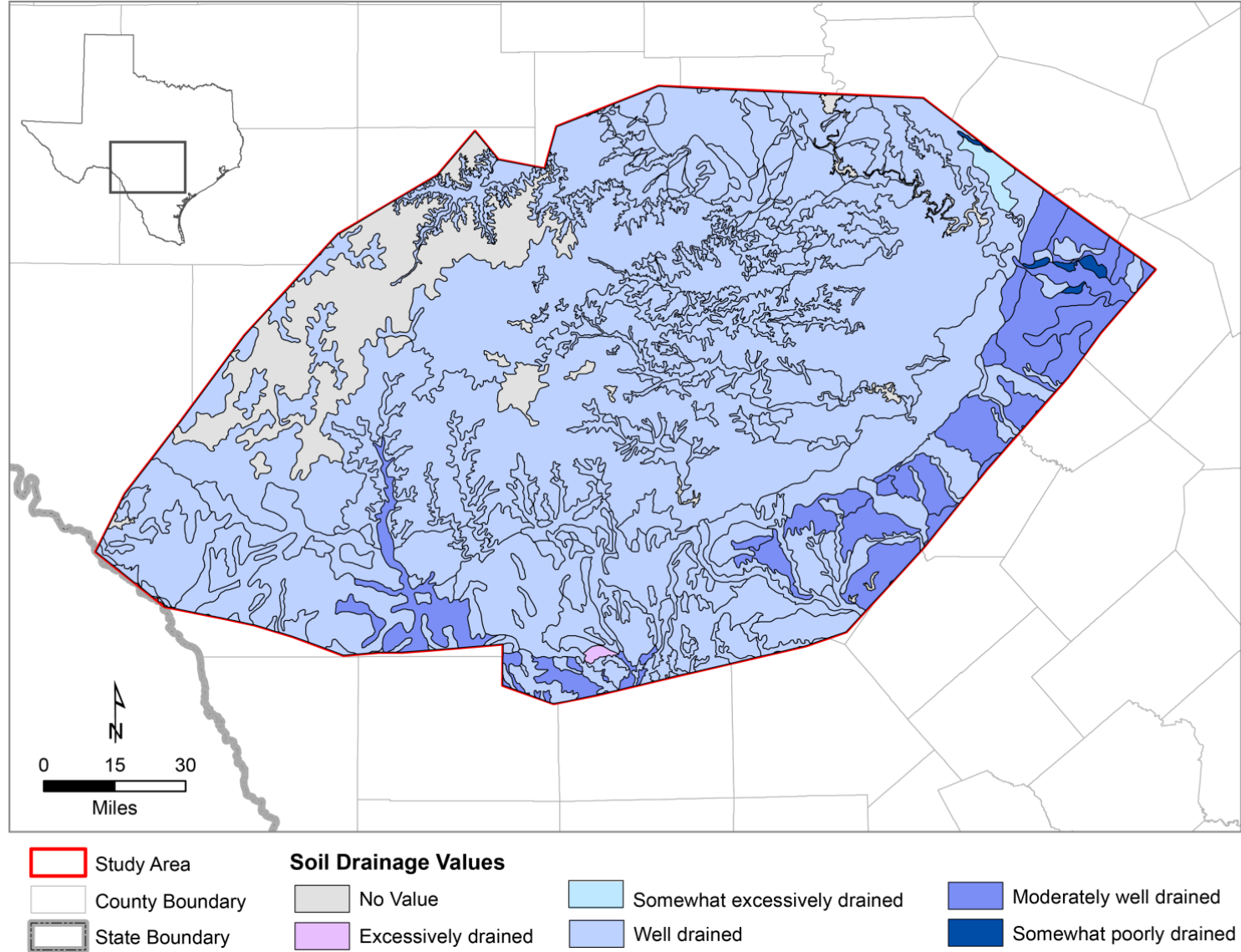

Figure 2.1.12 Map of the types of soil drainage present in the study area (USDA , Natural Resources Conservation Service, 2018).

2.2 Geology

This section provides a description of the geology within the HCT Aquifer study area. The discussion is divided into the geologic setting, surface geology, stratigraphy, and structural geology. In addition, generalized geologic cross-sections from literature have been modified for the study area and are included in this section.

2.2.1 Geologic Setting

The HCT Aquifer, as defined in George and others (2011), includes several smaller aquifers within the Trinity Group. These aquifers include the Glen Rose, Hensell, Cow Creek, and Hosston (refer to section 1.0 and 2.0 for further discussion on other aquifers within the study domain). The rocks that make up the Trinity Aquifer in this area are early to middle Cretaceous in age and lay on top of Pre-Cretaceous-age rocks (Figure 2.2.1). Cretaceous-age lithologies consist of limestone, sand, clay, gravel, and conglomerate. The HCT Aquifer crosses numerous depositional domains as shown in Figure 2.2.1 and Figure 2.2.2. These domains include Llano Uplift, Eastern Edwards (Plateau), Hill Country, Balcones Fault Zone, and Gulf Coastal Plain. In addition, there are facies markers and structural geologic features that impact deposition and geometry of the units within this study area (Figure 2.2.2 and Figure 2.2.3). These include Maverick Basin, Devils River Trend, San Marcos Arch, Ouachita-Marathon fold thrust belt, Laramide fold thrust belt, Devils River Uplift, and Balcones Fault Zone (Figure 2.2.2 and Figure 2.2.4). Figure 2.2.5, Figure 2.2.6, and Figure 2.2.7 are generalized cross-sections from Barker and Ardis (1996) and Rose (2016b) that have been modified for this study area.

We relied heavily on literature to provide geologic and tectonic information for such a large and diverse domain. For a detailed description on the geology of the HCT Aquifer domain we suggest reviewing the resources listed in Table 2.2.1.

2.2.2 Surface Geology

Over a large part of the southern end of the study area, are Post-Cretaceous rocks that include Quaternary-age alluvial and fluvial sediments, and Tertiary rocks consisting of Uvalde Gravels and Claiborne and Wilcox Groups. Upper Cretaceous rocks include the Navarro and Taylor Groups, as well as Austin and Eagle Ford Formations. Also included in the Upper Cretaceous outcrop but grouped separately in the surface geology are the Buda, and Del Rio Clay (Figure 2.2.8). Outcrop of the Edwards and Trinity rocks occurs over the majority of the study area. Pre-Cretaceous rocks crop out only in the northern portion of the study area in the vicinity of the Llano Uplift.

2.2.3 Stratigraphy/Lithology

The stratigraphy of the Trinity Groups in the Hill Country Aquifer is revealed through creek bed exposures, hillsides, roadcuts, and quarries, as well as scattered water-well cuttings and cores. Few large-scale contiguous, non-weathered exposures exist, which makes it difficult to trace out the stratal geometries (Ward and Ward, 2007). Therefore, much of what is known about these

Conceptual Model Report for the Hill Country Trinity Aquifer
Groundwater Availability Model

formations has been pieced together by correlating marker beds across large areas of the Edwards (Plateau) (Stricklin and others, 1971) in outcrop and in core.

In the HCT Aquifer region, the Pre-Cretaceous rocks that underlie the Trinity Group include Precambrian metamorphic and igneous rocks and Paleozoic sedimentary rocks. The Llano Uplift was a topographic high during the deposition of the Trinity Group. The Llano Uplift shed debris into the Trinity depositional basin. The topographic high and the variable erosion of the Llano Uplift contributed to uneven terrain at the time of Trinity Group deposition. The lateral and vertical distributions of the Trinity Group were greatly influenced by the Llano Uplift (Stricklin and others, 1971). In the vicinity of the Llano Uplift (updip) the Trinity Group thins to less than 150 feet. Beneath the Balcones Fault Zone (downdip) it thickens to greater than 1,000 feet thick and further downdip it thickens to more than 2,000-feet thick (Barker and Ardis, 1996 and this report).

The base of the HCT Aquifer is the Hosston Formation, which overlies the Pre-Cretaceous rocks. The Hosston Formation is a siliclastic siltstone and sandstone in the updip region and dolomitic mudstone and grainstone in the downdip region (Barker and Ardis, 1996). This unit varies greatly in thickness from less than 200 feet updip to greater than 1,000 feet downdip. Further updip along the southern flanks of the Llano Uplift, the Hosston Formation grades into the Sycamore Sand (Amsbury, 1974). The Sligo Formation overlies the Hosston Formation and is composed of evaporates, limestone and dolostone. Downdip, the Sligo Formation is a shallow-marine carbonate that is up to 500-feet thick. Updip, it thins to less than 250 feet where it grades into terrigenous clastics.

Above the Sligo Formation is the Hammett Shale, which is also referred to as the Pine Island Shale Member (Murray, 1961). This unit is a mixture of clay, silt, mud, dolomite, and carbonate (Amsbury, 1974). The unit thins to near zero updip and thickens to greater than 100 feet downdip. The Hammett Shale has a transitional boundary with the overlying Cow Creek Formation. The Hammett-Cow Creek contact is arbitrarily determined to be the first well-developed limestone as you transition from shale (Lozo and Stricklin, 1956). The Cow Creek Formation is a fine- to coarse-grained calcarenitic limestone at the bottom that transitions into silty carbonate grains throughout the middle and consists of cross-bedded beach coquina at the top (Barker and Ardis, 1996). The Cow Creek Formation thins to near zero updip and thickens to greater than 300-feet downdip (Imlay, 1945). Overlying the Cow Creek Formation is the Hensell Formation. For much of the HCT Aquifer region, the Hensell Formation is comprised of weakly cemented clay, quartz, and calcareous sand (Inden, 1974). In some parts of the HCT Aquifer region, especially the farthest downdip portions and southern Bexar County, the Hensell Formation (referred to Bexar Shale in these locations) is comprised of a mixture of dark mudstone, clay, and shale (Barker and Ardis, 1996). According to Loucks (1977), the shales in the Hensell Formation are the fine-grained, marine equivalent of the near-shore (updip), terrigenous sands. The Hensell Formation varies in thickness from less than 50 feet in the updip to greater than 200 feet thick in the downdip (Imlay, 1945).

Above the Hensell Formation lies the Glen Rose Formation. This consists of the formal subdivisions the lower member of the Glen Rose Formation and the upper member of the Glen Rose Formation. The upper member of the Glen Rose Formation represents the top of the Trinity

Conceptual Model Report for the Hill Country Trinity Aquifer
Groundwater Availability Model

Group for much of the Trinity Aquifer domain. Lozo and Stricklin (1956) and Stricklin and others (1971) established these informal lithostratigraphic subdivisions of the Glen Rose Formation that Scott and Filkorn (2007) formalized. These subdivisions are now used throughout the updip and downdip regions of the HCT Aquifer region. The boundary between the two members was put at the top of a widespread, meter-thick unit rich in the small bivalve “*Corbula*” (*Eoursivivas harveyi*). Both the lower and upper members of the Glen Rose Formation formations are comprised of cyclic depositional units on several scales. Lithologic units include shallow-water wackestone, packstone, and grainstone, as well as finely crystalline dolostone beds and a terrigenous claystone (Ferrill and others, 2011). Where the Glen Rose Formation crops out in the Hill Country, the lower member of the Glen Rose Formation is about 260-feet thick (Abbott, 1966), and the upper member of the Glen Rose Formation is about 480-feet thick (estimated from Abbott, 1966; Stricklin and others, 1971; and Farlow and others, 2006). The Glen Rose Formation in the subsurface and downdip is much thicker, in excess of 1,500 feet (Welder and Reeves, 1964).

For most of the Hill Country, the top of the Trinity Group is overlain by the Walnut Formation, which, in turn, is overlain by the Kainer Formation of the Edwards Group. The Edwards Group consists of massive, porous, highly fractured lower Cretaceous limestone with thicknesses that range from less than 500-feet thick in the updip and greater than 1,000 feet in the downdip (Rose, 1972). Above the Edwards Group is the Georgetown Formation. The Georgetown Formation is comprised of discontinuous beds of alternating thin, fine-grained limestone or marly limestone. It ranges in thickness from less than 60 feet in the updip and greater than 100 feet to absent in other parts of the Hill Country region (Rose, 1972).

2.2.4 Structural Geology

Rocks of both the Edwards and Trinity aquifers crop out in the Edwards (Plateau) region of Texas, and their southern outcrop boundary is within the Balcones Fault Zone (Figure 2.2.4). The tectonic history and structural development of the Balcones Fault Zone have been documented extensively (Cope, 1880; Hill, 1889, 1890; Foley, 1926; Weeks, 1945; George and others, 1952; Sandidge, 1959; Murray, 1961; Young, 1972; Rose, 1986a; Collins, 2000; Ferrill and others, 2004, 2008, 2009, 2011, 2012; Ferrill and Morris, 2008; Morris and others, 2009a, b, 2014; Zahm and others, 2010). The rocks in this study domain have experienced a relatively simple stress and deformation history dominated by southeast-directed extension toward the Gulf of Mexico basin. The Balcones Fault Zone formed in the Oligocene, accommodating subsidence of the northwest margin of the Gulf of Mexico basin (Foley, 1926; Murray, 1961; Young, 1972) and uplift of the Edwards Plateau (Rose, 2016). The system marks the boundary between flat-lying, stable strata of central Texas and the gentle, coastward-dipping sedimentary rocks that are subsiding toward the Gulf of Mexico. The Balcones Fault Zone changes trend from nearly east-west between Del Rio and San Antonio to nearly north-south between Austin and Dallas. In the Hill Country region, the Balcones Fault Zone changes trend by 30° from 080° west of San Antonio to 050° northeast of San Antonio. This fault zone is a 15- to 18-mile-wide en echelon (refers to closely-spaced, parallel or subparallel, overlapping or step-like faults or extension fractures in rock) system of mostly south-dipping normal faults that formed during the middle-to-late Tertiary (Foley, 1926; Murray, 1961; Young, 1972; Grimshaw and Woodruff (1986);

Conceptual Model Report for the Hill Country Trinity Aquifer
Groundwater Availability Model

Collins (1995); Collins (2004); Collins and Hovorka (1997)). The zone has a maximum total displacement across its extent of about 1500 feet (Weeks, 1945). The larger normal faults in the Balcones Fault Zone have displacements of 100–1,000 feet or more (Hill, 1889, 1890; Hovorka and others, 1998; Collins, 2000). Although the overall geometry of the Balcones Fault Zone parallels the strike of the Mesozoic–Paleozoic unconformity (top of Ouachita orogen rocks) and is indirectly controlled by the relict Ouachita structure, faults in the systems have orientations that accommodated Tertiary regional extension. Individual fault and fracture strikes are relatively consistent throughout the region, with an average strike of between 055° and 065° (Ferrill and Morris, 2008; Ferrill and others, 2011; Morris and others, 2014; McGinnis and others, 2015). Faults are generally considered to be steep ($60\text{--}70^{\circ}$) to nearly vertical based on local measurements and nearly linear fault traces in areas of significant topographic relief (Hill, 1889; McGinnis and others, 2015). Offset of Cretaceous platform carbonate strata (Rose, 1972) across the Balcones Fault Zone, including the Edwards and Trinity aquifers, resulted in a broad, weathered escarpment of vegetated limestone hills rising from the predominantly clastic coastal plains to the uplands of the Texas Craton. Within the fault system, the dip of bedding varies from gentle coastward to nearly horizontal, with occasional localized dip of hanging wall beds northward into some faults. Faulting has been interpreted as being rooted in the deeply buried foreland-basin sediments of the Ouachita orogeny (Murray, 1956).

Faults of the Balcones Fault Zone exert important first-order controls on fluid flow within the Trinity and the overlying Edwards aquifers, however, their hydrologic properties are a source of uncertainty in describing groundwater flow in this region. The faults that make up the Balcones Fault Zone juxtapose both permeable and relatively impermeable hydrogeologic units, they cause substantial structural thinning of the lower Cretaceous strata, and they provide potential pathways for infiltration of surface water into the groundwater systems and for lateral and vertical movement of groundwater (Ferrill and Morris, 2008; Ferrill and others, 2008, 2011; McGinnis and others, 2015). Extensional deformation in the Balcones Fault Zone has produced a network of faults likely to influence intra-aquifer permeability due to fault zone processes producing permeability anisotropy with maximum transmissivity parallel to fault strike (Ferrill and others, 2009). Displacement on these faults has thinned the aquifer along each fault, further restricting aquifer connectivity perpendicular to fault strike. Displacement on the large faults can thin the Trinity units by 50–100 percent of their total stratal thickness, and juxtapose Pre-Cretaceous rocks against Trinity strata or Trinity strata against Edwards strata. The impact of this scale of offset is that potential water-bearing units can be absent in places or there is the opportunity for interaquifer communication. Understanding the fault network in the Balcones Fault Zone is a daunting task, however, it is a necessary effort in order to reduce uncertainty in hydrologic models for this area.

Conceptual Model Report for the Hill Country Trinity Aquifer
Groundwater Availability Model

Table 2.2.1 Literature used for geologic and hydrogeologic context.

Structural/Tectonic	Stratigraphic/Lithologic
Barnes (1977) Del Rio Sheet	Abbott (1966)
Barnes (1979) Seguin Sheet	Amsbury (1974)
Barnes (1980) Sonora Sheet	Amsbury (1988)
Barnes (1981a) Llano Sheet	Amsbury (1996)
Barnes (1981b) Austin Sheet	Amsbury and Jones (1996)
Barnes (1983) San Antonio Sheet	Barker and Ardis (1996)
Collins (2000)	Barnes (1977) Del Rio Sheet
Collins and Hovorka (1997)	Barnes (1979) Seguin Sheet
Cope (1880)	Barnes (1980) Sonora Sheet
Ewing (1991)	Barnes (1981a) Llano Sheet
Ferrill and others (2009)	Barnes (1981b) Austin Sheet
Ferrill and others (2008)	Barnes (1983) San Antonio Sheet
Ferrill and others (2011)	Bebout and Loucks (1974)
Ferrill and Morris (2008)	Bebout (1977)
Ferrill and others (2004)	Bebout and others (1981)
Ferrill and others (2012)	Farlow and others (2006)
Flawn and others (1961)	Flawn and others (1961)
Foley (1926)	Hill (1891)
Fratesi and others (2015)	Imlay (1945)
George and others (1952)	Inden and Moore (1983)
Halbouty (1966)	Loucks (1977)
Hill (1889)	Lozo and Smith (1964)
Hill (1890)	Phelps and others (2014)
Hovorka and others (1998)	Phelps (2011)
Laubach and Jackson (1990)	Rose (1986b)
McGinnis and others (2015)	Rose (1972)
Morris and others (2009a)	Rose (2016a)
Morris and others (2009b)	Rose (2016b)
Murray (1961)	Scott (2007)
Rose (1986a)	Scott and Filkorn (2007)
Rose (1972)	Smith and others (2000)
Sandidge (1959)	Stricklin and Amsbury (1974)
Weeks (1945)	Stricklin and Smith (1973)
Young (1972)	Stricklin and others (1971)
Zahm and others (2010)	Tucker (1962)
Hydrostratigraphic/Hydrogeologic	Ward and Ward (2007)
Barker and Ardis (1996)	Welder and Reeves (1964)
Clark and others (2016)	Wierman and others (2010)
Fratesi and others (2015)	Winter (1961)
Hovorka and others (1998)	
Johnson and others (2010a,b)	
Wierman and others (2010)	

Conceptual Model Report for the Hill Country Trinity Aquifer
Groundwater Availability Model

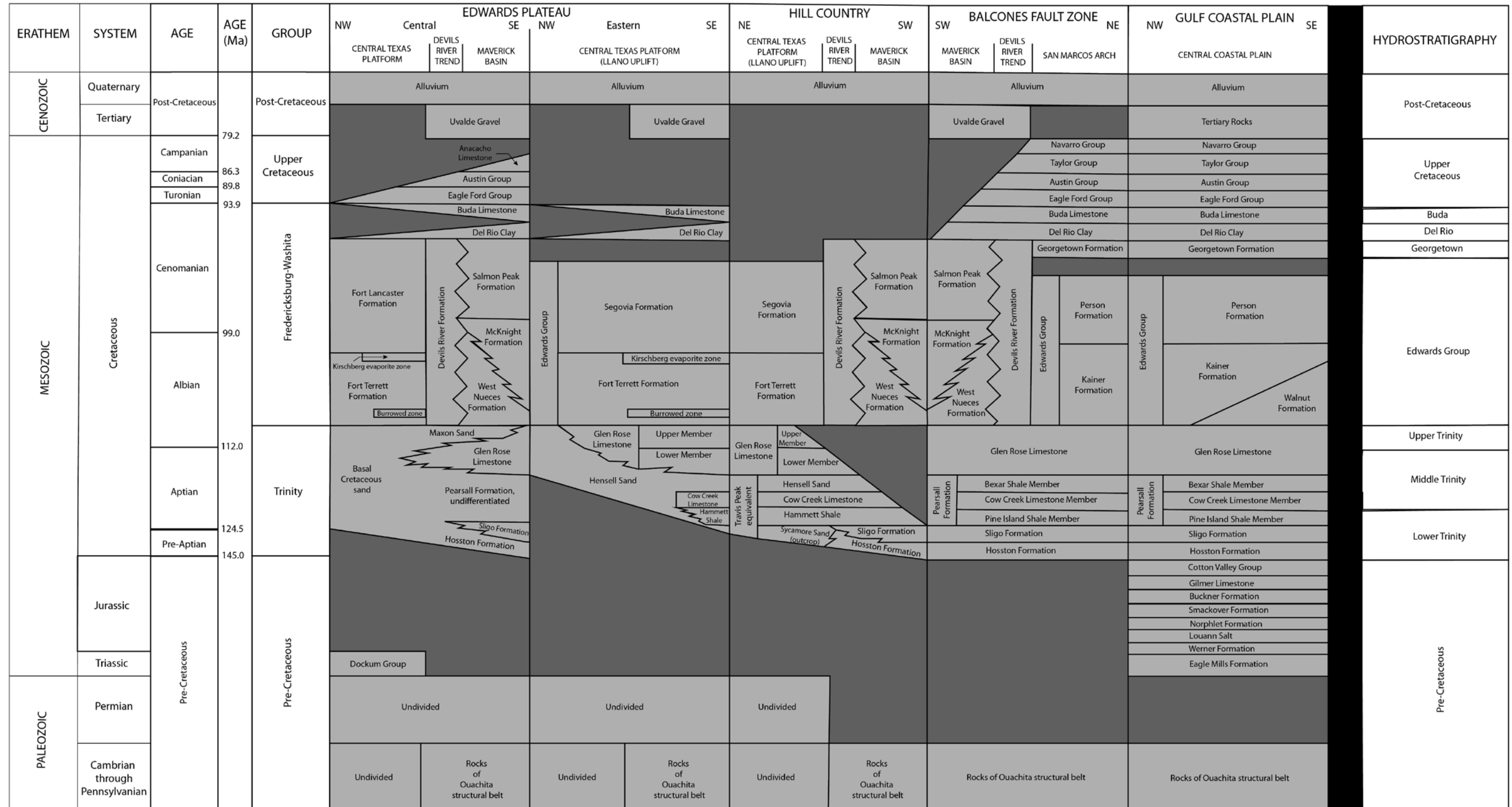

Figure 2.2.1 Stratigraphic and hydrostratigraphic column of the Hill Country. Stratigraphic units are grouped into depositional domains. (Modified from Barker and Ardis, 1996 and Rose, 2016).

Conceptual Model Report for the Hill Country Trinity Aquifer
Groundwater Availability Model

This page is intentionally blank.

Conceptual Model Report for the Hill Country Trinity Aquifer
Groundwater Availability Model

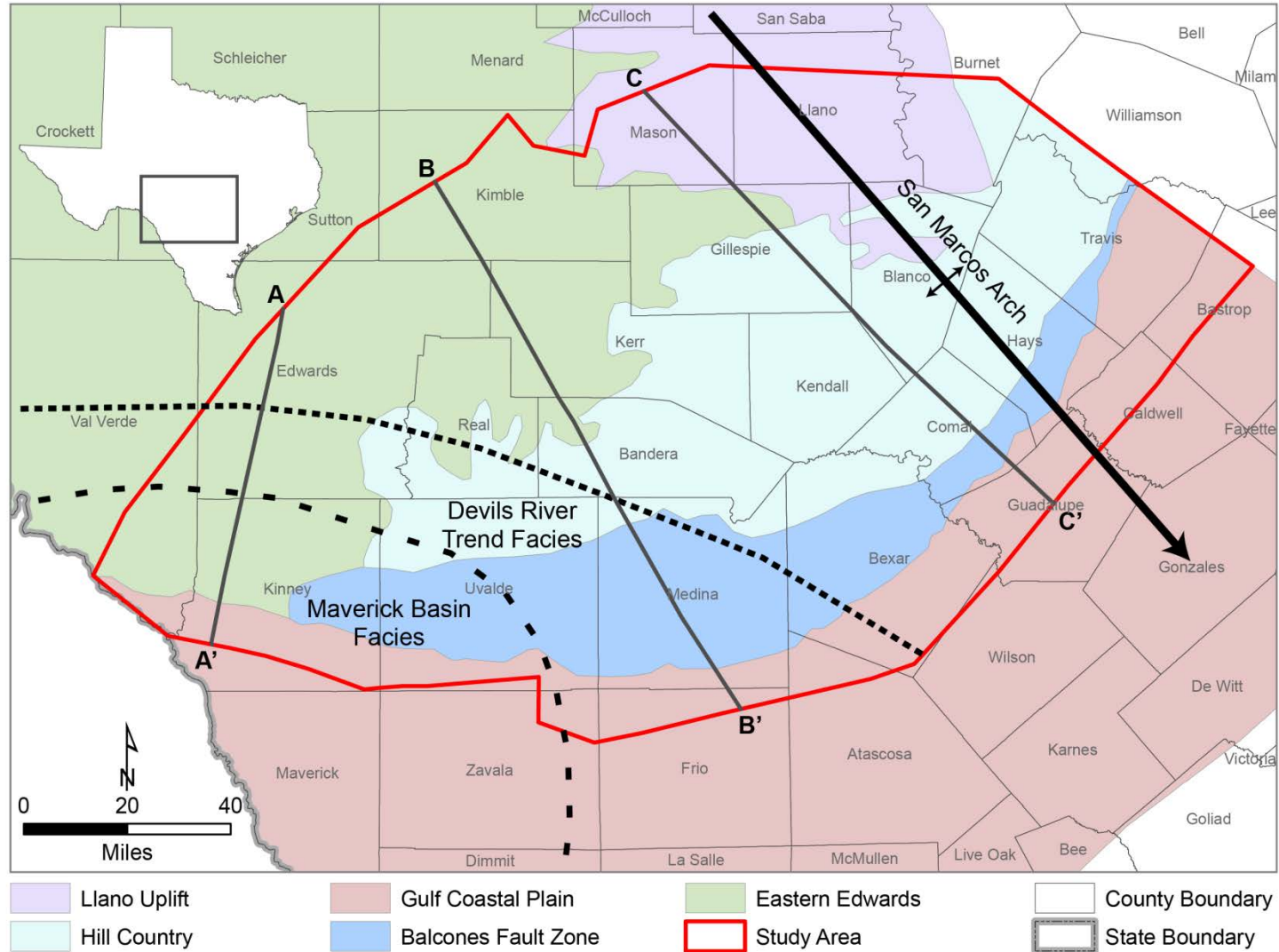

Figure 2.2.2 Map showing depositional domains as defined by Barker and Ardis, 1996 and Rose, 2016. Facies markers (Maverick Basin and Devils River Trend) are also shown as well as San Marcos Arch. Figure 2.2.1 references these domains and facies for the stratigraphic nomenclature of the study area.

Conceptual Model Report for the Hill Country Trinity Aquifer
Groundwater Availability Model

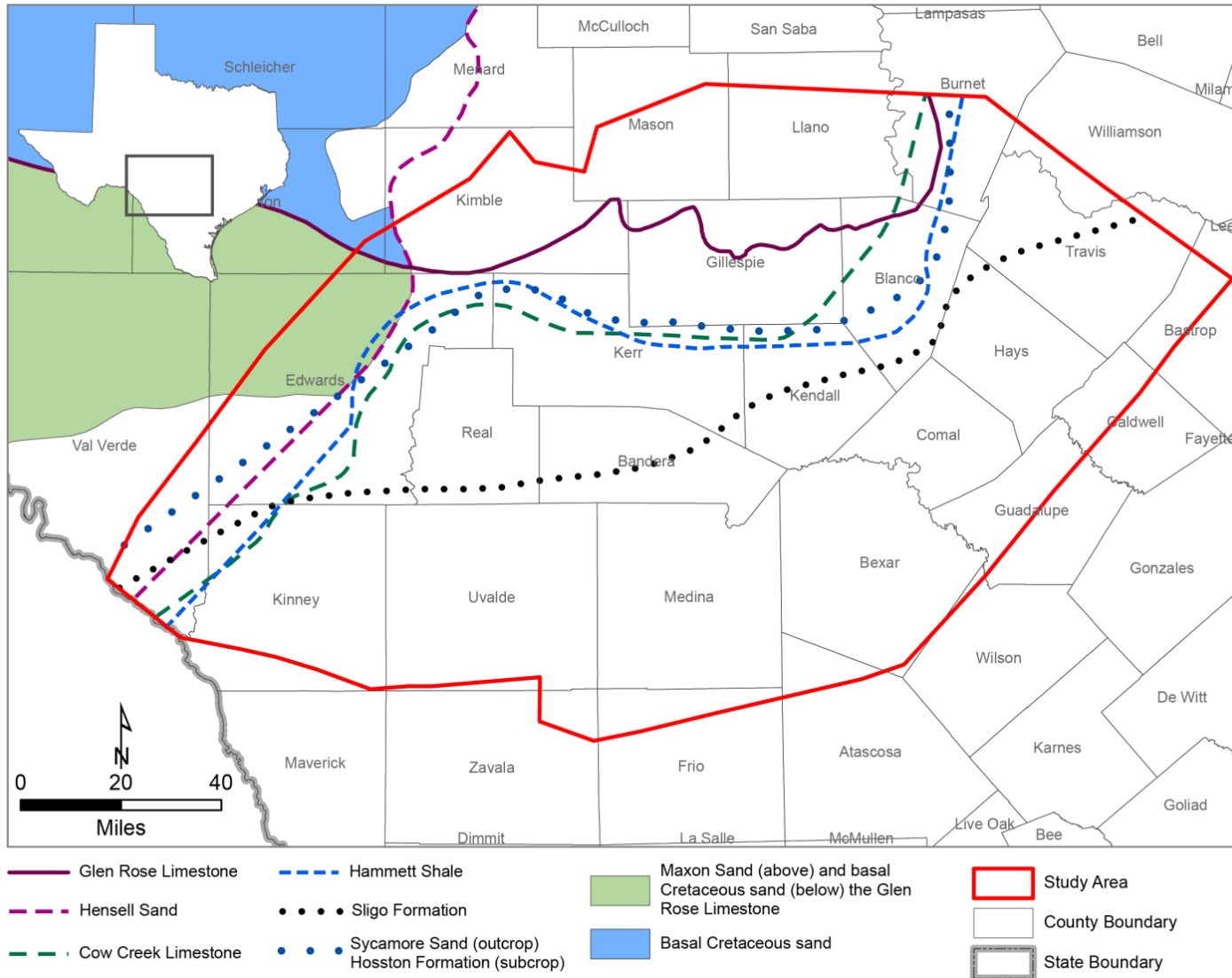

Figure 2.2.3 Updip limits and lateral distribution of Trinity units across study area. Modified from Figure 8 in Barker and Ardis (1996).

Conceptual Model Report for the Hill Country Trinity Aquifer
Groundwater Availability Model

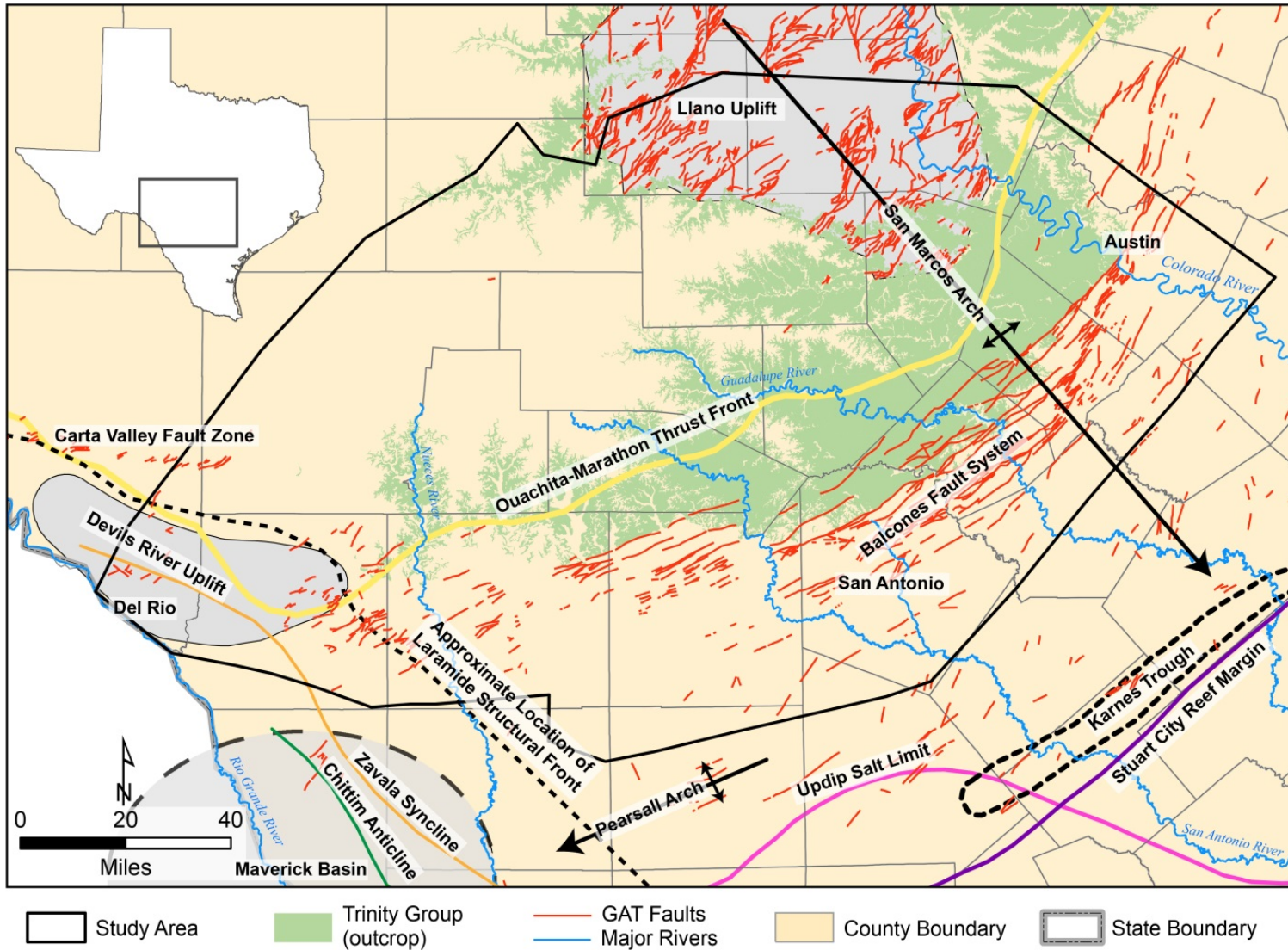

Figure 2.2.4 Geologic and tectonic synthesis map showing Trinity Group outcrop. Modified from figure 1 in Ferrill and others, 2014, 2017a and b.

Conceptual Model Report for the Hill Country Trinity Aquifer
Groundwater Availability Model

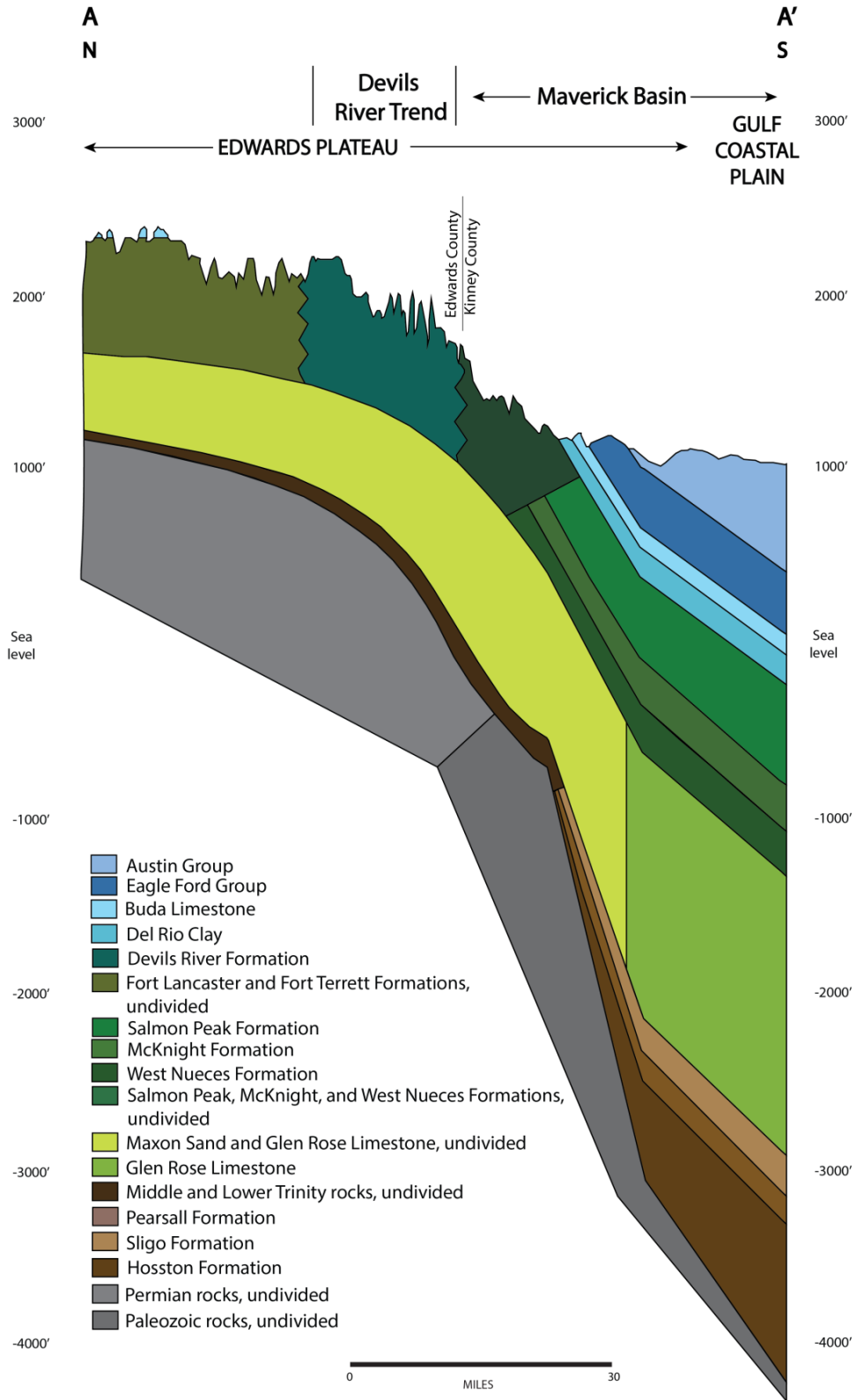

Figure 2.2.5 Generalized geologic cross-section A-A' modified from Barker and Ardis (1996). Location of section on Figure 2.2.1.

Conceptual Model Report for the Hill Country Trinity Aquifer Groundwater Availability Model

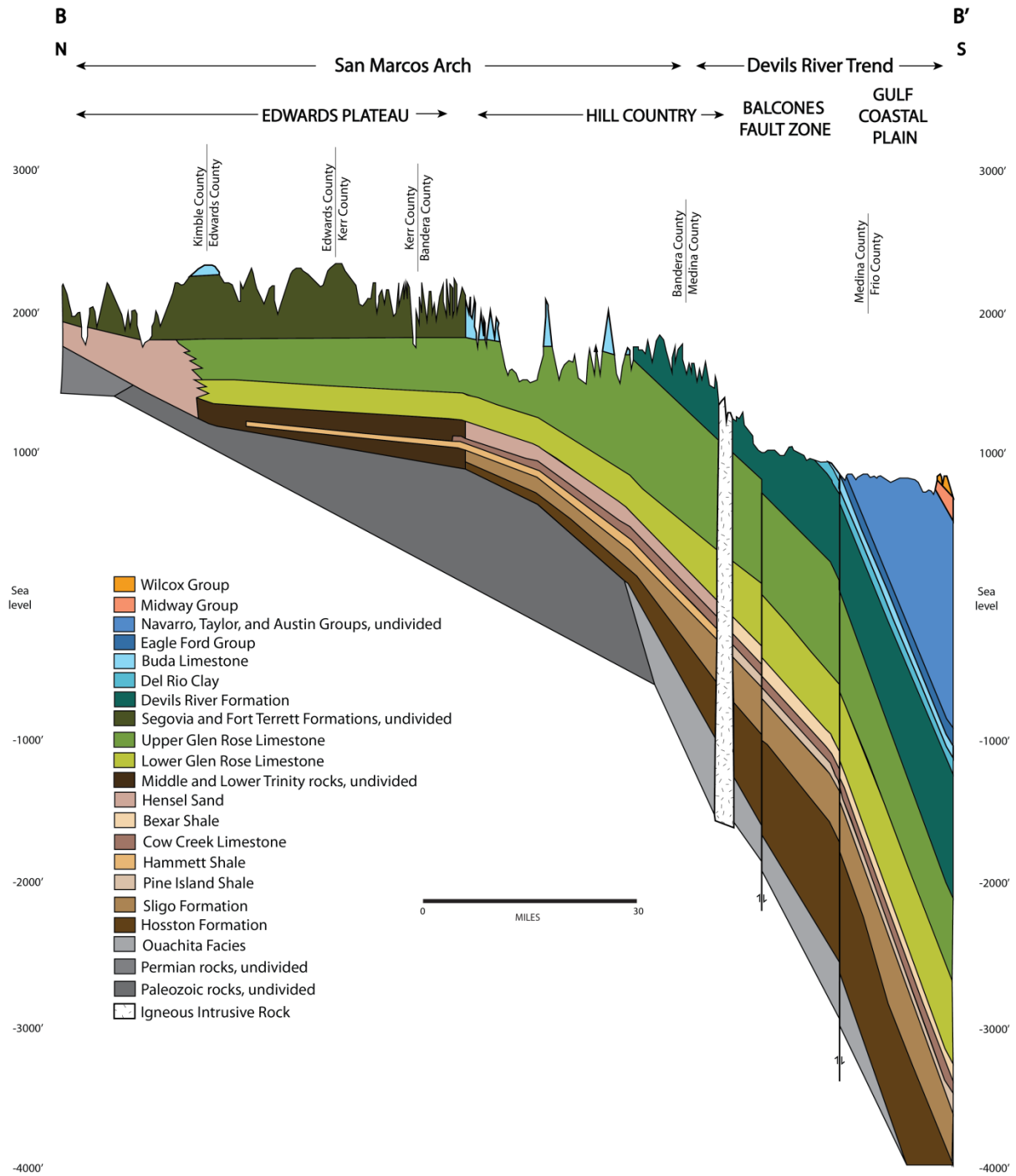

Figure 2.2.6 Generalized geologic cross-section B-B' modified from Barker and Ardis (1996). Location of section on Figure 2.2.1.

Conceptual Model Report for the Hill Country Trinity Aquifer
Groundwater Availability Model

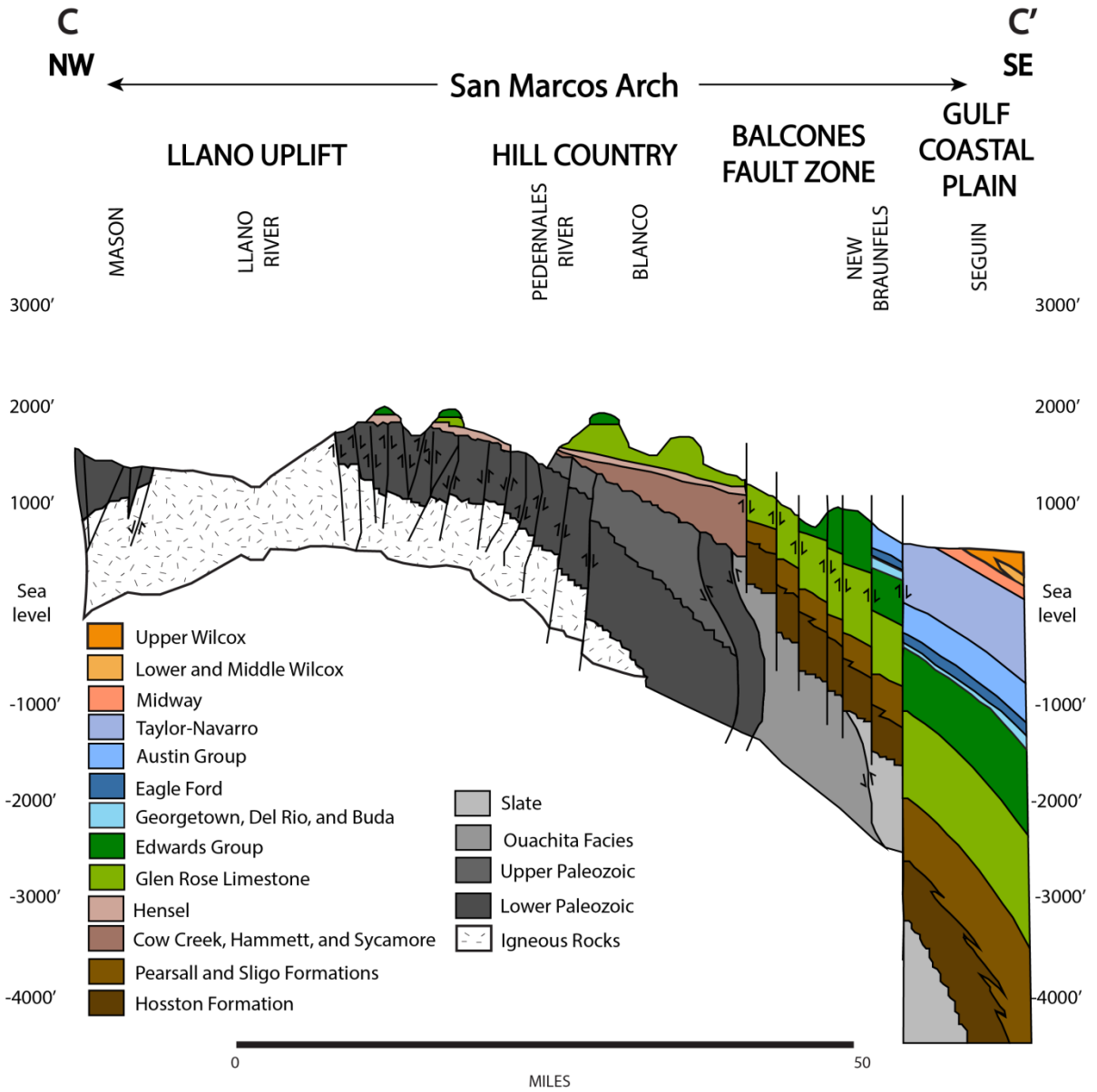

Figure 2.2.7 Generalized geologic cross-section C-C' modified from Rose (2016a). Location of section on Figure 2.2.1.

Conceptual Model Report for the Hill Country Trinity Aquifer
Groundwater Availability Model

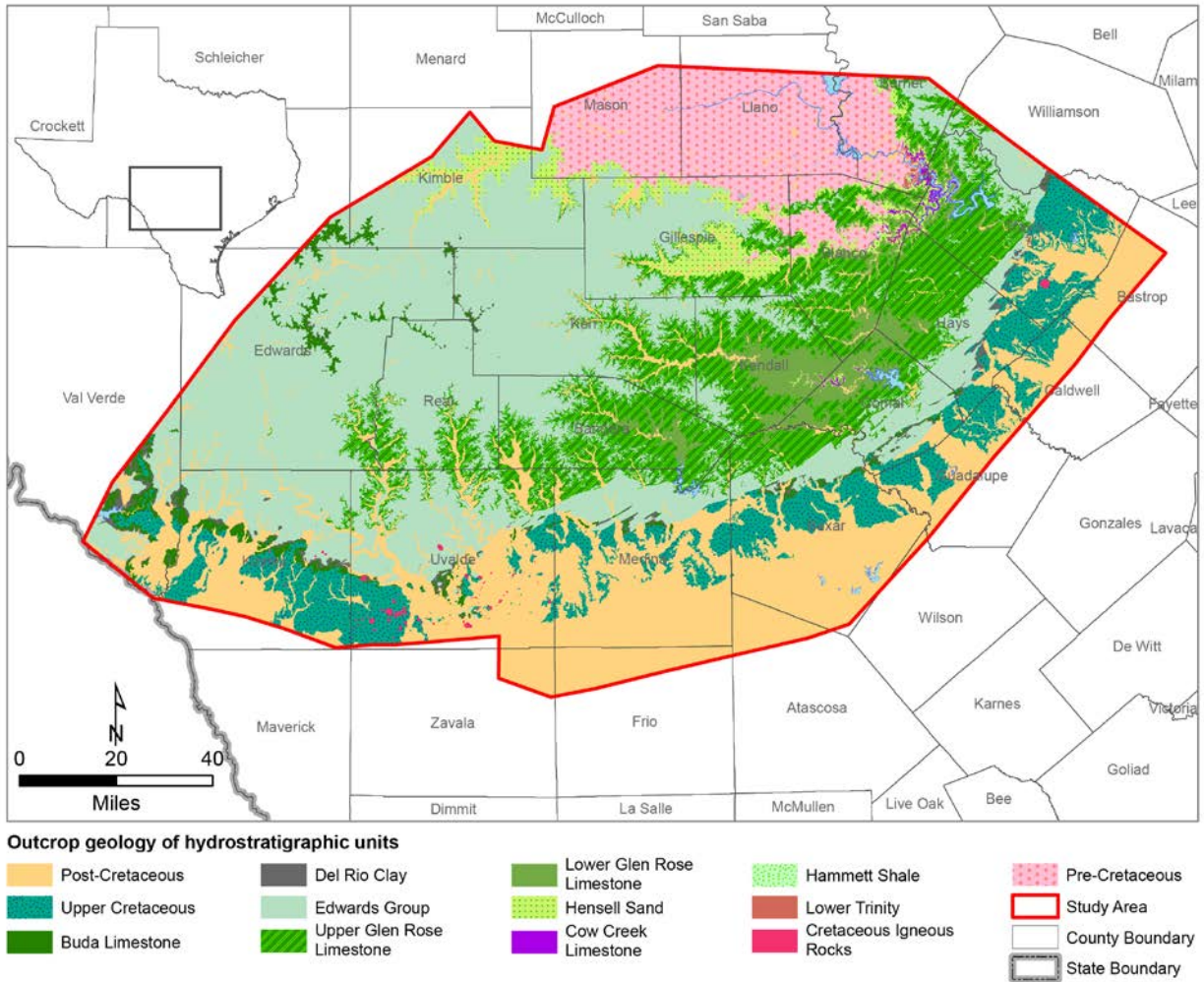

Figure 2.2.8 Generalized surface geology within the study area.

3.0 Previous Investigations

Previous investigations related to groundwater flow/availability models, hydrogeology, and the stratigraphy and geologic framework of the Hill Country region are an integral part of updating the HCT Aquifer conceptual model. The developments from this report will be incorporated into an updated GAM developed by the TWDB. Two GAMs of the HCT Aquifer have already been developed (Mace and others, 2000; Jones and others, 2011), with similarities in spatial extent but differences in model layers, calibration periods, and additional parameter data incorporated in the most recent GAM.

The original GAM was completed by Mace and others (2000) to simulate groundwater elevations and availability through 2050, encompassing most of the Hill Country area. Parts of Bandera and Uvalde counties are excluded from this domain. This model was calibrated for 1975, 1996, and 1997 and is comprised of three layers: the Edwards Group, and the Upper and Middle Trinity aquifers. In 2011, Jones and others updated and expanded upon this GAM by using the same study area and model boundary, but including the Lower Trinity Aquifer as a fourth layer. Additionally, the model was calibrated for 1980-1997 using annual stress periods; Mace and others (2000) calibrated the model using a summation of monthly stress periods for 1975 steady-state conditions and 1996 and 1997 transient conditions. The most recent GAM generally performed better than the original (Chowdhury and others, 2009) due to the extended calibration period and additional recharge data, which included gain-loss, precipitation and infiltration distribution data, and recharge through structural controls from the Balcones Fault Zone. However, the 2000 and 2011 models did not cover the entire Hill Country portion of the Trinity Aquifer, excluding parts of the aquifer in parts of Blanco, Burnet, Gillespie, Travis counties in the north and parts of Bandera, Real, and Uvalde counties in the west and did not include the confined parts of the aquifer. As such, the updated conceptual framework in this report incorporates an extended area west-east from Val Verde County to Williamson County to include all of GMA 9. Additionally, it includes the down-dip/confined portions of the Trinity Aquifer to assess inter-formational flow with the Edwards (Balcones Fault Zone) Aquifer and the effects of potential brackish groundwater production.

Although the HCT Aquifer is the focus of this report, this evaluation cannot be fully engaged without recognizing the hydraulic relationship with the Edwards (Balcones Fault Zone) Aquifer (Small, 1986; Ridgeway and Petrini, 1991; LBG-Guyton and Associates and NRS Consulting Engineers, 1995; Smith and Hunt, 2009; Fratesi and others, 2015). Hydraulic testing using nested wells conducted by the Barton Springs Edwards Aquifer Conservation District provides insight on the hydraulic properties and the hydraulic relationship among the sub-units of the Edwards and Trinity aquifers (Hunt and others, 2010, 2015; 2016).

Several studies investigating the hydrogeology of the HCT Aquifer (expressed in terms of formation and geographical location) include: aquifers of Texas (Guyton and Rose, 1945; George and others, 2011); Trinity Aquifer (Lang, 1953; Wierman and others, 2010); Cretaceous aquifers (Nordstrom, 1982); Glen Rose Formation (Hammond, 1984); Antlers and Travis Peak formations (Nordstrom, 1987); central Texas (Klemm and others, 1975; Baker and others, 1990a); north-central Texas (Baker and others, 1990b; Langley, 1999); Bandera and Kerr counties (Ashworth and others, 2001); Bell, Burnet, and Travis County (Brune and Duffin, 1983; Duffin and Musick, 1991); Blanco County (Follett, 1973); Caldwell County (Follett, 1966); Comal

Conceptual Model Report for the Hill Country Trinity Aquifer
Groundwater Availability Model

County (George and others, 1952); Edwards County (Long, 1962, 1963); Hays County (DeCook, 1963; Muller and McCoy, 1987; Broun and others, 2007); Hill County (Ashworth, 1983; Bluntzer, 1992); Kendall County (Reeves, 1967); Kerr County (Reeves, 1969); Real County (Long, 1958); Travis County (George and others, 1941); Cypress Creek/Jacob's Well (Broun and others, 2008a,b); Dripping Springs (Muller, 1990); Seco Creek (Brown, 1999). The western boundary of the study domain was the focus of a U.S. Geological Survey Regional Aquifer-System Analysis (RASA) (Kuniansky, 1989; Kuniansky and Holligan, 1994; Barker and others, 1994; Barker and Ardis, 1996). Although the focus of this RASA was the Edwards-Trinity (Plateau) Aquifer, information gained during these studies was useful in developing the hydrogeological framework of the western boundary of the study domain.

The basis of developing the hydrostratigraphic framework model partly extends from the work of Fratesi and others (2015). The authors of that study created the first three-dimensional stratigraphic framework model that incorporated offset (faulted) layers in the Hill Country area. The framework model was constructed to support a refined conceptual and numerical model of the San Antonio segment of the Edwards (Balcones Fault Zone) Aquifer. The domain of the model is the first to incorporate all three zones of the Edwards (Balcones Fault Zone) Aquifer, which inherently encompasses the extent of HCT Aquifer. In doing so, the Glen Rose Limestone of the HCT Aquifer was constructed as a part of this finite element model to account for the hydraulic communication between the Edwards and Trinity aquifers, and thus established the spatial extent and top surface elevation of the Glen Rose within the model domain. Moreover, Table 2.2.1 lists the numerous studies that were additionally used on this project to provide geologic and hydrogeologic context for construction of a hydrostratigraphic framework model.

4.0 Hydrologic Setting

The Hydrologic Setting Section describes the features and properties of the study area that influence groundwater flow. These features and properties include the hydrostratigraphy, hydrostratigraphic framework, water elevations and regional groundwater flow, recharge, surface-water bodies, hydraulic properties, discharge, and water quality.

4.1 Hydrostratigraphy and Hydrostratigraphic Framework

The Edwards and Trinity aquifers are the primary water source that supplies water for agriculture, industry, municipal, and recreation throughout central and south Texas (Sharp and Banner, 1997; Hovorka and others, 1998; Johnson and others, 2002a). Both aquifers are complex karst-, limestone-, and sand-aquifer systems that have permeability architectures that include a combination of host-rock permeability, fractures and fault zones, and dissolution features. Although the strata that make up the Edwards (Balcones Fault Zone) Aquifer (Figure 2.1.1) are younger and stratigraphically overlie the strata that comprise the Trinity Aquifer, displacement along faults of the Balcones Fault Zone has placed the Edwards (Balcones Fault Zone) Aquifer laterally against (juxtaposed) the Trinity Aquifer. The location and amount of fault juxtaposition vary by location, geometry, and displacement on faults. Along faults that define the structural interface between the Edwards and Trinity aquifers, caves and some fault zones provide conduits for groundwater flow and potential pathways for interaquifer communication. The occurrence of and degree to which interaquifer communication occurs is subject to debate, and various hydrologic and geochemical studies have attempted to constrain the amount of water that the Trinity Aquifer contributes to the Edwards (Balcones Fault Zone) Aquifer (Schultz, 1992; Johnson and others, 2010a,b; Fratesi and others, 2015).

The Edwards (Balcones Fault Zone) Aquifer is a karst aquifer (Maclay and Small, 1983; Johnson and others, 2002) consisting of porous, highly-fractured lower Cretaceous limestone. Stratigraphically, the aquifer is in the Kainer and Person Formations of the Edwards Group and the overlying Georgetown Formation (Maclay and Small, 1983). The aquifer is constrained between an upper confining unit consisting of the Del Rio Clay, Buda Limestone, and Eagle Ford Formation and the underlying upper member of the Glen Rose of the Trinity Group (Clark, 2000). The Edwards (Balcones Fault Zone) Aquifer extends along the Balcones Escarpment from Bell County in the north and east, curving southwestward through Williamson, Travis, Hays, Comal, and Bexar, then westward through Medina, Uvalde, and Kinney Counties (TNRIS, 1997; Zahm and others, 1998; Hayes, 2000).

The Trinity Aquifer consists of three parts: (i) the upper part consists of the upper member of the Glen Rose Formation, (ii) the middle part consists of the lower member of the Glen Rose Formation and the Cow Creek Limestone Member, which are separated by the Hensell Sand or Bexar Shale Member, and (iii) the lower part consists of the Hosston Formation and overlying Sligo Formation and is separated from the Cow Creek Limestone Member by the intervening Hammett Shale (Mace and others, 2000) (Figure 2.2.1). The Trinity Aquifer extends across a large portion of the Texas Hill Country to the north and west of the main faults of the Balcones

Fault Zone (Mace and others, 2000). In addition, the Trinity Aquifer extends beneath the Edwards (Balcones Fault Zone) Aquifer.

The northwest part of the study domain contains the Edwards-Trinity (Plateau) Aquifer (Figure 2.0.9). The aquifer units are composed predominantly of limestone and dolomite of the Edwards Group and sands of the Trinity Group (Mace, 2011). The division between the Edwards, Trinity, and Edwards-Trinity (Plateau) aquifers are based on regional contrast in hydraulic conductivity that determines the relative capacity within the different units across large areas of this region (Barker and Ardis, 1996). For discussion on revision to the aquifer boundaries, refer to Section 5.0 of this report.

4.1.1 Hydrostratigraphic characterization

The two main lithologies that characterize the water-bearing units within the HCT Aquifer domain are Cretaceous-age limestone and sand/sandstone. The non-water-bearing units (confining units) are dominated by clay and shale. The main challenge in characterizing the hydrostratigraphy in this region is to accurately characterize the lithologic variations across such a challenging depositional, structural geologic, and erosional environment, specifically where the (i) lithology transitions from sand (aquifer) or limestone (aquifer) to silt or shale (confining unit), or from sand (aquifer) to limestone (aquifer), (ii) where faults offset and juxtapose different hydrologic units against each other (e.g., when sand and limestone are juxtaposed, when sand/limestone and clay/silt are juxtaposed), and (iii) when units are eroded or truncated across the study area. For this study, we collected 4,529 stratigraphic formation picks for twelve hydrostratigraphic units. We correlated these stratigraphic units across the domain using geophysical logs (spontaneous potential [SP], natural gamma, and resistivity) and stratigraphic picks and unit thickness information from literature for 632 wells (Figure 4.1.1). We collected (from literature) or interpreted (from logs) stratigraphic tops for the Buda Limestone, Del Rio Clay, Georgetown Formation, Edwards Group, the upper member of the Glen Rose Formation, the lower member of the Glen Rose Formation, Hensell Formation, Cow Creek Formation, Hammett Formation, Sligo Formation, Hosston Formation, and Pre-Cretaceous undifferentiated units (top only). In addition, we interpreted lithology (sand, limestone, and shale thicknesses) throughout the Trinity Aquifer units from 10 representative wells (Figure 4.1.1) using natural gamma, SP, and resistivity log data (See LAS data files in the database delivery).

4.1.2 Fault Model

Hovorka and others (1998) produced a fault map that was used to model flow in the Edwards and Trinity aquifers. We utilized the Hovorka and others (1998) fault map for this project. The Balcones Fault Zone model for this project contains 36 faults that strike between N40° – 70°E with an average dip of 70° to the southeast and a few to the northwest (Figure 4.1.2). This fault distribution represents a small subset of the total number of faults that exist within the study area, however, the faults represented here have the largest displacements and form the largest fault blocks in the study area. According to Hovorka and others (1998), fault throws (vertical component of displacement) on these faults range from 100 to 850 feet. In the Fratesi and others (2015) study a more complex fault model was used (Figure 4.1.3). The objective of that model was to include faults that had a throw of 65 feet or greater. For that study, 130 faults met the criteria and were incorporated in the model. Figure 4.1.4 is a fault map showing an even greater distribution of faults within the study domain.

Fault distribution has primary control on the permeability architecture of stratified rocks in that it creates a difference in permeability between rock layers. If a stratigraphic sequence is not faulted, vertical inhomogeneity and anisotropy produced by layering will dominate bulk permeability. If a stratigraphic sequence is faulted, the faults exert additional controls on aquifer permeability and flow. These are (i) fault offsets alter the overall geometry of and communication between fault blocks (Allan, 1989; Maclay, 1989; Ferrill and Morris, 2001); (ii) fault zones commonly form relatively impermeable barriers to across-fault flow, form permeable pathways for along-fault flow, or form both barriers and pathways, oftentimes via relay ramps (Arnou, 1963; Caine and others, 1996; Knipe, 1997; Yielding and others, 1997; Ferrill and Morris, 2003). Fault conductivity may be influenced by the current stress field and fault activity (Finkbeiner and others, 1997; Ferrill and others, 1999); and fault-block deformation by formation of small faults and fractures leads to permeability anisotropy (Antonellini and Aydin, 1994; Mayer and Sharp, 1998; Ferrill and others, 2000).

In rock layers like those that make up the Trinity and Edwards aquifers, groundwater flow and dissolution can enhance the permeability effects of fault systems. In addition, major faults produce tilting of fault blocks and locally thin the aquifer to some fraction of its original thickness. Aquifer communication is decreased in directions perpendicular to the fault strike because of thinning and generally have increased permeability parallel to the fault zone. Smaller faults and extension fractures within fault blocks produce permeability anisotropy within fault blocks. The role of fault-block deformation in the Trinity and Edwards aquifers is variable and has a major influence on fluid flow. When performing groundwater simulations it is important to consider how to implement the permeability anisotropy that is a result of this deformation.

Relay ramps, which are common features of normal fault systems at all scales, are the products of opposite displacement gradients on two overlapping, laterally terminating, and subparallel normal faults (Ramsay and Huber, 1987; Larsen, 1988; Peacock and Sanderson, 1991, 1994; Trudgill and Cartwright, 1994; Childs et al., 1995; Huggins et al., 1995; Ferrill et al., 1999). Relay ramps transfer displacement from one fault to the next, and can serve as unbroken groundwater flow pathways through a fault system where faults offset the aquifer or serve as flow barriers (Collins and Hovorka, 1997; Hovorka et al., 1998). Localized deformation is common within relay ramps, and may be manifest by localized fault and extension fracture development which can alter fault block permeability (Ferrill et al., 1999; Ferrill and Morris, 2001; Morris et al., 2014).

4.1.3 Hydrostratigraphic Framework Model

The stratigraphic framework model was developed to set the boundaries, define distribution of layer thicknesses, and to provide a sufficient-resolution, data- and observation-constrained stratigraphic framework to support the development of the conceptual model and a future GAM for the HCT Aquifer domain. In addition, the stratigraphic framework model was constructed with goals of producing a three-dimensional representation of the faulted aquifers and confining strata that can be used to determine and illustrate potential stratigraphic and structural controls upon recharge, groundwater flow, and transmissivity within or between the hydrostratigraphic units. The stratigraphic framework model substantially expands the previous HCT Aquifer

Conceptual Model Report for the Hill Country Trinity Aquifer Groundwater Availability Model

domain. To reduce uncertainties in future GMAs (i.e., with fewer inaccuracies and less uncertainty), it is important to have a data-constrained stratigraphic framework model.

The hydrostratigraphic model was created using currently available data, including published geologic and topographic maps, stratigraphic-horizon picks from literature and wells, and stratigraphic interpretations. We followed the approach for model construction that is summarized in Figure 4.1.5, Figure 4.1.6, and Figure 4.1.7.

The hydrostratigraphic model was structured into eleven stratigraphic layers, these include the Edwards (structured surface, Figure 4.1.8; isopach, Figure 4.1.9), the upper member of the Glen Rose Formation (structured surface, Figure 4.1.10; isopach, Figure 4.1.11), lower member of the Glen Rose Formation (structured surface, Figure 4.1.12; isopach, Figure 4.1.13), Hensell Sand (structured surface, Figure 4.1.14; isopach, Figure 4.1.15), Cow Creek Limestone (structured surface, Figure 4.1.16; isopach, Figure 4.1.17), Hammett Shale (structured surface, Figure 4.1.18; isopach, Figure 4.1.19), the Sligo Formation (structured surface, Figure 4.1.20; isopach, Figure 4.1.21), Hosston Formation (structured surface, Figure 4.1.22; isopach, Figure 4.1.23), and the Pre-Cretaceous formations (structured surface, Figure 4.1.24). Lateral changes in aquifer geometry and fault juxtaposition are illustrated in three vertical geologic cross sections extracted from the hydrostratigraphic framework model (Figure 4.1.5, Figure 4.1.6, and Figure 4.1.7). By developing a detailed hydrostratigraphic model, additional layers can be incorporated into the numerical model without having to develop a new model. As new data become available, this model can be efficiently modified in an iterative fashion to keep the hydrostratigraphic framework up-to-date for use as the basis for increasingly refined groundwater flow and availability modeling.

4.1.4 Stratigraphic Framework Model Software

Three primary software programs were used to develop the stratigraphic framework model: (i) Microsoft Excel 2010, (ii) ESRI ArcGIS 10.4, and (iii) Schlumberger Petrel 2015.1. These programs were used to organize tabulated data, assemble and analyze geographically distributed data and interpretations, and conduct three-dimensional stratigraphic framework modeling, respectively.

Microsoft Excel 2010 was used to compile well data including locations, well-head elevation (datum), stratigraphic picks, and thickness information. A spreadsheet of formation thicknesses across the model domain and a quality controlled database of well picks was compiled using this information.

ESRI ArcGIS 10.4 was used to assemble topography, geologic maps, structural data, and other geographically distributed data. These data were used as the basis for defining the model domain and constructing the stratigraphic framework model. Digital data used to create the model were georeferenced. Well picks were evaluated using published maps and point shapefiles.

Petrel is a Windows PC software package that is used primarily by the oil and gas industry and was used to construct stratigraphic framework models. This software package allows surface and subsurface data to be assimilated from multiple sources. Stratigraphic and structural geologic interpretation can then be performed using the database. This integrated software package was

Conceptual Model Report for the Hill Country Trinity Aquifer
Groundwater Availability Model

selected for this application because of its flexibility in handling data, interpretation, and model development and manipulation, which eliminates the need for multiple highly specialized tools, which would otherwise be required. Petrel has a wide range of export options that facilitate preparing data for input into models and into other software packages.

The stratigraphic framework model was developed in the custom GAM coordinate system. This system uses an Albers projection and the North American 1983 geographic coordinate system and vertical datum. Vertical positions are in feet with respect to mean sea level.

Conceptual Model Report for the Hill Country Trinity Aquifer
Groundwater Availability Model

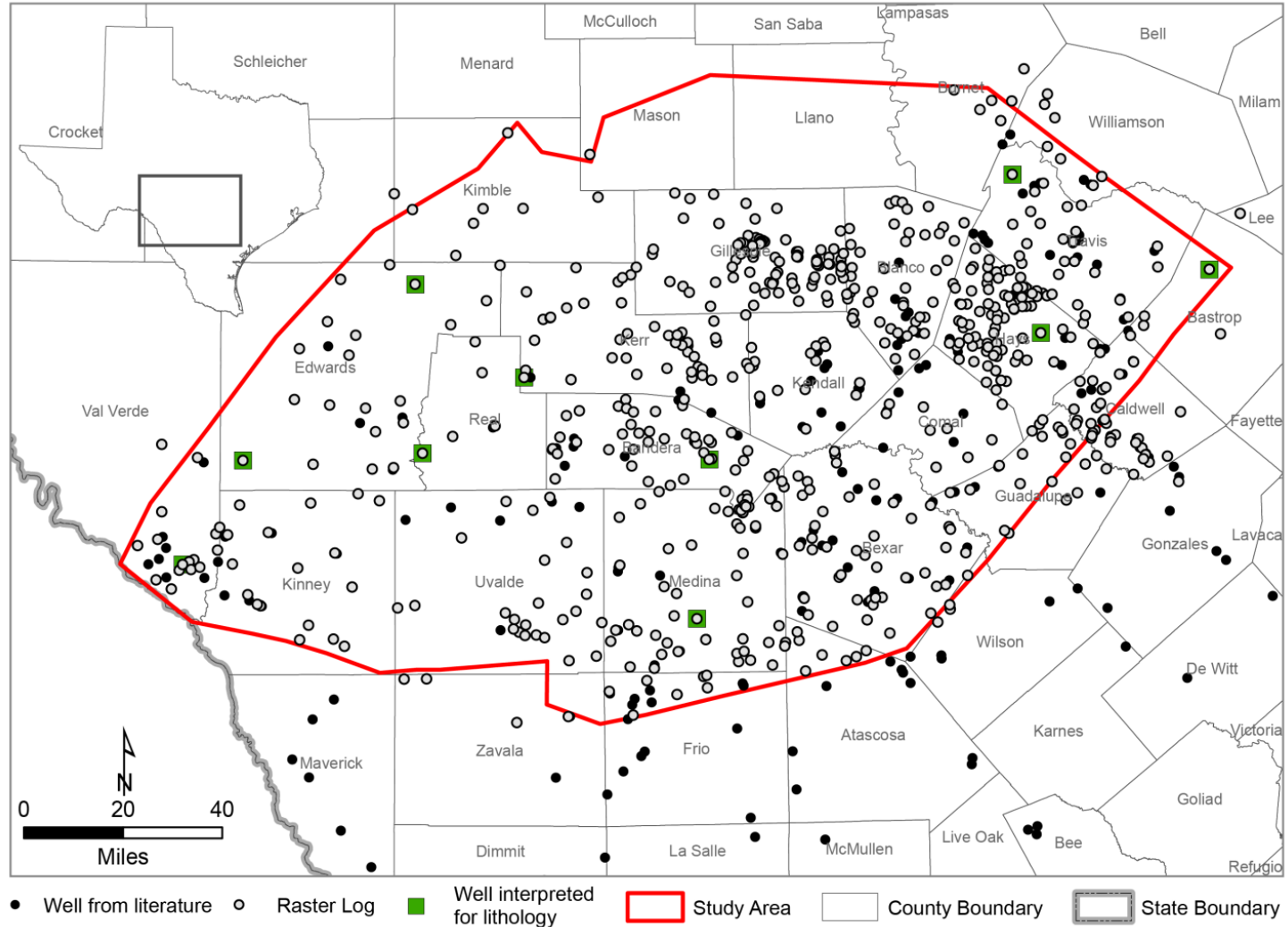

Figure 4.1.1 Wells used for hydrostratigraphic characterization.

Conceptual Model Report for the Hill Country Trinity Aquifer
Groundwater Availability Model

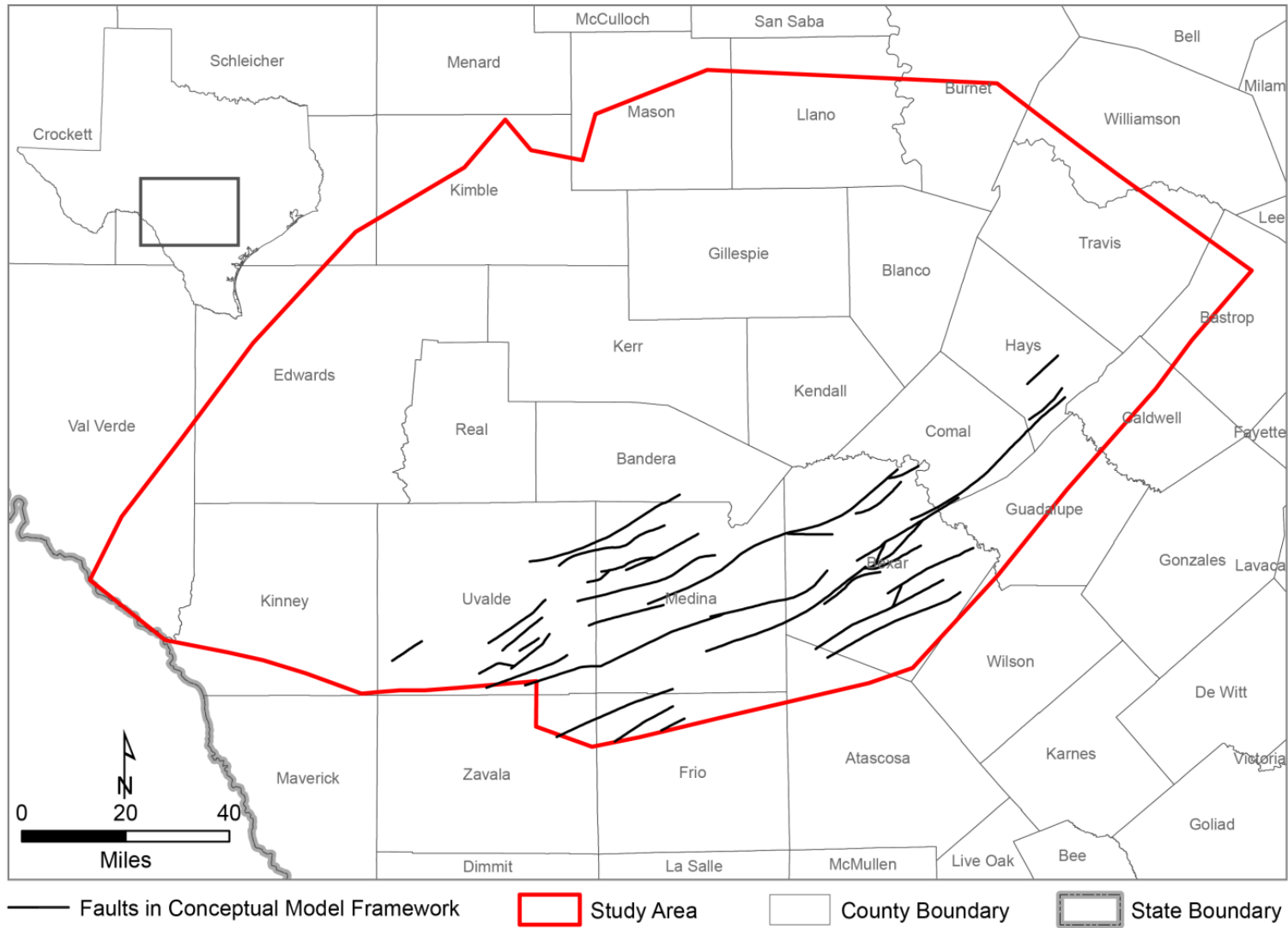

Figure 4.1.2 Fault map of faults that were modeled in this study (Hovorka and others, 1998).

Conceptual Model Report for the Hill Country Trinity Aquifer
Groundwater Availability Model

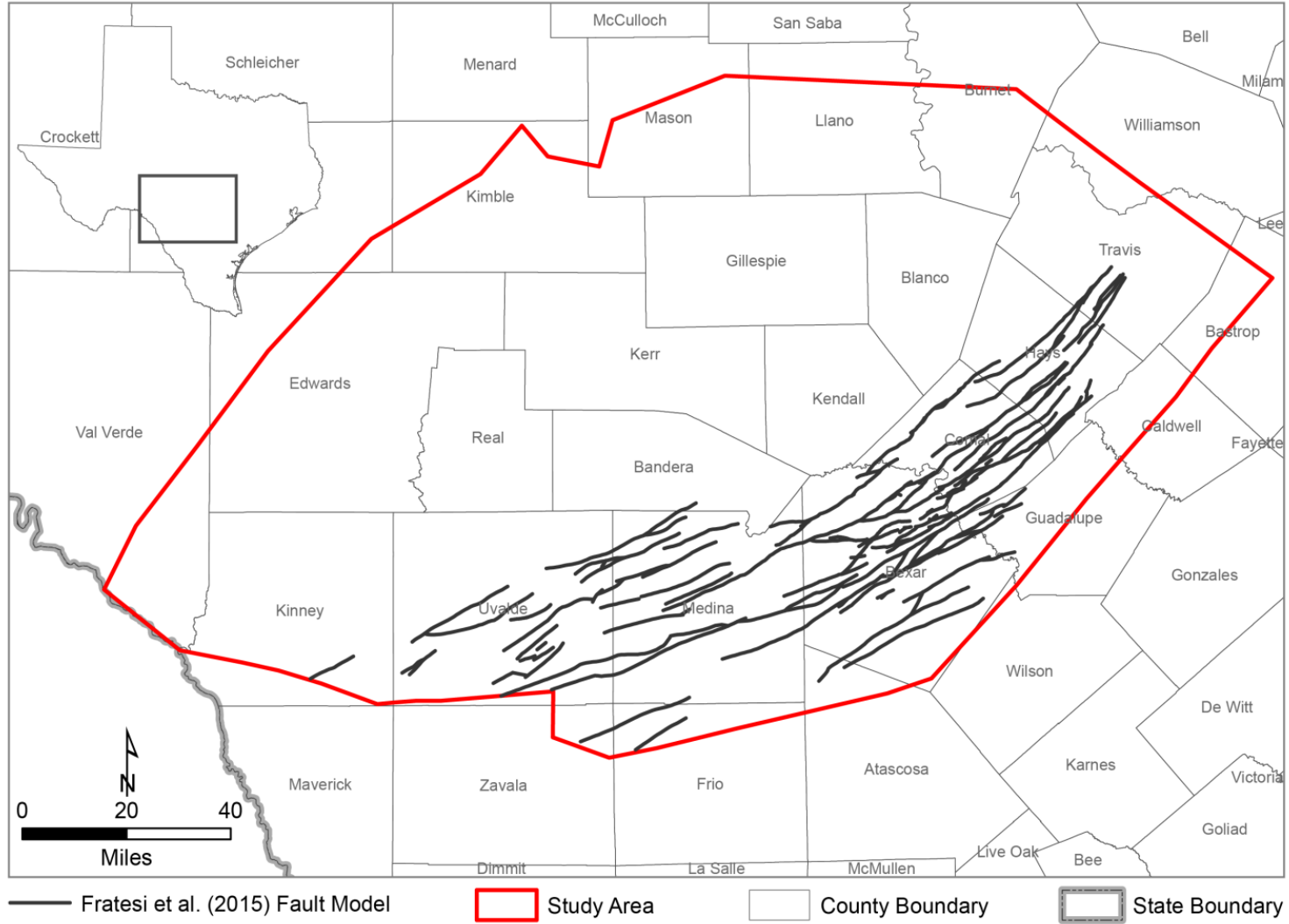

Figure 4.1.3 Fratesi and others (2015) fault model.

Conceptual Model Report for the Hill Country Trinity Aquifer
Groundwater Availability Model

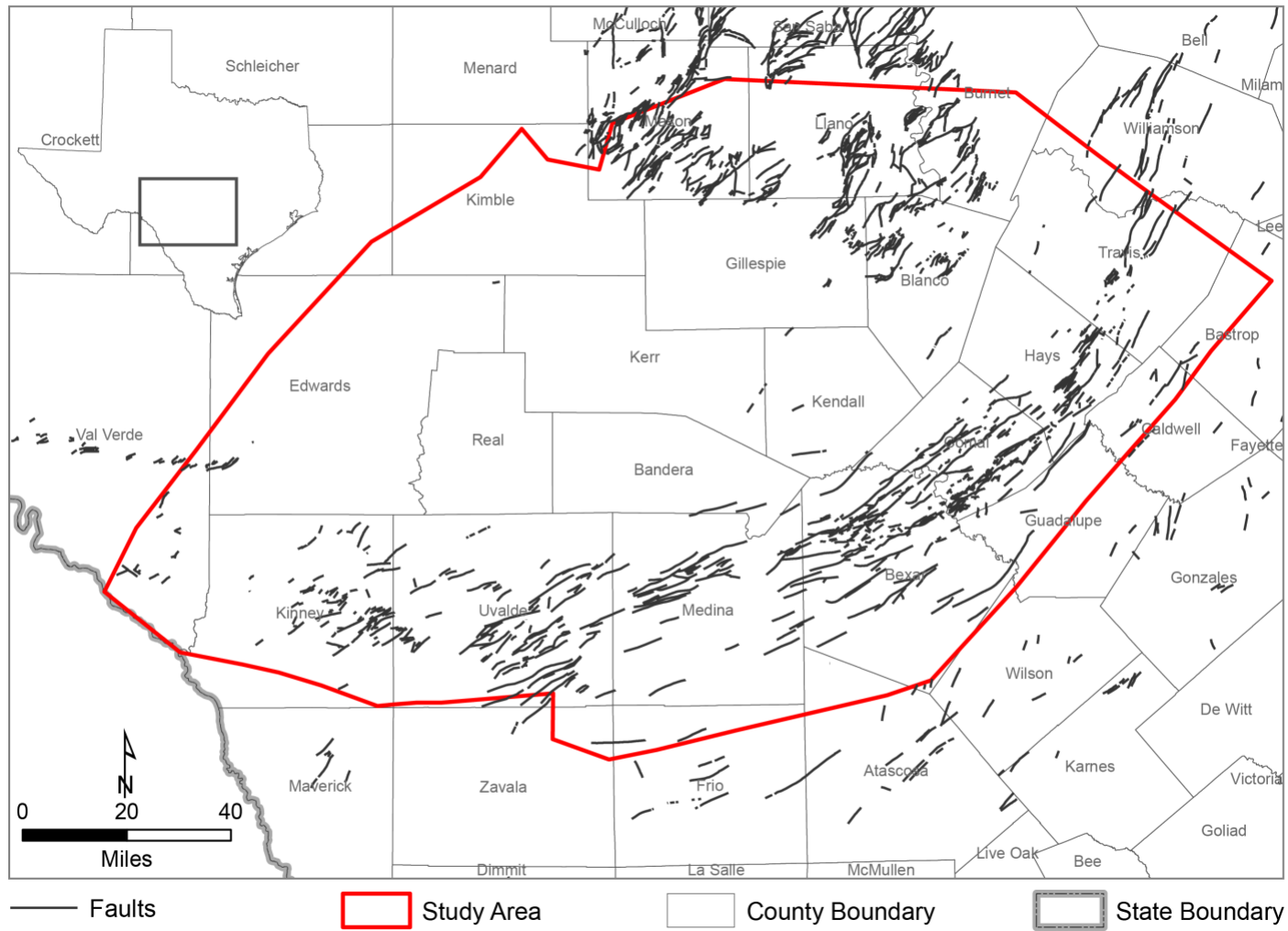

Figure 4.1.4 High resolution fault map representing faults from numerous sources (Collins and Hovorka, 1997; Barnes, 1977, 1983; Fisher, 1983; Ferrill and Morris, 2008; Ferrill and others, 2003, 2004, 2005, 2008, 2011; Fratesi and others, 2015).

Conceptual Model Report for the Hill Country Trinity Aquifer
Groundwater Availability Model

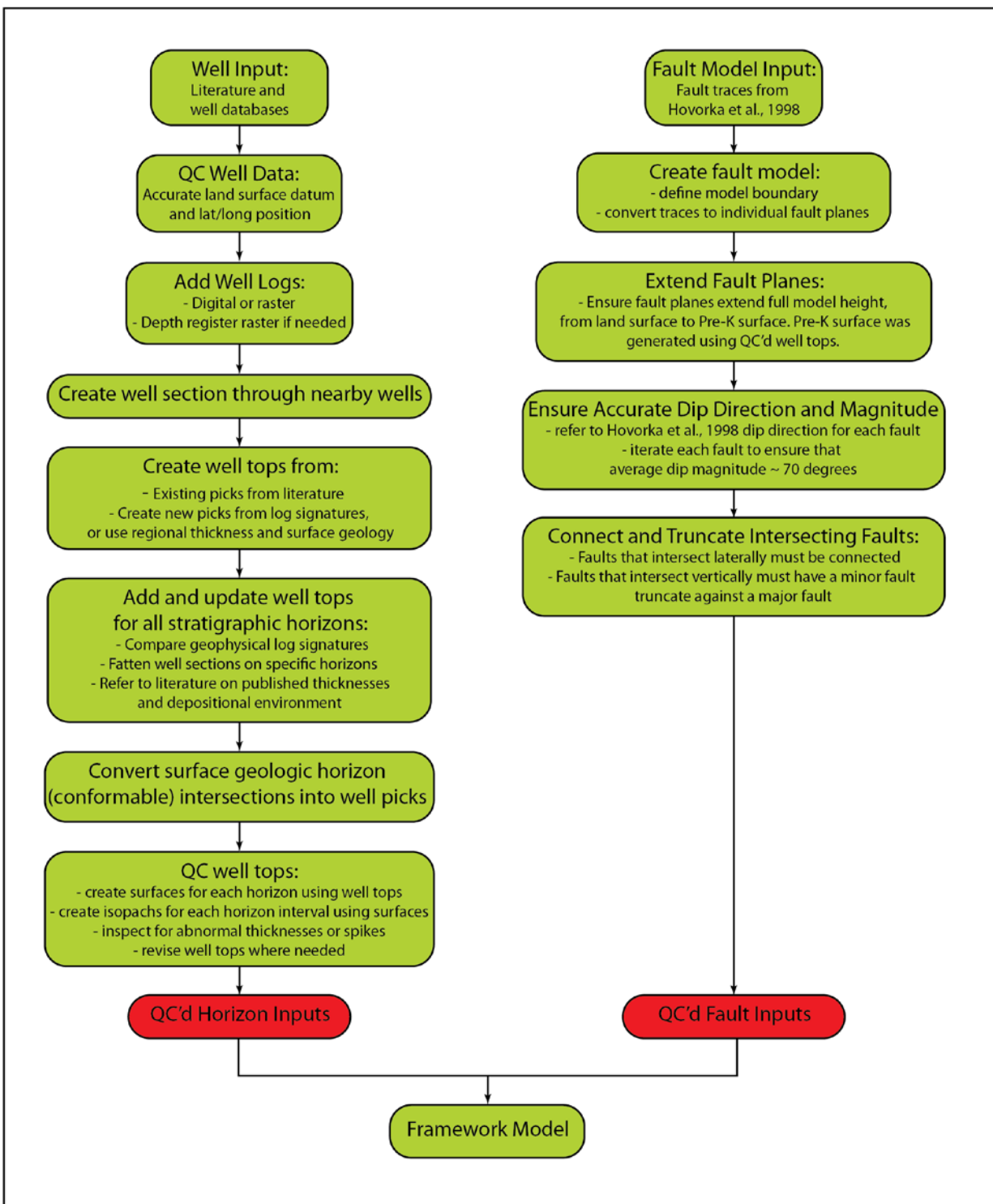

Figure 4.1.5 Flow chart for developing horizon and fault input for implementation into the hydrostratigraphic framework model.

Conceptual Model Report for the Hill Country Trinity Aquifer
Groundwater Availability Model

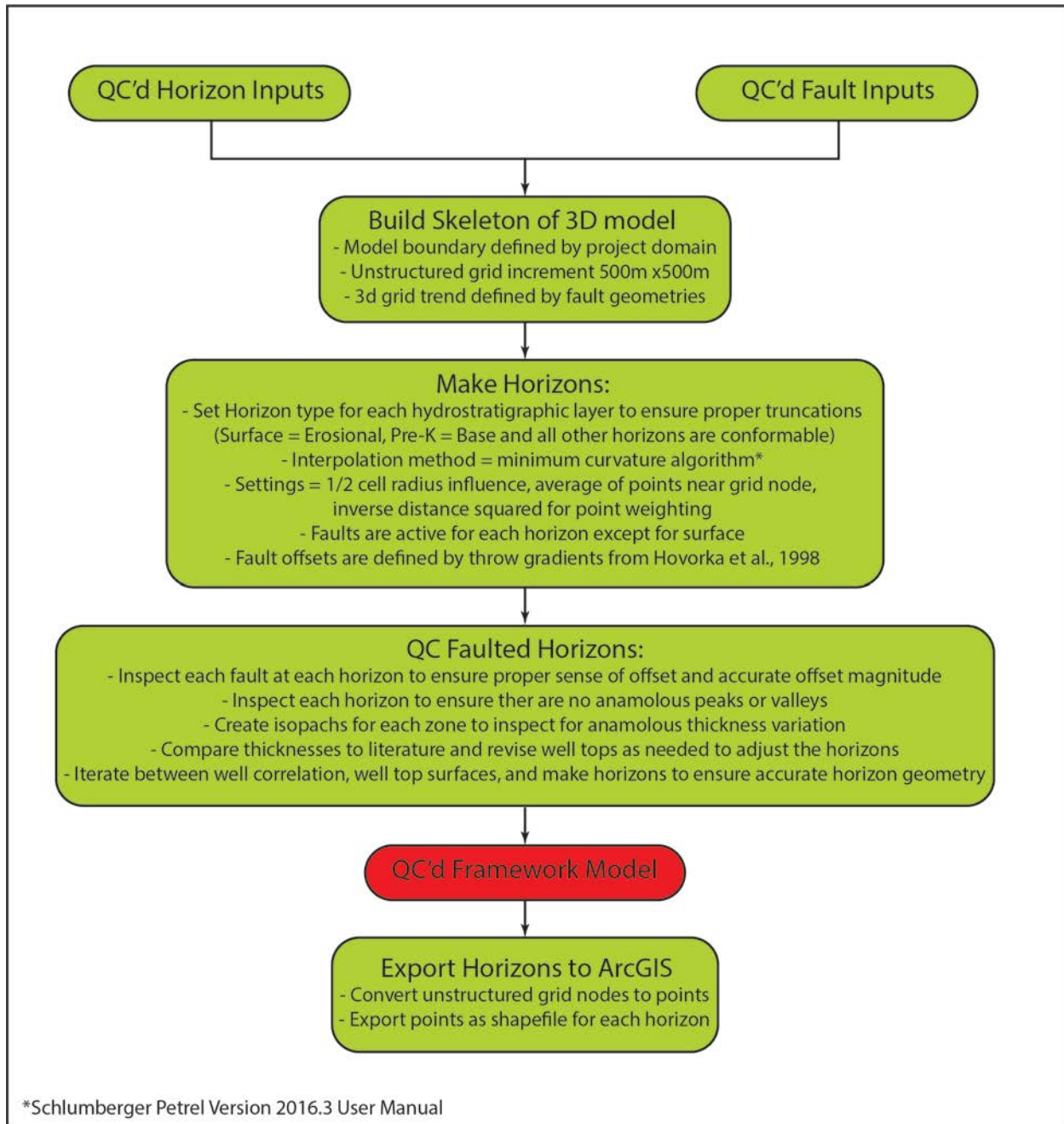

Figure 4.1.6 Flow chart for developing the hydrostratigraphic framework model.

Conceptual Model Report for the Hill Country Trinity Aquifer
Groundwater Availability Model

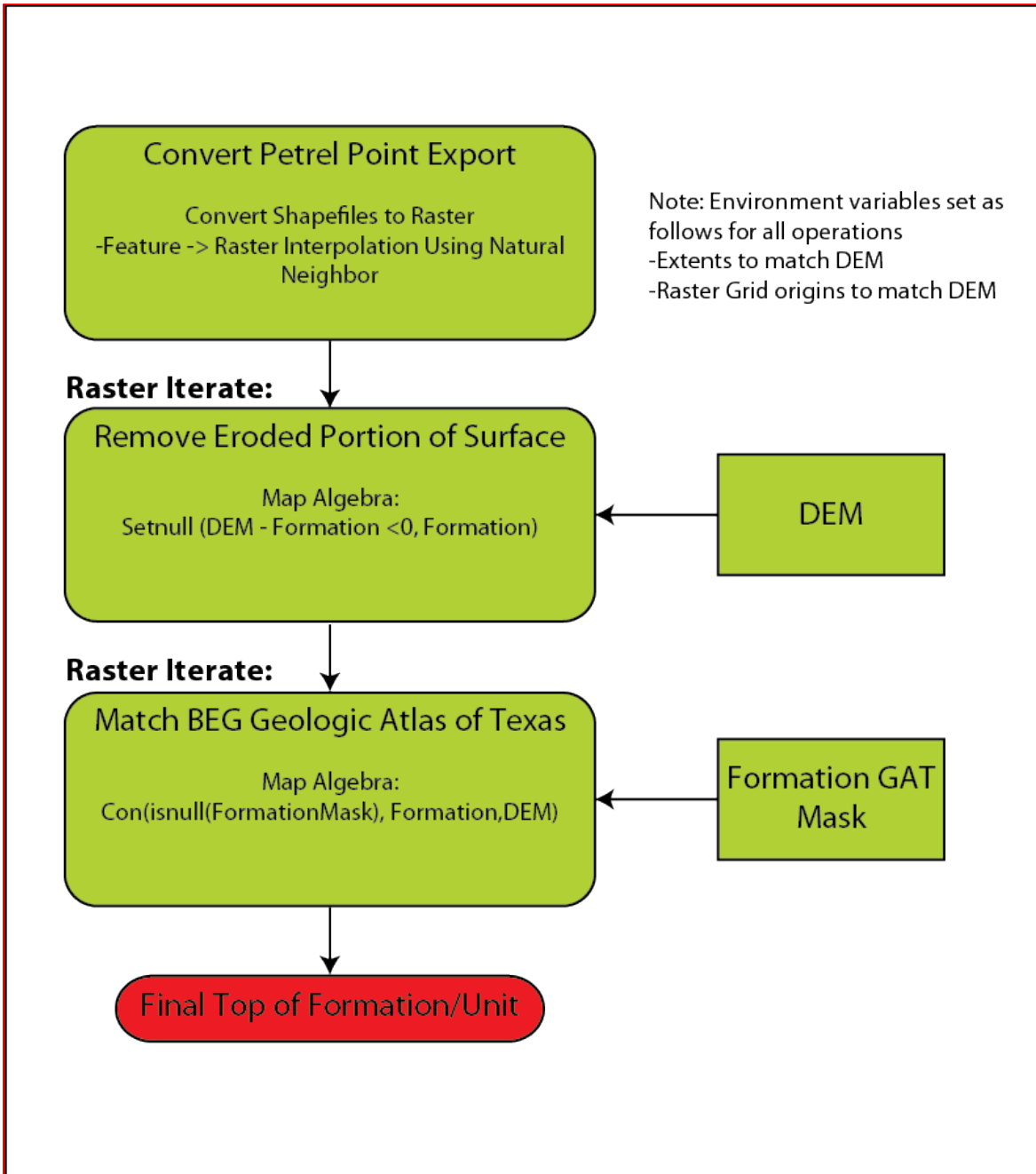

Figure 4.1.7 Flow chart for developing the finalized raster surfaces using ESRI ArcGIS modelbuilder.

Conceptual Model Report for the Hill Country Trinity Aquifer
Groundwater Availability Model

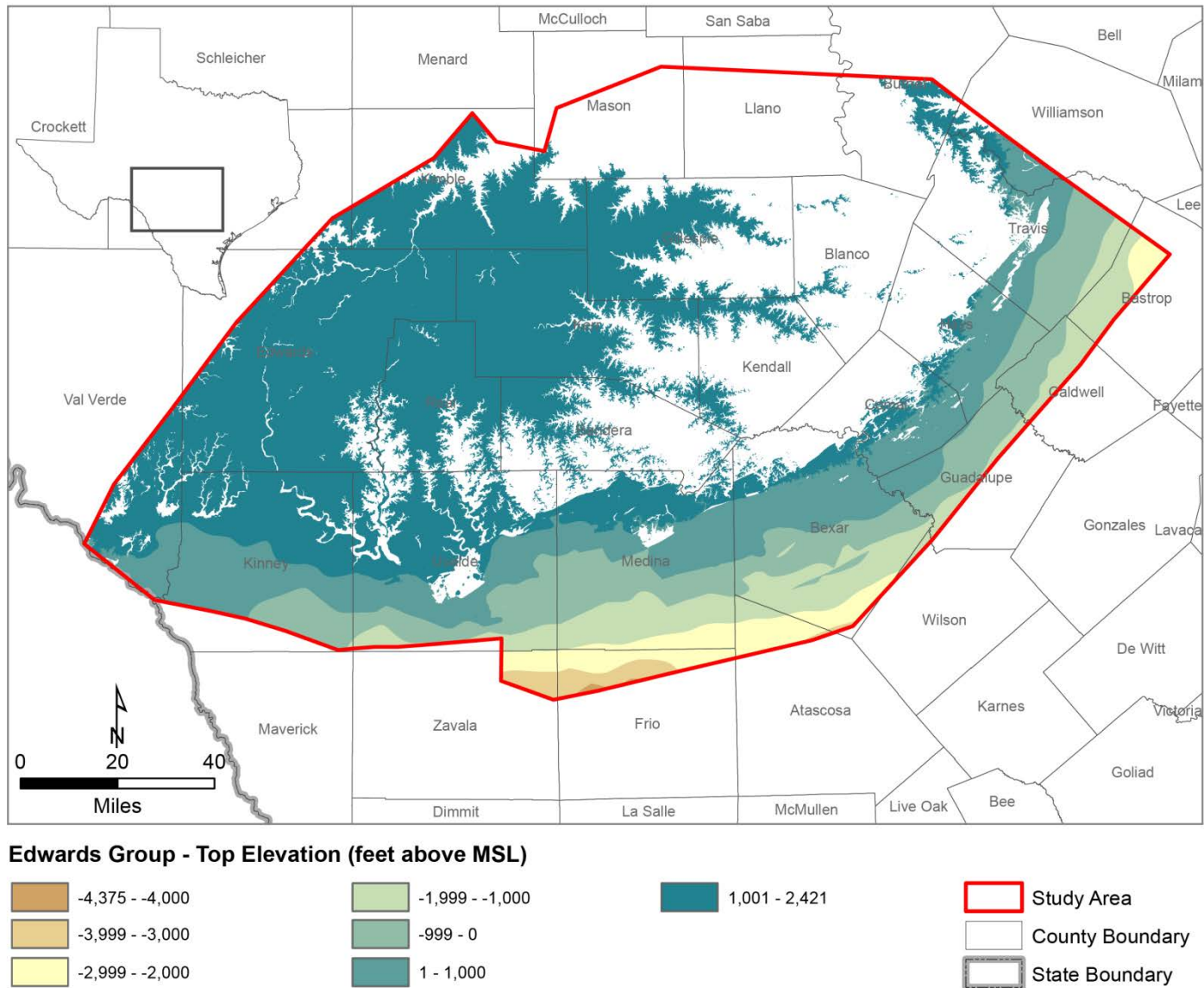

Figure 4.1.8 The elevation (in feet above mean sea level (MSL)) of the top of the Edwards Group.

Conceptual Model Report for the Hill Country Trinity Aquifer
Groundwater Availability Model

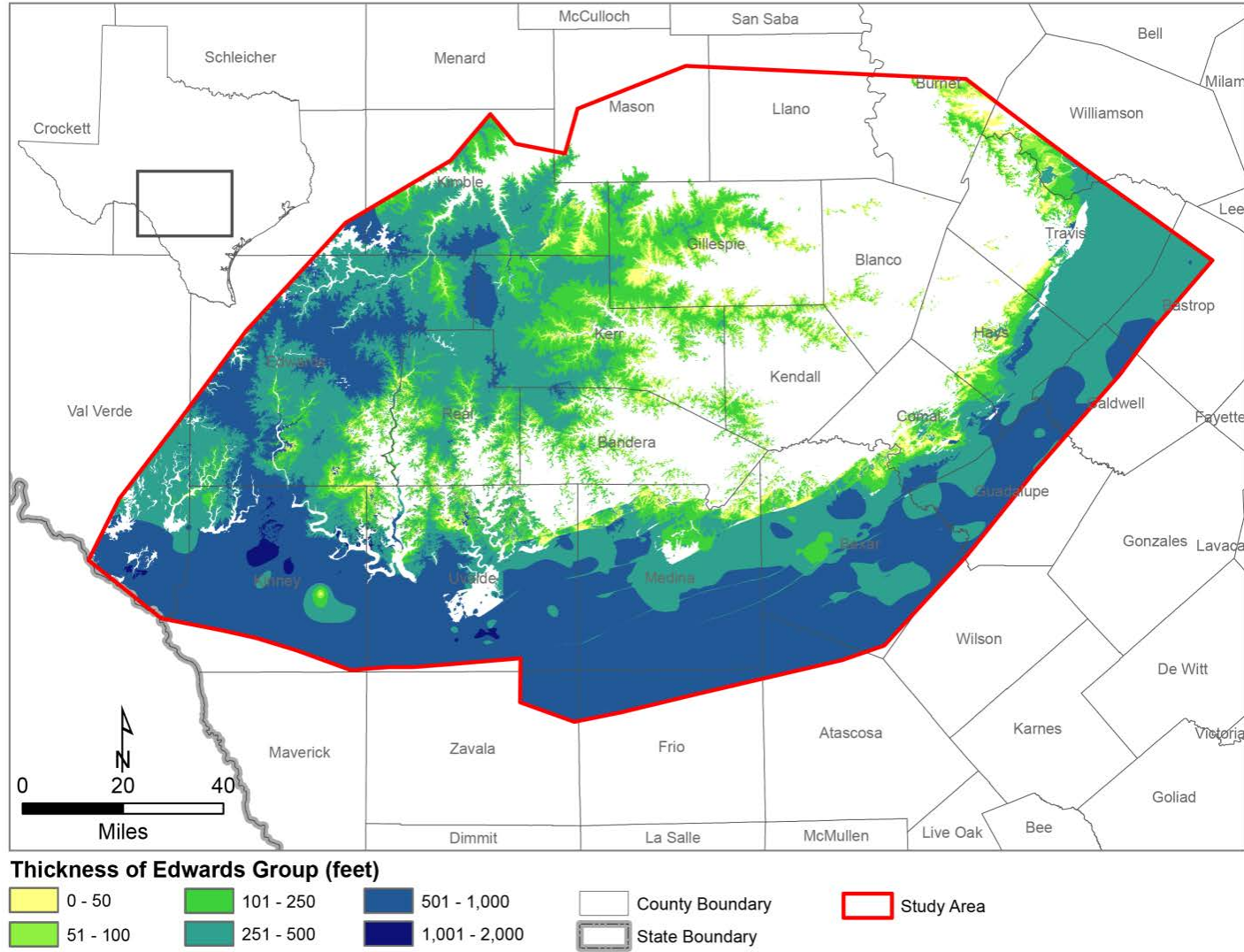

Figure 4.1.9 Thickness (in feet) of the Edwards Group.

Conceptual Model Report for the Hill Country Trinity Aquifer
Groundwater Availability Model

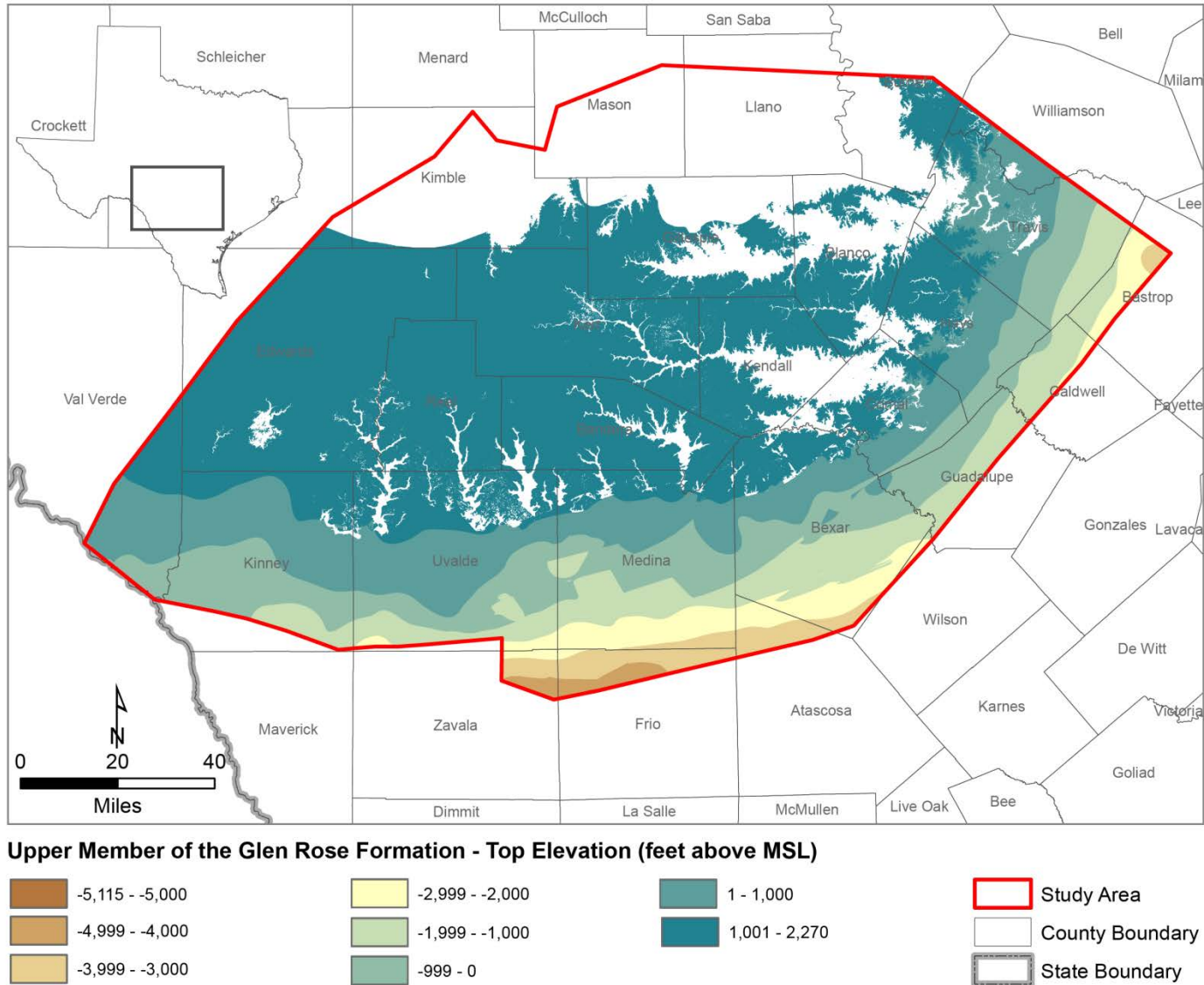

Figure 4.1.10 The elevation (in feet above mean sea level (MSL)) of the top of the upper member of the Glen Rose Formation.

Conceptual Model Report for the Hill Country Trinity Aquifer
Groundwater Availability Model

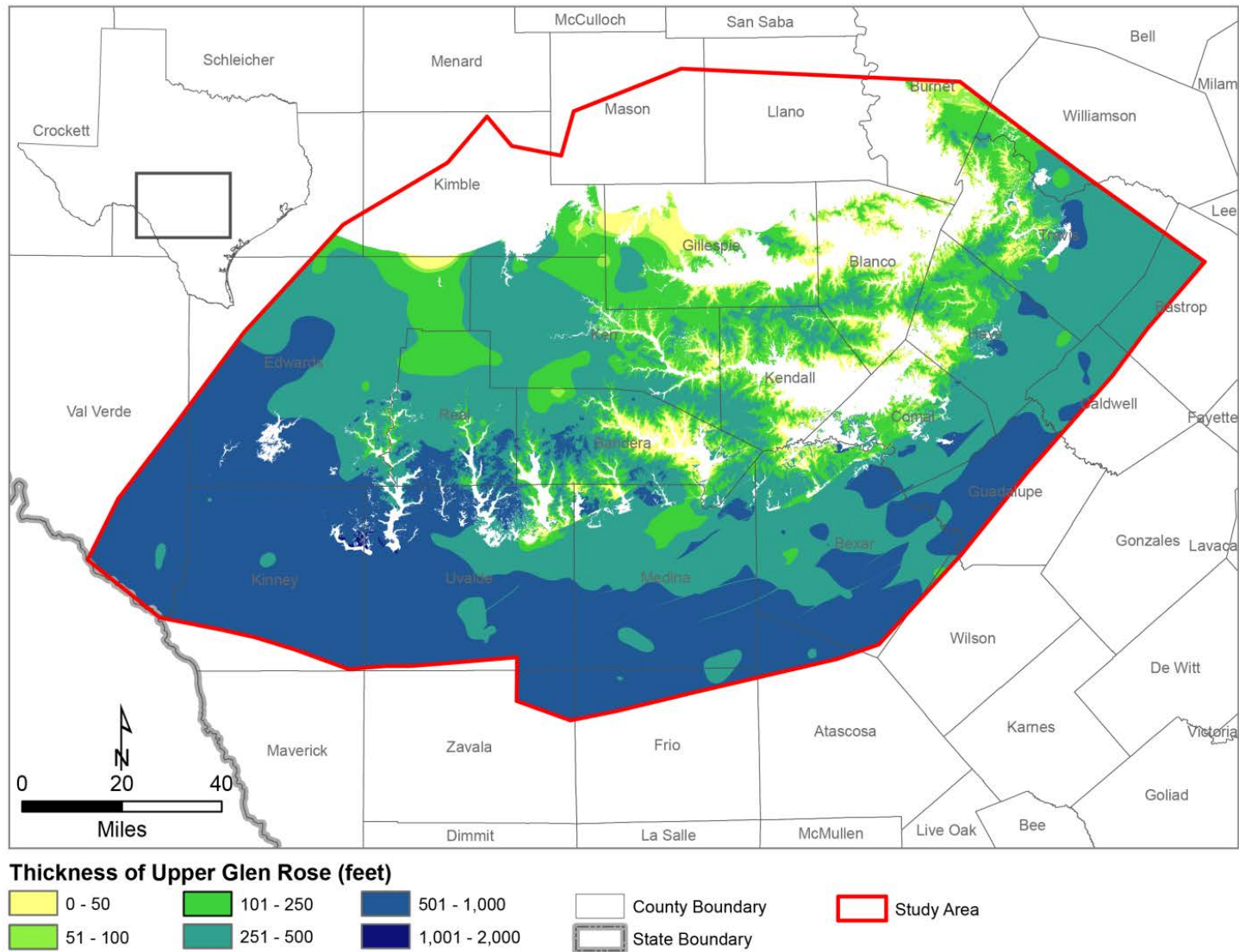

Figure 4.1.1.1 Thickness (in feet) of the upper member of the Glen Rose Formation.

Conceptual Model Report for the Hill Country Trinity Aquifer
Groundwater Availability Model

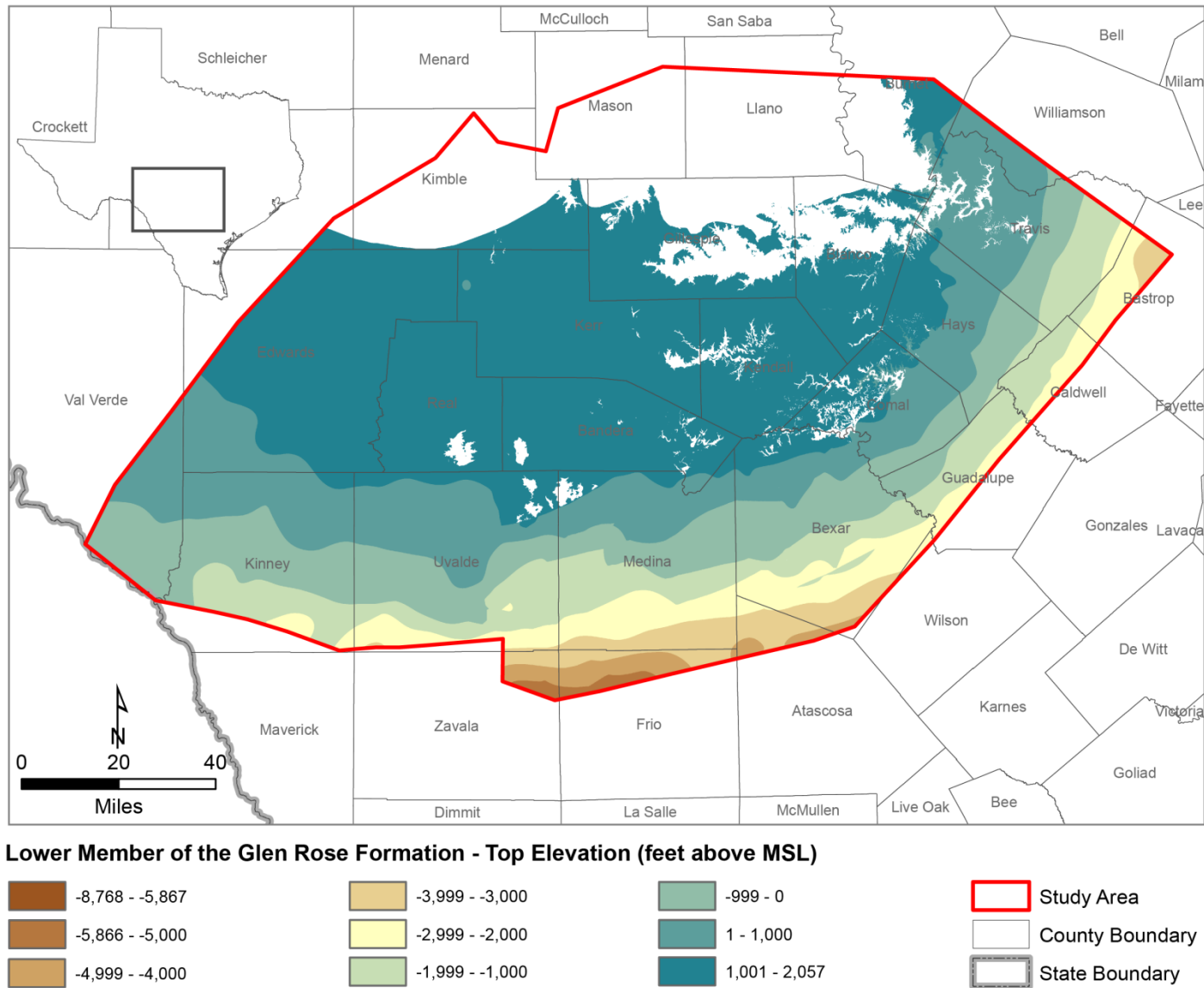

Figure 4.1.1 2 The elevation (in feet above mean sea level (MSL)) of the top of the lower member of the Glen Rose Formation.

Conceptual Model Report for the Hill Country Trinity Aquifer
Groundwater Availability Model

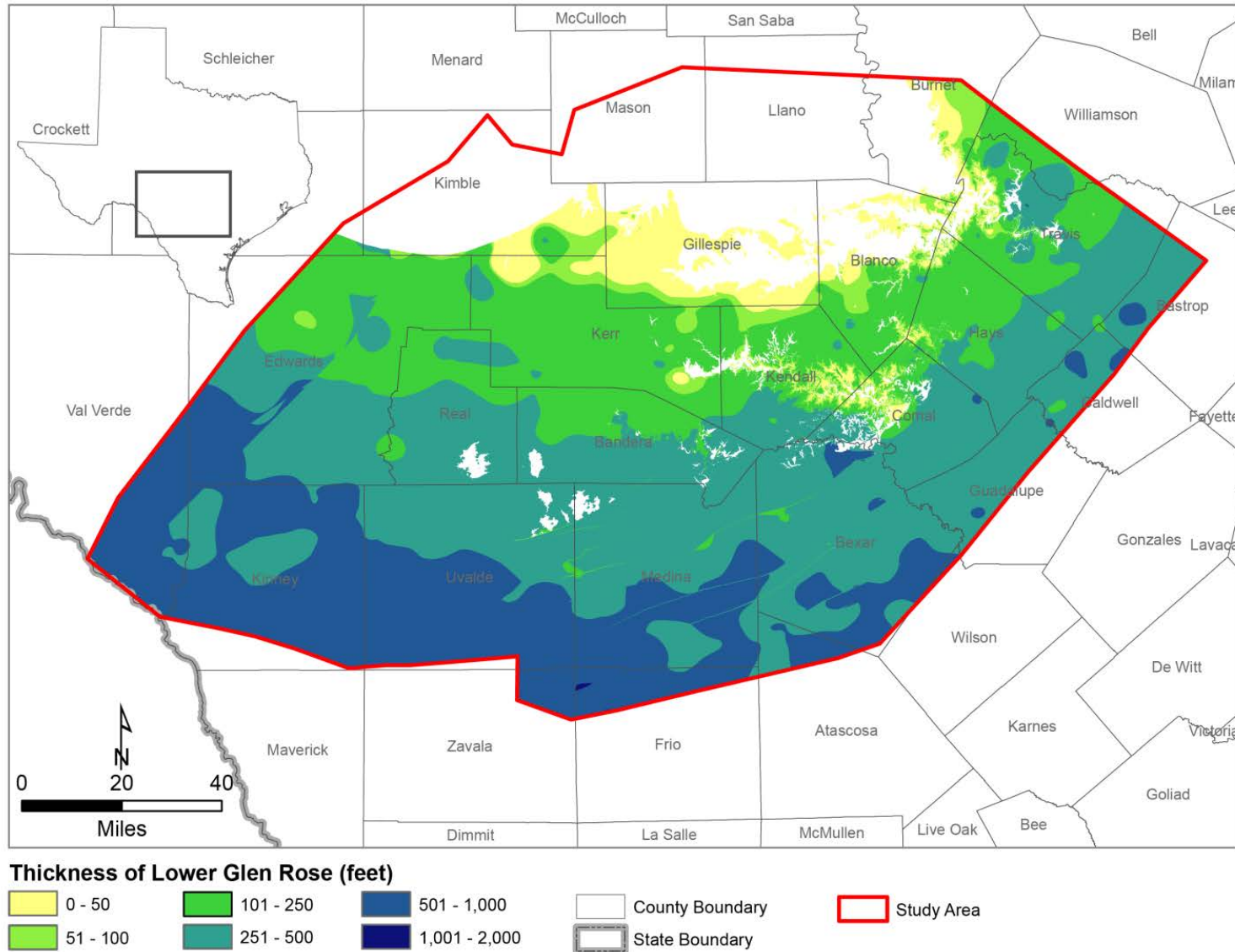

Figure 4.1.13 Thickness (in feet) of the lower member of the Glen Rose Formation.

Conceptual Model Report for the Hill Country Trinity Aquifer
Groundwater Availability Model

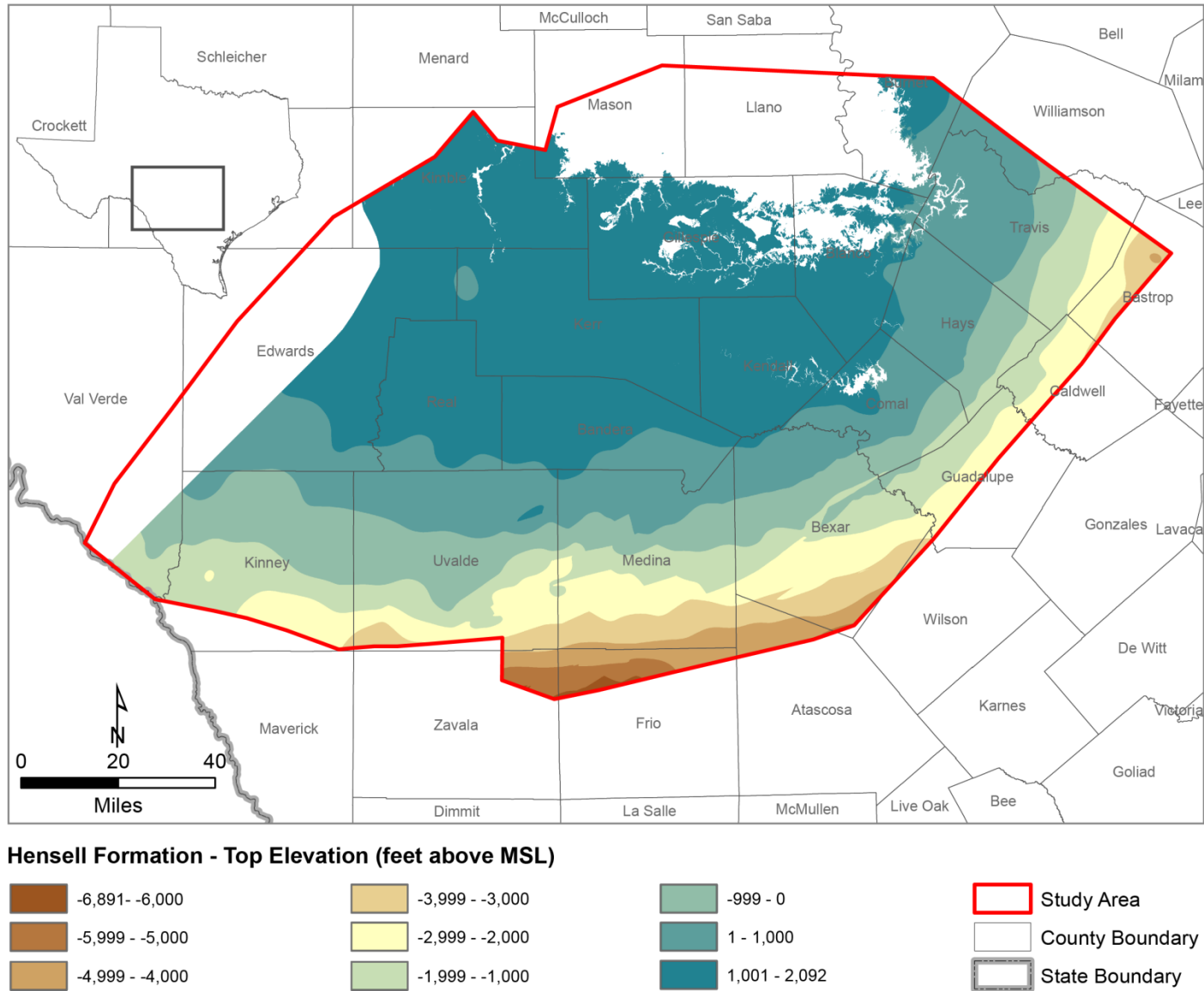

Figure 4.1.14 The elevation (in feet above mean sea level (MSL)) of the top of the Hensell Formation.

Conceptual Model Report for the Hill Country Trinity Aquifer
Groundwater Availability Model

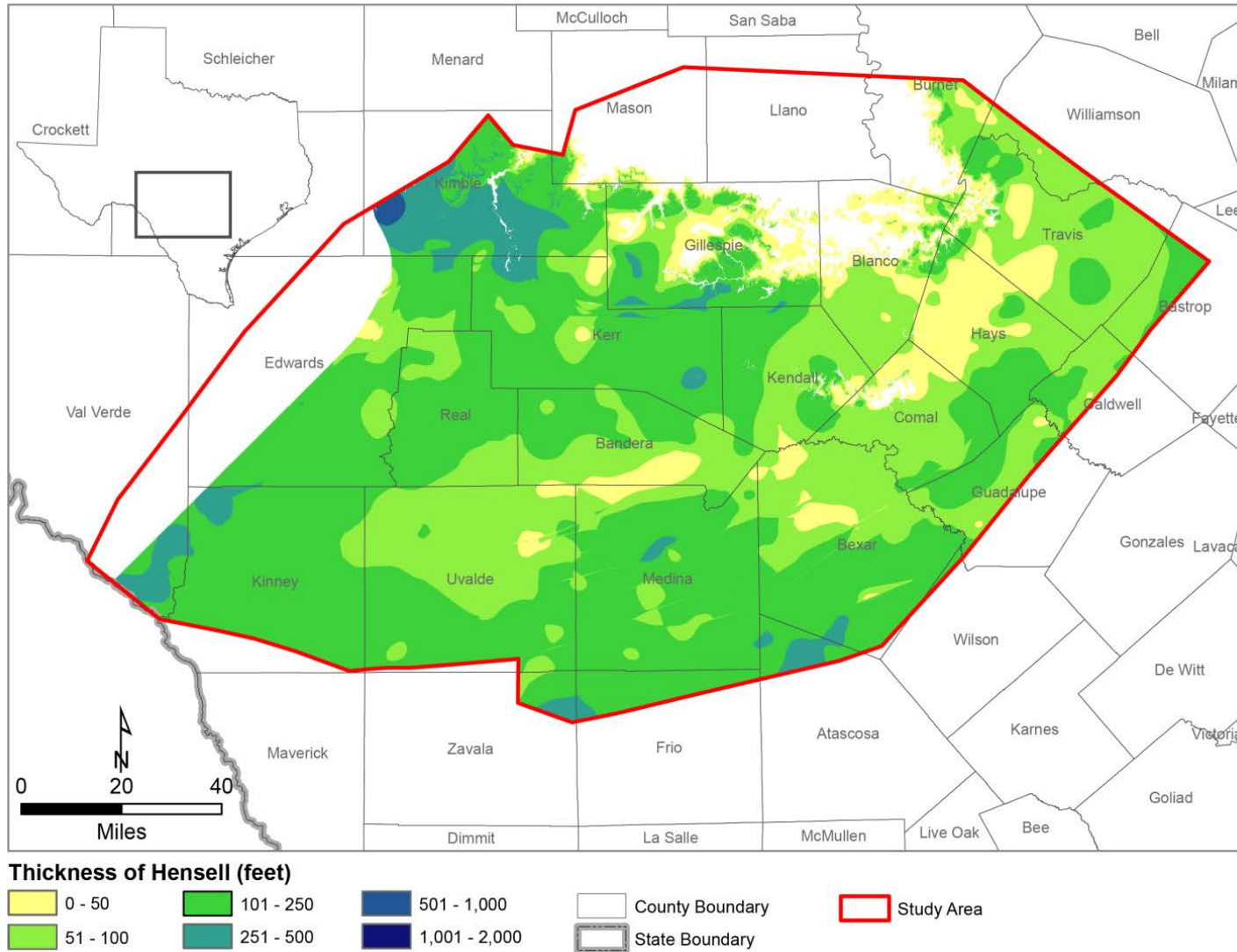

Figure 4.1.15 Thickness (in feet) of the Hensell Formation.

Conceptual Model Report for the Hill Country Trinity Aquifer
Groundwater Availability Model

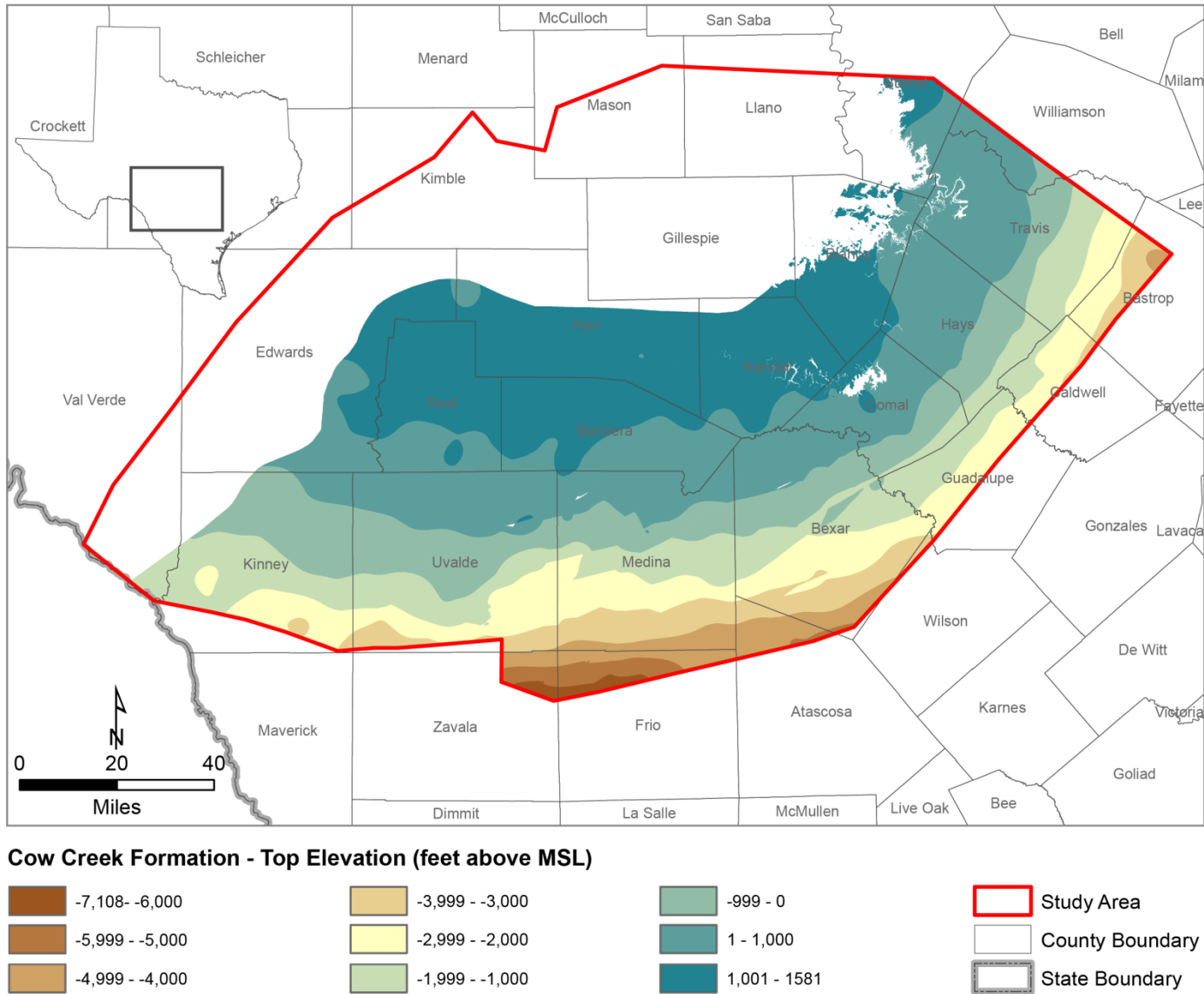

Figure 4.1.16 The elevation (in feet above mean sea level (MSL)) of the top of the Cow Creek Formation.

Conceptual Model Report for the Hill Country Trinity Aquifer
Groundwater Availability Model

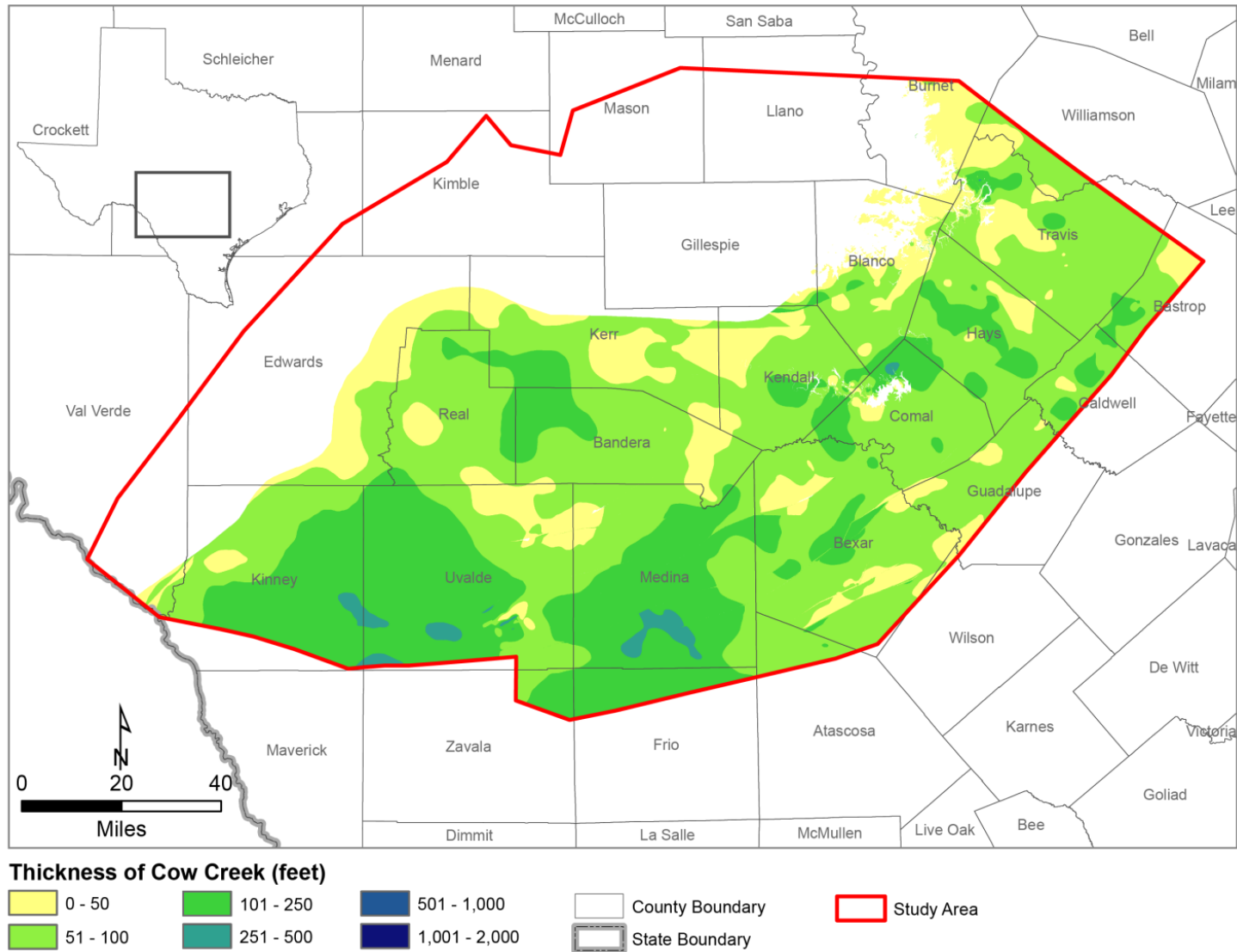

Figure 4.1.17 Thickness (in feet) of the Cow Creek Formation.

Conceptual Model Report for the Hill Country Trinity Aquifer
Groundwater Availability Model

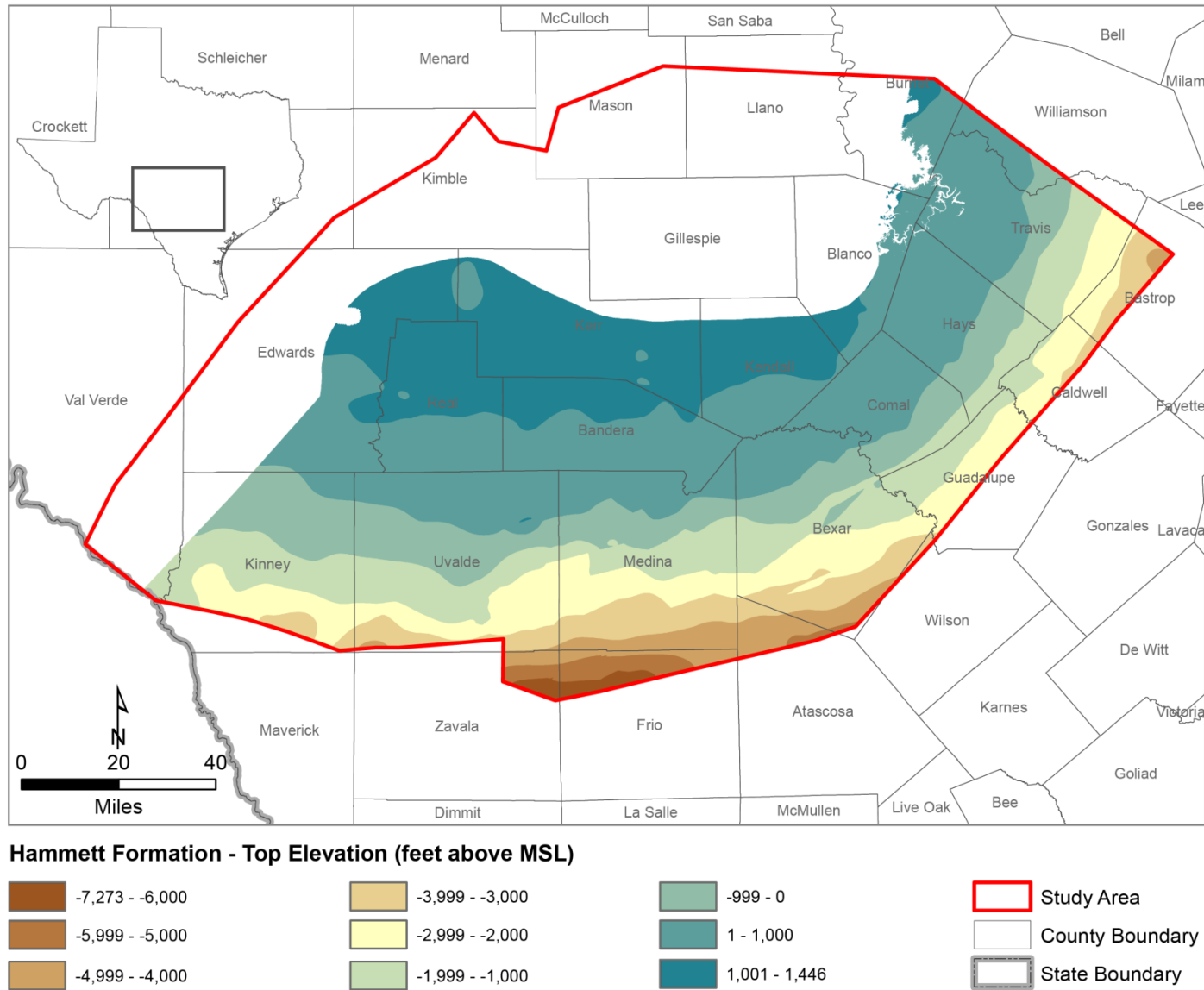

Figure 4.1.18 The elevation (in feet above mean sea level (MSL)) of the top of the Hammett.

Conceptual Model Report for the Hill Country Trinity Aquifer
Groundwater Availability Model

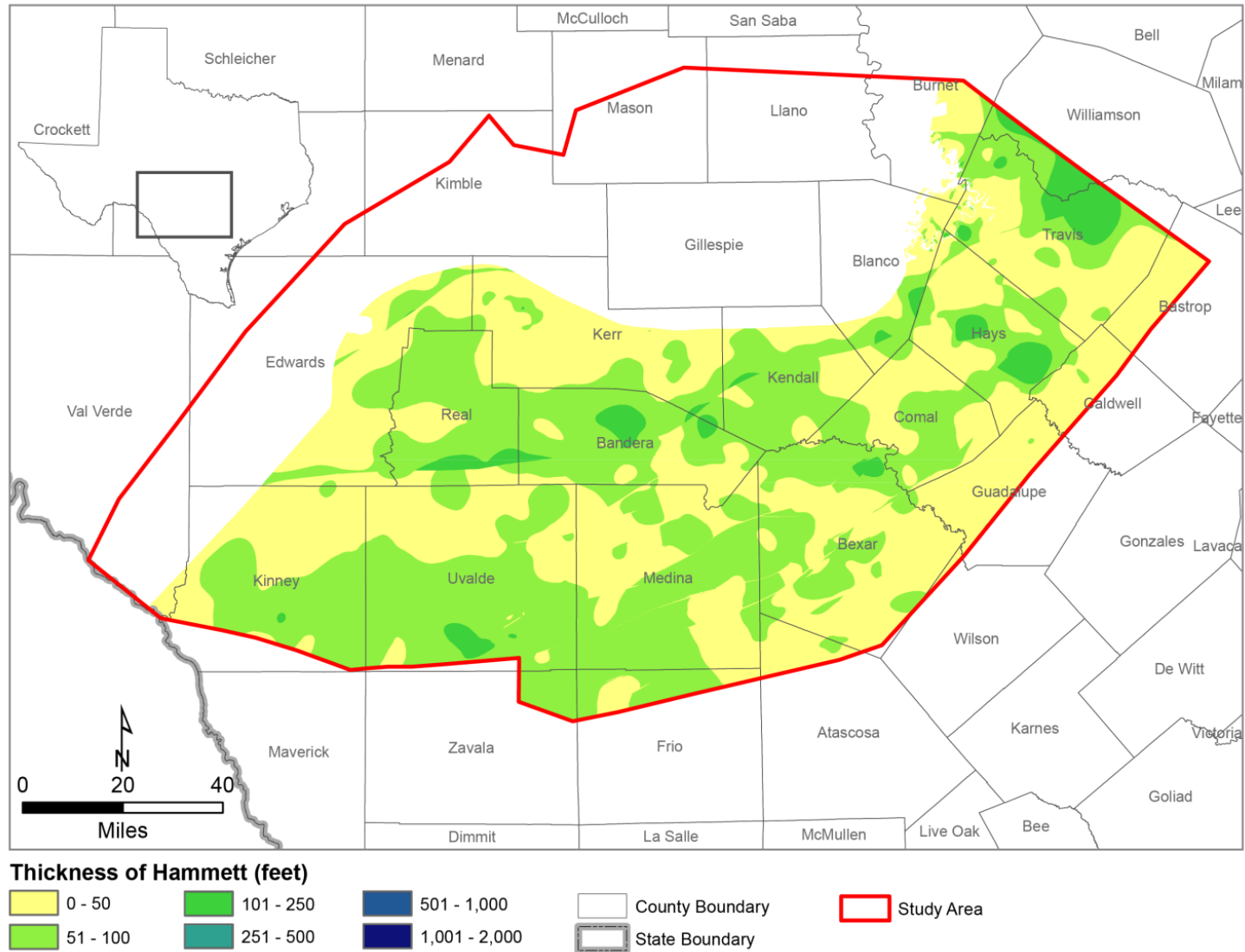

Figure 4.1.19 Thickness (in feet) of the Hammett.

Conceptual Model Report for the Hill Country Trinity Aquifer
Groundwater Availability Model

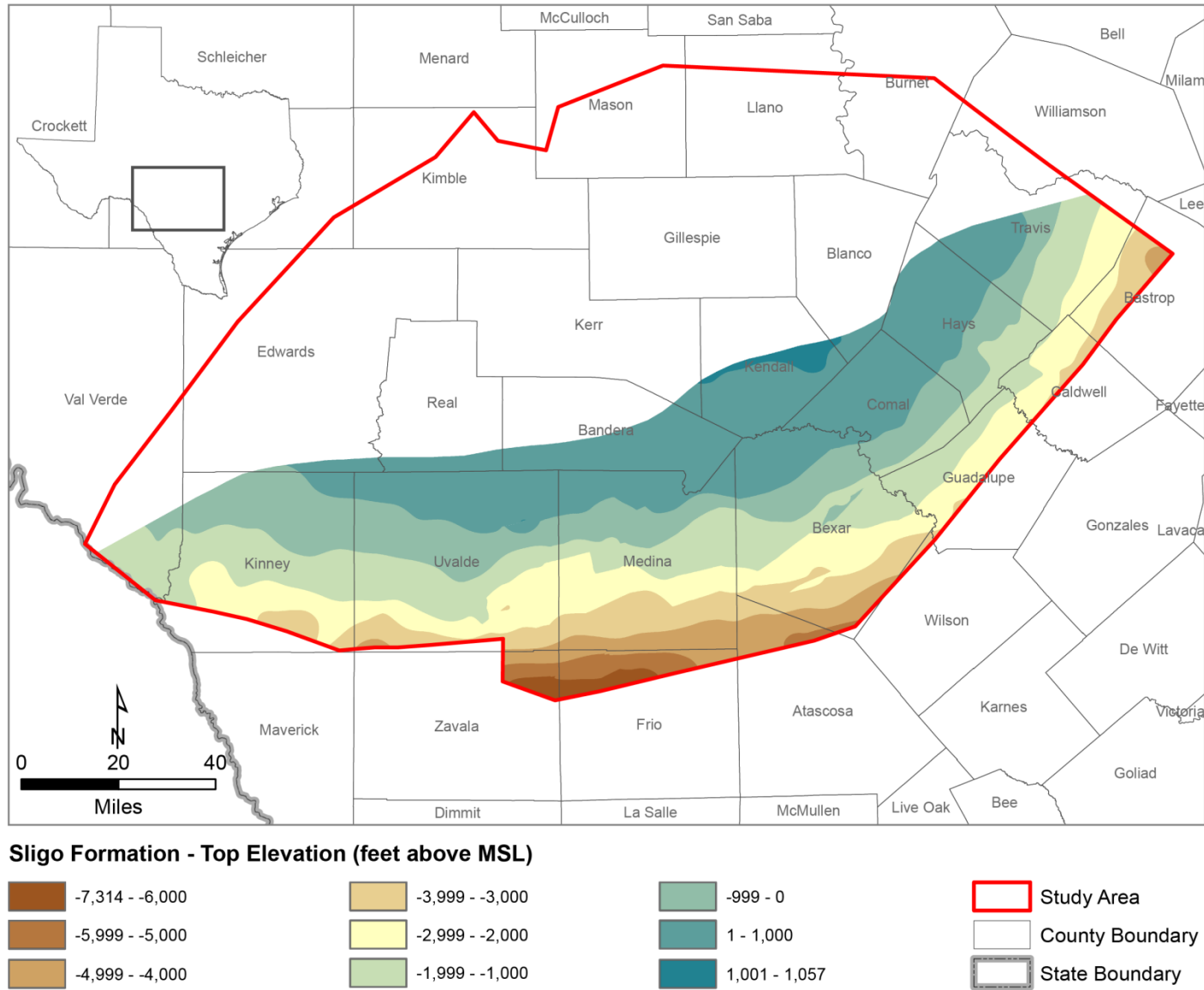

Figure 4.1.20 The elevation (in feet above mean sea level (MSL)) of the top of the Sligo Formation.

Conceptual Model Report for the Hill Country Trinity Aquifer
Groundwater Availability Model

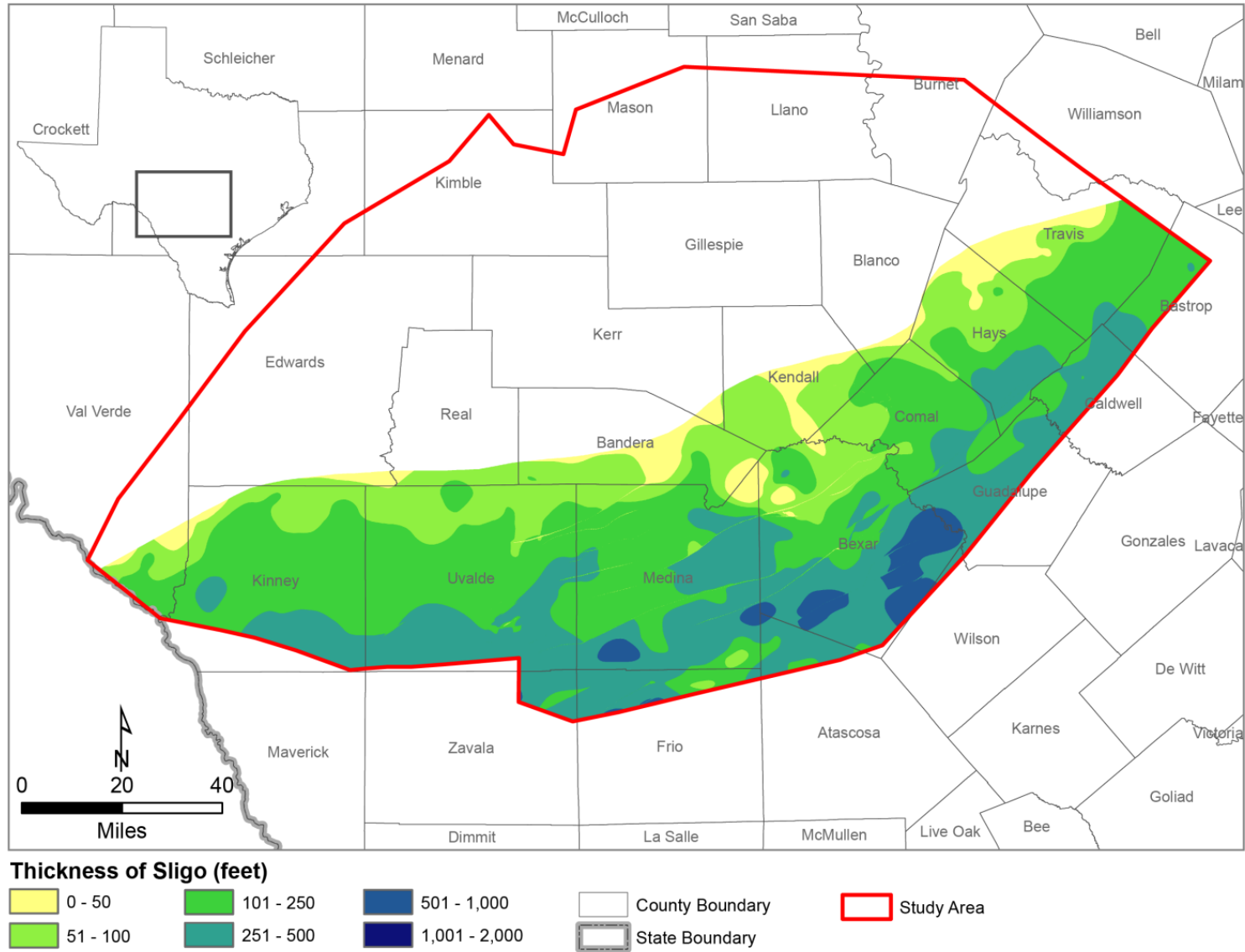

Figure 4.1.21 Thickness (in feet) of the Sligo Formation.

Conceptual Model Report for the Hill Country Trinity Aquifer
Groundwater Availability Model

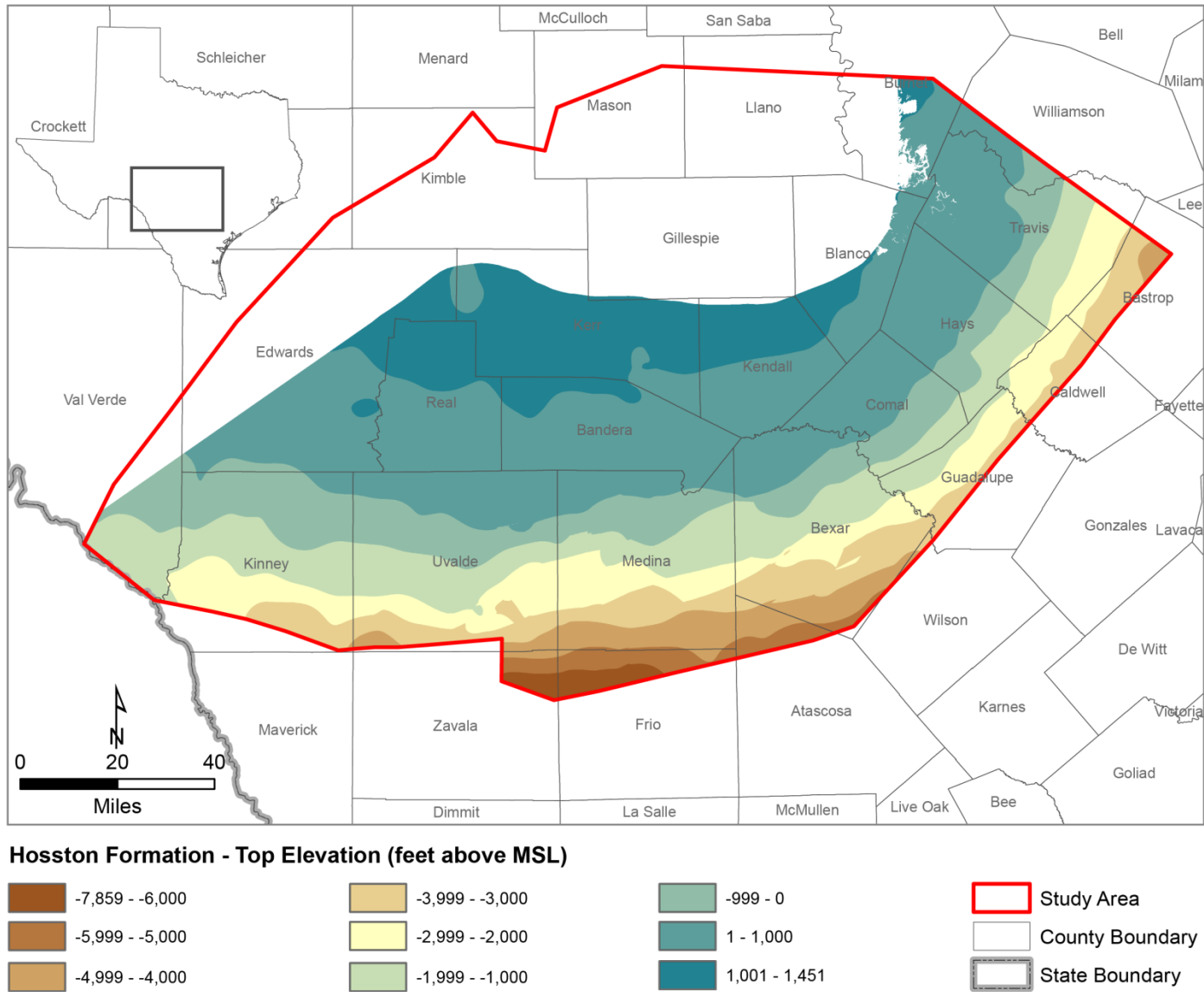

Figure 4.1.22 The elevation (in feet above mean sea level (MSL)) of the top of the Hosston Formation.

Conceptual Model Report for the Hill Country Trinity Aquifer
Groundwater Availability Model

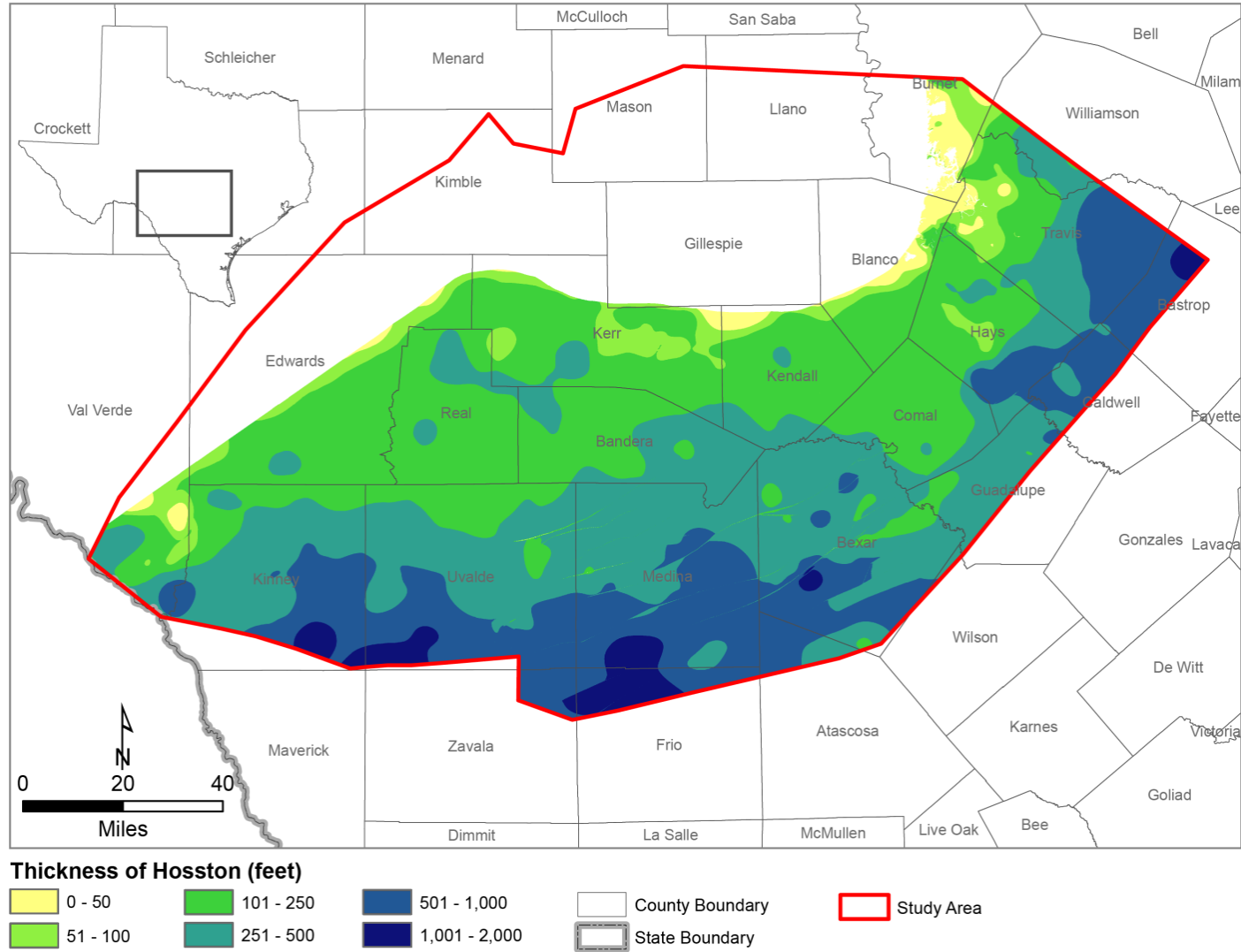

Figure 4.1.23 Thickness (in feet) of the Hosston Formation.

Conceptual Model Report for the Hill Country Trinity Aquifer
Groundwater Availability Model

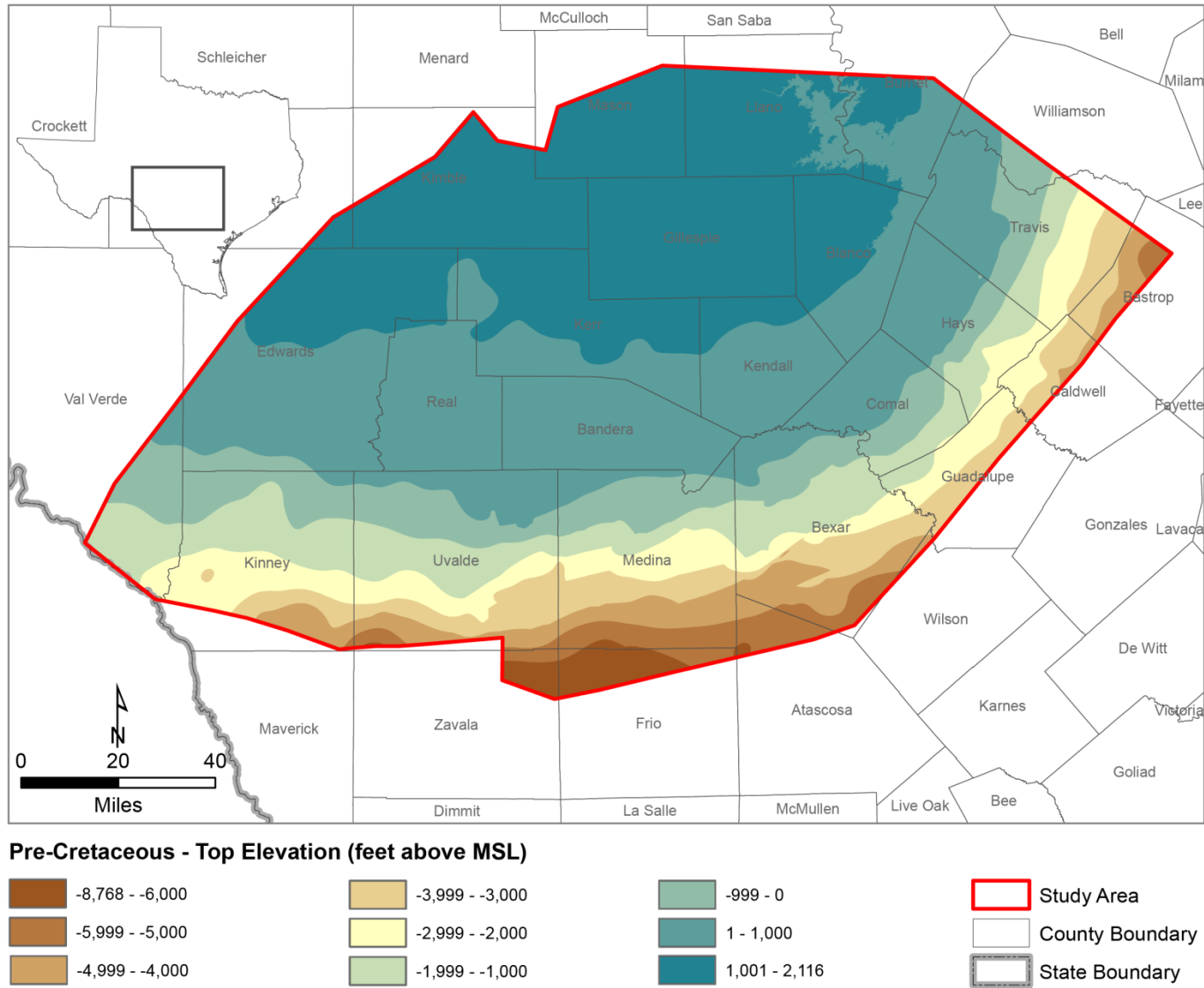

Figure 4.1.24 The elevation (in feet above mean sea level (MSL)) of the top of the Pre-Cretaceous.

Conceptual Model Report for the Hill Country Trinity Aquifer
Groundwater Availability Model

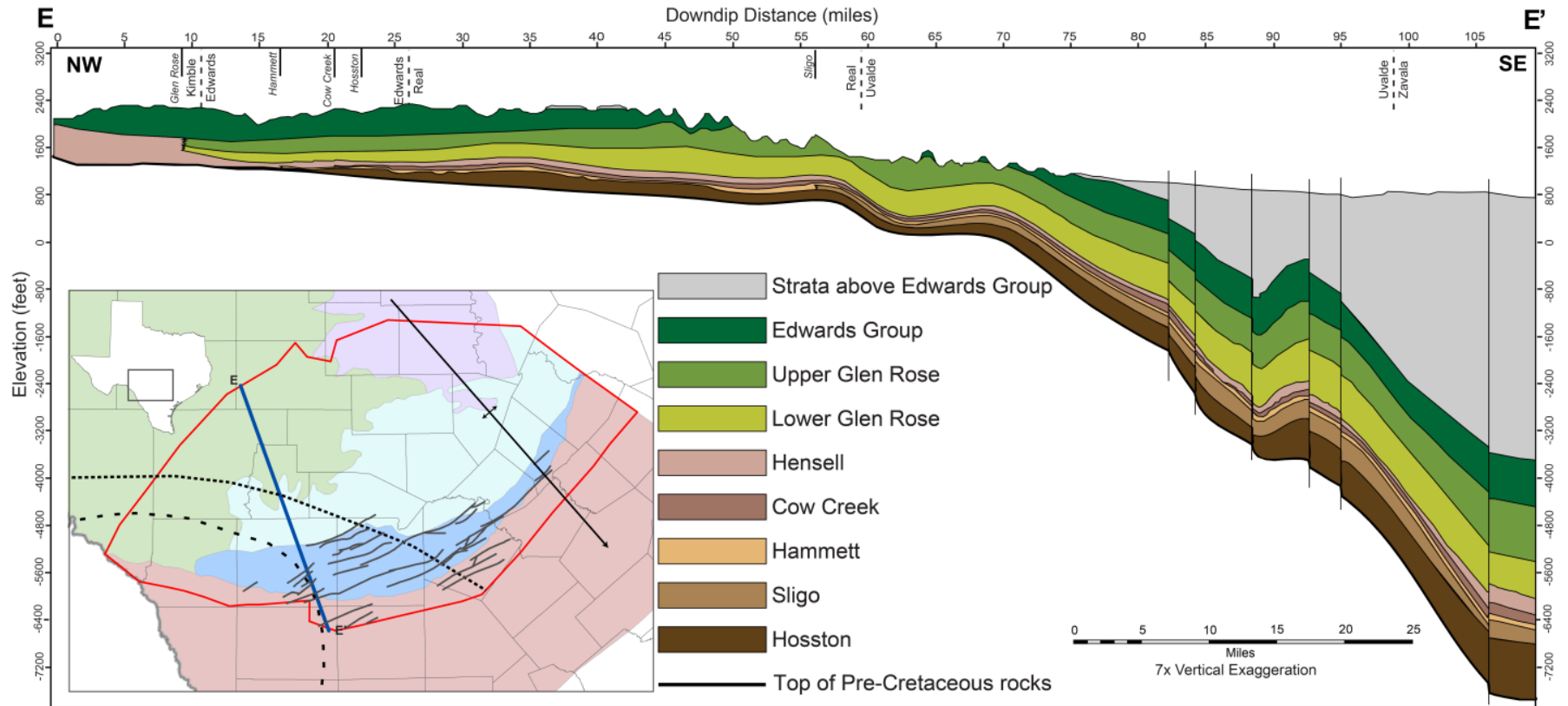

Figure 4.1.25 E-E' cross-section through the HCT hydrostratigraphic framework model.

Conceptual Model Report for the Hill Country Trinity Aquifer Groundwater Availability Model

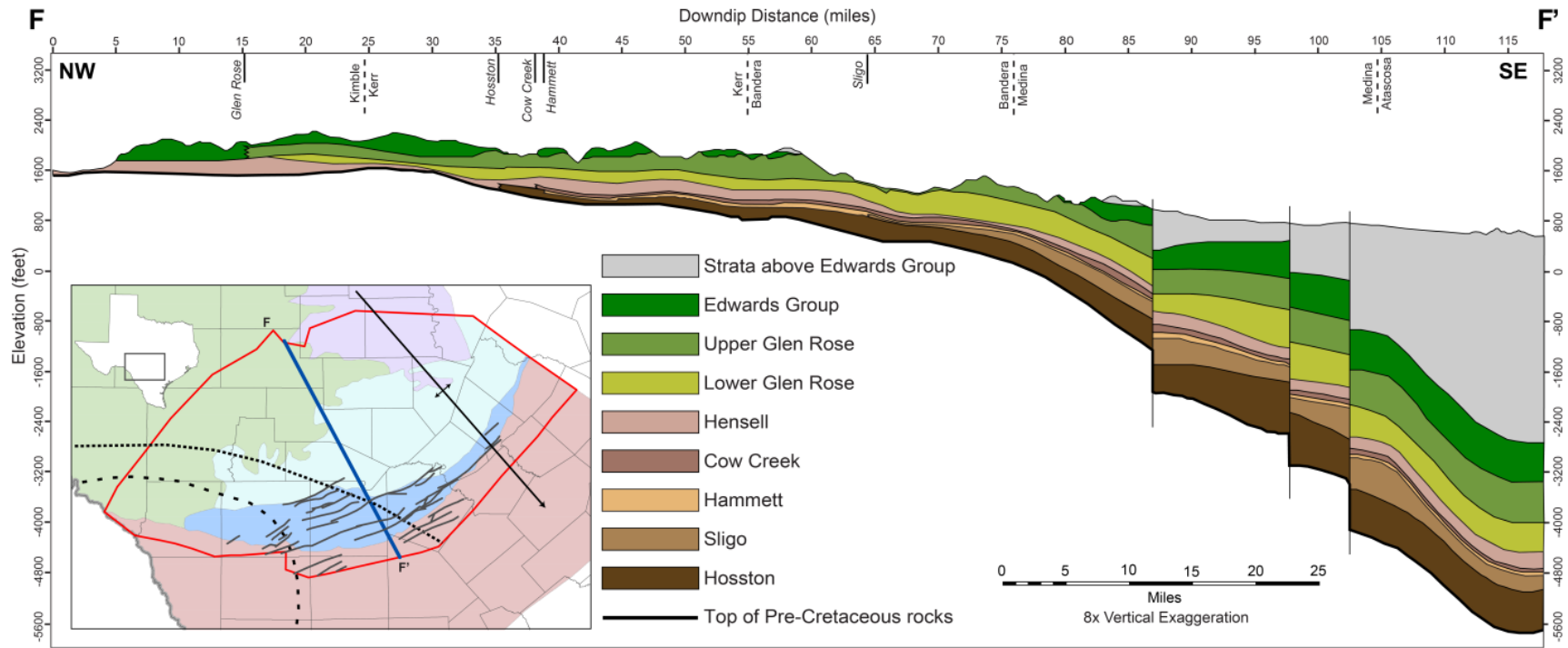

Figure 4.1.26 F-F' cross-section through the HCT hydrostratigraphic framework model.

Conceptual Model Report for the Hill Country Trinity Aquifer
Groundwater Availability Model

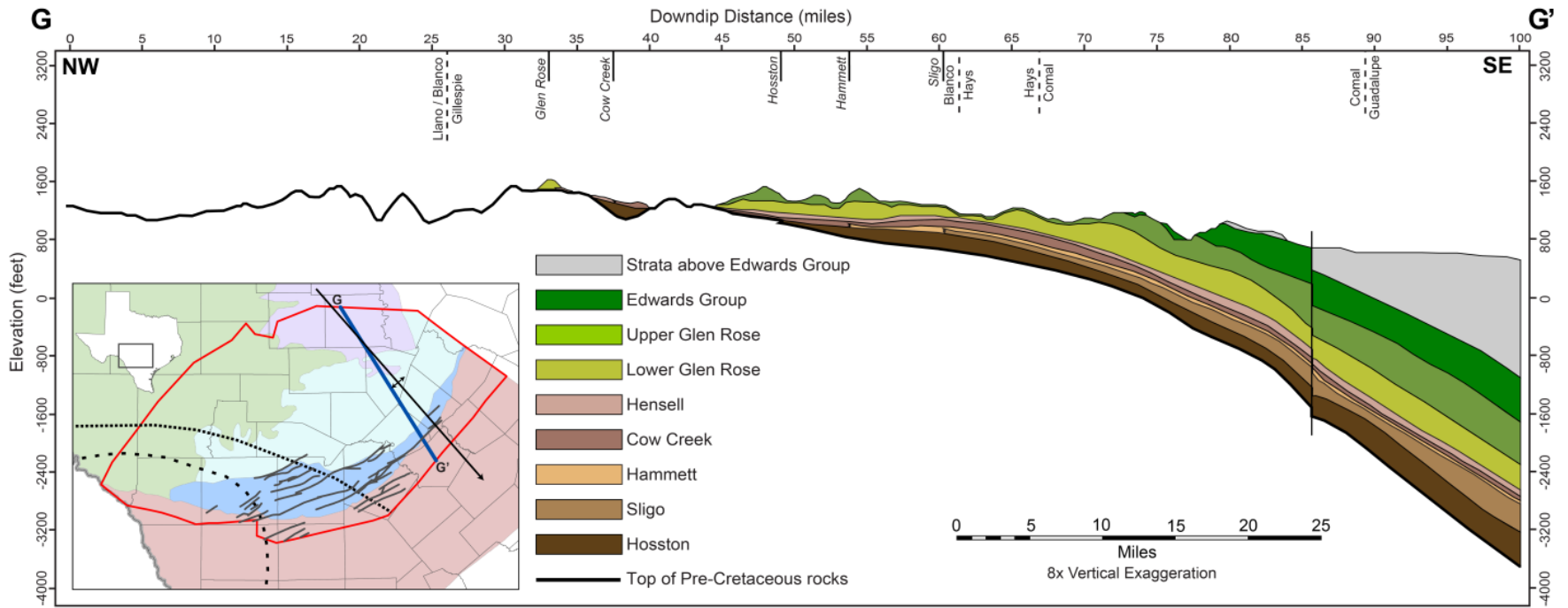

Figure 4.1.27 G-G' cross-section through the HCT hydrostratigraphic framework model.

4.2 Water-level Elevations and Groundwater Flow

This section discusses water-level elevations and groundwater flow in the Trinity hydrostratigraphic units of the current study area. The water-level elevations in the overlying Edwards hydrostratigraphic unit in the extent of the Edwards-Trinity (Plateau) Aquifer are also discussed. The Edwards-Trinity (Plateau) Aquifer is hydraulically connected to the Hill Country portion of the Trinity Aquifer, so this information is necessary for any future groundwater model based on the current study area to accurately represent regional groundwater flow. This section also includes some discussion of the Edwards hydrostratigraphic unit in the extent of the Edwards (Balcones Fault Zone) Aquifer because there is potentially significant lateral flow between Trinity hydrostratigraphic units and the Edwards hydrostratigraphic unit in that region. The following subsections provide the sources used to collect water-level data, discuss and present an estimate of the pre-development water-level elevation, discuss available transient water-level data and present an analysis of select transient data, present estimated historical water-level elevation contours, and discuss water-level elevation calibration targets.

Due to the size and complexity of the study area, the region was divided into three zones for discussion purposes. These zones are shown. The “Hill Country Trinity” region refers to the central portion of the study area, coincident with the TWDB extent of the Hill Country portion of the Trinity Aquifer within the study area. The “Edwards-Trinity (Plateau)” region refers to the western portion of the study area, coincident with the TWDB extent of the Edwards-Trinity (Plateau) Aquifer within the study area. The “Edwards (Balcones Fault Zone)” region refers to the southern portion of the study area, coincident with the TWDB extent of the Edwards (Balcones Fault Zone) Aquifer within the study area. Note that, for the purposes of this discussion, both the Edwards-Trinity (Plateau) region and the Edwards (Balcones Fault Zone) region extend beyond the current official aquifer extents to the southern boundary of the study area.

4.2.1 *Assigning wells to hydrostratigraphic units*

The stratigraphic surfaces developed for this report (see Section 4.1) represent a major update to the understanding of geological structure in the HCT region. Therefore, in the current analysis, wells were assigned to aquifers based on these newly-developed stratigraphic surfaces rather than relying on aquifer assignments in the source datasets. This process was also necessary to standardize the assigned hydrostratigraphic unit names for all wells, as the data sources use different naming conventions for the same formations and aquifers. For this reason, water-level elevations could only be considered for the current analysis if wells had depth or open interval information available. When open-interval information was available, the water-level elevation well was assigned to a stratigraphic layer if the entire screen fell within that layer. When only total depth information was available, a water-level elevation well was assigned to a stratigraphic layer if the total depth fell within the aquifer. However, if the distance between the total depth and the bottom of the overlying layer was less than the average open-interval length for the assigned stratigraphic layer, that well data were not considered representative of the stratigraphic layer.

An exception to this methodology was implemented for the Edwards (Balcones Fault Zone) Aquifer extent. For the purposes of the current analysis, if a well fell in the Edwards (Balcones Fault Zone) Aquifer extent and had an Edwards (Balcones Fault Zone) Aquifer designation in its

Conceptual Model Report for the Hill Country Trinity Aquifer Groundwater Availability Model

source dataset, that well was not used for any analysis of the Trinity hydrostratigraphic units. This was implemented because the well assignment process used in the current analysis did assign some of these wells to Trinity hydrostratigraphic units, and they were anomalous in water-level elevation and hydraulic properties compared to neighboring Trinity wells. As the Edwards (Balcones Fault Zone) Aquifer is easily distinguishable from Trinity hydrostratigraphic units in this region, an Edwards (Balcones Fault Zone) Aquifer designation in a source dataset was considered to be reasonably reliable. It was assumed that the erroneous well assignments from the current methodology were due to uncertainty caused by severe offsets in the stratigraphic surfaces representing the faulted Edwards (Balcones Fault Zone) region, coupled with uncertainty in well location, which affects the estimated depth from ground surface of the well open-interval or well bottom. The current well assignment methodology is assumed to be reliable in the rest of the study area outside the Edwards (Balcones Fault Zone) region, as the stratigraphic surfaces are smoother, and correspondingly fewer anomalies were noted.

The following discussion is organized by hydrostratigraphic unit according to Figure 2.2.1. Wells in the Edwards hydrostratigraphic unit are completed in the Edwards Limestone in either the Edwards (Balcones Fault Zone) region or the Edwards-Trinity (Plateau) region. Wells in the Upper Trinity hydrostratigraphic unit are completed in the upper member of the Glen Rose Formation. Wells in the Middle Trinity hydrostratigraphic unit are completed in lower member of the Glen Rose Formation, Hensell Sand, Cow Creek Limestone, or some combination of the three. Wells in the Lower Trinity hydrostratigraphic unit are completed in the Hammett Shale, the Sligo Formation, the Hosston Sand, or some combination of the three. Well data were only considered representative of a hydrostratigraphic unit if the well was entirely screened in that hydrostratigraphic unit, with the following exceptions. If a well intersected Hammett Shale but was otherwise completely screened in the Middle Trinity formations, it was considered representative of the Middle Trinity hydrostratigraphic unit if the majority of the screen was not in the Hammett Shale. This assumes that the Hammett Shale, which acts as a confining layer, contributes very little to productivity at that well location. If a very small portion of a well open-interval (less than 10 percent) intersected either the Pre-Cretaceous basement layer or the layer above the Edwards hydrostratigraphic unit, but was otherwise completely screened in one of the Trinity hydrostratigraphic units, the well was considered representative of that hydrostratigraphic unit. This was considered a reasonable assumption because, in the context of this report, the Pre-Cretaceous basement layer and the layer above the Edwards hydrostratigraphic unit generally serve as upper and lower boundaries for the Edwards and Trinity hydrostratigraphic units rather than as hydrologically active layers themselves. However, the cutoff for this assumption was purposefully small to avoid erroneously including wells that are actually completed in shallow alluvium or in deeper permeable units, like the Ellenburger-San Saba Aquifer in the northern portion of the study area.

4.2.2 Data Sources

Multiple sources were queried for water-level elevation measurements in the current study area, including:

- TWDB groundwater database (TWDB, 2017b)
- TWDB submitted drillers reports database (TWDB, 2017d)
- TWDB Brackish Resources Aquifer Characterization System (BRACS) well database (TWDB, 2017a)

Conceptual Model Report for the Hill Country Trinity Aquifer
Groundwater Availability Model

- U.S. Geologic Survey National Water Information System database (USGS, 2017)
- Texas Commission on Environmental Quality Public Water Supply well database (TCEQ, 2015)
- Water-level data received from groundwater conservation districts in the study area, including individual records and a compilation of Middle Trinity 2009 water-level data from Barton Springs Edwards Aquifer Conservation District (Hunt and others, 2010)
- Water-level data collected for a groundwater model in North Medina County (Young and others, 2005).

The TWDB maintains multiple databases of groundwater wells in the state. The TWDB groundwater database (TWDB, 2017b) is the most useful for long-term, water-level elevation analysis, as it includes historical time series of water-level elevation measurements collected by the TWDB and various state and local entities, including groundwater conservation districts. Water-level elevation measurements are also available from the TWDB submitted drillers reports database (TWDB, 2017d), which includes water-level elevation information for water wells drilled within the state. However, this database generally only contains one water-level elevation per well, recorded at the time of drilling. Water-level elevation measurements are also available from the TWDB Brackish Resources Aquifer Characterization System (BRACS) database (TWDB, 2017a). However, like the submitted drillers database, there are few transient water-level elevation measurements available. Because there is some overlap between these three databases, care was taken to remove duplicate wells and water-level elevation measurements.

The U.S. Geologic Survey maintains the National Water Information System database (USGS, 2017), which provides historical time series of water-level elevation measurements from their national well monitoring network. This database overlaps with the TWDB groundwater database (TWDB, 2017b), so some duplicate wells and water-level elevation measurements had to be removed.

The Texas Commission on Environmental Quality maintains a Public Water Supply well database (TCEQ, 2015), which provides water-level elevation measurements for public water supply wells in the state. This database does overlap with the TWDB groundwater database (TWDB, 2017b), so some duplicate wells and water-level elevation measurements had to be removed.

The study area intersects twenty-three groundwater conservation districts (Figure 2.0.5). During stakeholder meetings and other outreach efforts for the current project, all districts were invited to submit relevant water-level data. However, as most districts already coordinate with the TWDB's groundwater monitoring program, many received district water-level elevations records were duplicates of records in the TWDB groundwater database (TWDB, 2017b). In addition, received water-level elevation records could only be considered if the wells had enough completion information to assign to the current hydrostratigraphic units. Some usable non-duplicate water-level elevations were obtained from a water-level elevation monitoring dataset received from Hays-Trinity Groundwater Conservation District and a water-level database compiled as part of Hunt and Smith (2010) received from Barton Springs Edwards Aquifer Conservation District. In general, because most groundwater conservation districts only recently began monitoring activities, or in some cases, only recently were formed, groundwater conservation district data pertains to recent water-level elevations collected in the past five to ten years, rather than historical water-level elevations.

Conceptual Model Report for the Hill Country Trinity Aquifer Groundwater Availability Model

The number of wells with water-level data and the number of water-level measurements for those wells by hydrostratigraphic unit, region, and decade are summarized in Table 4.2.1, Table 4.2.2, Table 4.2.3, and Table 4.2.4. The spatial distribution of wells with water-level data for the Edwards, Upper Trinity, Middle Trinity and Lower Trinity hydrostratigraphic units are shown in Figure 4.2.2, Figure 4.2.3, Figure 4.2.4, and Figure 4.2.5, respectively. Wells and water-level measurements in the Edwards hydrostratigraphic unit are densely distributed in both the Edwards (Balcones Fault Zone) region and the Edwards-Trinity (Plateau) region. However, the Edwards-Trinity (Plateau) region has far fewer long-term (greater than 10 years) water-level elevation records available than the Edwards (Balcones Fault Zone) region. Wells and water-level measurements in the Upper Trinity hydrostratigraphic unit are distributed in dense clusters along the Edwards region in Travis, Hays, Comal and Medina counties and in the Edwards-Trinity (Plateau) region in Gillespie, Kimble, Kerr, Real, Edwards and Val Verde counties. However, there are very few long-term water-level elevation records for the Upper Trinity hydrostratigraphic unit available anywhere in the study area except a cluster in Val Verde County. Wells and water-level measurements in the Middle Trinity hydrostratigraphic unit are densely distributed across all of the Hill Country Trinity region and along the northern edge of the Edwards region. There are few measurements in the Edwards-Trinity (Plateau) region except for dense clusters in Real County and along outcrop areas in Kimble County. Wells and water-level measurements in the Lower Trinity hydrostratigraphic unit are densely distributed along the southern portion of the Hill Country Trinity region in Travis, Hays, Comal, northwestern Bexar, and Bandera counties. There are some measurements along the northern edge of the Edwards region, but almost none available in the Edwards-Trinity (Plateau) region. There are few long-term, water-level elevation records for the Lower Trinity hydrostratigraphic unit available outside small clusters in Travis, Hays, Kendall, Bandera and Kerr counties.

The temporal distribution of the number of wells with water-level measurements by decade and the number of water-level measurements in each hydrostratigraphic unit by decade are tabulated in Figure 4.2.6 and Figure 4.2.7, respectively. These values are also shown in Figure 4.2.6a and b, Figure 4.2.7a, and b for the Edwards, Upper Trinity, Middle Trinity and Lower Trinity hydrostratigraphic units, respectively. While water-level elevations in the Edwards hydrostratigraphic unit have been measured regularly since the 1930s/1940s, the majority of water-level elevations for the Trinity hydrostratigraphic units weren't measured until recently. Regular measurement of water-level elevations in the Middle Trinity hydrostratigraphic unit began in the 1990s, while measurements for the Upper and Lower Trinity hydrostratigraphic units did not begin in earnest until the 2000s. There are still very few measurements for the Upper Trinity hydrostratigraphic unit, even in the 2010s.

4.2.3 Creation of Water-Level Contours

Using the water-level elevation measurements compiled for the current project as control points, water-level elevation surfaces were created using the TopoToRaster and Focal Statistics tools and contoured using the Contour tool in ESRI ArcMap 10.3. Water-level elevation contours were created for each hydrostratigraphic unit for selected years (see Section 4.2.4 and Section 4.2.5). However, contours were not created unless at least 10 water-level elevation control points were available for a selected hydrostratigraphic unit and time period. The Trinity hydrostratigraphic units underlying the Edwards hydrostratigraphic unit in the Edwards-Trinity (Plateau) region are assumed to be contiguous with and hydraulically connected to the Trinity hydrostratigraphic units in the Hill Country Trinity region. Therefore, one continuous water-level elevation surface

Conceptual Model Report for the Hill Country Trinity Aquifer Groundwater Availability Model

was contoured across these two regions for each hydrostratigraphic unit. This is consistent with previous water-level elevation contours created in the study area, including Mace and others (2000), Kuniansky and Ardis (2004), and Jones and others (2011).

Unlike previous regional studies of the HCT Aquifer, the current study area also includes the Edwards region. Large fault offsets in the Edwards region can strongly influence flow within Trinity hydrostratigraphic units across the transition from the Hill Country Trinity region to the Edwards region, but the exact mechanisms are unclear. Significant lateral flow is assumed from the Trinity hydrostratigraphic units into the Edwards hydrostratigraphic unit where they are juxtaposed due to faulting (Mace and others, 2000; Kuniansky and Ardis, 2004; Jones and others, 2011). In this scenario, water-level elevations in Trinity hydrostratigraphic units might be more continuous with the water-level elevations in the Edwards hydrostratigraphic unit than with those in the offset Trinity units below the Edwards hydrostratigraphic unit. However, for the purposes of this report, water levels in each hydrostratigraphic unit were contoured separately. The contouring methodology used in the current study creates topographically smooth water-level elevation contours across the entire study area for each hydrostratigraphic unit and so may not fully address all the local complexities of structure-induced groundwater flow or discontinuities in the hydrostratigraphic units, particularly across the boundary between the Hill Country Trinity region and the Edwards region. The water-level elevations for the Edwards hydrogeologic unit were also continuously contoured across the transition from the Edwards-Trinity (Plateau) Aquifer to the Edwards (Balcones Fault Zone) Aquifer in Kinney County. However, the division between these two aquifers is based on groundwater topography rather than structure, so these contours are assumed to be representative of local water-level trends across the transition between these two regions.

4.2.4 Pre-development Water-Level Contours

Pre-development conditions are defined as those existing in the aquifer before the natural flow of groundwater was disturbed by artificial discharge via pumping. In GAMs, pre-development conditions are often modeled as a steady-state stress condition under the assumption that a long-term average of the seasonal and interannual fluctuations in recharge to the aquifer is balanced by the long-term average of fluctuations in natural discharge from the aquifer.

In some portions of the study area, pumping in the Trinity hydrostratigraphic units of the Hill Country Trinity region and the Edwards-Trinity (Plateau) region began as early as the 1930s/1940s (Section 4.6.2). However, water-level elevations measured prior to the actual start of pumping and representative of pre-development conditions in the study area are scarce and insufficient to construct pre-development water-level elevation contours for the aquifer. For this reason, earlier studies and modelling efforts in the study area used approximations for “near-predevelopment” conditions. Bush and others (1993) and Barker and Ardis (1996) use water-level elevations measured between 1915 and 1969. They do note that these water-level elevations may be affected by groundwater development in Bexar County. Mace and others (2000) used water-level elevations measured in a 20-year window around 1975 (1965-1985) to approximate steady-state groundwater conditions. Jones and others (2011) used an 8-year window around 1980 (1977-1985) to approximate steady-state groundwater conditions.

For the purposes of this analysis, water-level elevations prior to 1975 were considered for developing the estimated pre-development water-level contours. If multiple measurements prior to 1975 were available for a well, the maximum of those measurements was used. Individual

Conceptual Model Report for the Hill Country Trinity Aquifer Groundwater Availability Model

water-level elevations measured prior to 1975 were not used if they were taken during a drought year. Drought years were defined using Lowry (1959), which describes Texas droughts that occurred in the late 18th and 19th centuries. The current study area falls in the affected zone for most of the droughts described in that bulletin, including major droughts in the 1930s and 1950s.

The locations of springs and streams were also considered, as Barker and Ardis (1996) note that these are important controls on water-level elevations in the Edwards-Trinity Aquifer system. Spring locations that fell within an aquifer outcrop were used to constrain the pre-development head for that aquifer. The surface elevations for each spring location, based on the 10-meter DEM, were used as additional control points for the pre-development head. Perennial stream segments, as defined in the NHDPlus hydrography dataset (USEPA and USGS, 2012), provided additional constraints for the pre-development water-level elevations. Perennial stream segments that intersected an aquifer outcrop were sampled at 25-foot intervals and a surface elevation was assigned to each point, based on the current project's digital elevation model (DEM) surface. These elevations were used as additional control points for the pre-development head.

Edwards hydrostratigraphic unit

For this analysis, the Edwards hydrostratigraphic unit refers to the Edwards Limestone occurring in both the Edwards-Trinity (Plateau) Aquifer and the Edwards (Balcones Fault Zone) Aquifer. The estimated pre-development water-level elevation contours and the locations of the control points used to create the contours for the Edwards hydrostratigraphic unit are shown in Figure 4.2.8. The estimated pre-development water-level elevations in the Edwards-Trinity (Plateau) region range from a high of about 2,100 feet above mean sea level in the western central portion of the study area in Real County to a low of around 1,000 feet above mean sea level in the southwestern portion of the study area in Kinney County. In general, the contour lines in the Edwards-Trinity (Plateau) region show groundwater flowing south and southwest. In the Edwards (Balcones Fault Zone) region, water-level elevations range from a high of about 1,000 feet above mean sea level in the outcrop and to a low of around 500 feet above mean sea level in the eastern subcrop in Caldwell and Bastrop counties. The contour lines in the Edwards (Balcones Fault Zone) region show groundwater flowing downdip towards the south and southeast.

Upper Trinity hydrostratigraphic unit

The estimated pre-development water-level elevation contours and the locations of the control points used to create the contours for the Upper Trinity hydrostratigraphic unit are shown in Figure 4.2.9. In the Edwards-Trinity (Plateau) region, the estimated pre-development water-level elevations range from a high of about 2,000 feet above mean sea level at the north central end of the hydrostratigraphic unit in Kimble and Gillespie counties to a low of around 1,000 feet in the southwestern portion in Kinney and Val Verde counties. In general, the contour lines in the Edwards-Trinity (Plateau) region show groundwater flowing south and southwest, except where it intersects erosional drainages and flow instead towards the Nueces, Frio, or Sabinal rivers. In the HCT region, the estimated pre-development water-level elevations range from a high of around 1,700 feet along the boundary with the Edwards-Trinity (Plateau) region to a low of around 600 feet at the eastern end of the study area near the Colorado River in Travis County. In general, the contour lines in the HCT region show groundwater flowing east and southeast, generally following topography. The contour lines in the Edwards (Balcones Fault Zone) region show similar east and southeast groundwater trends continuing across the HCT region boundary,

but since there are few control points, it is unclear if this is representative of actual groundwater behavior in this region.

Middle Trinity Hydrostratigraphic Unit

The estimated pre-development water-level elevation contours and the locations of the control points used to create the contours for the Middle Trinity hydrostratigraphic unit are shown in Figure 4.2.10. In the Edwards-Trinity (Plateau) region, the estimated pre-development water-level elevations range from a high of about 1,800 to 1,900 feet above mean sea level at the northern edge of the hydrostratigraphic unit along the outcrop in Gillespie and Kimble counties to a low of around 1,100 feet in the western portion in Val Verde County. In general, the contour lines in the Edwards-Trinity (Plateau) region show groundwater flowing south and southwest, although this trend is largely driven by a single data point in Val Verde County and so may not reflect true conditions. There is also an area of northward flow towards the Llano River in the northern outcrop in Kimble County. In the Hill County Trinity Aquifer region, the estimated pre-development water-level elevations range from 1,500 feet above mean sea level along the boundary with the Edwards-Trinity (Plateau) region to about 600 feet above mean sea level at the eastern end of the study area near the Colorado River in Travis County. In general, the contour lines in the HCT Aquifer region show groundwater flowing east and southeast, following topography towards the Edwards (Balcones Fault Zone) region. However, an area in Travis County appears to drain towards the Colorado River and an area in Kendall and Comal counties appears to drain towards the Guadalupe River. The contour lines in the Edwards (Balcones Fault Zone) region show similar east and southeast groundwater trends continuing across the HCT region boundary, but since there are few control points, it is unclear if this is representative of actual groundwater behavior in this region.

Lower Trinity Hydrostratigraphic Unit

The estimated pre-development water-level elevation contours and the locations of the control points used to create the contours for the Lower Trinity hydrogeologic unit are shown in Figure 4.2.11. Based on available information, these contours only cover the HCT region. The estimated pre-development water-level elevations range from a high of about 1,500 feet above mean sea level at the northern end of the aquifer in Kerr and Kendall counties to a low of about 600 ft at the eastern end of the study area near the Colorado River in Travis County. In general, the contour lines show groundwater flowing east and southeast, following topography towards the Edwards (Balcones Fault Zone) region. The contour lines and several control points in the Edwards (Balcones Fault Zone) region show a southeast groundwater trend continuing across the HCT region boundary in Travis County.

4.2.5 Historical Water-level elevation Contours

Historical water-level elevation contours for the HCT Aquifer were estimated for the years 1990, 2000, and 2010. Water-level data are not available at regular time intervals in every well. Therefore, the coverage of water-level data for a particular month or even a year within an aquifer is sparse. Because the amount of available water-level data for a particular year of interest is typically not sufficient to interpolate a water-level elevation surface, the historical water-level elevation contours were developed based on data from a five-year window around the year of interest. The range of years used was 1988 through 1992 for the 1990 water-level elevations, 1998 through 2002 for the 2000 water-level elevation, and 2008 through 2012 for the

Conceptual Model Report for the Hill Country Trinity Aquifer
Groundwater Availability Model

2010 water-level elevations. If a well had multiple water-level elevation measurements during the range of years, the average of those measurements was used.

Edwards Hydrostratigraphic Unit

The estimated historical water-level elevation contours and the locations of the control points used to create the 1990, 2000, and 2010 contours for the Edwards hydrostratigraphic unit are shown in Figure 4.2.12, Figure 4.2.13, and Figure 4.2.14, respectively. In the Edwards-Trinity (Plateau) region, water-level elevations estimated for the Edwards hydrostratigraphic unit in 1990 range from a high of around 2,000 feet above mean sea level in the northwestern portion of the hydrostratigraphic unit in southern Kimble, northern Real, northern Edwards and western Kerr counties to around 1,000 feet in the southwestern portion in Val Verde and Kinney counties. In general, the contour lines in the Edwards-Trinity (Plateau) region show groundwater flowing south and southwest, along this hydraulic gradient, or east and southeast along topography towards the boundary with the HCT region. Water-level elevations estimated for the Edwards hydrostratigraphic unit in 2000 follow the same general trends in the Edwards-Trinity (Plateau) region. Water-level elevations estimated for the Edwards hydrostratigraphic unit in 2010 also follow the same general trends as previous years, but these are more difficult to interpret as there are many more high-density localized drawdown and recovery variations that may not be representative of the regional groundwater flow. There is some evidence of drawdown in central Kerr County along the boundary with the HCT region, as well as several areas of aquifer recovery, including Gillespie County and southern and western Edwards County. The slight groundwater divide along the boundary between the Edwards-Trinity (Plateau) Aquifer subcrop and the Edwards (Balcones Fault Zone) Aquifer subcrop in Kinney County is evident in all time periods.

In the Edwards (Balcones Fault Zone) region, water-level elevations estimated for the Edwards hydrostratigraphic unit in 1990 range from a high of around 1,200 feet along the northern edge of the outcrop in Medina County to lows of around 500 to 600 feet in the subcrop in Bexar, Comal, Hays and Travis counties. In general, the contour lines show groundwater flowing south and southeast, down from the outcrop into the subcrop. Water-level elevations estimated for the Edwards hydrostratigraphic unit in 2000 and 2010 follow the same general trends in the Edwards (Balcones Fault Zone) region, although there is some evidence of drawdown in the outcrop in Medina County.

Upper Trinity Hydrostratigraphic Unit

The estimated historical water-level elevation contours and the locations of the control points used to create the 1990, 2000, and 2010 contours for the Upper Trinity hydrostratigraphic unit are shown in Figure 4.2.15, Figure 4.2.16, and Figure 4.2.17, respectively. Across the Edwards-Trinity (Plateau) and HCT regions, water-level elevations estimated for the Upper Trinity hydrostratigraphic unit in 1990 range from a high of about 1,900 feet above mean sea level in eastern Kerr County to a low of 1,200 feet in Val Verde County. In general, the 1990 contour lines show groundwater flow from the northwestern Edwards-Trinity (Plateau) region towards the south towards Uvalde County or towards the southeast across the Upper Trinity outcrop in the HCT region towards the boundary with the Edwards (Balcones Fault Zone) region. Water-level elevations in 2000 range from a high around 2,000 feet above mean sea level in northern Edwards County to a low around 800 feet along the boundary with the Edwards (Balcones Fault Zone) region in Travis County. Water-level elevations estimated for the Upper Trinity hydrostratigraphic unit in 2000 indicate similar water-level elevations as 1990 but with higher

Conceptual Model Report for the Hill Country Trinity Aquifer
Groundwater Availability Model

water-level elevations in eastern Kerr County. Water-level elevations estimated for the Upper Trinity hydrostratigraphic unit in 2010 follow the same general trends as previous years, although there is some evidence of drawdown in southwestern Edwards County and increases in Kerr, Gillespie, and Real counties in the northwestern portion of the hydrostratigraphic unit. Some of the changes noted in 2000 and 2010 water levels may however be due to an increased number of control points in these areas.

In the Edwards (Balcones Fault Zone) region, there are insufficient control points for the Upper Trinity hydrostratigraphic unit in 1990 to interpret groundwater trends. The water-level elevations in 2000 range from about 1,200 feet above mean sea level along the northeastern edge of the region in Medina County to about 600 feet above mean sea level in Comal County. Water-level elevations estimated for the Upper Trinity hydrostratigraphic unit in 2010 follow the same general trends as 2000, although there is some evidence of drawdown in east-central Medina County. In general, the contour lines in the Edwards (Balcones Fault Zone) region for all time periods show east and southeast groundwater trends as a continuation of contours from across the HCT region boundary. There are not enough control points in this area in 1990 to confirm this, but additional control points in 2000 and 2010 do support this interpretation.

Middle Trinity Hydrostratigraphic Unit

The estimated historical water-level elevation contours and the locations of the control points used to create the 1990, 2000, and 2010 contours for the Middle Trinity hydrostratigraphic unit are shown in Figure 4.2.18, Figure 4.2.19, and Figure 4.2.20, respectively. In the Edwards-Trinity (Plateau) region, there are insufficient data to contour the western portion of this region, so the analysis focuses on the eastern portion of the region. Across the Edwards-Trinity (Plateau) and HCT regions, the water-level elevations estimated for the Middle Trinity hydrostratigraphic unit in 1990 range from a high of around 1,700 feet above mean sea level in Gillespie County to a low around 600 feet near the Colorado River in Travis County. In general, contour lines show groundwater flowing south from the Edwards-Trinity (Plateau) region towards the boundary with the Edwards (Balcones Fault Zone) region or southeast across the HCT region towards the boundary with the Edwards (Balcones Fault Zone) region. There is also evidence of drainage towards the Medina and Guadalupe rivers. Water-level elevations estimated for the Middle Trinity hydrostratigraphic unit in 2000 follow the same general trends as in 1990, although there is some evidence of drawdown in eastern Kerr County. There also lower water-levels in Travis County and higher water-levels in Kimble County but these changes may be due to the increased number of control points in these areas. Water-level elevations estimated for the Middle Trinity hydrostratigraphic unit in 2010 also follow the same general trends as previous years. Water-level elevations are higher in 2010 than 2000 in Real and western Kerr counties, but this change may be due to an increased number of control points in that area.

In the Edwards (Balcones Fault Zone) region, there are insufficient control points for the Middle Trinity hydrostratigraphic unit in 1990 to interpret groundwater trends. In both 2000 and 2010, the water-level elevations estimated for the Middle Trinity hydrostratigraphic unit range from a high of around 1,100 at the northern edge of the Edwards (Balcones Fault Zone) Aquifer outcrop in Medina County to a low around 400 to 500 feet in central Travis and Comal counties. In general, the contour lines in the Edwards (Balcones Fault Zone) region for all time periods show east and southeast groundwater trends as a continuation of contours from across the HCT region boundary. There are not enough control points in this area in 1990 to confirm this, but additional control points in 2000 and 2010 do support this interpretation.

Lower Trinity Hydrostratigraphic Unit

The estimated historical water-level elevation contours and the locations of the control points used to create the 1990, 2000, and 2010 contours for the Lower Trinity hydrostratigraphic unit are shown in Figure 4.2.21, Figure 4.2.22, and Figure 4.2.23, respectively. There are insufficient data to contour water-level elevations for the Lower Trinity hydrostratigraphic unit in the Edwards-Trinity (Plateau) region until 2010, so the analysis mostly focuses on the HCT region. Water-level elevations estimated for the Lower Trinity hydrostratigraphic unit in 1990 range from 1,400 feet above mean sea level in eastern Kerr County to a low of around 600 feet in Travis County. In general, contour lines show groundwater flowing southeast, from the northwest towards the boundary with the Edwards (Balcones Fault Zone) region. There is also evidence of eastern drainage towards the Colorado River in Travis County. Water-level elevations estimated for the Lower Trinity hydrostratigraphic unit in 2000 follow the same general trends as in 1990 although with higher water-level elevations in Kendall and Blanco counties. Water-level elevations estimated for the Lower Trinity hydrostratigraphic unit in 2010 use additional control points to characterize portions of the Edwards-Trinity (Plateau) region and show groundwater flowing to the south and southwest in Real County in that region. Otherwise, flow in the rest of the Hill Country region is similar to trends in previous years, although with steeper gradients to the southeast in the area near Kendall, Comal and Hays counties.

In the Edwards (Balcones Fault Zone) region, there were insufficient data to interpret groundwater trends for the Lower Trinity hydrostratigraphic unit in 1990 and 2000. Water-level elevations estimated for the Lower Trinity hydrostratigraphic unit in 2010 range from about 1,100 feet above mean sea level in northern Medina and Uvalde counties to a low of about 500 feet in Travis County. In general, the contour lines in the Edwards (Balcones Fault Zone) region show east and southeast groundwater trends as a continuation of contours from across the HCT region boundary. There are only a few available control points in the region in 2010, but these do support this interpretation.

4.2.6 *Transient Water-level Data in Individual Wells*

An evaluation of the transient behavior of water-level elevations in the study area was conducted using transient water-level data in wells. Transient data were considered to consist of ten or more water-level measurements in a given well over a period of ten or more years. The locations of wells with transient water-level data in the Edwards, Upper Trinity, Middle Trinity and Lower Trinity were shown previously in Figure 4.2.2, Figure 4.2.3, Figure 4.2.4, and Figure 4.2.5. All hydrographs for these wells could not be presented and discussed in the main body of the report. Instead, hydrographs for these wells, showing the transient water-level elevations and land-surface elevation, are provided in Appendix A.

The hydrographs discussed here were selected based on several criteria. First, a review of all hydrographs was conducted in order to select those with a long-term (greater than 10 years) record. Second, hydrographs were selected based on spatial location to cover as much of each hydrostratigraphic unit as possible. Third, an effort was made to select hydrographs with sufficient data to define a water-level trend and with data that appear to be free of measurements potentially impacted by drilling and/or pumping activities.

In addition to the water-level data (blue line and symbol), each hydrograph shown in Figure 4.2.24 through Figure 4.2.28 includes the elevation of the land surface (green line). The land-surface elevation is based on the value of the DEM surface at that well location. Including the

Conceptual Model Report for the Hill Country Trinity Aquifer Groundwater Availability Model

ground surface allows evaluation of the depth to groundwater in the well. For all hydrographs, the time scale of the x-axis is 1950 to 2020. The scale of the water-level elevation on the y-axis varies from hydrograph to hydrograph depending on the range of the observed data; however, the division of the y-axis is consistent at 10 feet.

Edwards Hydrostratigraphic Unit

Select hydrographs for wells completed in the Edwards hydrostratigraphic unit are shown in Figure 4.2.24. Only wells falling in the Edwards-Trinity (Plateau) region are included in this discussion of the Edwards hydrostratigraphic unit. Hydrographs from the Edwards (Balcones Fault Zone) region are not discussed but are included in Appendix A. In general, the Edwards hydrostratigraphic unit data in the Edwards-Trinity (Plateau) region show relatively flat water-level elevations, with typical fluctuations in water-level elevations of less than 10 feet over the period of record. These data show no long-term decline in water-level elevations, indicating that pumping has not had a long-term negative effect on water-level elevations on the Edwards hydrostratigraphic unit in the Edwards-Trinity (Plateau) region. Two wells (wells 7033604 and 5734702) show increases in water-level elevations over time. The increase in well 7033604 occurred over the period from 1965 to 1975 in Val Verde County and the increase in well 5734702 occurred over the period from 1990 to 2005 in Gillespie County.

Upper Trinity Hydrostratigraphic Unit

Select hydrographs for wells completed in the Upper Trinity hydrostratigraphic unit are shown in Figure 4.2.25. As long-term hydrographs in the Upper Trinity hydrostratigraphic unit are scarce, this figure includes all records with at least 10 measurements over at least 10 years. As a result, some of the hydrographs are of poor quality with spikes that potentially indicate the influence of pumping on the measurement. In particular, long-term groundwater behavior could not be reliably interpreted from well 743302 in Kinney County and well 6901702 in Real County. Hydrographs for selected wells in Val Verde County (wells 7025502, 7025603, 7026102, and 7026401) all show dramatic increases (50 to 150 feet) in water-level elevations in the Upper Trinity hydrostratigraphic unit around 1970. These increases generally occurred sometime during the period from 1965 to 1975. Well 7026102 does not include interim data between about 1970 and 2005, but it seems reasonable to assume the recovery happened over the same timeline as the other Val Verde County wells. These wells are all located near the Amistad Reservoir which was impounded in 1969, so these increases likely reflect the influence of the reservoir on the groundwater system in the area. In Hays County, well 5857401 showed a recovery of about 30 feet during the period from 1955 to 1960 but then a decline of about 10 to 15 feet from 1960 to the late 1980s. Well 5742306 in Gillespie County shows about 15-foot decline during the period from 1985 to 1995 but relatively flat water-level elevations before and after that period.

Middle Trinity Hydrostratigraphic Unit

Select hydrographs for wells completed in the western and west-central portion of the Middle Trinity hydrostratigraphic unit are shown in Figure 4.2.26. Wells in the west and west-central portions of the Middle Trinity hydrostratigraphic unit (wells 5625906, 5656805, 5751802, and 6918303) show relatively flat water-level elevations for most of the period of record, although two wells have shown recent declines in water-level elevations. Well 5751802 in Gillespie County showed a decline and recovery of about 20 feet in the 1990s and a more recent decline of about 10 feet from 2005 to 2015. Well 69118303 in Real County showed a slow 10-foot decline from 1985 to 2010, followed by a sharp 40-foot decline to the present. Wells in the central part of the study area (wells 6916201, 6801505, 5757703, and 5749701) have been steadily declining

Conceptual Model Report for the Hill Country Trinity Aquifer
Groundwater Availability Model

over the period of record. Wells in Kerr County have the greatest drawdowns, with almost 150 feet of decline over 40 years at well 6916201, about 100 feet decline over 30 years at well 5757703, and about 50 feet of decline over 30 years at well 6801505.

Select hydrographs for wells completed in the east and east-central portions of the Middle Trinity hydrostratigraphic unit are shown in Figure 4.2.27. Wells near outcrops of the Middle Trinity hydrostratigraphic unit (wells 6811103, 6811715, 5761803, and 5764702) show relatively stable water-level elevations over time, with typical fluctuations less than 10 feet. The other wells (wells 6912501, 5758706, 5758402, 5755401) show steady declines of 60 to 80 feet over a period of about 30 years. This indicates that wells near the outcrop of the Middle Trinity hydrostratigraphic unit are more resilient to negative effects from pumping than wells located farther in the subcrop, potentially due to the higher storage potential in the outcrop, as well as closer proximity to focused recharge from surface-water features.

Lower Trinity Hydrostratigraphic Unit

Hydrographs for selected wells completed in the Lower Trinity hydrostratigraphic unit are shown in Figure 4.2.28. Two wells (wells 6819208 and 5763702) show historical declines followed by recent periods of stable water-level elevations. Wells in Bandera County (wells 6916702 and 6924102) and Travis County (wells 5850120 and 5842802) show steady declines over time, with the greatest decline of about 300 feet in well 6924102 in Bandera County over a period of 30 years. Two wells in Kendall County (wells 6804909 and 6804916) show water-level elevations at two different time periods in the same area of the Lower Trinity hydrostratigraphic unit. Water-level elevations rose about 30 feet in well 6804909 from 1975 to 1995, but then water-level elevations declined sharply about 100 feet in the nearby well 6804916 from 2005 to 2015.

4.2.7 Transient Water-Level Calibration Targets

Recommended water-level calibration targets for use in numerical modeling are the wells with at least 10 water-level elevation measurements over at least 10 years of record. The locations of these wells are included in Appendix A. If these are not sufficient, the compilation of water-level elevation measurements for the current project can provide water-level records with shorter timeframes. However, the longer water-level elevation records are recommended as they represent the long-term groundwater behavior in the study area better than point measurements. The number of long-term calibration targets available for the transient model by hydrostratigraphic table is provided in Figure 4.2.25. Calibration targets in the Upper Trinity hydrostratigraphic unit are limited to the Edwards-Trinity (Plateau) region, whereas targets for the Middle Trinity and Lower Trinity hydrostratigraphic units are mostly limited to the HCT region.

4.2.8 Cross Formational Flow

The potential for flow between the Upper, Middle and Lower Trinity hydrostratigraphic units was investigated as well as cross-formational flow between the Trinity hydrostratigraphic units and underlying or overlying aquifers. Each of these is discussed in the following subsections.

4.2.8.1 Vertical Flow within the Trinity hydrostratigraphic units

Very low cross-formational flow is expected between the Upper, Middle and Lower Trinity hydrostratigraphic units in the study area. As discussed in Barker and Ardis (1996), the tight low-permeability interbeds in the Upper and Middle Trinity hydrostratigraphic units can severely

restrict vertical flow so that groundwater moves laterally along impermeable bedding (often discharging from seeps and springs) rather than percolating into the underlying Trinity hydrostratigraphic units. One study in north Bexar County estimated that the vertical hydraulic conductivity of these confining units of the Trinity Aquifer, including the Hammett Shale, Bexar Shale, and the clays and marls of upper member of the Glen Rose Limestone, was only around 0.0001 to 0.003 feet per day (W.E. Simpson Company and William F. Guyton Associates, 1993). Thus, the low-permeability clays and marls of the Upper Trinity hydrostratigraphic unit are thought to restrict flow into underlying units and the Hammett Shale restricts flow between the Middle and Lower Trinity hydrostratigraphic units. Anaya and Jones (2009) also considered the effect of this stratification on groundwater flow in the HCT region compared to other portions of the Edwards-Trinity (Plateau) Aquifer. They note that the shale, sand, and limestone transgressive-regressive sequence represented by the Upper, Middle and Lower Trinity sediments introduces significant vertical anisotropy compared to the thinner, but more homogenous Trinity Sands in the northwest portion of the Edwards-Trinity (Plateau) Aquifer (Anaya and Jones, 2009).

To evaluate the potential for vertical flow between the Trinity hydrostratigraphic units, water-level elevations from the current project's water-level elevation compilation were compared for closely spaced wells completed in different hydrostratigraphic units. These comparisons are shown in Figure 4.2.29. In western Kerr County, a Middle Trinity well has water-level elevations at least 100 feet below water-level elevations in two Upper Trinity wells, showing a clear separation between those units in the Edwards-Trinity (Plateau) region. In northwest Bandera County, a Middle Trinity well has water-level elevations greater than 200 feet below the water-level elevation in an Upper Trinity well.

The division between Trinity hydrostratigraphic units is not as clear in the HCT region. In a Middle Trinity well in Hays County, the water-level elevations are almost 300 feet above water-level elevations in a nearby Lower Trinity well. However, in another two Middle Trinity wells in Hays County, nearby Lower Trinity water-level elevations overlap the water-level elevations in the Middle Trinity hydrostratigraphic unit. Similar behavior occurs in east-central Bandera County, where two Middle Trinity wells are mostly above but sometimes overlap with water-level elevations in the nearby Lower Trinity wells. It is unclear if this behavior indicates natural flow between the Middle and Lower Trinity hydrostratigraphic units or if these wells may actually be screened over both units. The limited spatial coverage of appropriate well pairs with long-term measurements makes it difficult to reach significant conclusions regarding vertical flow between Trinity hydrostratigraphic units. However, at least a few examples agree with the literature in that they show high resistance to cross-formational flow, as evidenced by large differences in water-level elevations between units.

4.2.8.2 Cross-Formational Flow between the Trinity hydrostratigraphic units and Underlying or Overlying Aquifers

Given the low-permeability of the Upper Trinity hydrostratigraphic unit, little vertical flow is expected from the overlying Edwards hydrostratigraphic unit to the Middle and Lower Trinity hydrostratigraphic units. In the Edwards (Balcones Fault Zone) region, Trinity pumping tests under the Edwards unit have shown no drawdown in nearby Edwards wells (Hunt and others, 2010), indicating little connection between the Trinity and Edwards hydrostratigraphic units. Recent multiport measurements in the Edwards (Balcones Fault Zone) in Hays County indicated some communication between the Edwards hydrostratigraphic unit and the Upper Trinity

Conceptual Model Report for the Hill Country Trinity Aquifer
Groundwater Availability Model

hydrostratigraphic unit but no communication with the Middle Trinity hydrostratigraphic unit (Wong and others, 2014).

To evaluate the potential for vertical flow from the Edwards hydrostratigraphic unit in the Edwards-Trinity (Plateau) region, water-level elevations from wells completed in the Edwards hydrostratigraphic unit were compared to nearby wells completed in Trinity hydrostratigraphic units. These comparisons are also shown in Figure 4.2.29. In all cases, the Edwards wells have much higher water-level elevations than wells in any of the Trinity hydrostratigraphic units, indicating little communication between these units. The one exception is an Upper Trinity water-level elevation measurement in western Bandera County that is similar to nearby Edwards water-level elevations. However, it is unclear if this behavior indicates natural flow between the Edwards and Upper Trinity hydrostratigraphic units or if this well may actually be screened over both units.

Cross-formational flow between the Trinity and Edwards hydrostratigraphic units can also occur laterally, rather than vertically, where permeable blocks of these units are juxtaposed at the boundary of the Edwards (Balcones Fault Zone) region. Hunt and others (2007) noted that water levels were similar in the Edwards and Upper Trinity aquifers along the western edge of the Edwards Aquifer in Hays and Travis counties, indicating good hydraulic communication between the units. Dye tracing tests have also indicated lateral connections between the Upper Trinity and Edwards hydrostratigraphic units (Johnson and others, 2010). Previous groundwater models of the Trinity hydrostratigraphic units acknowledge this connection by implementing a discharge component from the Trinity hydrostratigraphic units in the HCT region into the Edwards hydrostratigraphic unit in the Edwards (Balcones Fault Zone) region. Kuniansky and Ardis (2004) simulated a flow of between 1,900 to 2,300 acre-feet per year per mile into the Edwards hydrostratigraphic zone along the fault zone, which they conceptualized as “equivalent to a low permeability seepage face with a slow drip of water per square foot of area.” Previous TWDB GAMs in the study area (Mace and others, 2000; Jones and others, 2011) also included lateral flow into the Edwards hydrostratigraphic unit as a significant discharge component from the Trinity hydrostratigraphic units. However, Hunt and others (2015) found that flow can be laterally continuous within the Middle Trinity hydrostratigraphic unit across the boundary from the Hill Country portion of the Trinity Aquifer to the Barton Springs segment of the Edwards (Balcones Fault Zone) Aquifer. This indicates that lateral cross-formational flow from the Middle Trinity hydrostratigraphic unit into the Edwards hydrostratigraphic units is likely lower along that portion of the boundary than the area further west, in the San Antonio segment of the Edwards (Balcones Fault Zone) Aquifer.

The water-level elevation comparisons include one comparison between a Middle Trinity well in northern Medina County north of the Edwards (Balcones Fault Zone) region and a nearby Edwards well within the Edwards (Balcones Fault Zone) region. The water-level elevations in the Edwards well are higher than the water-level elevations in the Middle Trinity well, indicating a lack of direct connection between these units. However, this is not necessarily inconsistent with the literature. Wong and others (2014) found evidence for connections between the Upper Trinity and Edwards hydrostratigraphic units, but noted that there was no probable connection between the Middle Trinity and Edwards hydrostratigraphic unit. The limited spatial coverage of appropriate well pairs with long-term measurements make it difficult to reach significant

Conceptual Model Report for the Hill Country Trinity Aquifer
Groundwater Availability Model

conclusions regarding lateral flow between the Edwards and Trinity hydrostratigraphic units along the northern boundary of the Edwards (Balcones Fault Zone) region.

Conceptual Model Report for the Hill Country Trinity Aquifer
Groundwater Availability Model

Table 4.2.1 Number of wells with water-level data and number of water-level measurements by hydrostratigraphic unit by groundwater region (as defined in Figure 4.2.1).

Formation	Groundwater Region	Number of Wells with Water-Level Data	Number of Water-Level Measurements
Edwards	Hill Country Trinity	18	139
	Edwards-Trinity (Plateau)	1,992	8,887
	Edwards (Balcones Fault Zone)	2,165	93,057
	TOTAL	4,175	102,083
Upper Trinity	Hill Country Trinity	28	31
	Edwards-Trinity (Plateau)	503	1,475
	Edwards (Balcones Fault Zone)	613	661
	TOTAL	1,144	2,167
Middle Trinity	Hill Country Trinity	6,466	41,945
	Edwards-Trinity (Plateau)	887	3,198
	Edwards (Balcones Fault Zone)	933	2,610
	TOTAL	8,286	47,753
Lower Trinity	Hill Country Trinity	2,422	7,654
	Edwards-Trinity (Plateau)	32	517
	Edwards (Balcones Fault Zone)	207	497
	TOTAL	2,661	8,668

Conceptual Model Report for the Hill Country Trinity Aquifer
Groundwater Availability Model

Table 4.2.2 Number of wells with water-level elevation measurements in each hydrostratigraphic unit by decade.

Hydrostratigraphic unit	Number of wells by decade									
	Pre-1930	1930s	1940s	1950s	1960s	1970s	1980s	1990s	2000s	2010s
Edwards	15	184	138	673	451	357	272	247	1,723	1,147
Upper Trinity	0	4	1	53	61	24	19	30	642	361
Middle Trinity	1	64	103	96	426	343	345	451	4,517	2,639
Lower Trinity	1	6	3	25	46	82	48	70	1,430	1,085

Table 4.2.3 Number of water-level measurements in each hydrostratigraphic unit by decade.

Hydrostratigraphic unit	Number of water-level elevation measurements by decade									
	Pre-1930	1930s	1940s	1950s	1960s	1970s	1980s	1990s	2000s	2010s
Edwards	17	2,144	3,867	11,489	14,026	13,979	12,455	11,318	18,696	14,092
Upper Trinity	0	5	2	67	205	253	80	77	729	749
Middle Trinity	1	64	106	137	535	657	1,290	7,081	20,952	16,930
Lower Trinity	1	18	30	28	91	169	144	357	3,889	3,941

Table 4.2.4 Number of water-level targets for the transient model in each hydrostratigraphic unit by groundwater region (as defined in Figure 4.2.1) and by decade.

Hydrostratigraphic Unit	Region	Well with at least 10 water-level elevations over at least 10 years
Edwards	Hill Country Trinity	0
	Edwards-Trinity (Plateau)	36
	Edwards (Balcones Fault Zone)	195
	TOTAL	231
Upper Trinity	Hill Country Trinity	0
	Edwards-Trinity (Plateau)	7
	Edwards (Balcones Fault Zone)	1
	TOTAL	8
Middle Trinity	Hill Country Trinity	151
	Edwards-Trinity (Plateau)	14
	Edwards (Balcones Fault Zone)	3
	TOTAL	168
Lower Trinity	Hill Country Trinity	29
	Edwards-Trinity (Plateau)	0
	Edwards (Balcones Fault Zone)	2
	TOTAL	31

Conceptual Model Report for the Hill Country Trinity Aquifer
Groundwater Availability Model

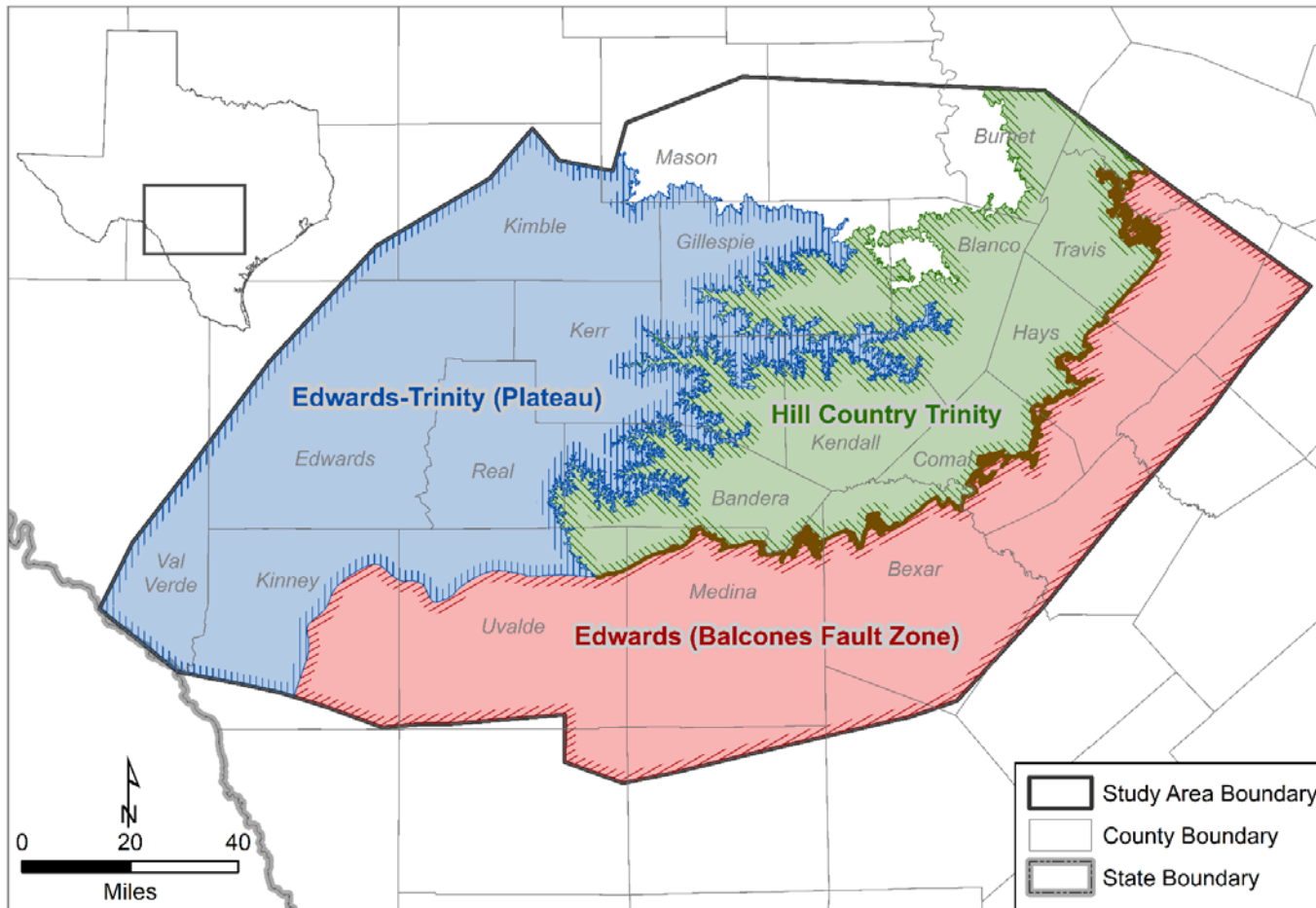

Groundwater regions in the current study area



Figure 4.2.1 Groundwater regions in the current study area.

Conceptual Model Report for the Hill Country Trinity Aquifer
Groundwater Availability Model

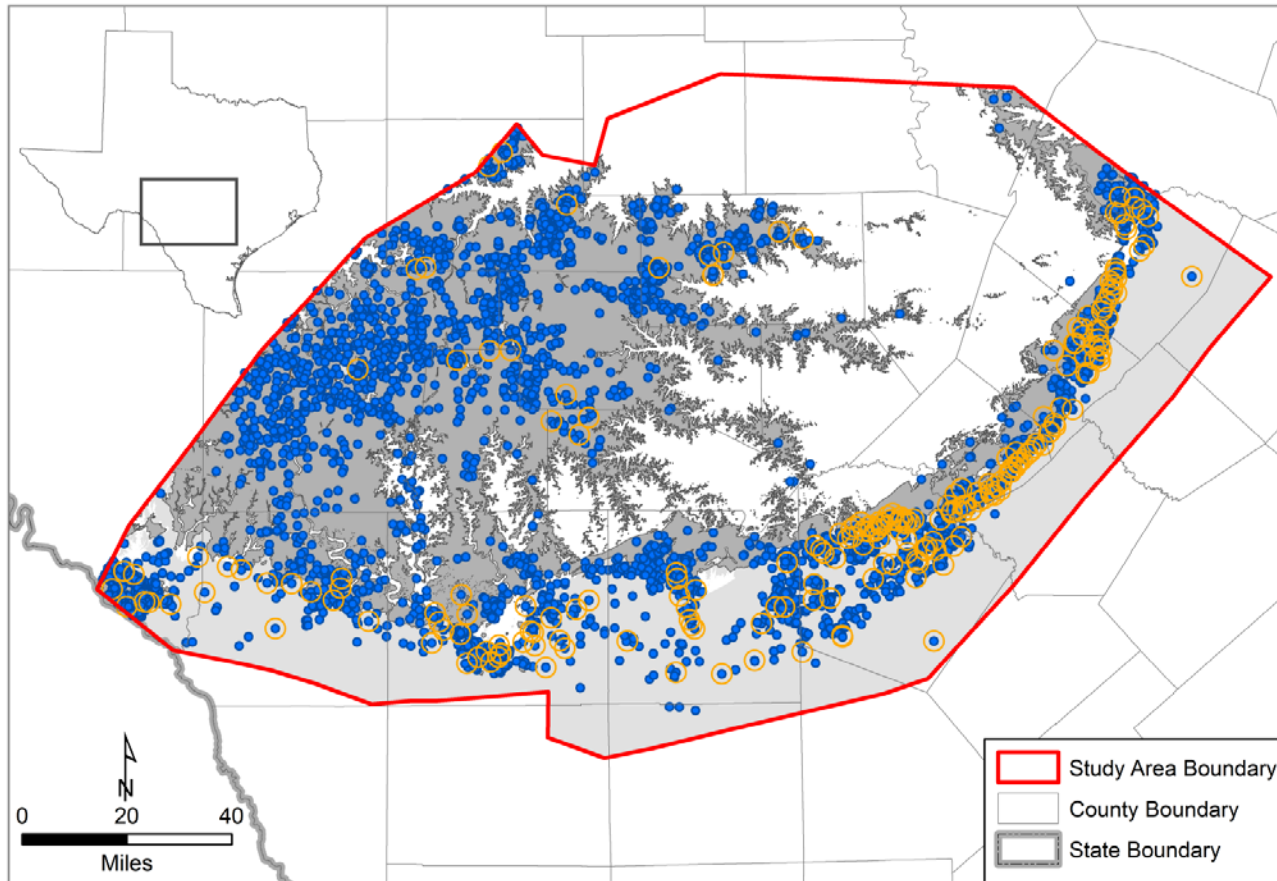

Water Level Wells in the Edwards Hydrostratigraphic Unit

- Well with water level
- Well with at least 10 water levels over at least 10 years
- Outcrop
- Subcrop

Figure 4.2.2 Spatial distribution of wells with water-level elevation measurements in the Edwards hydrostratigraphic unit.

Conceptual Model Report for the Hill Country Trinity Aquifer
Groundwater Availability Model

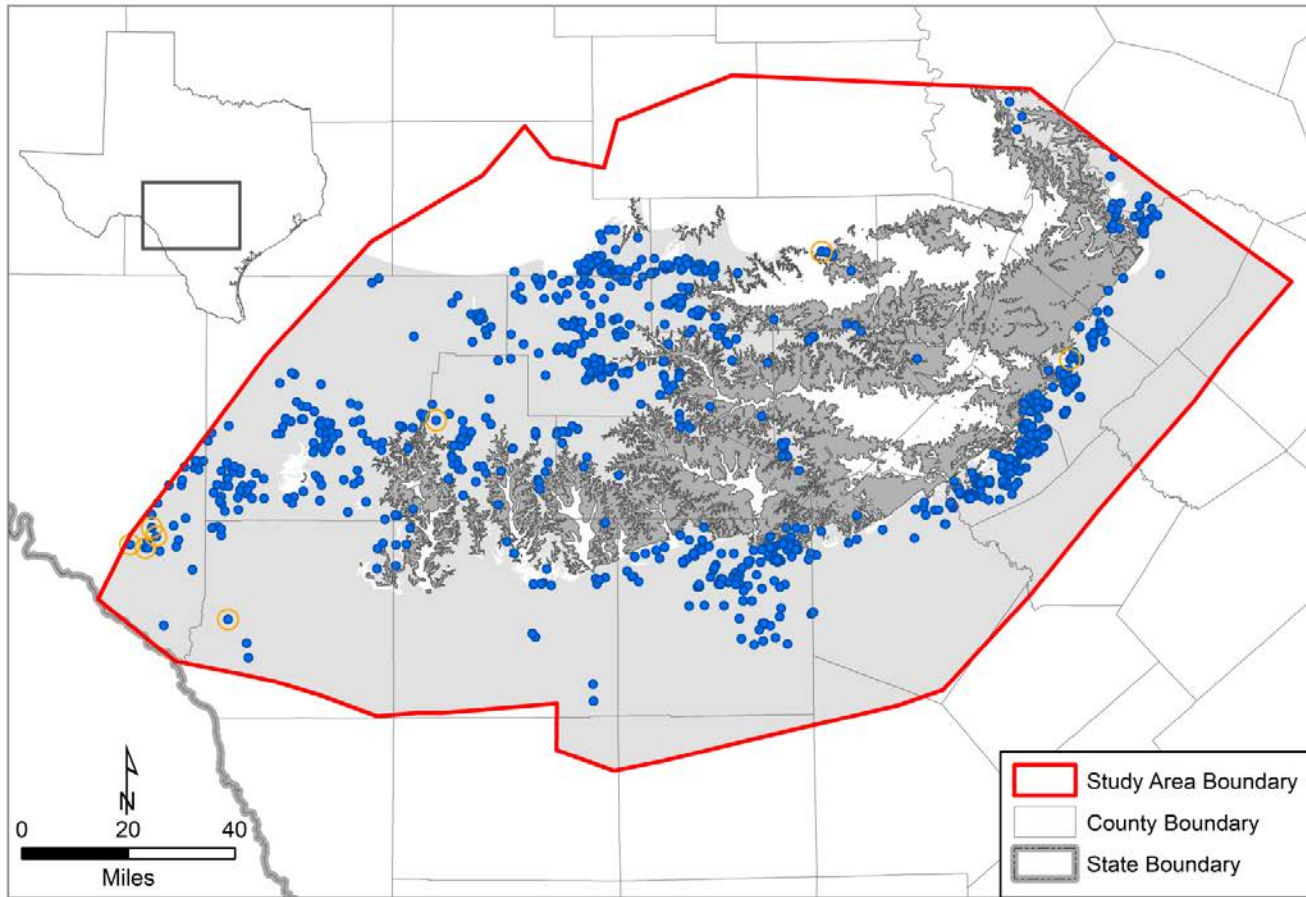

Water Level Wells in the Upper Trinity Hydrostratigraphic Unit

- Well with water level
- Well with at least 10 water levels over at least 10 years
- Outcrop
- Subcrop

Figure 4.2.3 Spatial distribution of wells with water-level elevation measurements in the Upper Trinity hydrostratigraphic unit.

Conceptual Model Report for the Hill Country Trinity Aquifer
Groundwater Availability Model

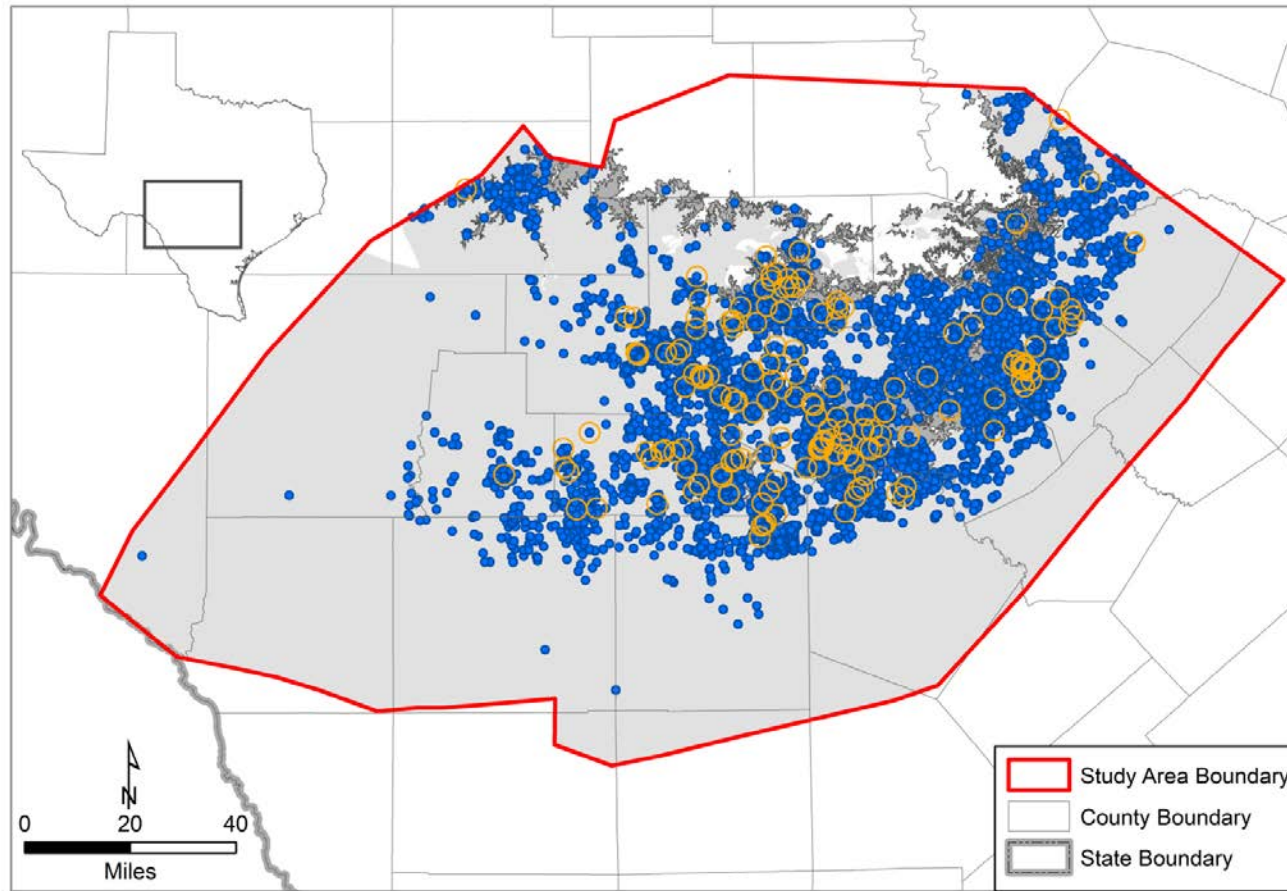

Water Level Wells in the Middle Trinity Hydrostratigraphic Unit

- Well with water level
- Well with at least 10 water levels over at least 10 years
- Outcrop
- Subcrop

Figure 4.2.4 Spatial distribution of wells with water-level elevation measurements in the Middle Trinity hydrostratigraphic unit.

Conceptual Model Report for the Hill Country Trinity Aquifer
Groundwater Availability Model

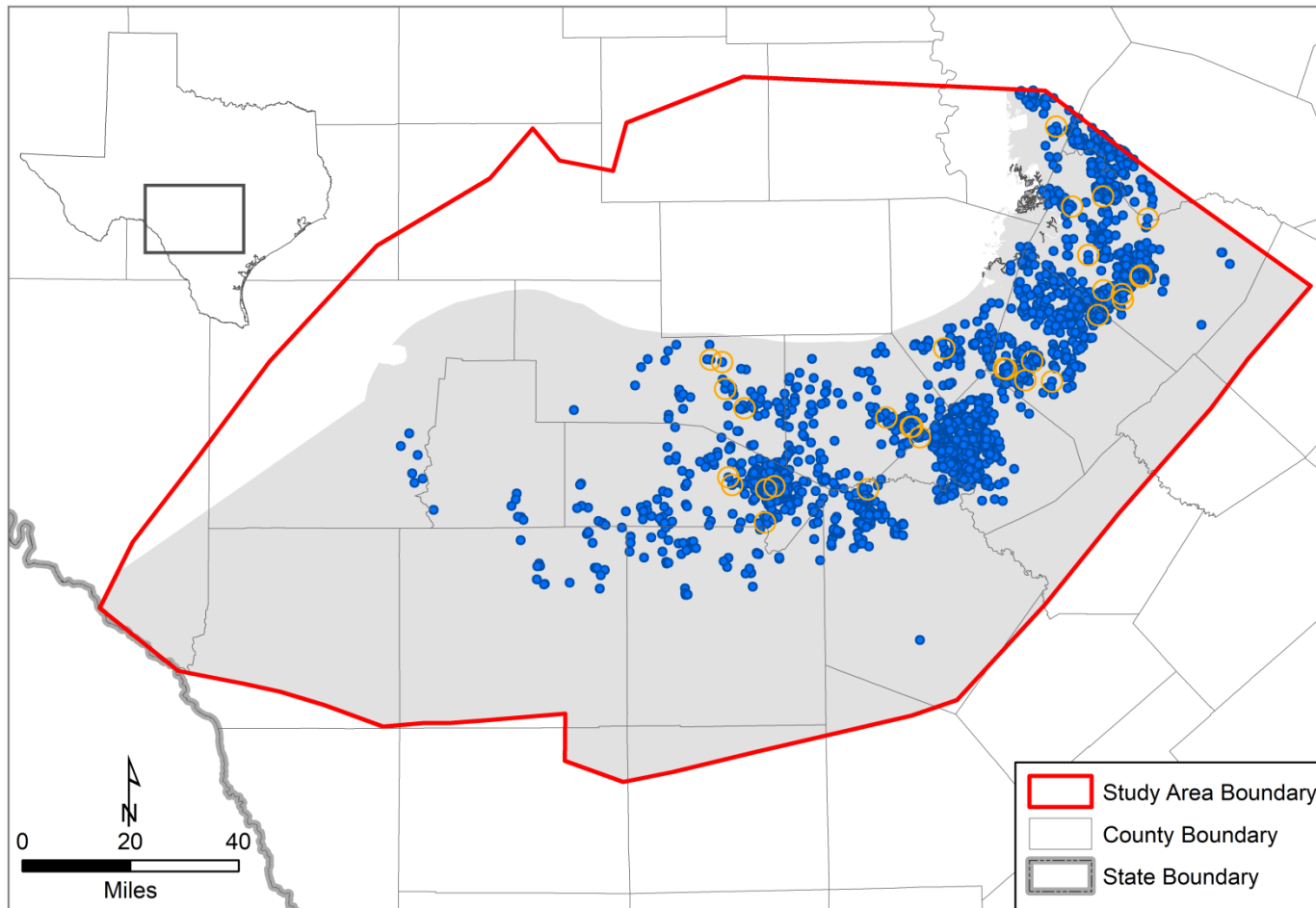

Water Level Wells in the Lower Trinity Hydrostratigraphic Unit

- Well with water level
- Well with at least 10 water levels over at least 10 years
- Outcrop
- Subcrop

Figure 4.2.5 Spatial distribution of wells with water-level elevation measurements in the Lower Trinity hydrostratigraphic unit.

Conceptual Model Report for the Hill Country Trinity Aquifer Groundwater Availability Model

(a)

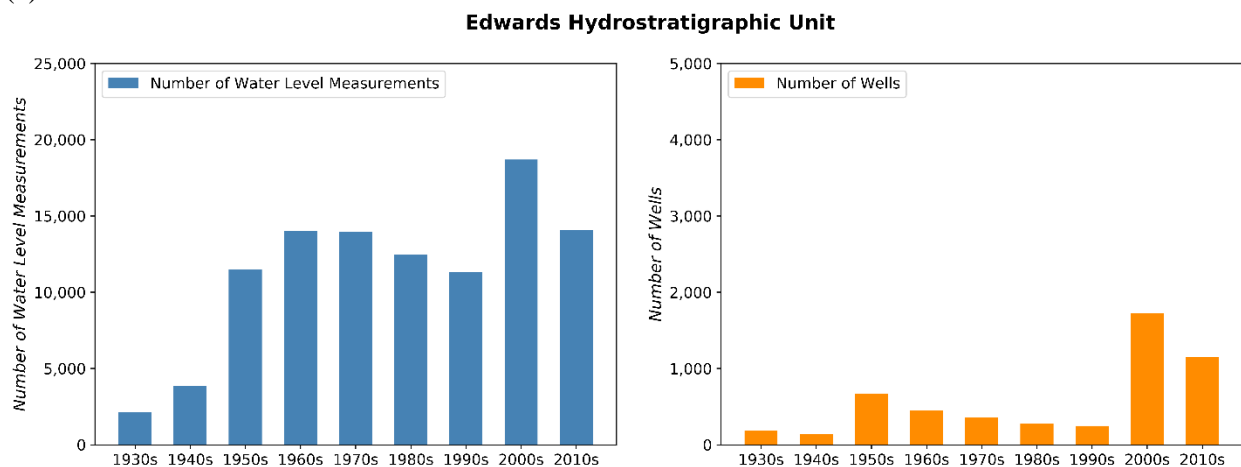

(b)

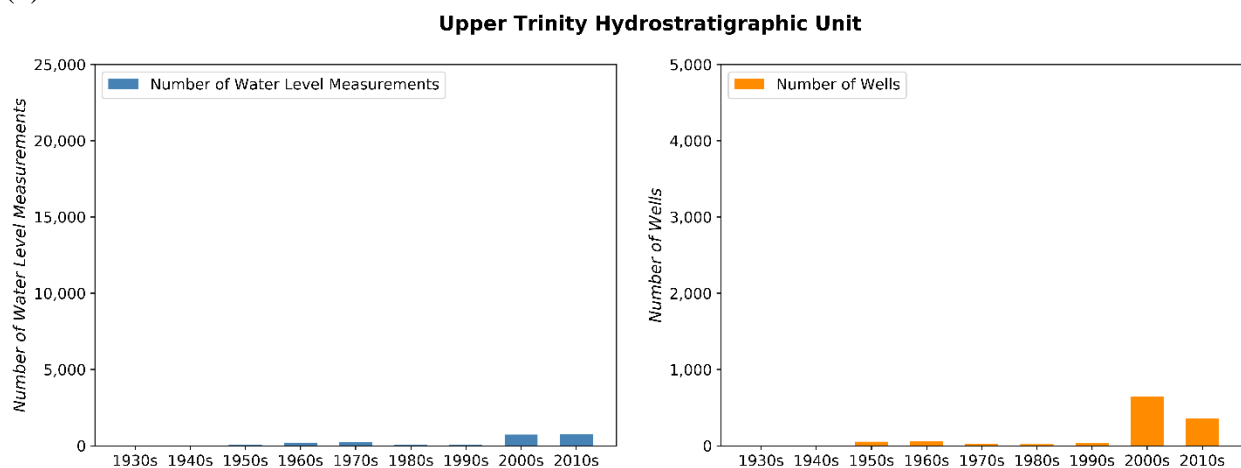
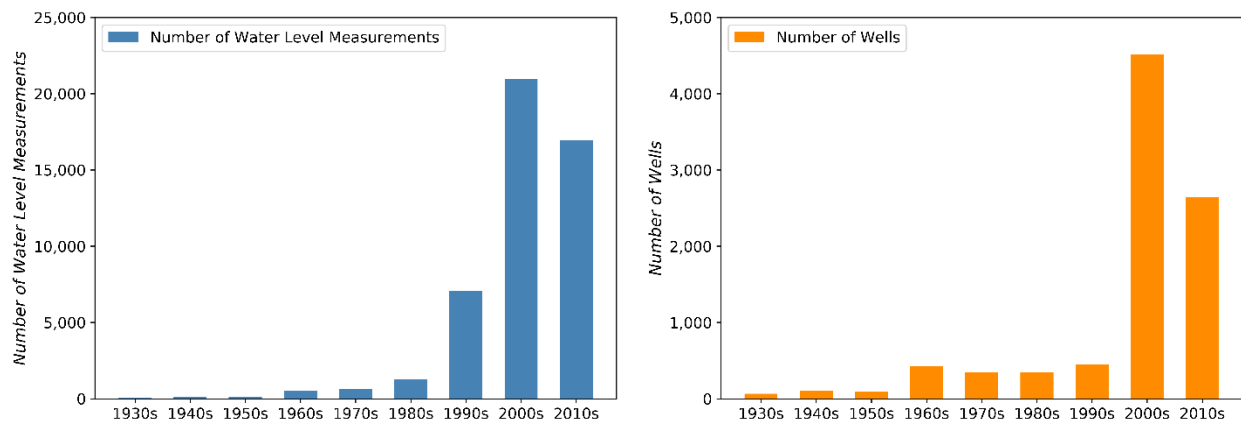

Figure 4.2.6 Temporal distribution of water-level measurements in the a) Edwards hydrostratigraphic unit and b) Upper Trinity hydrostratigraphic unit.

Conceptual Model Report for the Hill Country Trinity Aquifer
Groundwater Availability Model

(a)

Middle Trinity Hydrostratigraphic Unit



(b)

Lower Trinity Hydrostratigraphic Unit

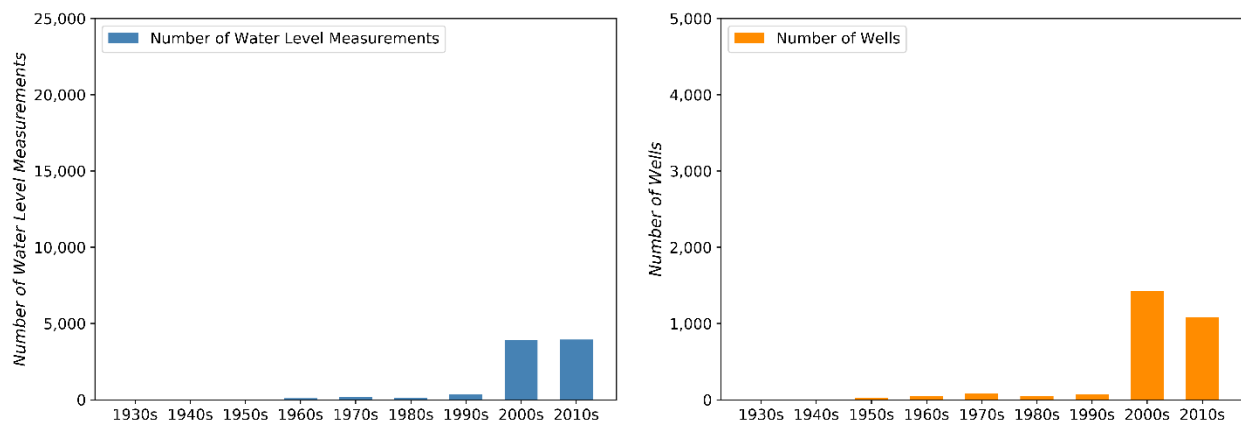
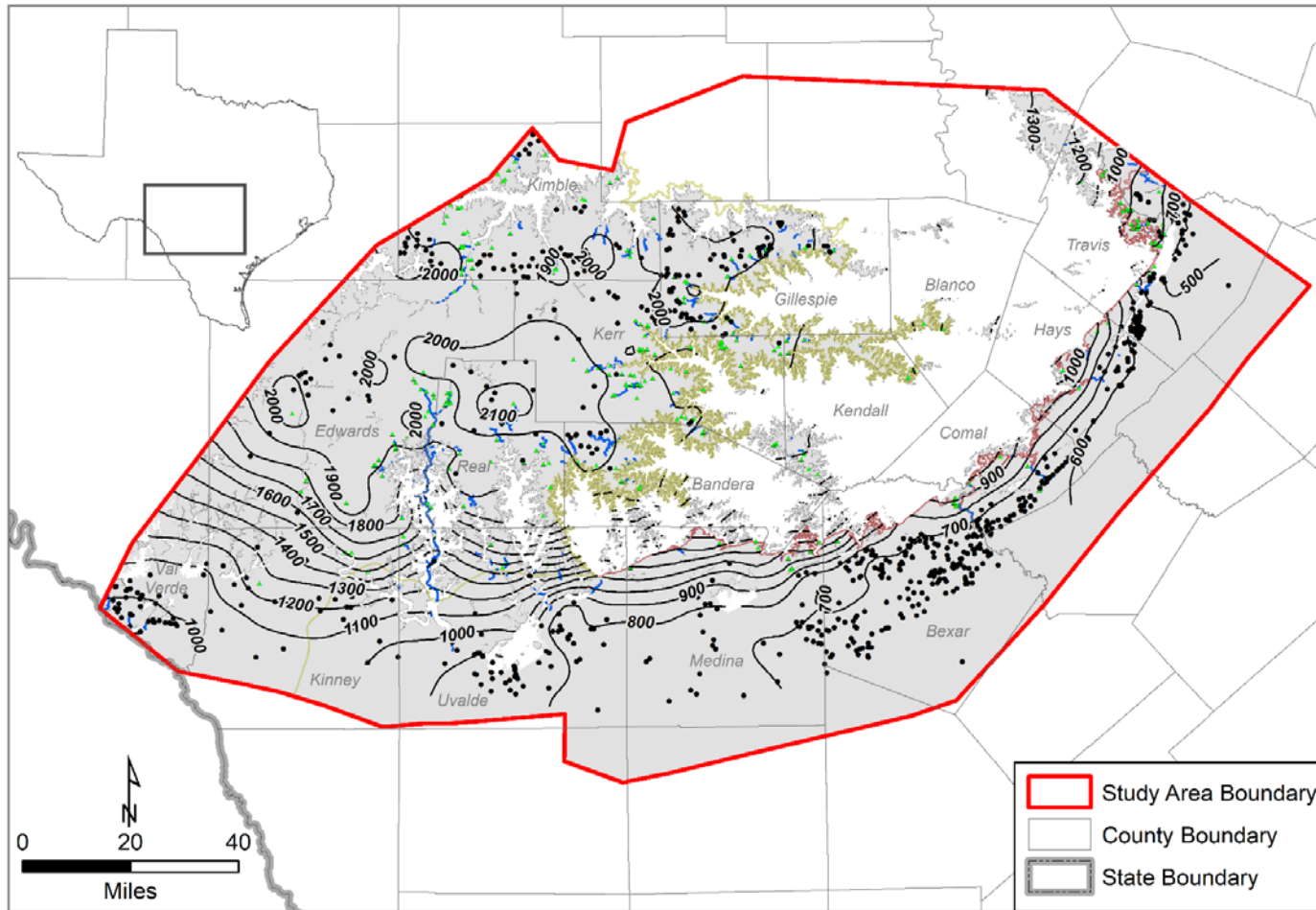

Figure 4.2.7 Temporal distribution of water-level measurements in the a) Middle Trinity hydrostratigraphic unit and b) Lower Trinity hydrostratigraphic unit.

Conceptual Model Report for the Hill Country Trinity Aquifer
Groundwater Availability Model



Water Level Elevation (feet) in the Edwards Hydrostratigraphic Unit - Pre-development

- | | | |
|---------------------|---------------------------|---|
| Water Level Contour | Water Level Control Point | Edwards (Balcones Fault Zone) region boundary |
| Outcrop | Spring | Edwards-Trinity (Plateau) region boundary |
| Subcrop | Perennial Stream Point | |

Figure 4.2.8 Estimated pre-development water-level elevation contours in feet above mean sea level for the Edwards hydrostratigraphic unit.

Conceptual Model Report for the Hill Country Trinity Aquifer
Groundwater Availability Model

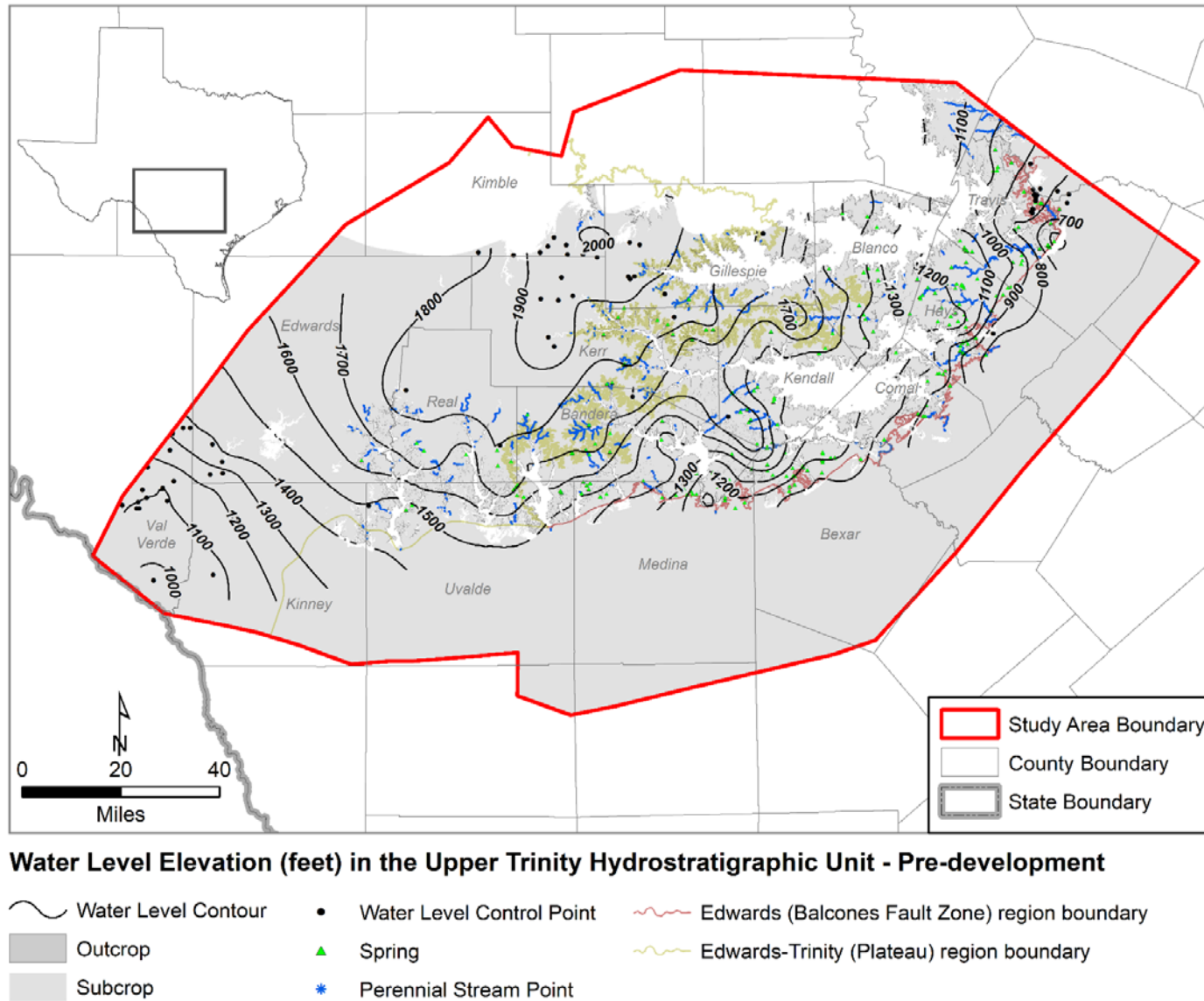
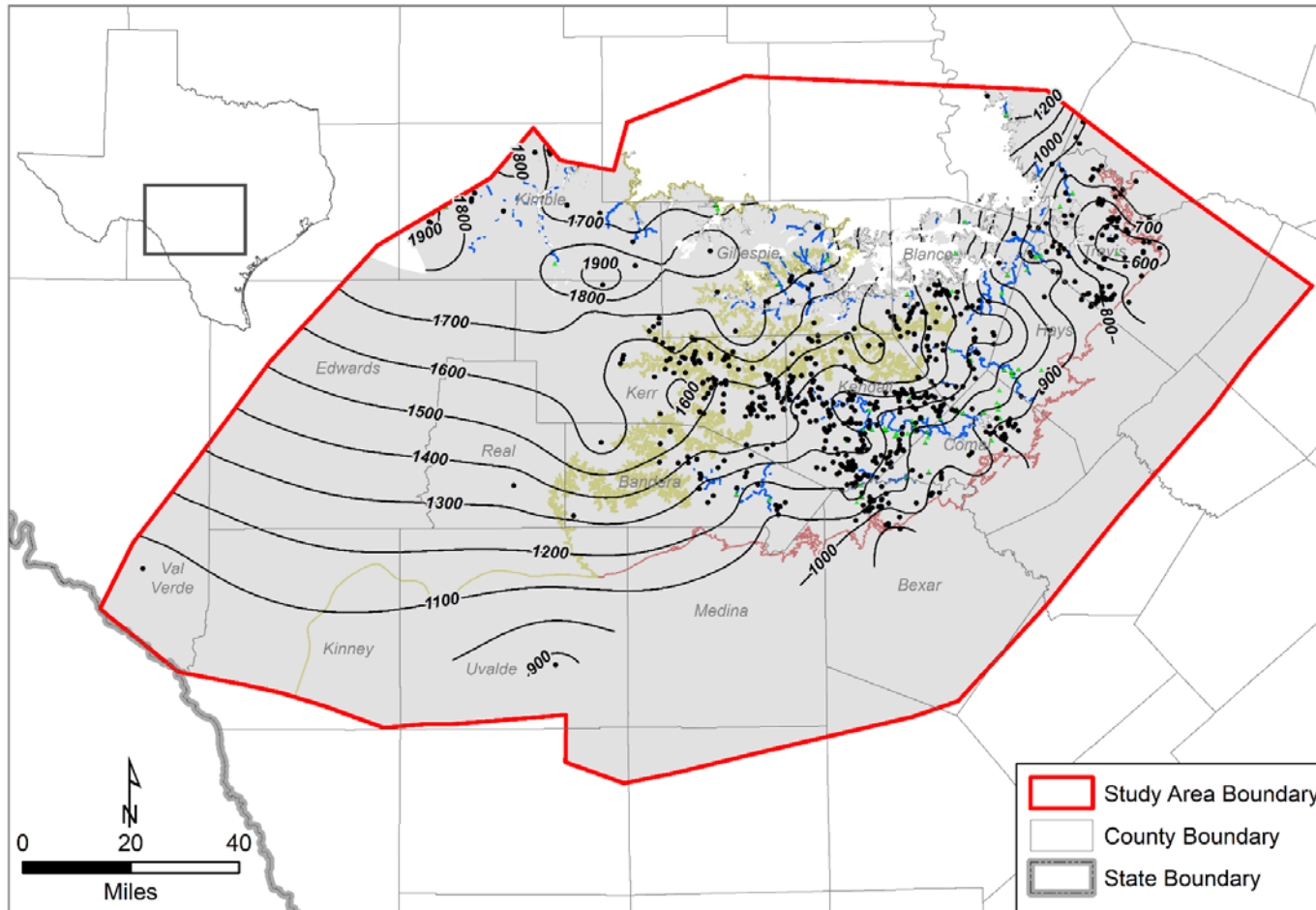

Figure 4.2.9 Estimated pre-development water-level elevation contours in feet above mean sea level for the Upper Trinity hydrostratigraphic unit.

Conceptual Model Report for the Hill Country Trinity Aquifer
Groundwater Availability Model



Water Level Elevation (feet) in the Middle Trinity Hydrostratigraphic Unit - Pre-development

- Water Level Contour
- Outcrop
- Subcrop
- Water Level Control Point
- Spring
- Perennial Stream Point
- Edwards (Balcones Fault Zone) region boundary
- Edwards-Trinity (Plateau) region boundary

Figure 4.2.10 Estimated pre-development water-level elevation contours in feet above mean sea level for the Middle Trinity hydrostratigraphic unit.

Conceptual Model Report for the Hill Country Trinity Aquifer
Groundwater Availability Model

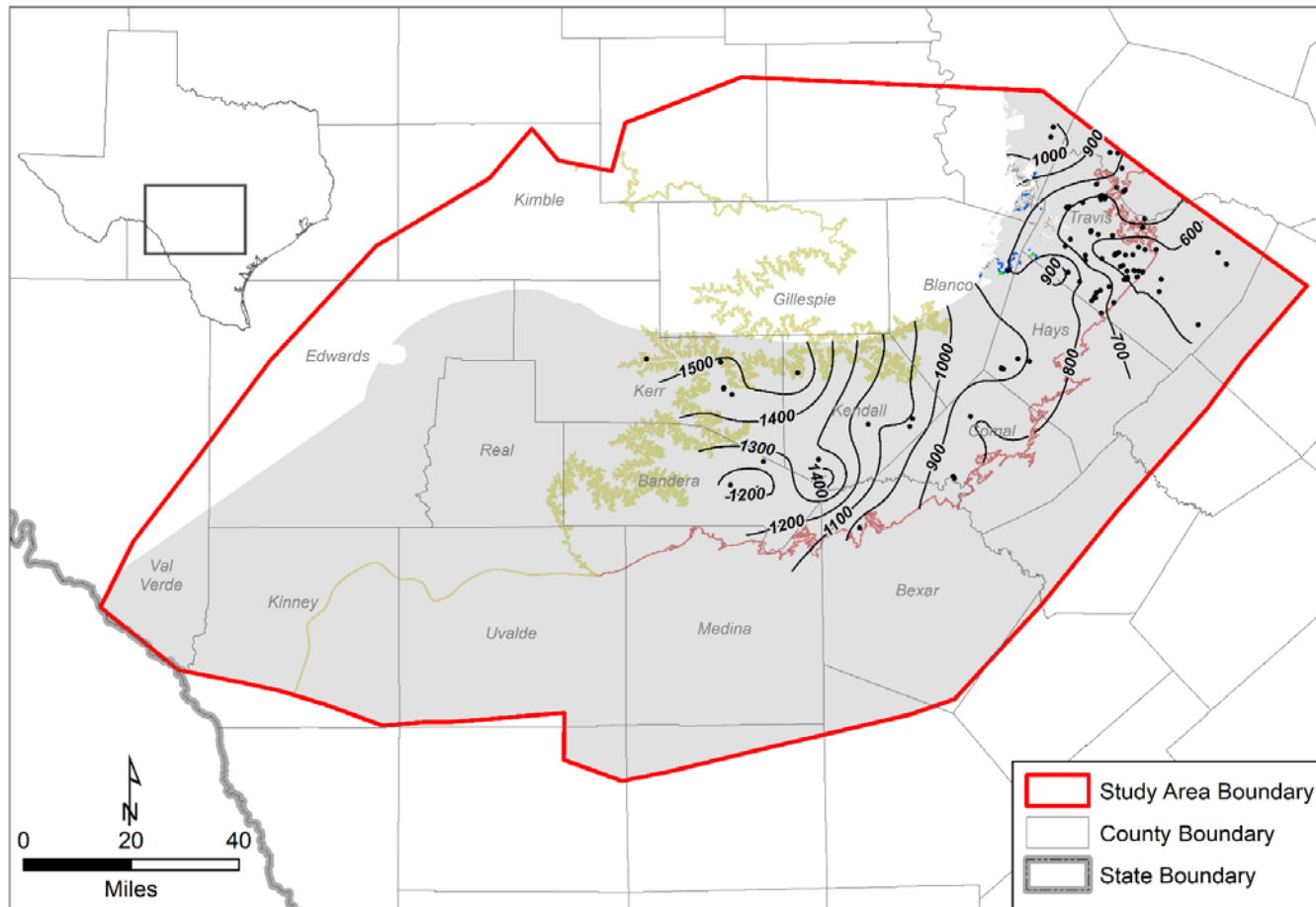

Water Level Elevation (feet) in the Lower Trinity Hydrostratigraphic Unit - Pre-development

- Water Level Contour
 Water Level Control Point
 Edwards (Balcones Fault Zone) region boundary
- Outcrop
 Spring
 Edwards-Trinity (Plateau) region boundary
- Subcrop
 Perennial Stream Point

Figure 4.2.11 Estimated pre-development water-level elevation contours in feet above mean sea level for the Lower Trinity hydrostratigraphic unit.

Conceptual Model Report for the Hill Country Trinity Aquifer
Groundwater Availability Model

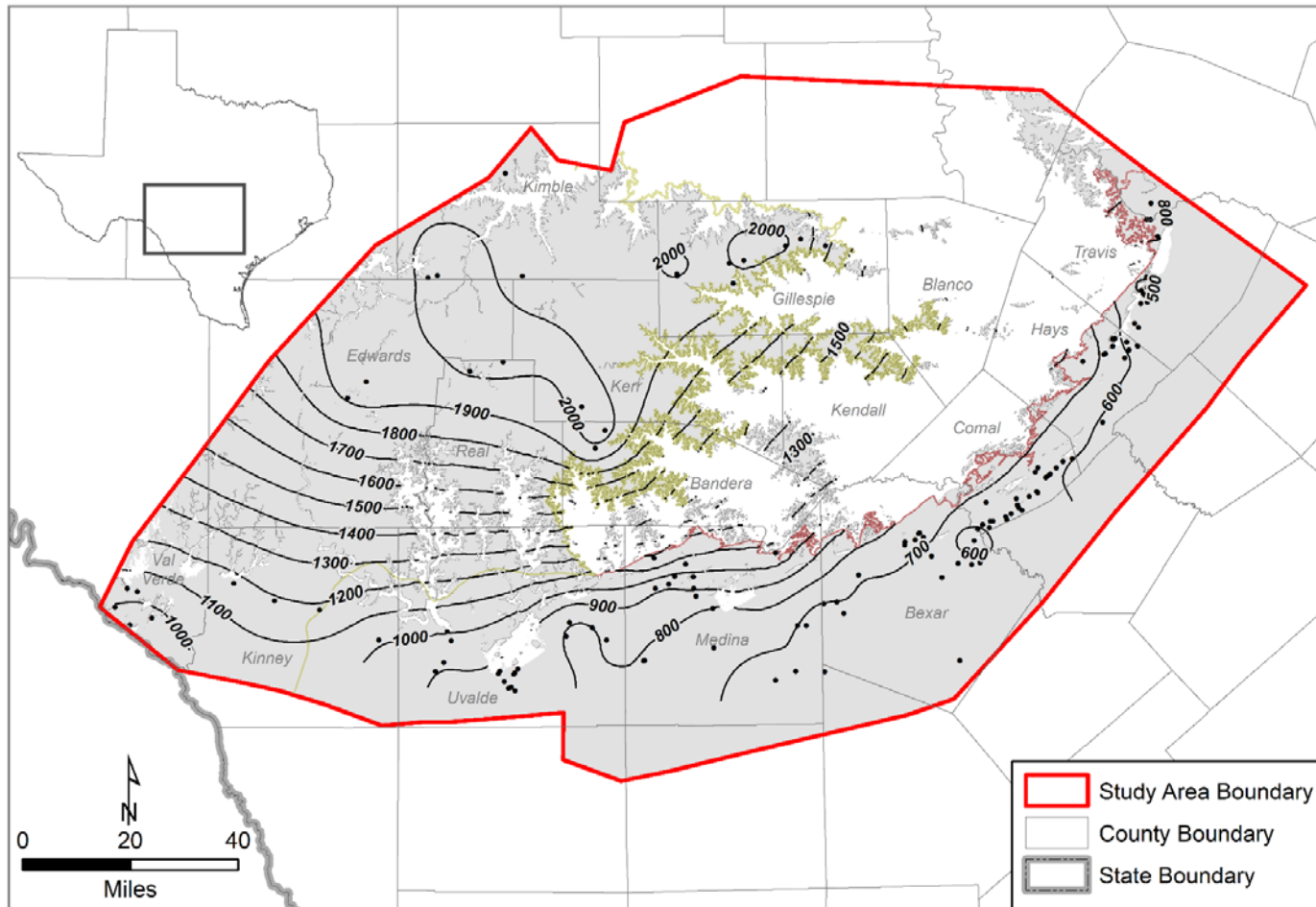

Water Level Elevation (feet) in the Edwards Hydrostratigraphic Unit - 1990

- Water Level Contour
 Water Level Control Point
 Edwards (Balcones Fault Zone) region boundary
- Outcrop
 Spring
 Edwards-Trinity (Plateau) region boundary
- Subcrop
 Perennial Stream Point

Figure 4.2.12 Estimated water-level elevation contours in feet above mean sea level in the Edwards hydrostratigraphic unit in 1990.

Conceptual Model Report for the Hill Country Trinity Aquifer
Groundwater Availability Model

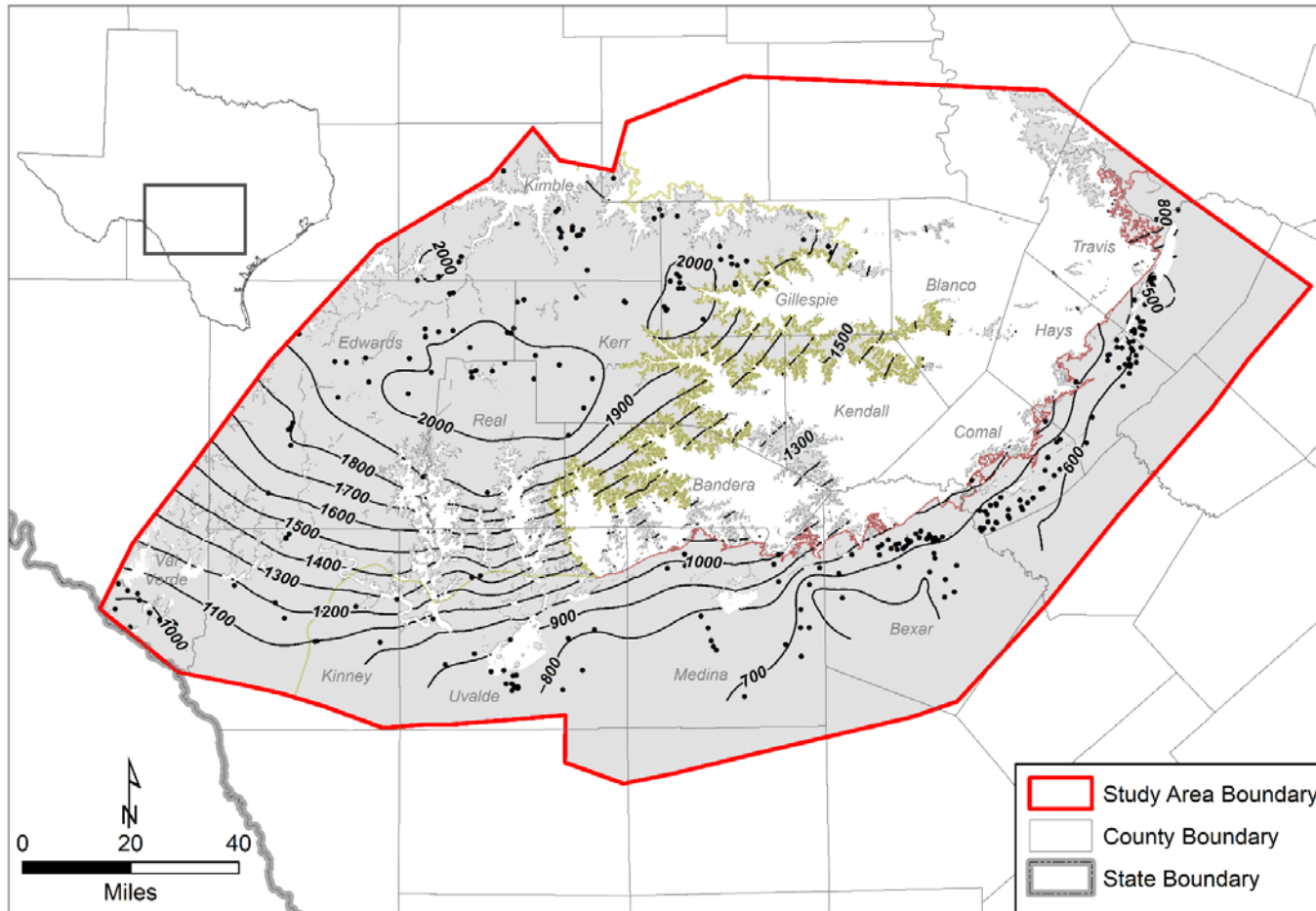

Water Level Elevation (feet) in the Edwards Hydrostratigraphic Unit - 2000

- | | | |
|---------------------|---------------------------|---|
| Water Level Contour | Water Level Control Point | Edwards (Balcones Fault Zone) region boundary |
| Outcrop | Spring | Edwards-Trinity (Plateau) region boundary |
| Subcrop | Perennial Stream Point | |

Figure 4.2.13 Estimated water-level elevation contours in feet above mean sea level in the Edwards hydrostratigraphic unit in 2000.

Conceptual Model Report for the Hill Country Trinity Aquifer
Groundwater Availability Model

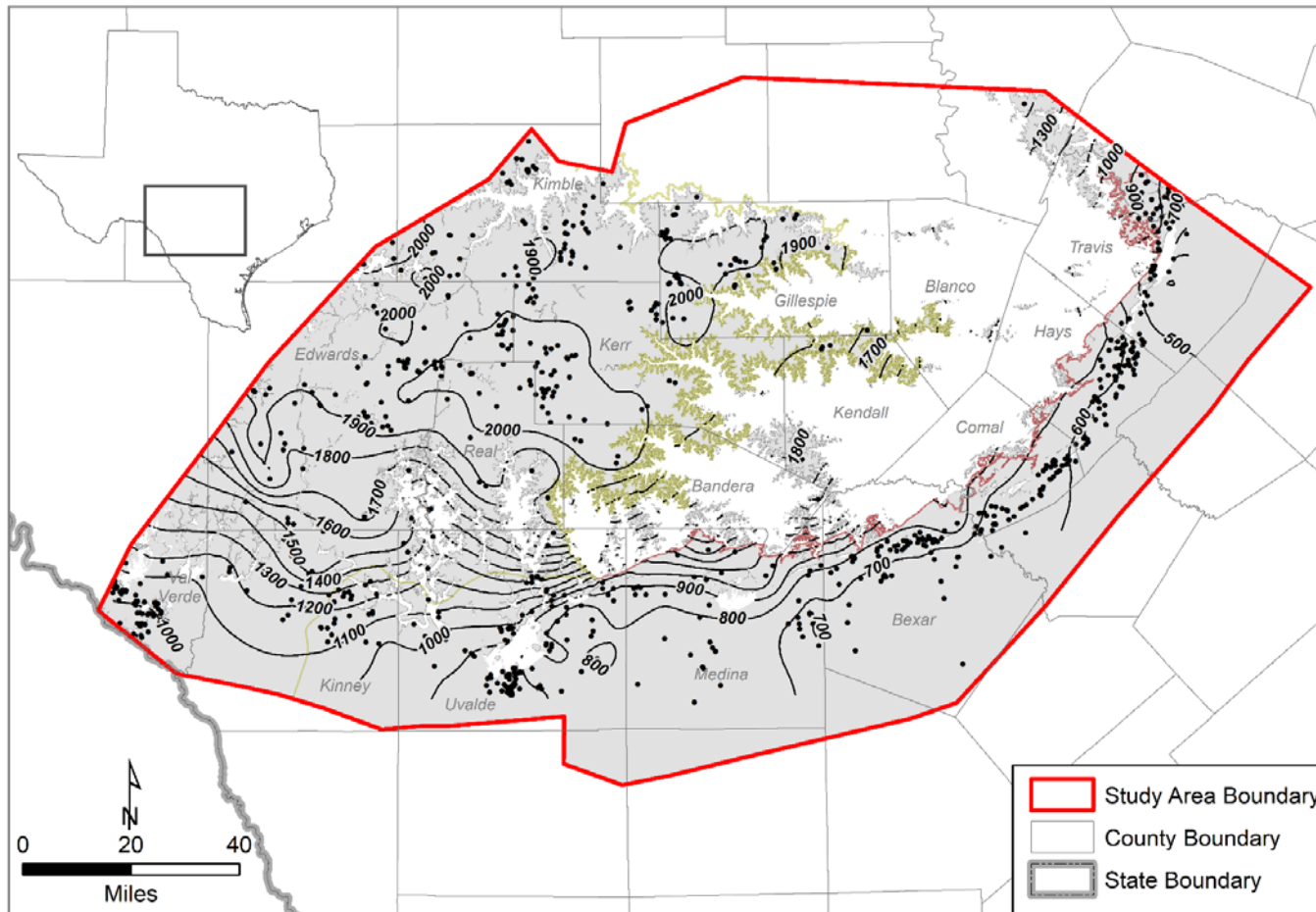

Water Level Elevation (feet) in the Edwards Hydrostratigraphic Unit - 2010

- ~ Water Level Contour
- Water Level Control Point
- ~ Edwards (Balcones Fault Zone) region boundary
- Outcrop
- ▲ Spring
- ~ Edwards-Trinity (Plateau) region boundary
- Subcrop
- * Perennial Stream Point

Figure 4.2.14 Estimated water-level elevation contours in feet above mean sea level in the Edwards hydrostratigraphic unit in 2010.

Conceptual Model Report for the Hill Country Trinity Aquifer
Groundwater Availability Model

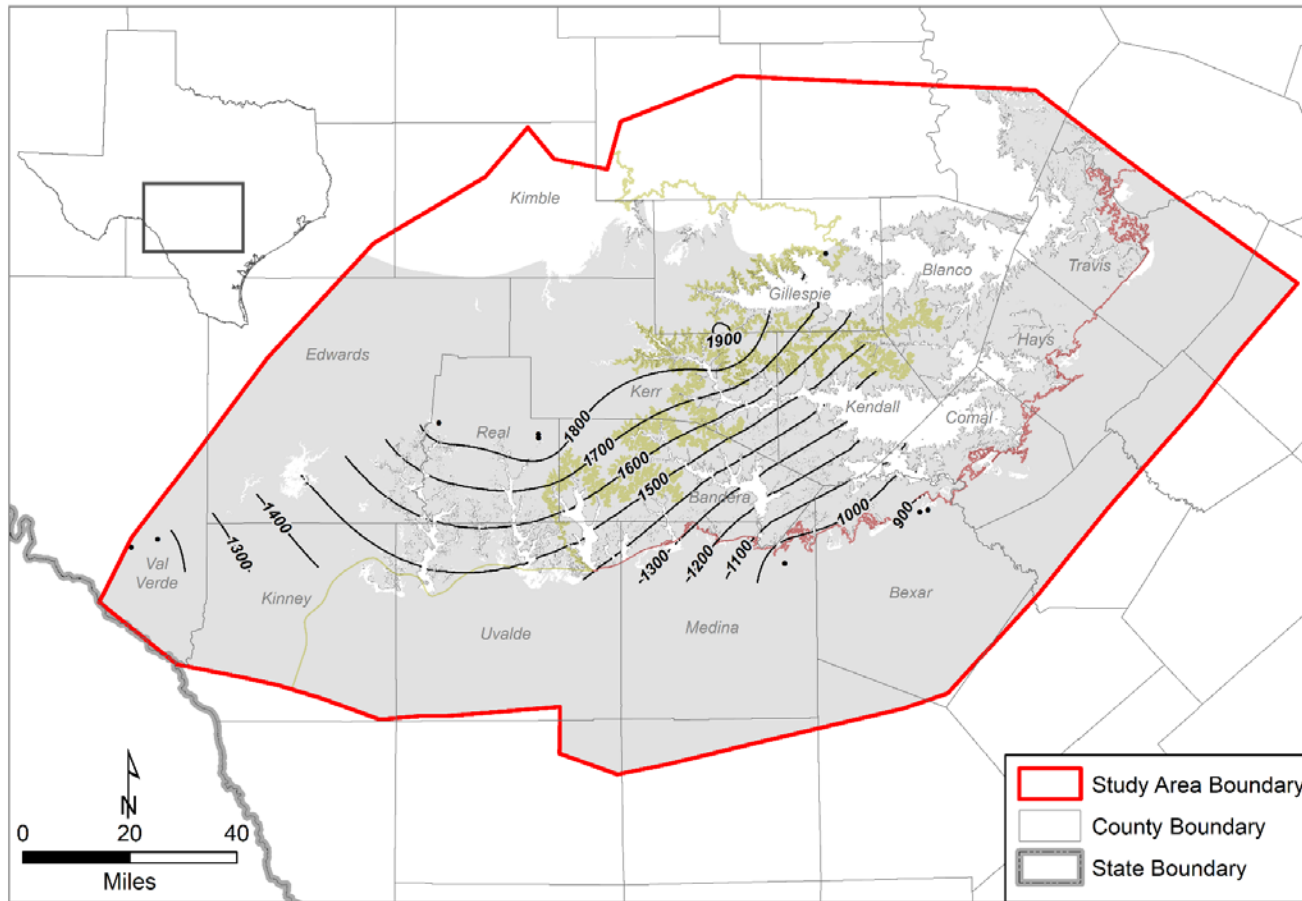

Water Level Elevation (feet) in the Upper Trinity Hydrostratigraphic Unit - 1990

- | | | |
|---------------------|---------------------------|---|
| Water Level Contour | Water Level Control Point | Edwards (Balcones Fault Zone) region boundary |
| Outcrop | Spring | Edwards-Trinity (Plateau) region boundary |
| Subcrop | Perennial Stream Point | |

Figure 4.2.15 Estimated water-level elevation contours in feet above mean sea level in the Upper Trinity hydrostratigraphic unit in 1990.

Conceptual Model Report for the Hill Country Trinity Aquifer
Groundwater Availability Model

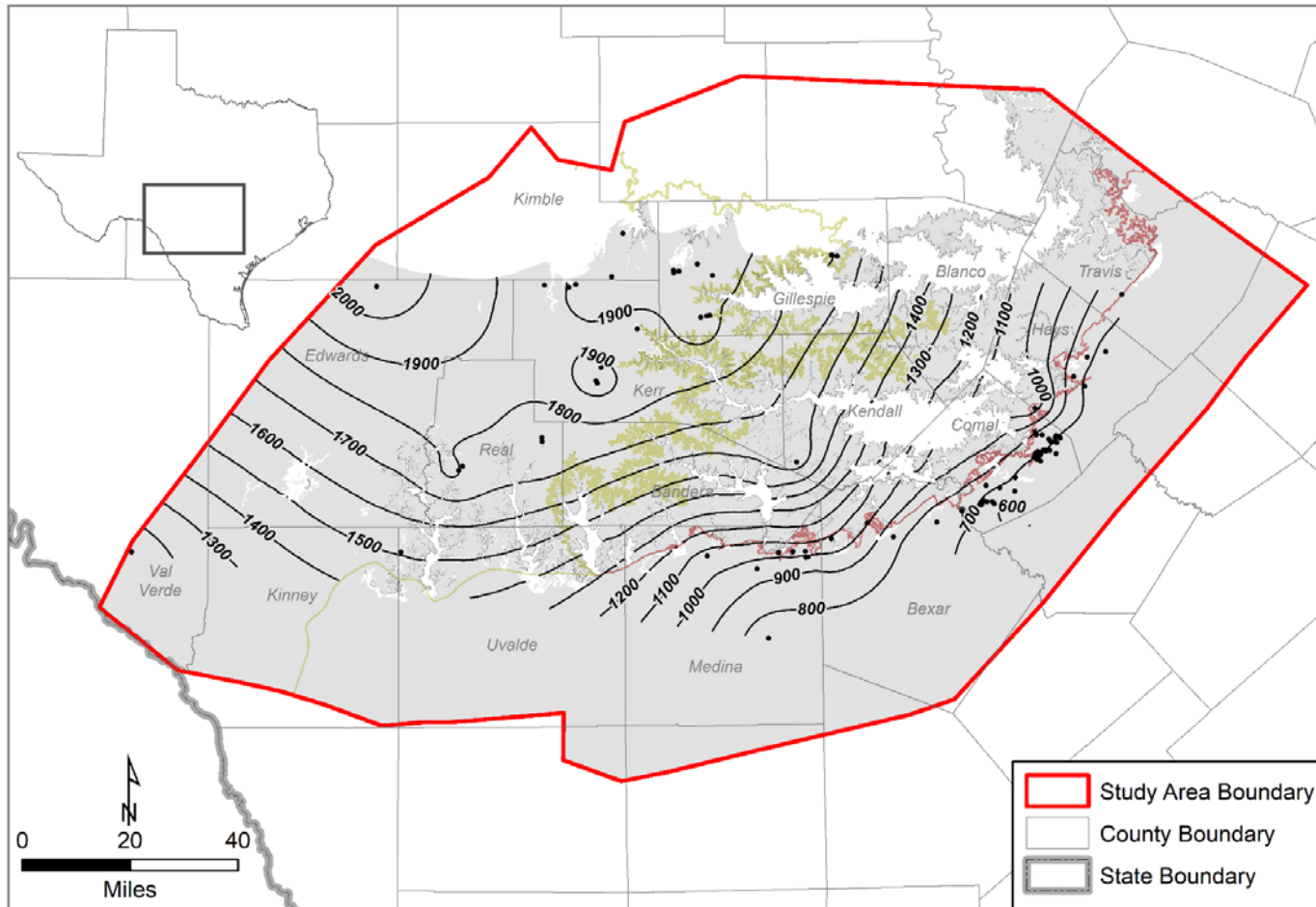

Water Level Elevation (feet) in the Upper Trinity Hydrostratigraphic Unit - 2000

- Water Level Contour
- Water Level Control Point
- Edwards (Balcones Fault Zone) region boundary
- Outcrop
- Spring
- Edwards-Trinity (Plateau) region boundary
- Subcrop
- Perennial Stream Point

Figure 4.2.16 Estimated water-level elevation contours in feet above mean sea level in the Upper Trinity hydrostratigraphic unit in 2000.

Conceptual Model Report for the Hill Country Trinity Aquifer
Groundwater Availability Model

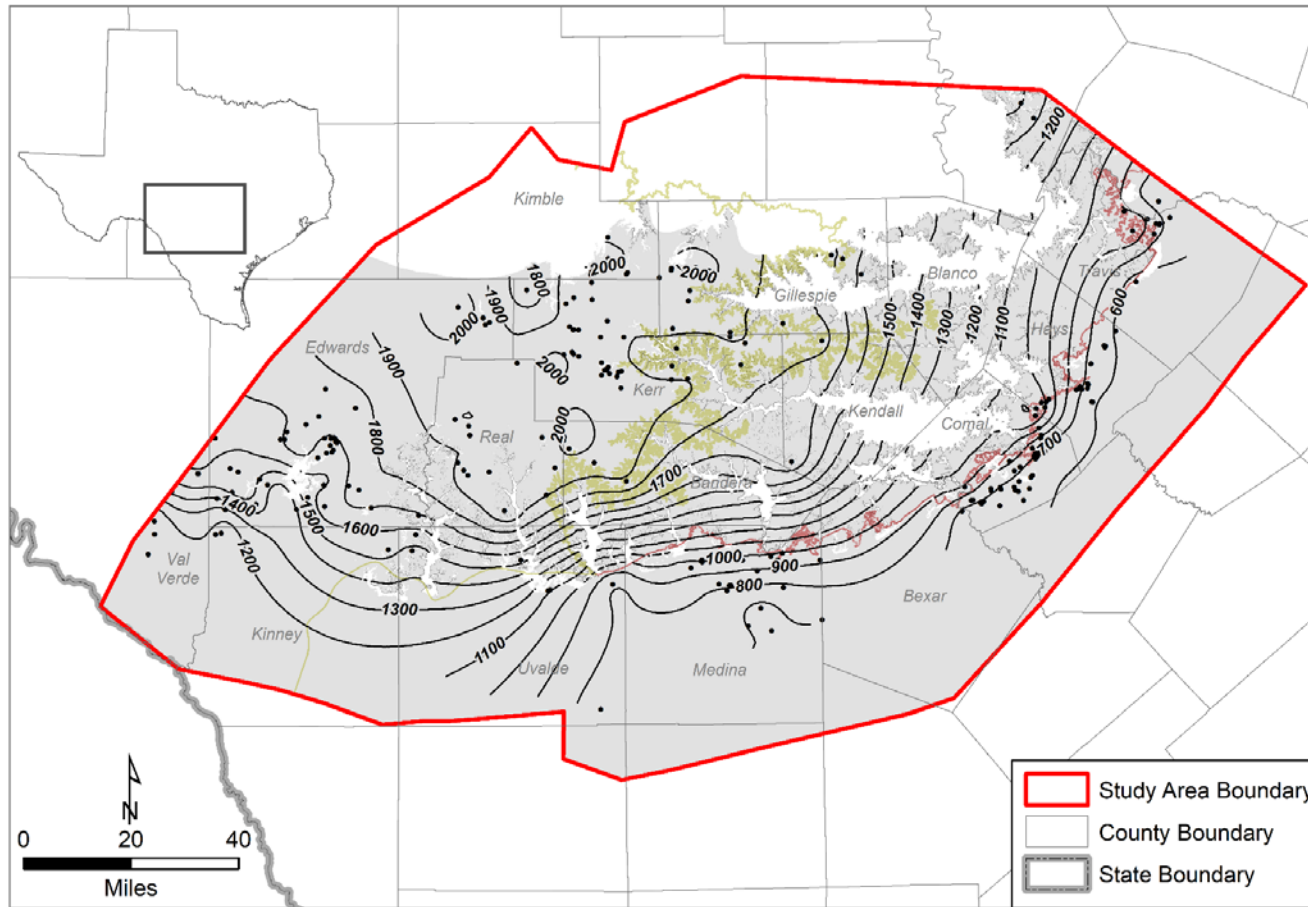

Water Level Elevation (feet) in the Upper Trinity Hydrostratigraphic Unit - 2010

- ~ Water Level Contour
- Water Level Control Point
- ~ Edwards (Balcones Fault Zone) region boundary
- Outcrop
- ▲ Spring
- ~ Edwards-Trinity (Plateau) region boundary
- Subcrop
- * Perennial Stream Point

Figure 4.2.17 Estimated water-level elevation contours in feet above mean sea level in the Upper Trinity hydrostratigraphic unit in 2010.

Conceptual Model Report for the Hill Country Trinity Aquifer
Groundwater Availability Model

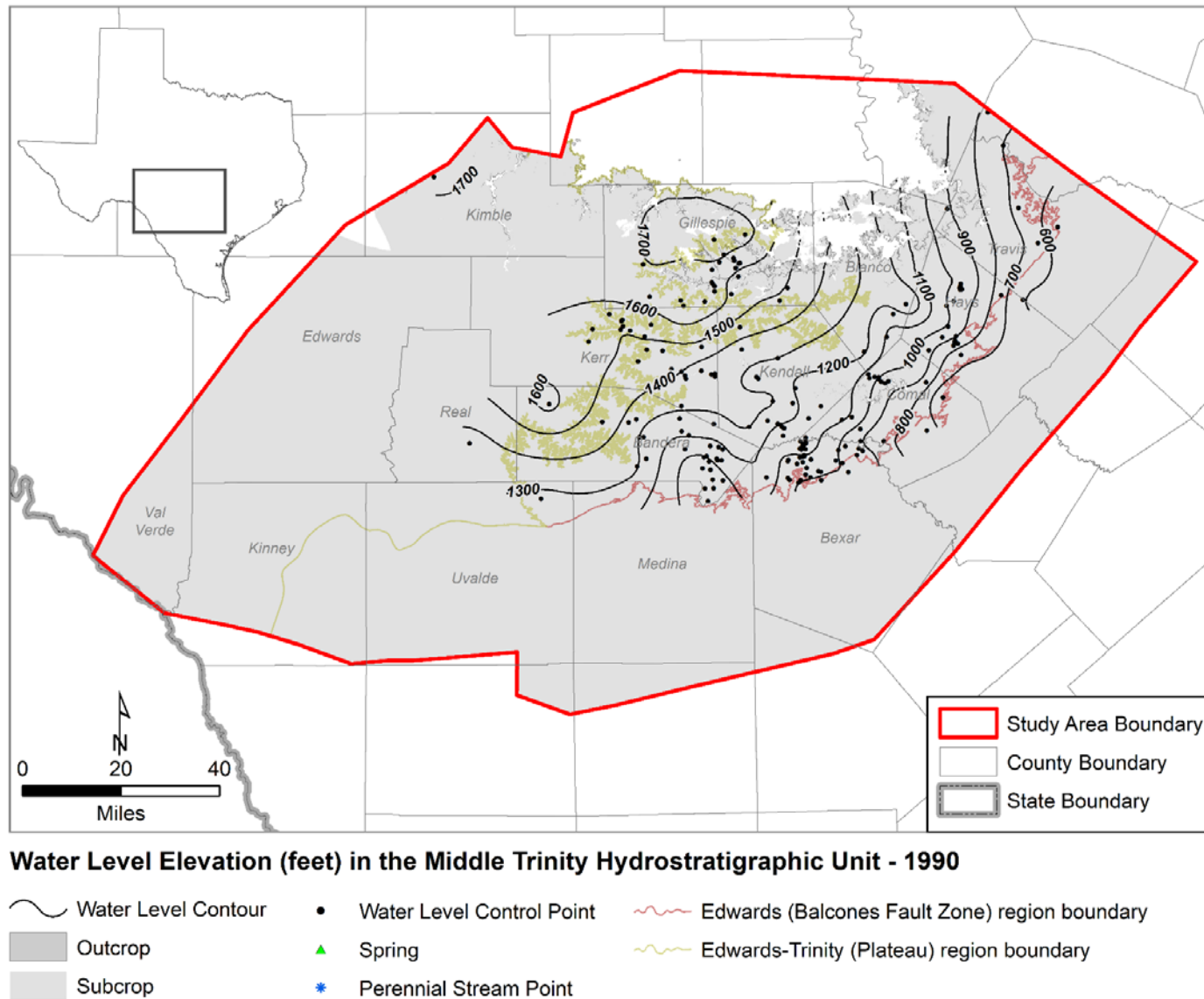
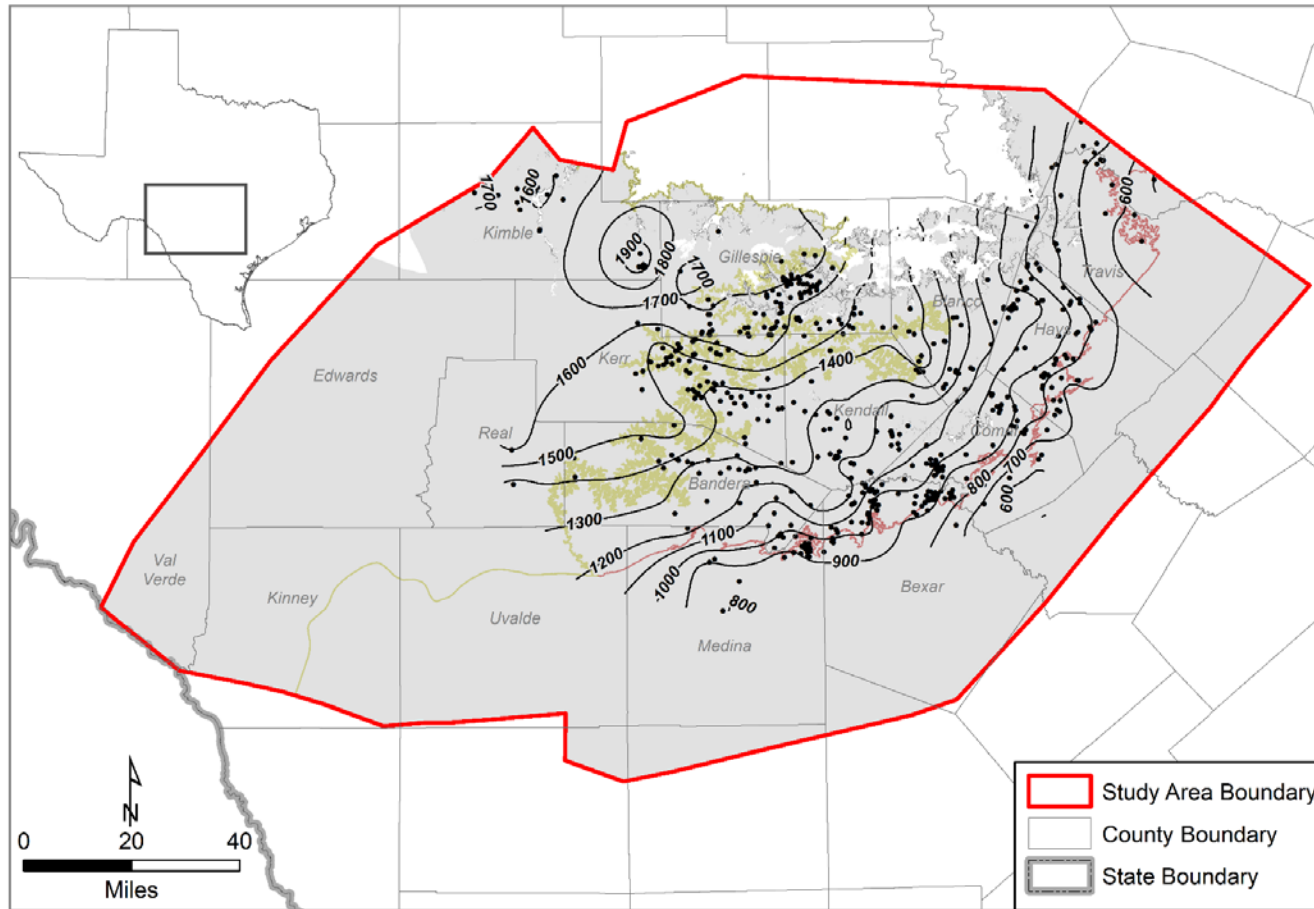

Figure 4.2.18 Estimated water-level elevation contours in feet above mean sea level in the Middle Trinity hydrostratigraphic unit in 1990.

Conceptual Model Report for the Hill Country Trinity Aquifer
Groundwater Availability Model



Water Level Elevation (feet) in the Middle Trinity Hydrostratigraphic Unit - 2000

- | | | |
|---------------------|---------------------------|---|
| Water Level Contour | Water Level Control Point | Edwards (Balcones Fault Zone) region boundary |
| Outcrop | Spring | Edwards-Trinity (Plateau) region boundary |
| Subcrop | Perennial Stream Point | |

Figure 4.2.19 Estimated water-level elevation contours in feet above mean sea level in the Middle Trinity hydrostratigraphic unit in 2000.

Conceptual Model Report for the Hill Country Trinity Aquifer
Groundwater Availability Model

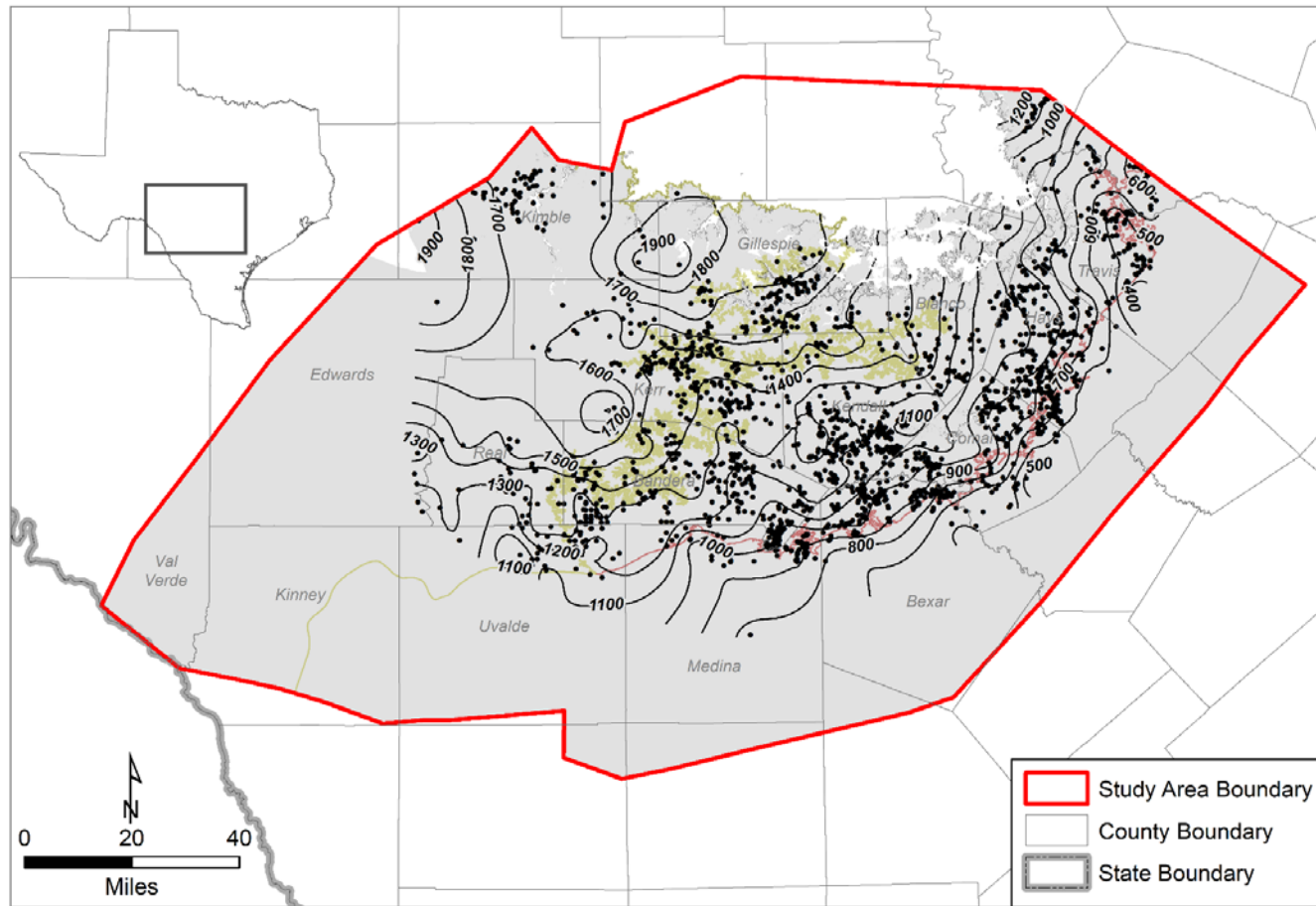

Water Level Elevation (feet) in the Middle Trinity Hydrostratigraphic Unit - 2010

- Water Level Contour
 Water Level Control Point
 Edwards (Balcones Fault Zone) region boundary
- Outcrop
 Spring
 Edwards-Trinity (Plateau) region boundary
- Subcrop
 Perennial Stream Point

Figure 4.2.20 Estimated water-level elevation contours in feet above mean sea level in the Middle Trinity hydrostratigraphic unit in 2010.

Conceptual Model Report for the Hill Country Trinity Aquifer
Groundwater Availability Model

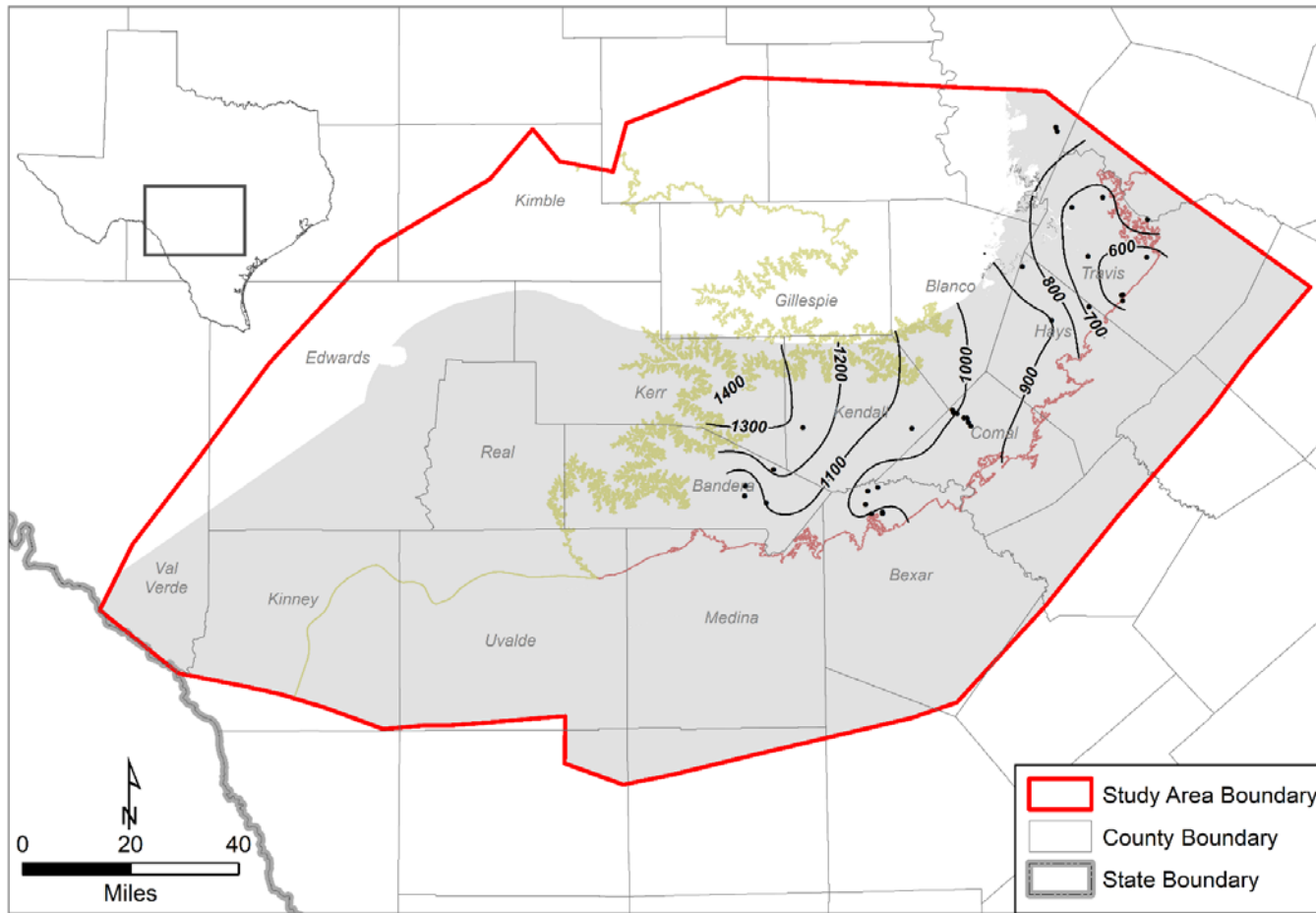

Water Level Elevation (feet) in the Lower Trinity Hydrostratigraphic Unit - 1990

- Water Level Contour
 Water Level Control Point
 Edwards (Balcones Fault Zone) region boundary
- Outcrop
 Spring
 Edwards-Trinity (Plateau) region boundary
- Subcrop
 Perennial Stream Point

Figure 4.2.21 Estimated water-level elevation contours in feet above mean sea level in the Lower Trinity hydrostratigraphic unit in 1990.

Conceptual Model Report for the Hill Country Trinity Aquifer
Groundwater Availability Model

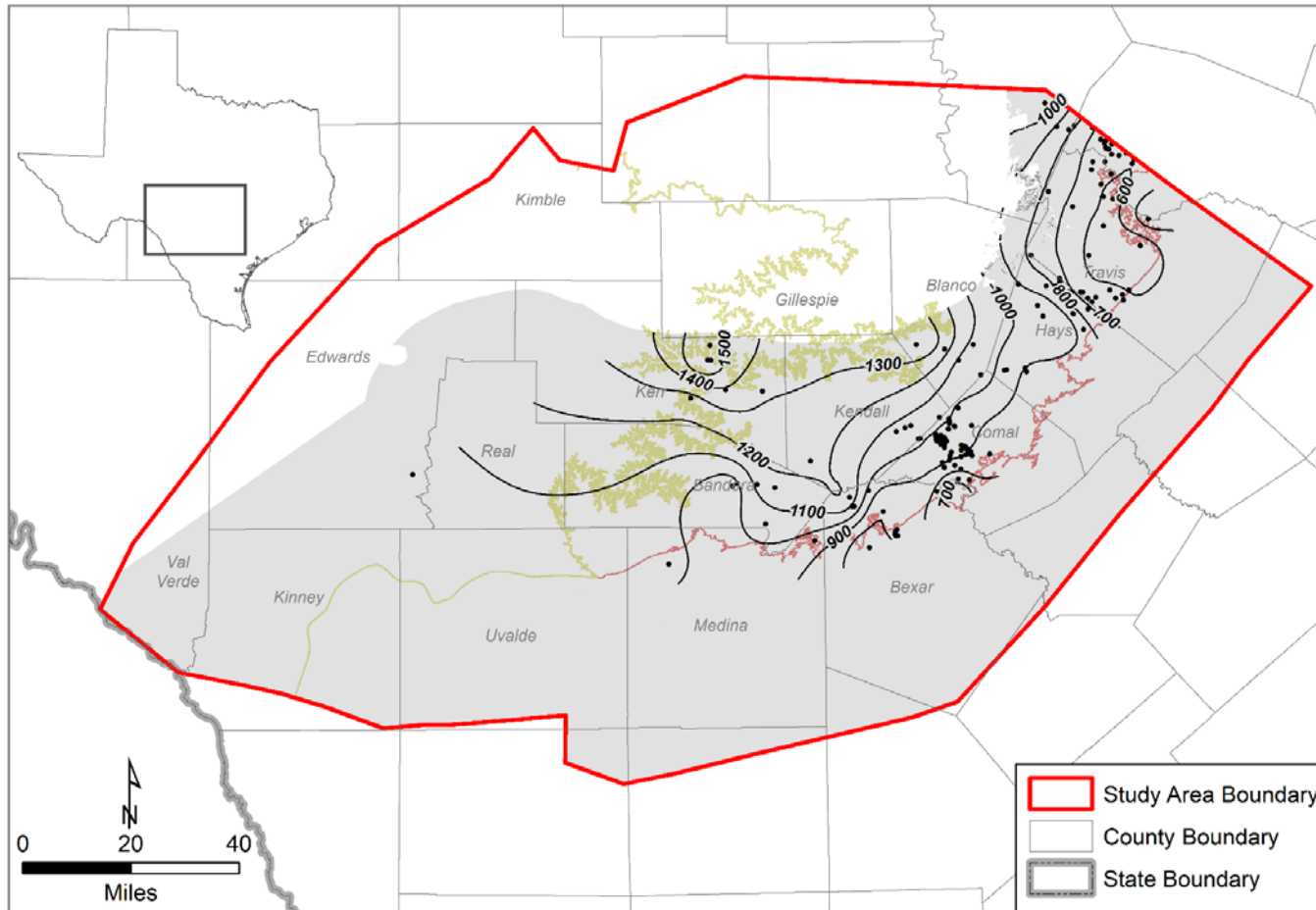

Water Level Elevation (feet) in the Lower Trinity Hydrostratigraphic Unit - 2000

- Water Level Contour
- Outcrop
- Subcrop
- Water Level Control Point
- Spring
- Perennial Stream Point
- Edwards (Balcones Fault Zone) region boundary
- Edwards-Trinity (Plateau) region boundary

Figure 4.2.22 Estimated water-level elevation contours in feet above mean sea level in the Lower Trinity hydrostratigraphic unit in 2000.

Conceptual Model Report for the Hill Country Trinity Aquifer
Groundwater Availability Model

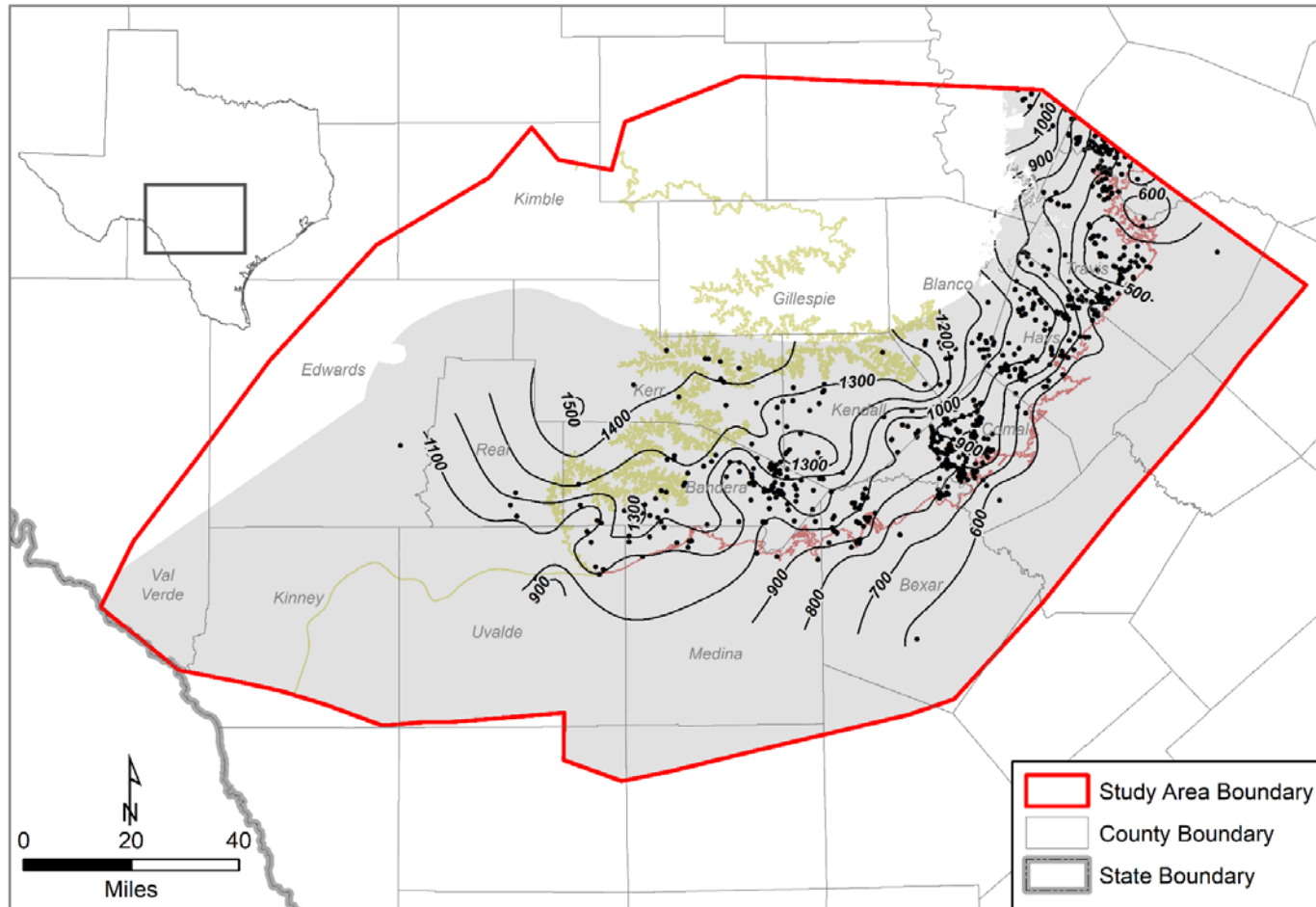

Water Level Elevation (feet) in the Lower Trinity Hydrostratigraphic Unit - 2010

- Water Level Contour
- Water Level Control Point
- Edwards (Balcones Fault Zone) region boundary
- Outcrop
- Spring
- Edwards-Trinity (Plateau) region boundary
- Subcrop
- Perennial Stream Point

Figure 4.2.23 Estimated water-level elevation contours in feet above mean sea level in the Lower Trinity hydrostratigraphic unit in 2010

Conceptual Model Report for the Hill Country Trinity Aquifer Groundwater Availability Model

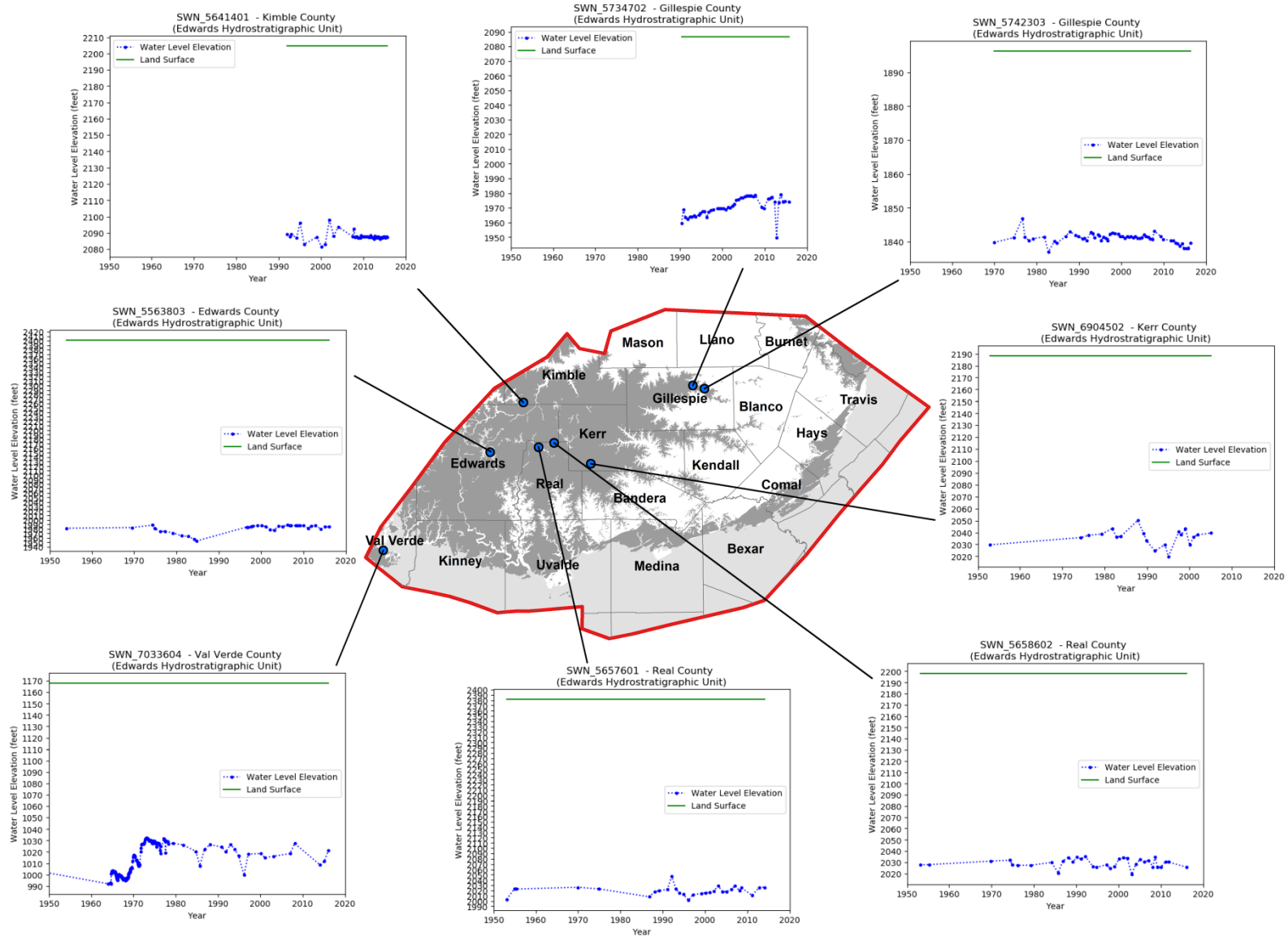

Figure 4.2.24 Select hydrographs for the Edwards hydrostratigraphic unit in the Edwards-Trinity (Plateau) region.

Conceptual Model Report for the Hill Country Trinity Aquifer Groundwater Availability Model

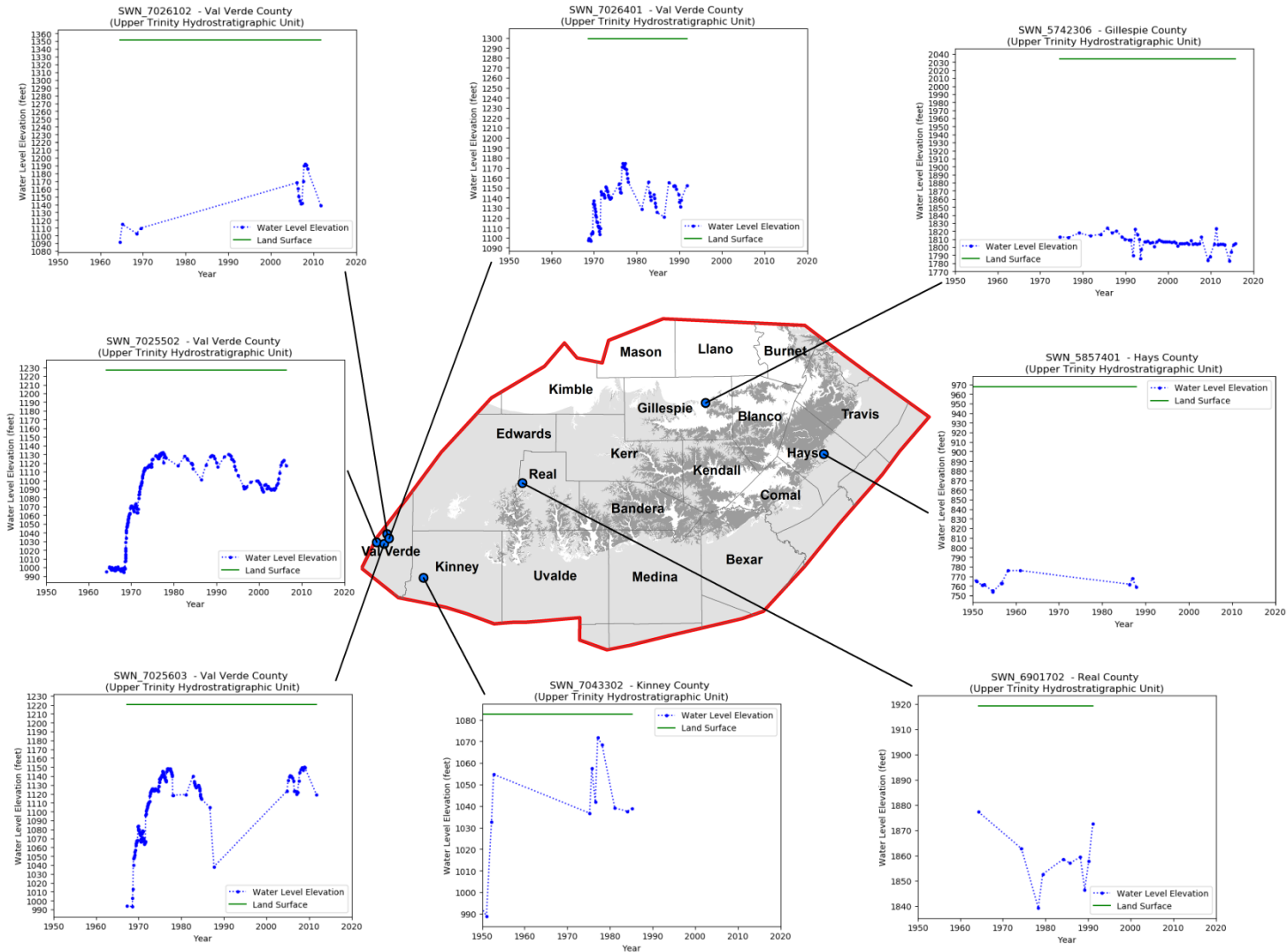

Figure 4.2.25 Select hydrographs for the Upper Trinity hydrostratigraphic unit.

Conceptual Model Report for the Hill Country Trinity Aquifer Groundwater Availability Model

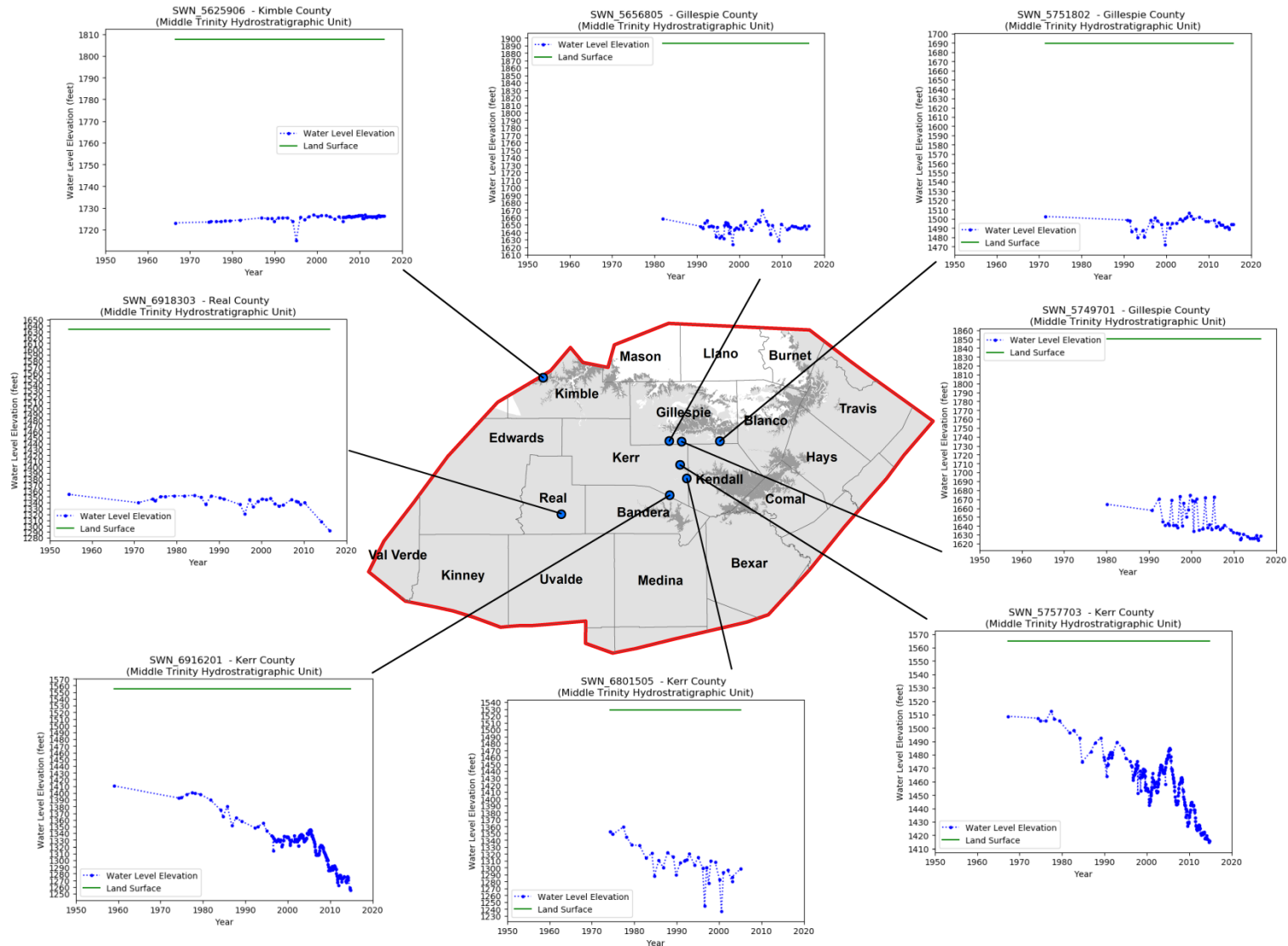

Figure 4.2.26 Select hydrographs for the Middle Trinity hydrostratigraphic unit in the west and west-central portions of the study area.

Conceptual Model Report for the Hill Country Trinity Aquifer Groundwater Availability Model

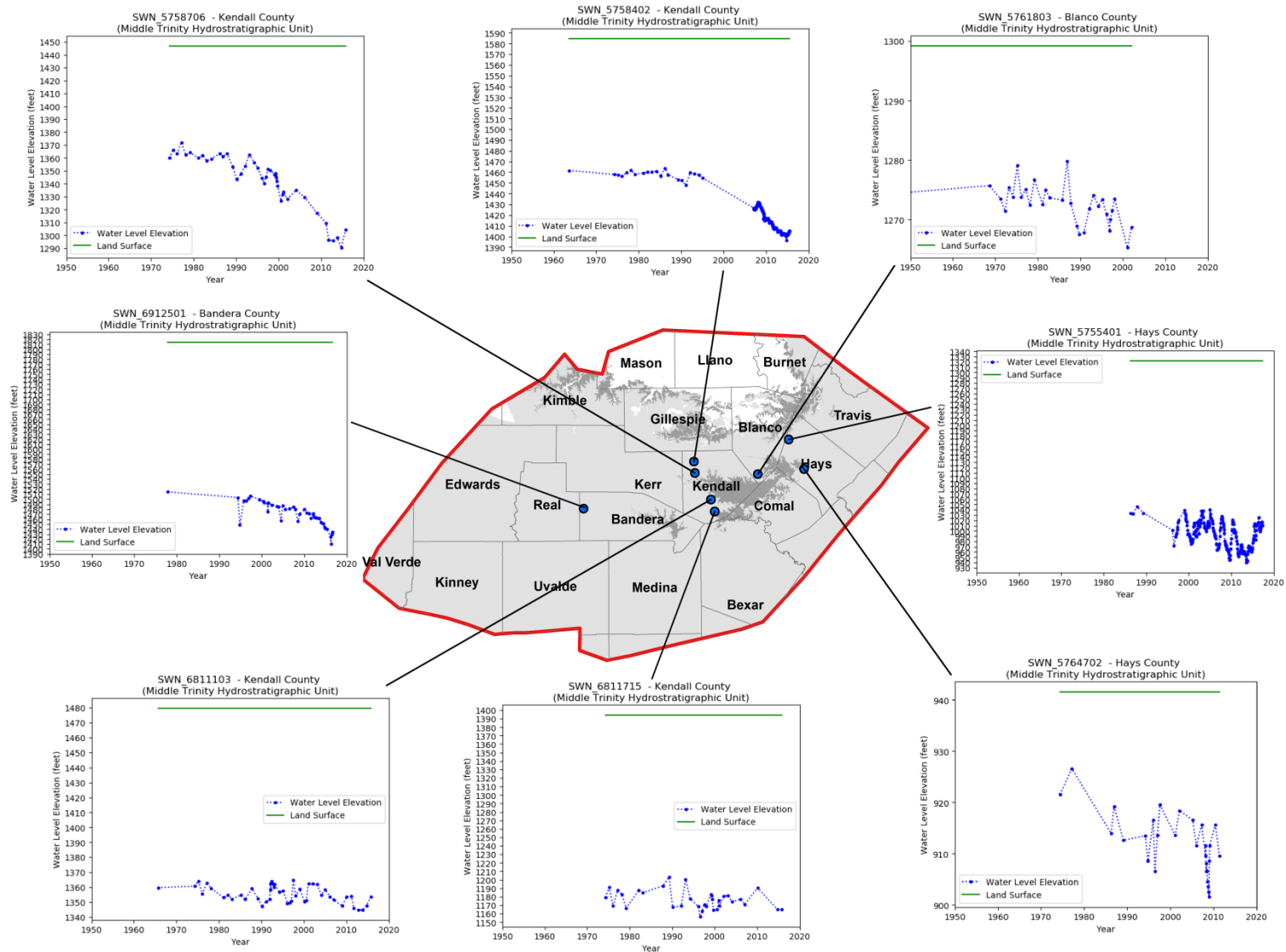

Figure 4.2.27 Select hydrographs for the Middle Trinity hydrostratigraphic unit in the east and east-central portions of the study area.

Conceptual Model Report for the Hill Country Trinity Aquifer Groundwater Availability Model

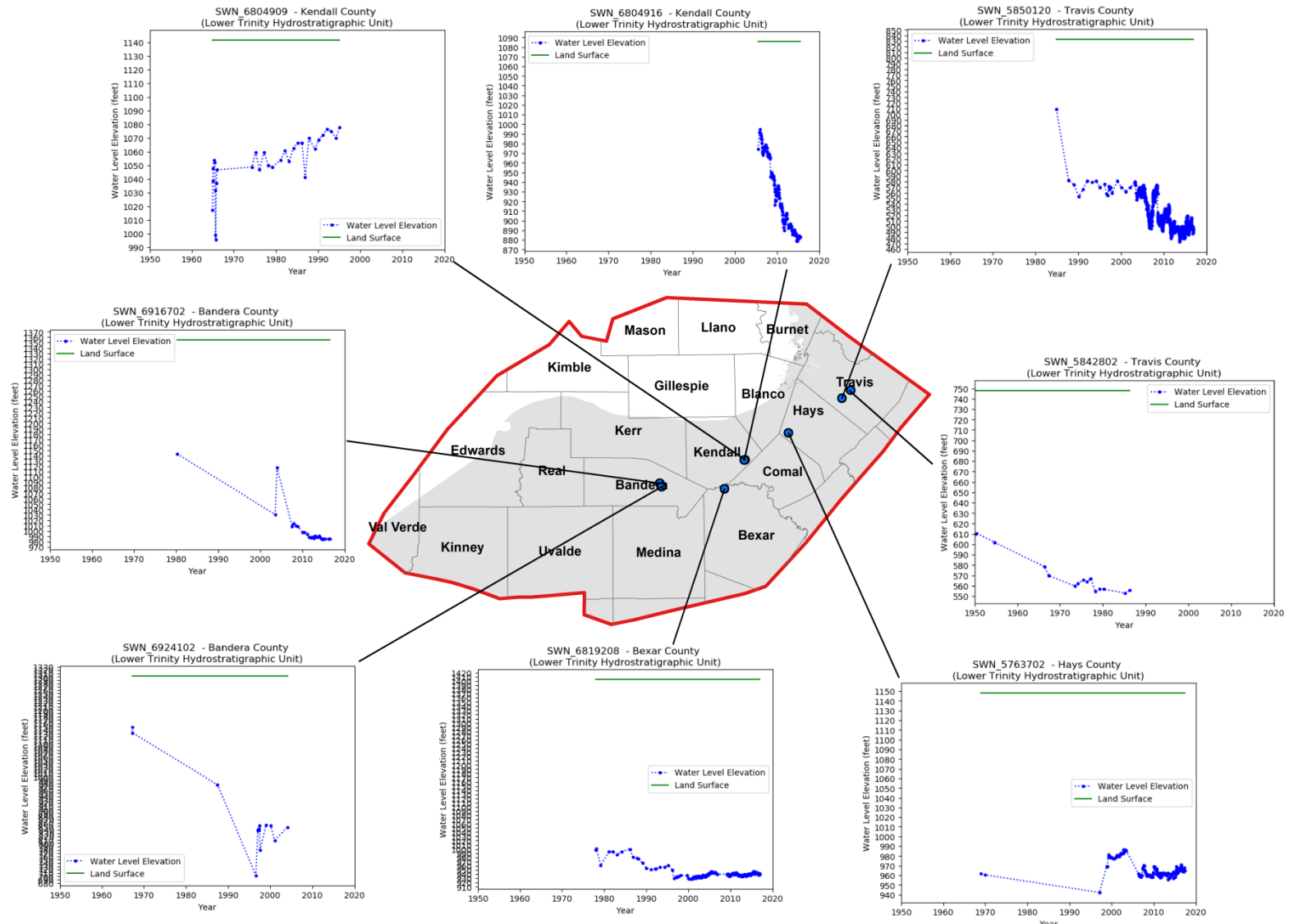

Figure 4.2.28 Select hydrographs for the Lower Trinity hydrostratigraphic unit in the study area.

Conceptual Model Report for the Hill Country Trinity Aquifer Groundwater Availability Model

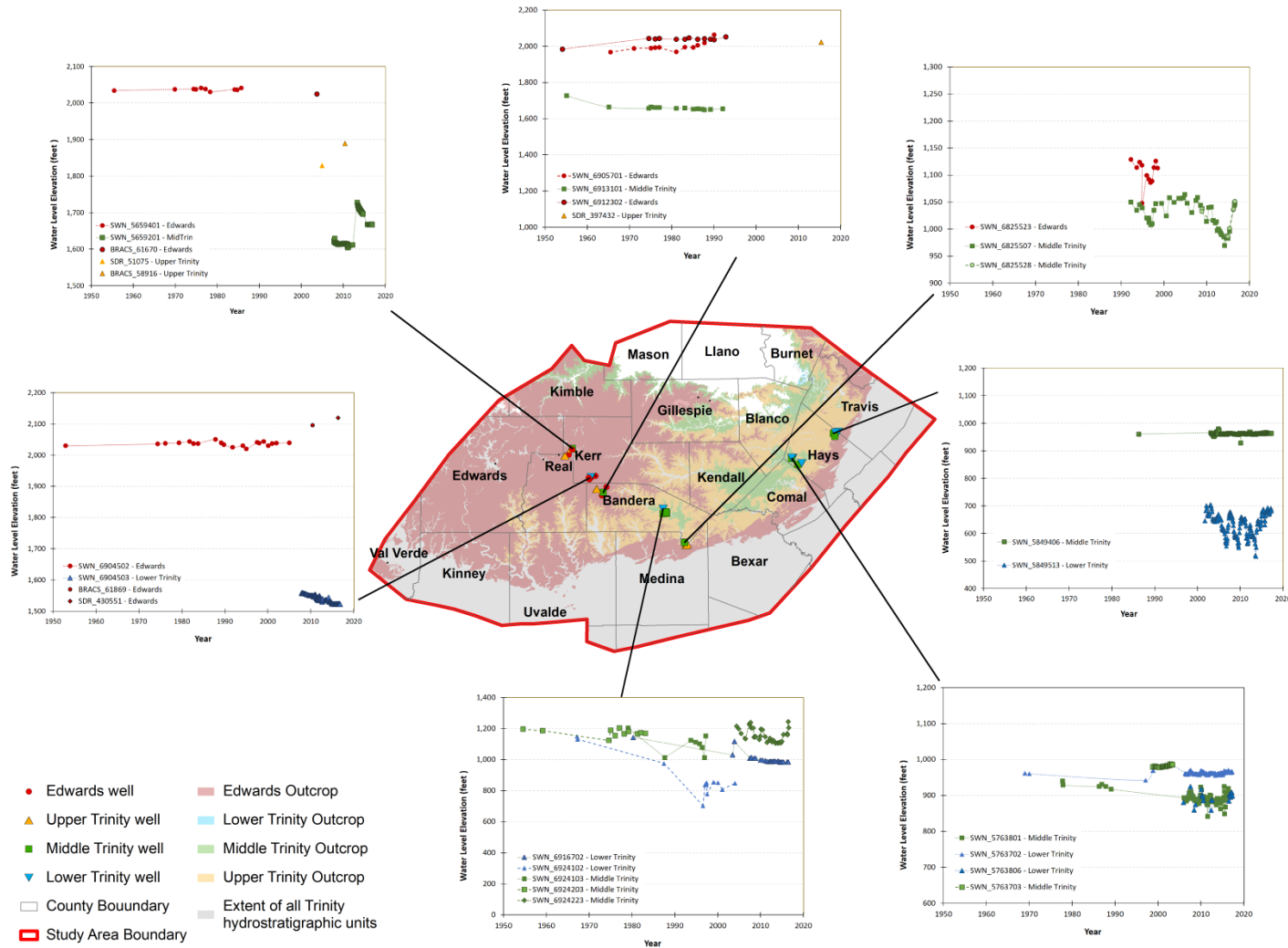

Figure 4.2.29 Comparison of water-level elevations between different hydrostratigraphic units.

4.3 Recharge

This section discusses the conceptual approach for estimating recharge in the HCT Aquifer conceptual model study area. Recharge to the Hill Country occurs as diffuse recharge in the upland areas and as focused recharge typically in river and stream channels (Banta and Slattery, 2011; Slattery and others, 2006; and Dugas and others, 1998). Although this is a fundamental question in the development of the conceptual model, there remains significant uncertainty as to the relative distribution of diffuse and focused recharge. Much of past investigation of recharge in the model domain targeted the Edwards (Balcones Fault Zone) Aquifer recharge zone; however, this body of work is relevant to recharge of the HCT Aquifer recharge zone because virtually all factors that influence recharge of the Edwards (Balcones Fault Zone) Aquifer are directly applicable to the HCT Aquifer. These include precipitation frequency and intensity, rock and soil type, vegetation, and climate. Seminal work by Puente (1978) has been relied on for the past four decades as the basis of the relative proportions of diffuse and focused recharge in the Edwards (Balcones Fault Zone) Aquifer recharge zone.

Investigation of recharge in the contributing zones of the Barton Springs (Hauwert, 2011) and the San Antonio (Fratesi and others, 2015) segments of the Edwards (Balcones Fault Zone) Aquifer explored the relative contributions of diffuse and focused recharge. A similar approach was used in the HCT Aquifer conceptual model to provide a tool to estimate the spatial and temporal distribution of recharge. There is particular relevance to the studies by Hauwert (2011), Fratesi and others (2015) in that the subject study areas are highly influenced by mechanisms associated with karstic terrains.

This discussion details the development of a simple Excel-spreadsheet-based tool that stores the relevant hydrologic parameters and performs calculations to spatially and temporally distributed recharge in the HCT Aquifer conceptual model study domain.

4.3.1 *Diffuse Recharge*

Diffuse recharge from precipitation was calculated by an analytical Excel-spreadsheet-based model. Once added to the future numerical model, diffuse recharge will flow through the subsurface in response to the hydraulic conductivity field and the hydraulic gradient. This approach makes it feasible to replicate the temporal lag between the time of precipitation and the time at which the recharge event was transmitted as a hydraulic impulse through the aquifer. The Excel-workbook contains the monthly precipitation values for every 4-km by 4-km cell in the HCT study area. The Excel-spreadsheet is saved in the GAM data directory under \Recharge Model\ Recharge_v1_5-7-18.xlsx.

Recharge is calculated directly from precipitation data representative for the outcrop area of the HCT Aquifer. Parameter-elevation Relationships on Independent Slopes Model (PRISM) precipitation data acquired from the PRISM website (<http://prism.oregonstate.edu/>) are available for the study area ranging from 1980-2015. PRISM datasets utilized for this study include precipitation as well as maximum and minimum temperature. PRISM datasets are useful for determining the average precipitation over a 30-year period, considered to be the standard averaging period in order to describe the long-term climate of a given region. PRISM datasets

Conceptual Model Report for the Hill Country Trinity Aquifer
Groundwater Availability Model

are calculated using a climate–elevation regression for every digital elevation model (DEM) grid cell. For this regression, monitoring stations are assigned weights based primarily on the physiographic similarity of the station to the 4-km by 4-km grid cell. The factors considered in the regression are elevation, location, topographic facet orientation, topographic position, coastal proximity, vertical atmospheric layer, and orographic effectiveness of the terrain (PRISM Climate Group, 2014).

Monthly precipitation data from the Oregon State Prism Climate Group were downloaded for the period of January 1980 to March 2015. The monthly precipitation raster data sets were clipped for the project area. A polygon grid that corresponds to the prism raster cells for the study area was created (Figure 4.3.1). Each grid cell was assigned a pixel ID and a center-point shapefile was created for each pixel cell. Each cell was then assigned evaporation quadrant IDs and River/Stream basin IDs. The PRISM raster grid cells and the evaporation quadrangles are shown on Figure 4.3.1. The PRISM raster grid cells and the HUC-6 river basins are shown on Figure 4.3.2.

Precipitation for each precipitation pixel in the study area was converted to recharge using an algorithm implemented in Excel, accounting for antecedent moisture and seasonal variability. Recharge was calculated by multiplying moisture by the amount of precipitation less the amount of pan evaporation according to the following equation (Fratesi and others, 2014):

$$R_i = \sum_i^{i-5} \Phi_i (\text{Min}(P_i, \text{Max}P) - aE_i) \quad \text{Eq 4.3.1-1}$$

where:

R_i = recharge during month i for pixel

P_i = precipitation during month i

E_i = average pan evaporation for month i

Φ_i = weighting factor for antecedent moisture for month i

a = Evapotranspiration scaling factor

i = month indicator

$\text{Max}P$ = Maximum monthly precipitation allowed to recharge the aquifer

This algorithm accounts for the fact that recharge is greater in the winter than in the summer due to decreased evapotranspiration during the winter. Losses due to evapotranspiration are calculated from time series data of monthly gross-lake evaporation rates obtained using TWDB data for the period 1980-2015. Data were downloaded for the study area in quadrangles 708, 709, 710, 807, 808, 809, and 810. Average lake evaporation by month varies from a high of 9 inches in July to a low of 2 inches in December and January. The average evaporation rate for each evaporation quadrangle is summarized in Figure 4.3.3. TWDB lake evaporation datasets were utilized to create a table of pan evaporation rates for every month and every quadrant for the period of January 1980 to March 2015 in every evaporation quadrant as delineated by the TWDB. Pan evaporation for each quadrant was calculated using this TWDB lake evaporation-rate, time-series data and dividing the value for each evaporation quadrant on a given month by the pan to lake evaporation coefficient. Pan evaporation is determined in the Excel spreadsheet for every cell and every month by a lookup table utilizing the evaporation quadrant ID assigned to every cell.

Conceptual Model Report for the Hill Country Trinity Aquifer Groundwater Availability Model

The antecedent moisture weighting factors are calibration parameters and should be adjusted during numerical model calibration. The initial antecedent weighting factors Excel-spreadsheet model has been populated with values extrapolated from the Edwards Aquifer Authority finite-element model (Table 4.3.1) (Fratesi and others, 2014). The initial antecedent weighting factors used in the Excel-spreadsheet model are provided in Table 4.3.1. The antecedent weighting factors are independently set for each river/stream basin. The Excel spreadsheet allows a lookup to identify the factors to use in the calculation for each pixel. The amplitudes of these weighting factors are adjusted during calibration of the numerical model. The calibrated volume of recharge is a reflection of correct natural and anthropogenic discharge quantities.

Lastly, the temporal duration represented by the algorithm is adjusted so that the duration of recharge is commiserate with the duration of a precipitation event such that recharge is consistent with the “hydraulic memory” of the aquifer system in the contributing and recharge zones of the HCT Aquifer. Again, the temporal duration is independently set for each river/stream watershed basin. The Excel spreadsheet allows a lookup to identify the temporal duration factors to use in the calculation for each pixel. The default temporal duration factors used in the Excel-spreadsheet model are provided in Table 4.3.1.

Increased precipitation losses to surface runoff during large storms or periods of intense rainfall are accounted for by capping the amount of precipitation allowed to be applied as recharge during any single month. To accomplish this, a maximum threshold for monthly precipitation is applied. The default maximum threshold is 8.0 inches for all watersheds. Using the PRISM precipitation data with the assigned seasonal and antecedent weighting factors, recharge for each month is calculated by the excel spreadsheet for each 4-km by 4-km pixel in the study area as an example. The distribution of recharge in the study area for two selected months, representing the lowest recharge and the highest recharge, calculated by the analytical model are shown in Figure 4.3.4 and Figure 4.3.5.

4.3.2 Focused Recharge

Focused recharge from precipitation was calculated by a separate analytical Excel-spreadsheet-based model. The focused recharge Excel-workbook contains the monthly precipitation values for every 4-km by 4-km prism cell in the HCT study area that is within catchments that recharge the Trinity aquifer formations. The Excel-spreadsheet is saved in the GAM data directory under \Recharge Model\FocusedRecharge_v1.xlsx.

The PRISM polygon grid described in Section 4.3.1 was clipped to the extent of the HCT Aquifer study area that is within catchments that recharge the Trinity Aquifer formations (Figure 4.3.6). A derivative polygon feature class was created where major streams and rivers in the study area intersect PRISM cells. Cell centers for each grid feature were converted to points. Using the *NEAR* geoprocessing tool in ArcGIS a matrix of distances from PRISM cells to nearest streamnode was created.

Precipitation for each precipitation pixel in the study area was converted to focused recharge using an algorithm implemented in Excel, accounting for antecedent moisture and seasonal

Conceptual Model Report for the Hill Country Trinity Aquifer
Groundwater Availability Model

variability. Recharge was calculated by multiplying moisture by the amount of precipitation less the amount of pan evaporation according to the following equation:

$$R_i = \sum_1^n (Min(P_n, MaxP) * (\%focused\ at\ Cell_n * IDW)) \quad \text{Eq 4.3.1-2}$$

where:

- R_i = focused recharge during month i for stream pixel
- P_n = precipitation during month i for each PRISM pixel associated with stream node
- % focused = % of P_n destined for focused recharge set for each basin or each cell
- IDW = Distance Weighting = $1 - (\text{Distance Cell}_n / \text{Max Basin Distance})$
- i = month indicator
- $MaxP$ = Maximum monthly precipitation allowed to recharge the aquifer

This algorithm accounts for the fact that a fraction of precipitation runoff will report to streams and rivers where it may enter the groundwater system as focused recharge. The percentage of precipitation reporting to the stream cell from any given PRISM cell is determined by the percentage of focused precipitation factor and the distance between the PRISM cell and the stream cell. The percentage of focused precipitation is set on a basin by basin basis and should be adjusted during calibration. The distribution of focused recharge in the study area for two selected months, representing the lowest recharge and the highest recharge, calculated by the analytical model are shown in Figure 4.3.7 and Figure 4.3.8. The combined focused and diffuse recharge for both months is illustrated in Figures 4.3.9 and 4.3.10.

Table 4.3.1 **Default Weighting factors, Φ_i , Max P, and a to account for antecedent moisture and evaporation**

Basin	Φ_i	Max P (inches)	a
Middle Colorado-Concho	0.2	8	0.4
Middle Colorado-Llano	0.33	8	0.4
Little	0.2	8	0.6
Lower Colorado	0.2	8	0.6
Lower Brazos	0.2	8	0.6
Devils	0.2	8	0.4
Guadalupe	0.363	8	0.4
Nueces	0.2	8	0.4
San Antonio	0.11	8	0.4
Rio Grande-Falcon	0.2	8	0.4
Rio Grande-Amistad	0.2	8	0.4

Conceptual Model Report for the Hill Country Trinity Aquifer
Groundwater Availability Model

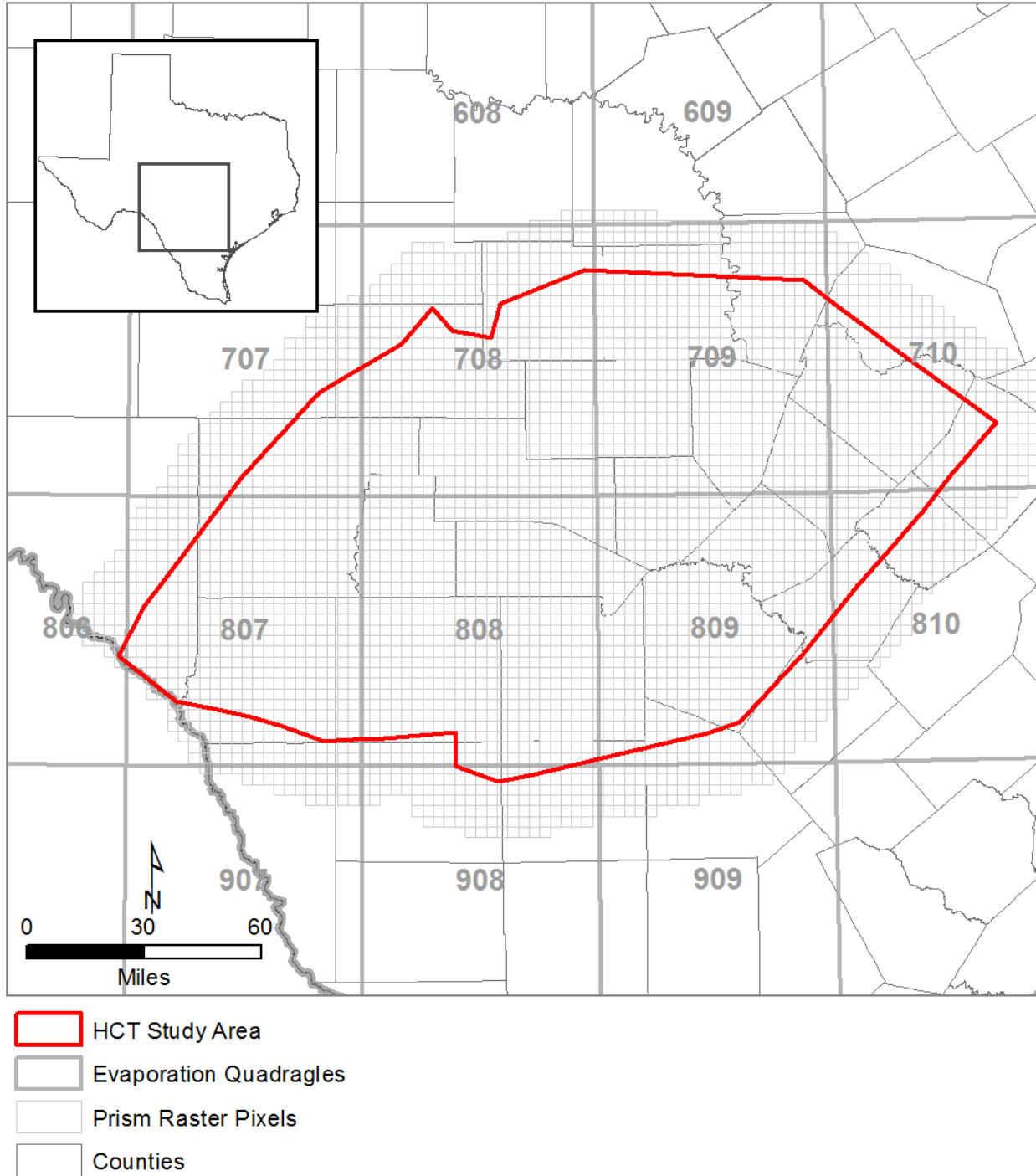

Figure 4.3.1 Map showing the location of the evaporation quadrangles and PRISM precipitation raster pixels used to calculate diffuse recharge within the conceptual model study area.

Conceptual Model Report for the Hill Country Trinity Aquifer
Groundwater Availability Model

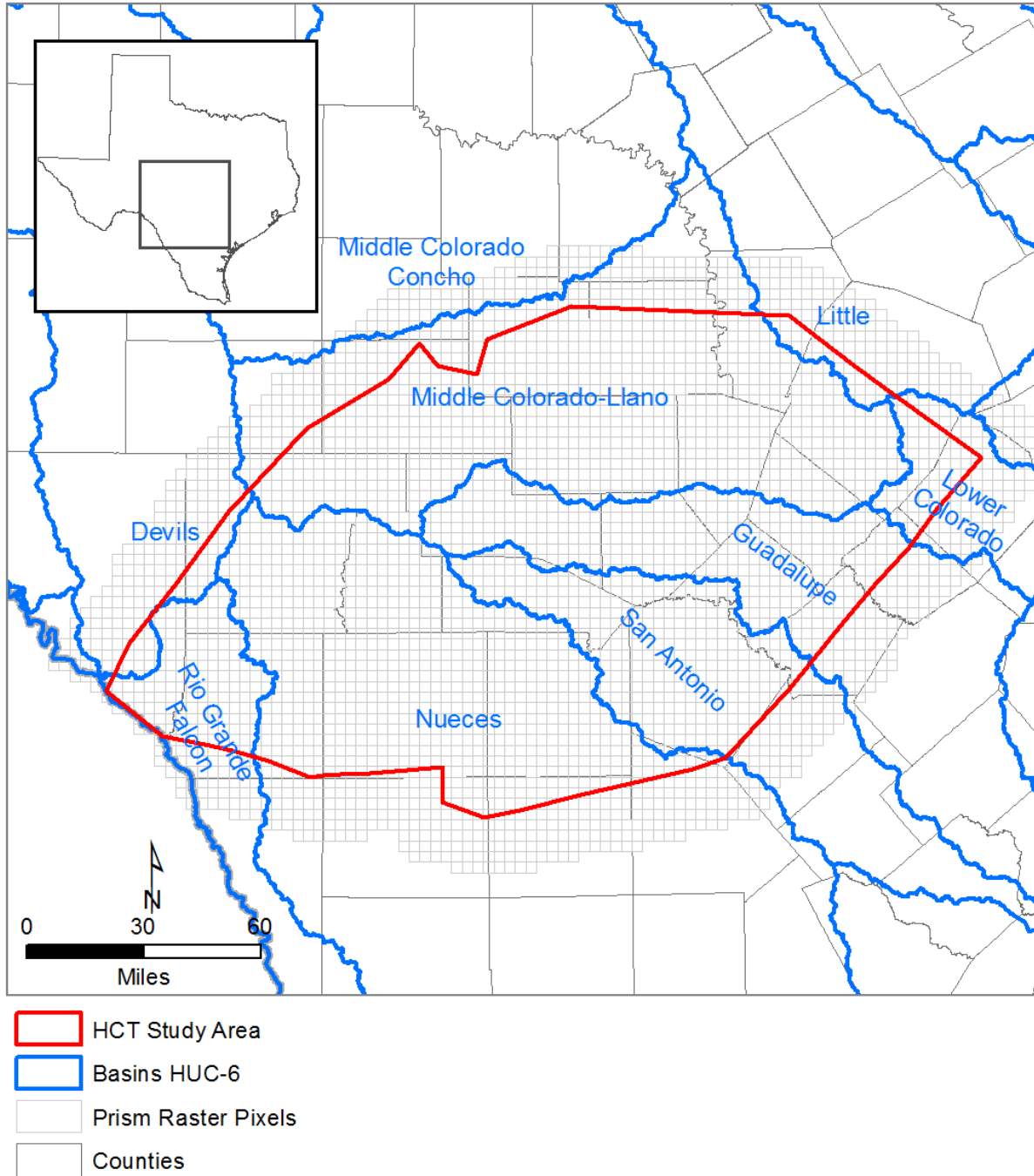

Figure 4.3.2 Map showing the locations of PRISM raster pixels and the HUC-6 basins they fall within.

Conceptual Model Report for the Hill Country Trinity Aquifer Groundwater Availability Model

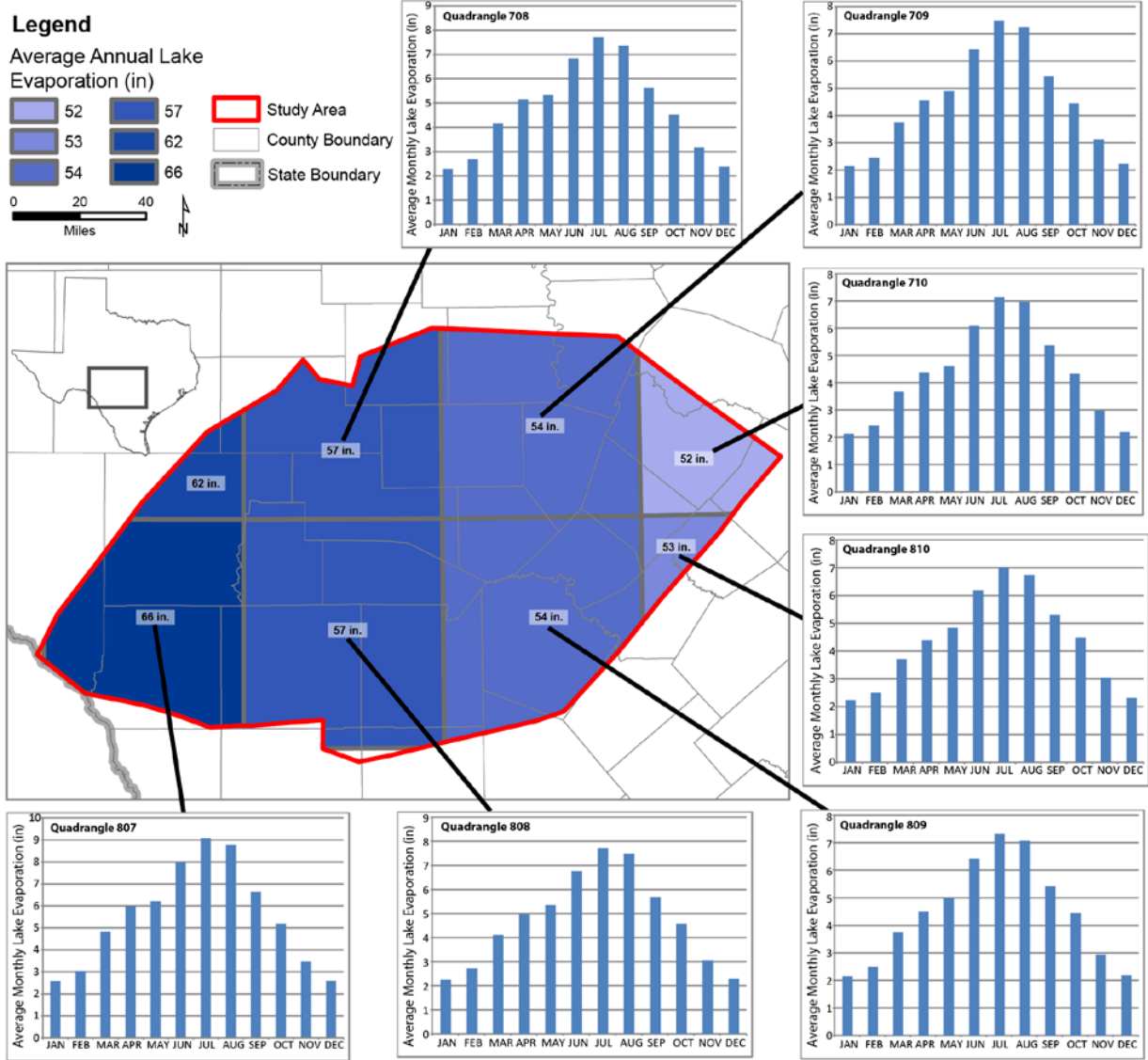

Figure 4.3.3 Average annual lake evaporation for each quadrangle in the study area. Average annual lake evaporation for each month in each quadrangle is shown in the respective graph.

Conceptual Model Report for the Hill Country Trinity Aquifer
Groundwater Availability Model

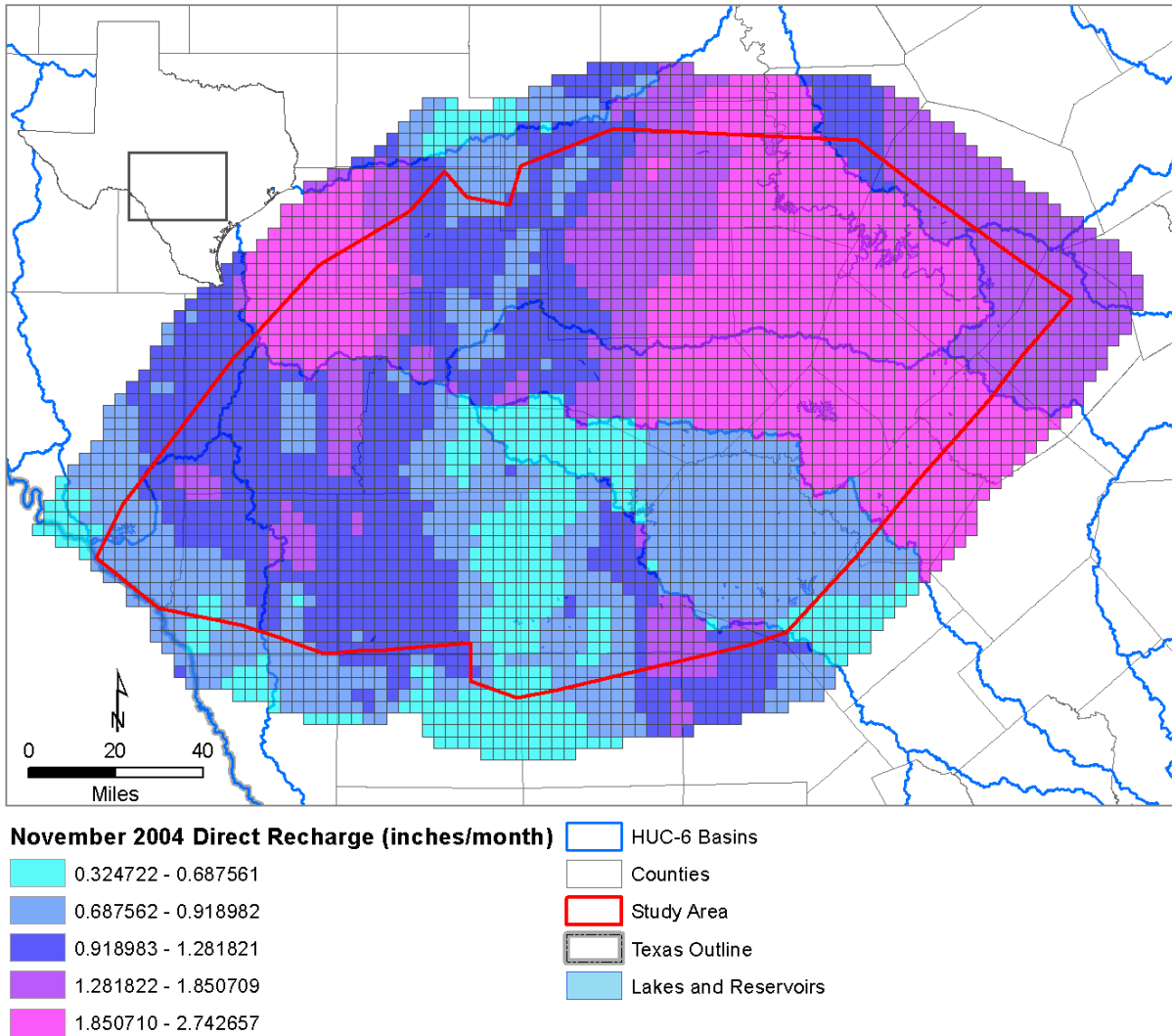

Figure 4.3.4 Distribution of diffuse recharge in November 2004 calculated using the Excel Analytical Model populated with default values.

Conceptual Model Report for the Hill Country Trinity Aquifer
Groundwater Availability Model

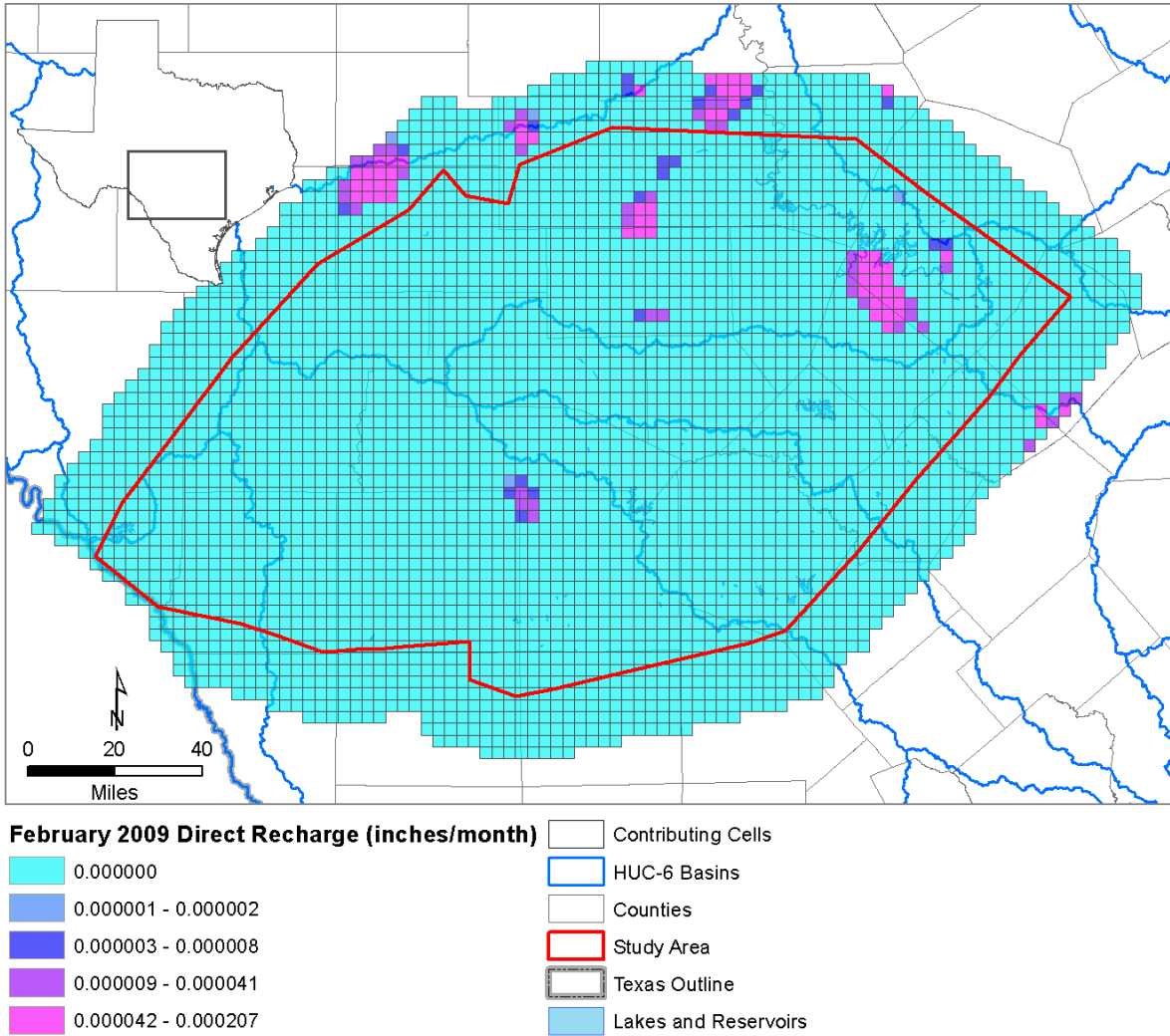

Figure 4.3.5 Distribution of diffuse recharge in February 2009 calculated using the Excel Analytical Model populated with default values.

Conceptual Model Report for the Hill Country Trinity Aquifer
Groundwater Availability Model

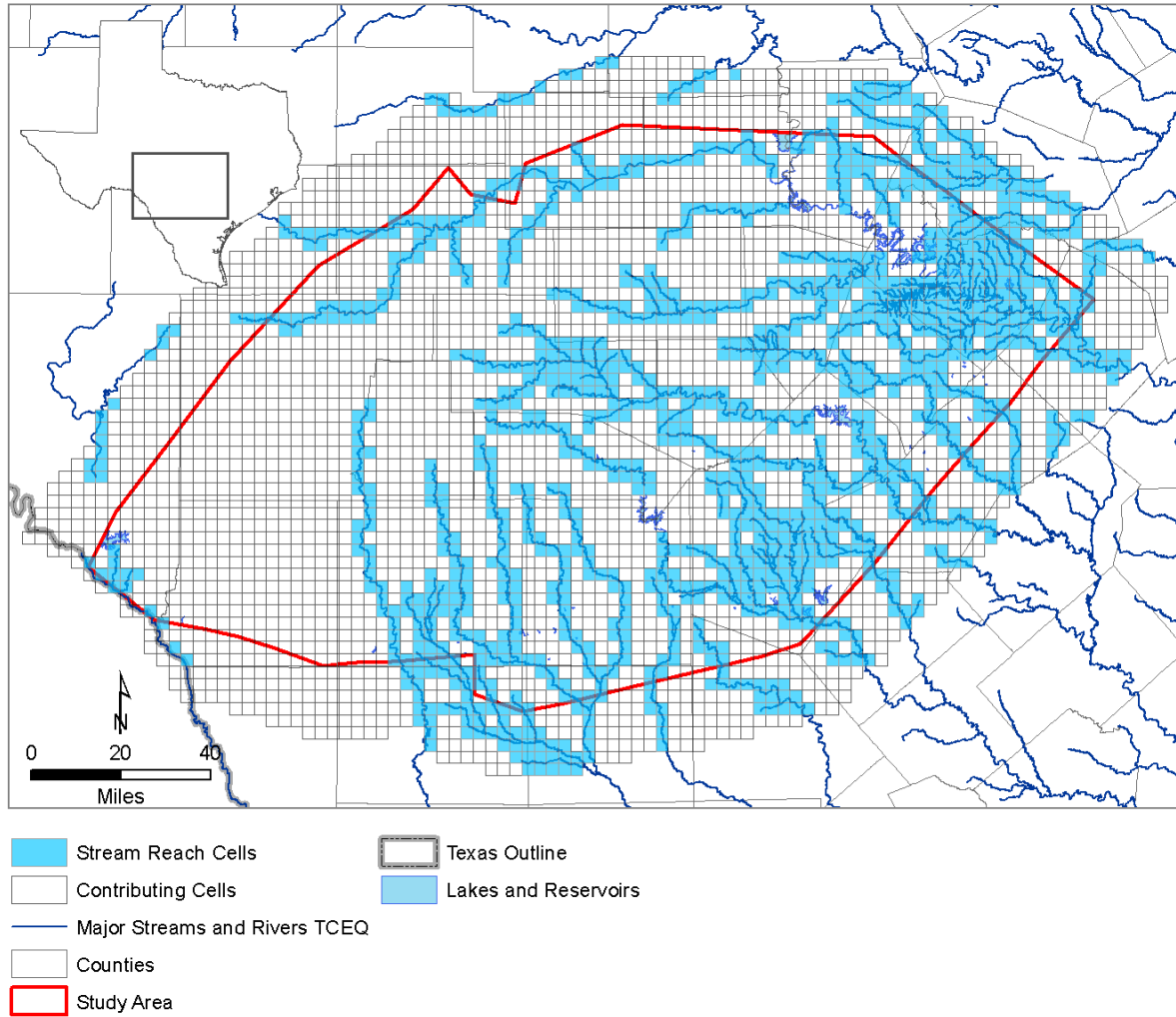

Figure 4.3.6 PRISM pixel cells used to calculate focused recharge in outcrop area of HCT study area. The unshaded cells are cells where precipitation is scaled and assigned to stream cells shaded in blue.

Conceptual Model Report for the Hill Country Trinity Aquifer
Groundwater Availability Model

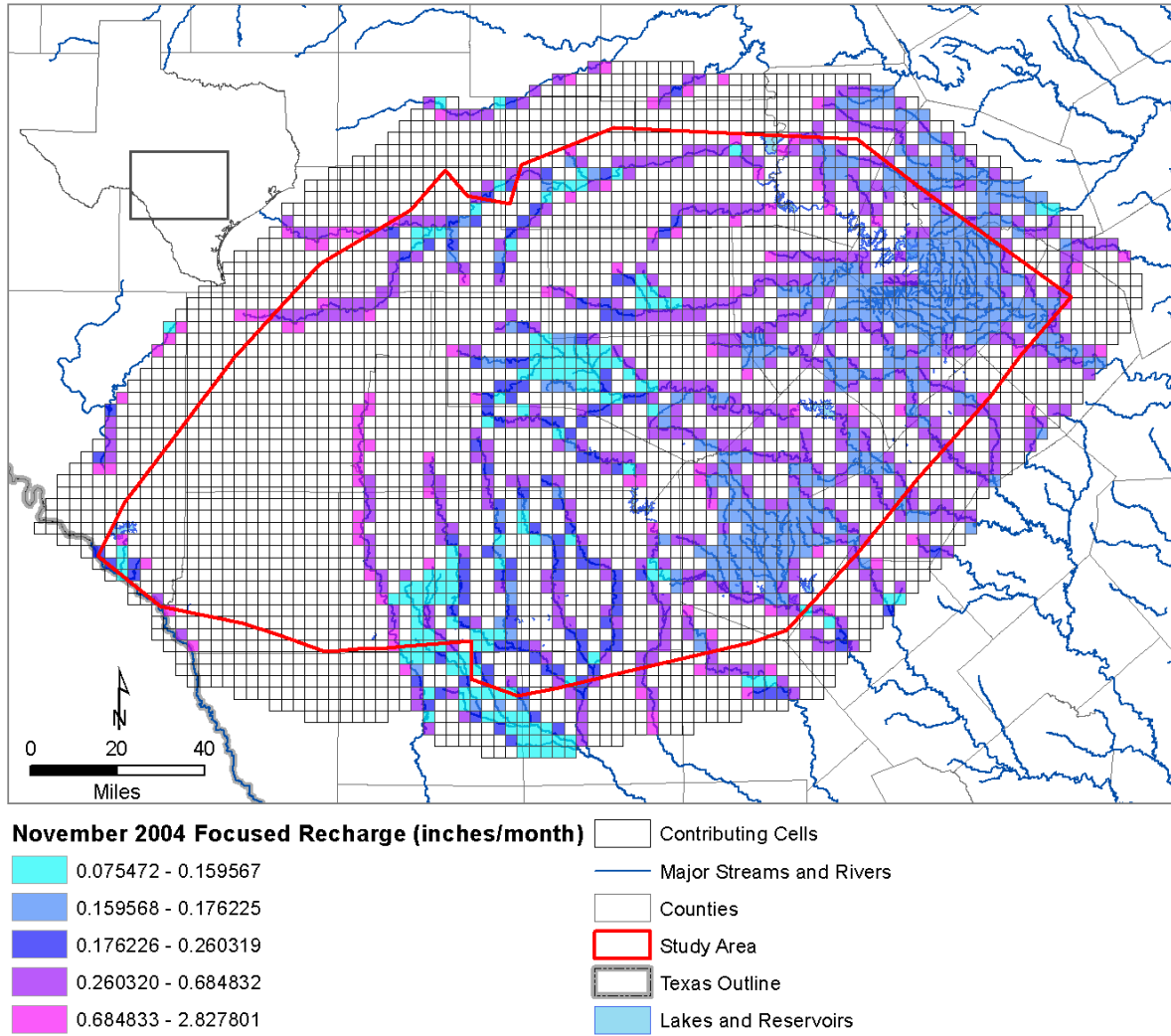

Figure 4.3.7 Calculated Focused recharge using 2% of precipitation at every PRISM cell directed to the nearest major stream or river and scaled according to its distance from the stream. November 2004 selected since it is the wettest month in the period 1980 to 2015.

Conceptual Model Report for the Hill Country Trinity Aquifer
Groundwater Availability Model

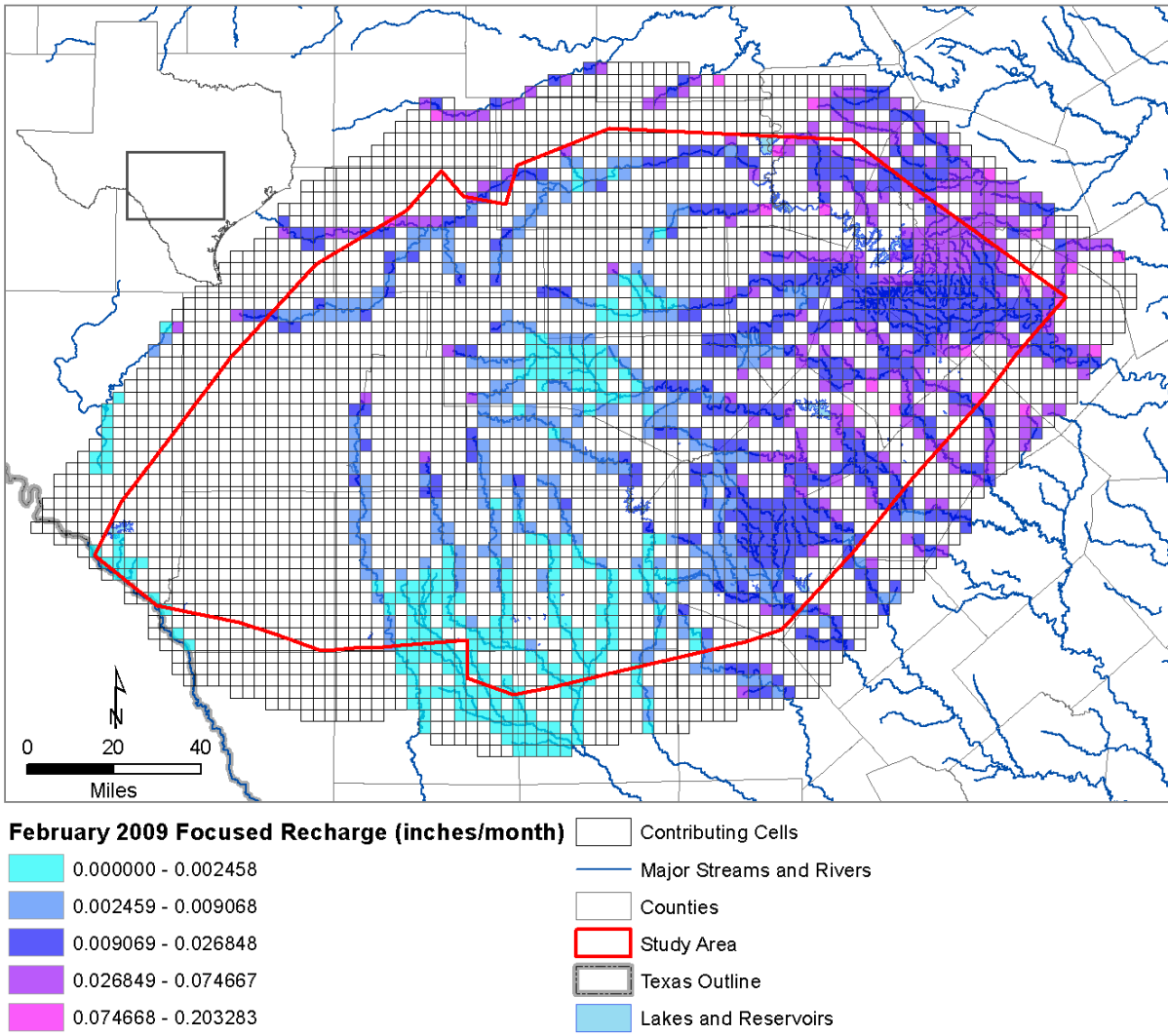

Figure 4.3.8 Calculated Focused recharge using 2% of precipitation at every PRISM cell directed to the nearest major stream or river and scaled according to its distance from the stream. February 2009 selected since it is the driest month in the period 1980 to 2015.

Conceptual Model Report for the Hill Country Trinity Aquifer
Groundwater Availability Model

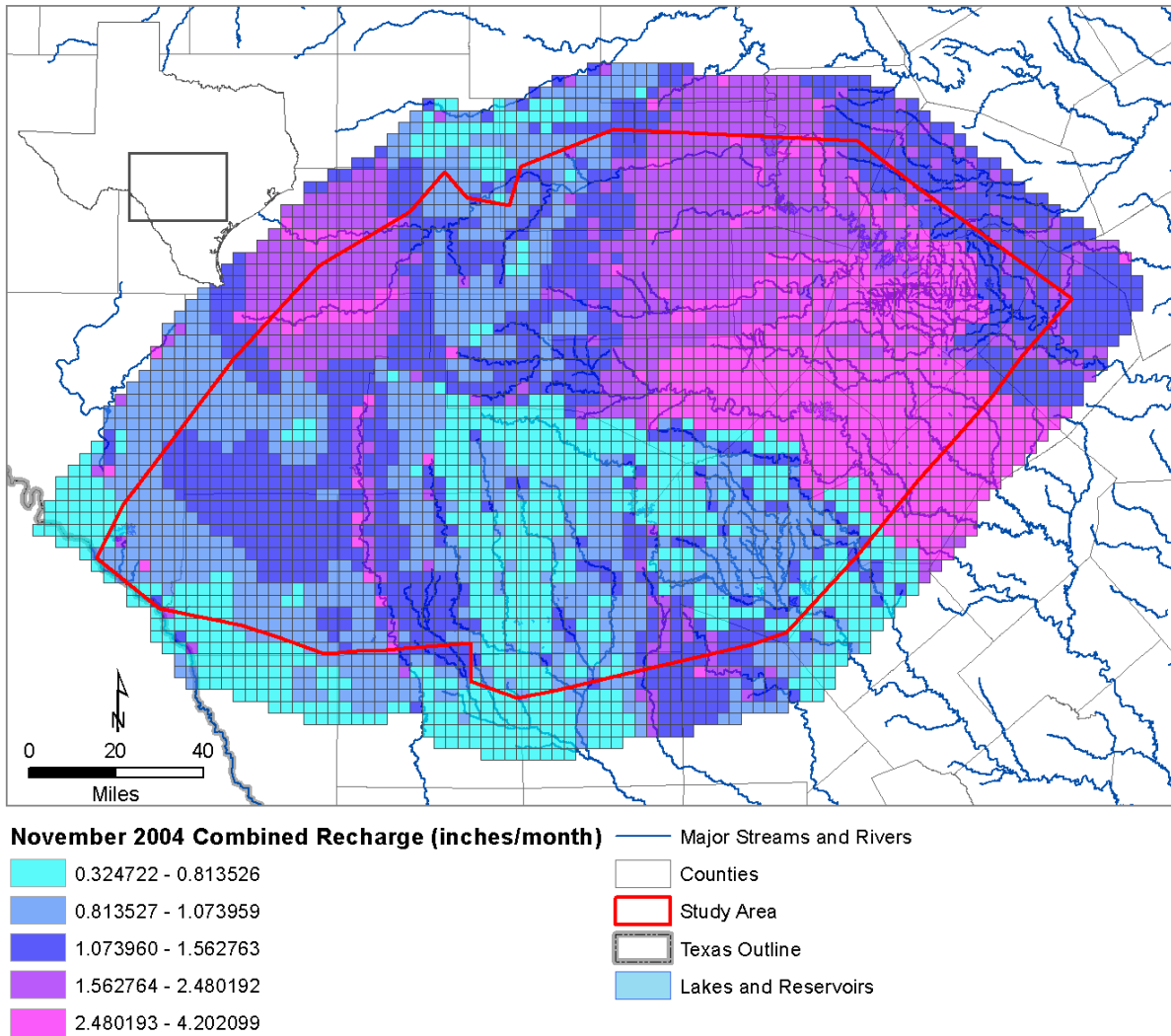

Figure 4.3.9 Combined focused and diffuse recharge for November 2004 (inches/month)

Conceptual Model Report for the Hill Country Trinity Aquifer
Groundwater Availability Model

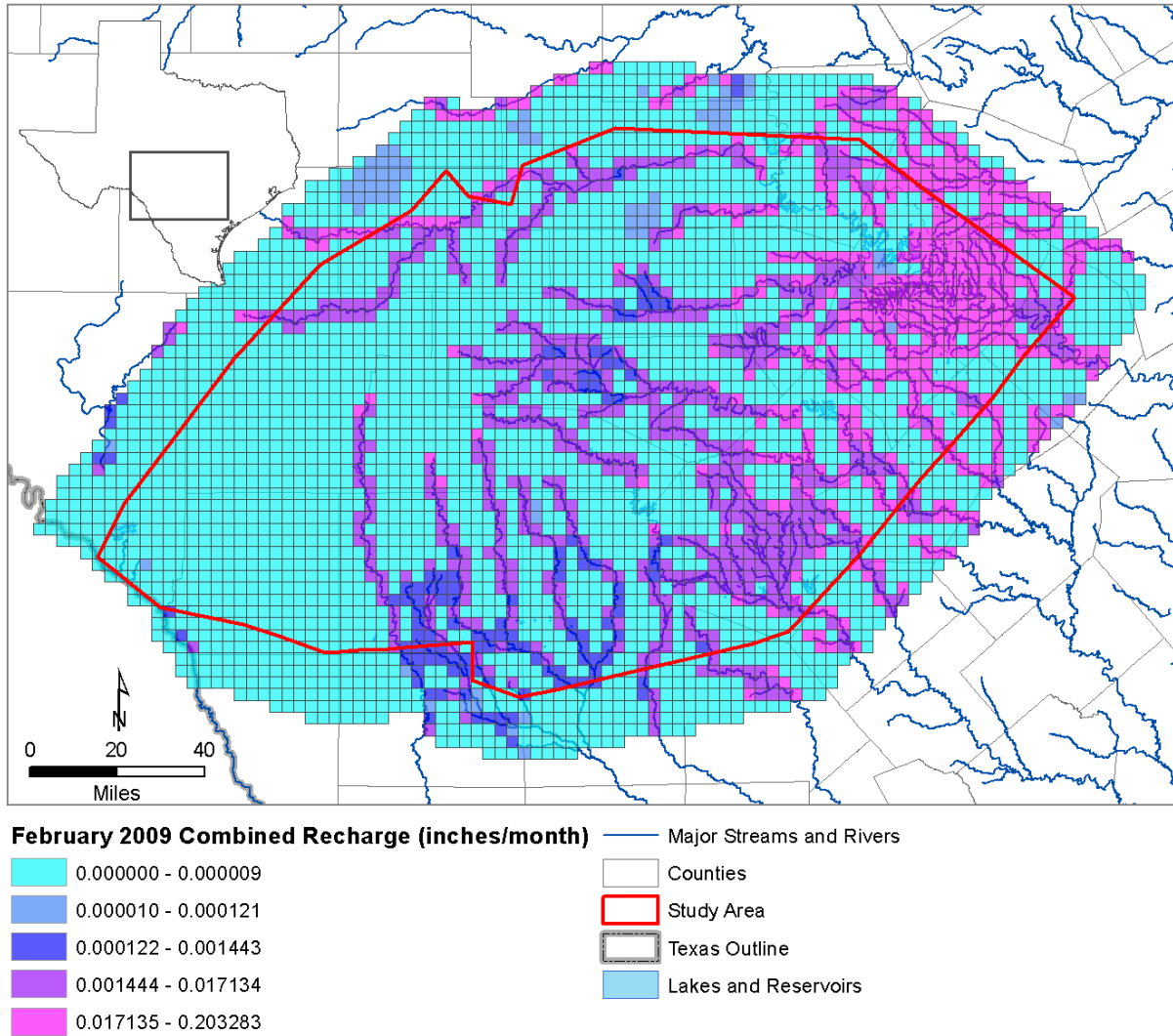

Figure 4.3.10 Combined focused and diffuse recharge for February 2009 (inches/month)

4.4 Rivers, Streams, and Lakes

Surface-water/groundwater interaction occurs primarily where surface water intersects aquifer outcrops. At these intersections, flow is between rivers and streams, springs, and lakes, and the aquifer. Direction of flow (i.e. flow from the surface-water system into the aquifer or vice versa) depends on the relative hydraulic head of groundwater and surface water, with water flowing from relatively high to relatively low hydraulic head.

4.4.1 Rivers and Streams

Interactions between rivers and streams and groundwater depend on the relative elevation of the stream stage of the river or stream and the elevation of the water table in the aquifer. For gaining streams, the elevation of the water table in the aquifer is higher than the stream-stage elevation and therefore water flows from the aquifer to the stream. For losing streams, the stream-stage elevation is higher than the elevation of the water table in the aquifer and therefore water flows from the stream into the aquifer.

The major rivers and streams in the HCT Aquifer study area and the locations of USGS gauges on the rivers are shown in Figure 4.4.1. Hydrographs of key gauging stations are presented in Figure 4.4.2. Daily-stream flow data have been extracted from the USGS National Water Information System (NWIS) website (USGS, 2018). Streamflow contains stormflow from overland flow and groundwater contributions. The groundwater contribution is reported as the baseflow to the stream. An automated empirical method for estimating the baseflow fraction of the total streamflow was applied to each gauging station dataset. The automated method, called Baseflow, was developed by Arnold and others (1995) and Arnold and Allen (1999) and relies on a recursive digital filter to separate baseflow from streamflow-recession slopes after storm events. The software code Baseflow was acquired from the Texas A&M University soil and water-assessment tool website (TAMU, 2018). Hydrographs presented in Figure 4.4.2 have both total daily streamflow and second-pass baseflow fractions calculated using the baseflow filter software reported. Parameters for each gauging location calculated with the automated baseflow-separation method are summarized in Table 4.4.1. Baseflow fractions reported are useful to constrain the amount of aquifer recharge in each stream's contributing watershed. The baseflow timeseries data are useful as model calibration targets given that the majority of discharge in the HCT Aquifer study area occurs as springflow to streams and rivers.

The headwaters of the major rivers in the HCT Aquifer study area arise along the eastern margin of the Edwards (Plateau) and descend with a steep gradient into the Hill Country (Figure 4.4.1). Many of these streams have upper reaches contained within narrow canyons and broaden into flat-bottomed valleys farther downstream (Barker and Ardis, 1996). Four major drainage basins—the Nueces, San Antonio, Guadalupe, and Middle Colorado-Llano rivers—traverse the study area and funnel flow toward the southeast. These rivers are interpreted to be hydraulically connected to the regional-flow system (Kuniansky, 1990).

Historically, the major rivers in the Hill Country have been classified as gaining in the upland area and losing in the recharge zone. The upland areas have been shown to be more complex than this observation, although, there may be a general tendency for spring discharge to cause rivers to gain in upland areas (Hauwert, 2009, 2011). Gain/loss measurements for the HCT Aquifer study area provide insight into this classification. Data from multiple gain/loss studies

that were summarized by Slade and others (2002) were collected at different times and do not represent synoptic studies (Figure 4.4.3). This factor obfuscates the database because of the variable nature of stream flow in the Hill Country. Repeat streamflow measurements in the Hill Country illustrate that stream and river changes can change between gaining and losing when observed during different hydrologic conditions.

The major rivers in the study area are typically perennial, although certain reaches may lose surface flow particularly when flowing across areas with significant recharge. Lower reaches of most of the streams lose significant quantities of flow where they cross the recharge zone of the Edwards (Balcones Fault Zone) Aquifer (Barker and others, 1994). For example, the lower reach of the Nueces River where it crosses the Edwards (Balcones Fault Zone) Aquifer recharge zone has no baseflow (Fratesi and others, 2014). Lower reaches of Cibolo Creek lose flow between Boerne and Bulverde where the creek flows over the lower member of the Glen Rose Limestone (Ashworth, 1983). Conversely, Cibolo Creek gains water where it flows over the upper member of the Glen Rose Limestone (Guyton and Associates, 1958, 1970; Espey, Huston and Associates, 1989; LBG-Guyton Associates, 1995; Mace and others, 2000). Many perennial rivers have had brief episodes of no flow during droughts (Figure 4.4.2).

Useful in understanding gain/loss on rivers in the study area are synoptic streamflow measurements of the Nueces and Blanco rivers undertaken by a collaboration of the Edwards Aquifer Authority and the University of Texas Jackson School of Geosciences that was conducted as part of the Edwards Aquifer Authority Interformational Flow program (Figure 4.4.4 and Figure 4.4.5). Flow in the Nueces River (Figure 4.4.4) differs from flow in the Blanco River (Figure 4.4.5). The Blanco River is losing from its upland area until western Comal County. From that point downstream, the river is gaining. The transition occurs along a reach where the upper member of the Glen Rose is absent and the riverbed overlies the lower member of the Glen Rose Formation. The Blanco River is mostly gaining over the remaining reach located within the HCT Aquifer study domain. The Nueces River is more complex. It varies between gaining and losing over the entire reach where it was measured (Figure 4.4.4). Part of the variability in flow measurements is due to difficulty in obtaining accurate flow measurements due to the large quantity of gravel and alluvium present in the bed of the Nueces River.

4.4.2 Lakes and Reservoirs

Lakes and reservoirs in the area include Lake Buchanan, Inks Lake, Lake Travis, Lake Austin, Inks Lake, Lake LBJ, Lake Walter E. Long, Canyon Lake, Medina Lake, Calaveras Lake, Braunig Lake, and Amistad Reservoir (Figure 4.4.6). None of the lakes are naturally occurring. All are reservoirs that result from the damming of rivers. The largest reservoirs are gauged allowing the elevation of the water elevation to be recorded over time. Daily water elevations for the lakes in the study area that have historical measurements are included in Figure 4.4.7. Canyon Lake and Lake Travis have maintained approximately constant levels (+/- 20 feet) although Lake Travis had large declines during the drought of the 1950s, in the mid-1960s, and again in the 1970s (Figure 4.4.7). Lake Medina has much more variation in levels and has nearly been dry on a couple occasions (Espey, Huston, and Associates, 1989).

Conceptual Model Report for the Hill Country Trinity Aquifer
Groundwater Availability Model

Table 4.4.1 Summary statistics for automated baseflow separation filter. The baseflow fraction values are the fraction of the total long term discharge that is contributed by baseflow in the watershed upstream of the gauge location.

USGS Station	Baseflow Fraction Pass One	Baseflow Fraction Pass Two	Baseflow Fraction Pass Three	Number of Recessions Used	Baseflow Recession Constant	Baseflow Days
810464660	0.54	0.38	0.31	4	0.149	15.484
8148500	0.67	0.54	0.48	14	0.021	108.249
8150000	0.91	0.86	0.82	5	0.007	320.871
8150700	0.83	0.74	0.67	6	0.011	214.947
8150800	0.72	0.57	0.47	8	0.026	86.980
8151500	0.69	0.56	0.5	54	0.023	102.302
8152000	0.46	0.29	0.23	32	0.086	26.681
8152900	0.62	0.48	0.42	36	0.031	74.919
8153500	0.58	0.43	0.37	24	0.051	45.091
8154700	0.57	0.4	0.33	47	0.035	66.079
8155200	0.64	0.47	0.38	37	0.037	61.972
8155240	0.64	0.47	0.38	29	0.039	58.854
8158700	0.66	0.45	0.32	8	0.020	113.734
8158810	0.62	0.46	0.37	35	0.034	66.941
8158840	0.69	0.51	0.4	4	0.050	45.730
8158920	0.39	0.22	0.15	12	0.110	20.906
8165300	0.8	0.68	0.6	2	0.054	42.952
8165500	0.7	0.58	0.51	4	0.008	308.169
8166000	0.75	0.66	0.61	26	0.012	190.732
8166140	0.82	0.72	0.66	8	0.022	102.888
8166200	0.79	0.69	0.64	23	0.016	143.243
8167000	0.8	0.68	0.61	10	0.016	142.605
8167500	0.74	0.6	0.52	53	0.019	123.108
8167800	0.71	0.58	0.49	52	0.010	227.493
8171000	0.78	0.65	0.56	30	0.015	150.403
8178585	0.46	0.23	0.12	3	0.274	8.389
817887350	0.8	0.68	0.59	3	0.008	284.656
8178880	0.77	0.63	0.54	10	0.019	123.426
8179520	0.82	0.7	0.61	2	0.006	396.733
8180586	0.74	0.56	0.45	2	0.028	82.741
8181400	0.44	0.22	0.14	8	0.133	17.325
8183850	0.57	0.38	0.29	7	0.053	43.428
8183890	0.65	0.49	0.42	3	0.023	99.368

Conceptual Model Report for the Hill Country Trinity Aquifer
Groundwater Availability Model

Table 4.4.1 Continued.

USGS Station	Baseflow Fraction Pass One	Baseflow Fraction Pass Two	Baseflow Fraction Pass Three	Number of Recessions Used	Baseflow Recession Constant	Baseflow Days
8183900	0.63	0.47	0.4	19	0.046	50.587
818999010	0.92	0.87	0.83	3	0.005	427.889
8190000	0.77	0.62	0.52	11	0.010	225.016
8195000	0.83	0.71	0.63	34	0.009	258.244
8196000	0.68	0.53	0.46	67	0.016	141.018
8198000	0.73	0.58	0.48	4	0.022	107.184
8200000	0.67	0.5	0.42	57	0.021	110.687
8200977	0.56	0.35	0.25	2	0.100	23.053
8201500	0.76	0.6	0.5	9	0.033	70.599
8202450	0.58	0.36	0.25	2	0.060	38.401

Conceptual Model Report for the Hill Country Trinity Aquifer
Groundwater Availability Model

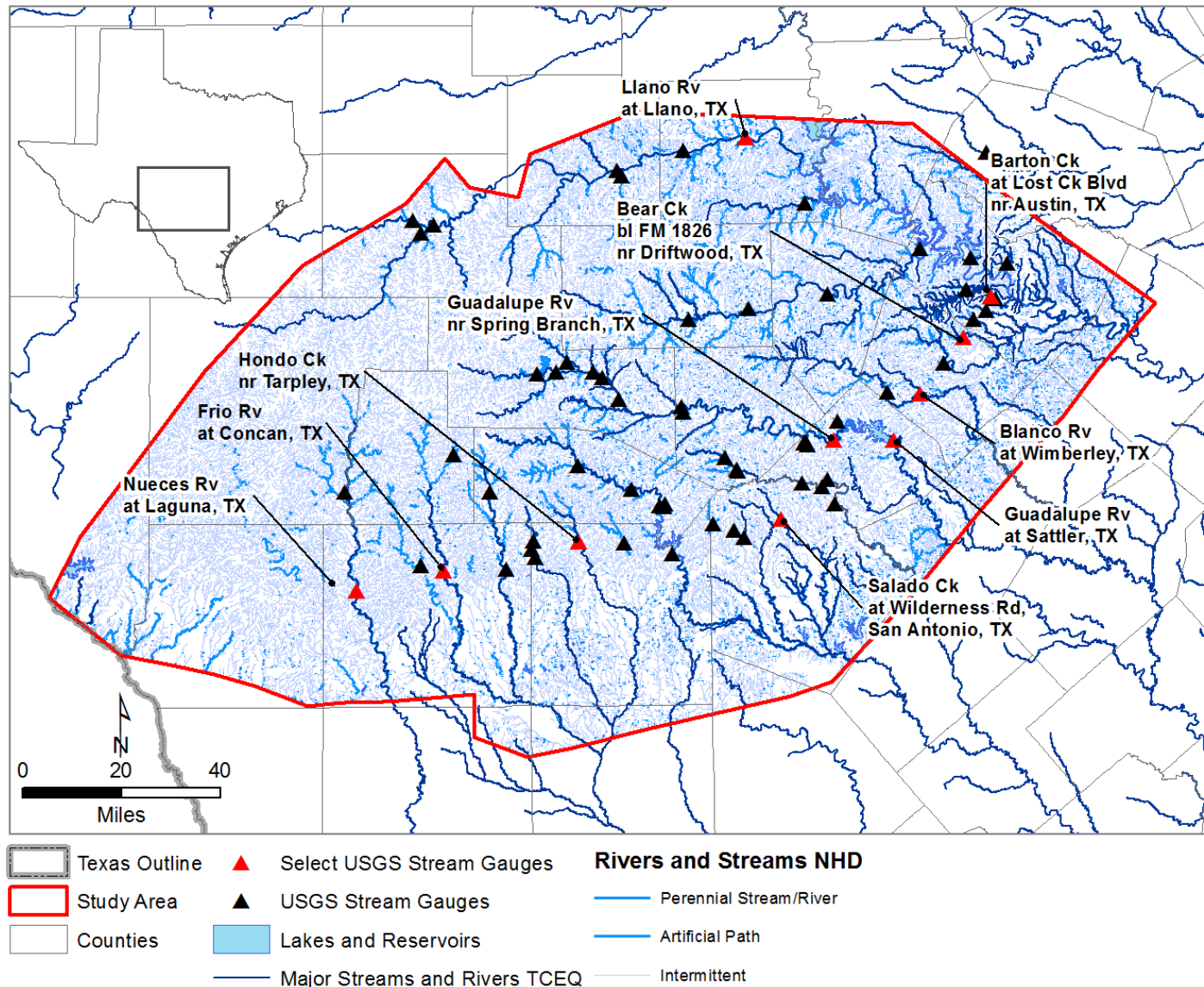

Figure 4.4.1 Locations of USGS Stream Gages in the study area. Gage locations with Hydrographs appearing in this report are indicated in red.

Conceptual Model Report for the Hill Country Trinity Aquifer
Groundwater Availability Model

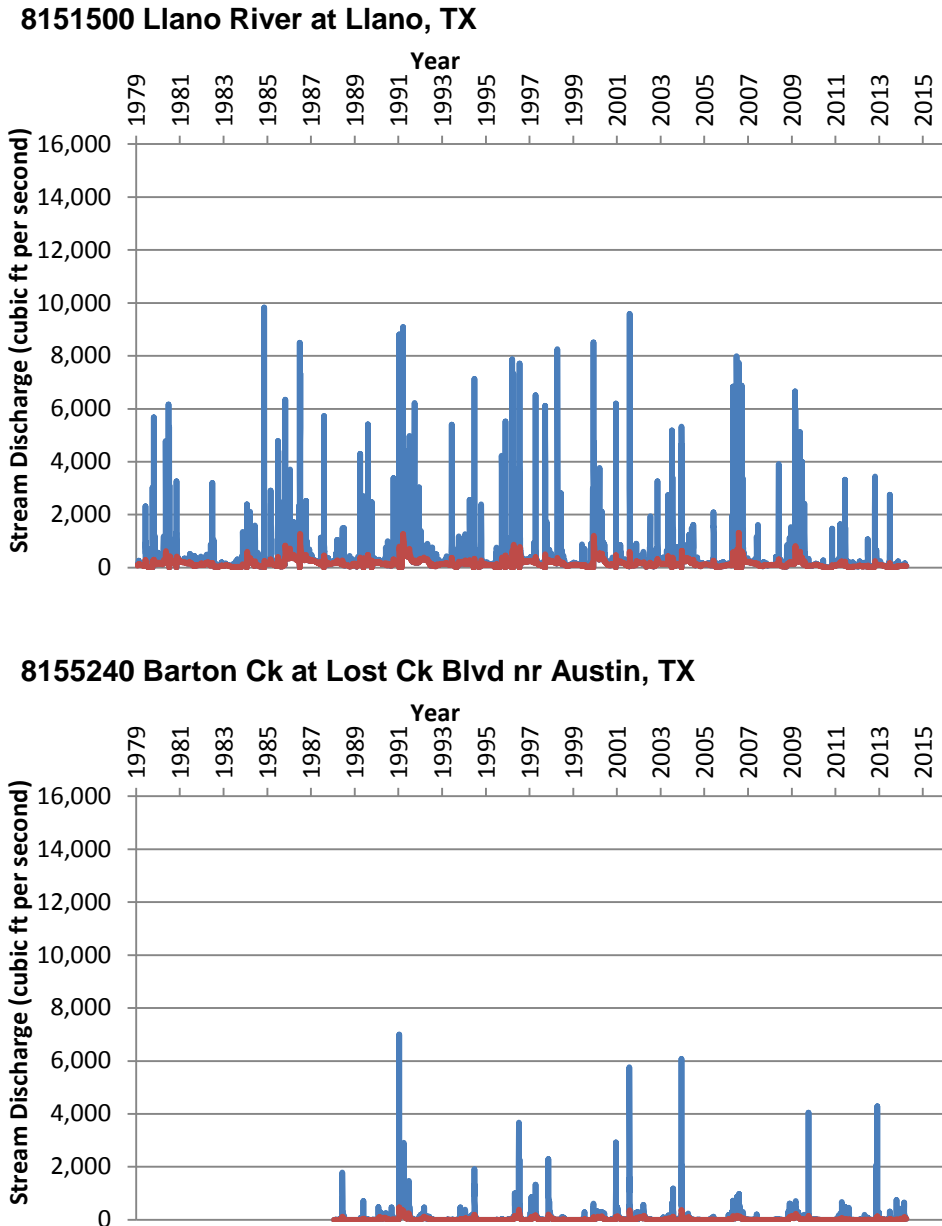
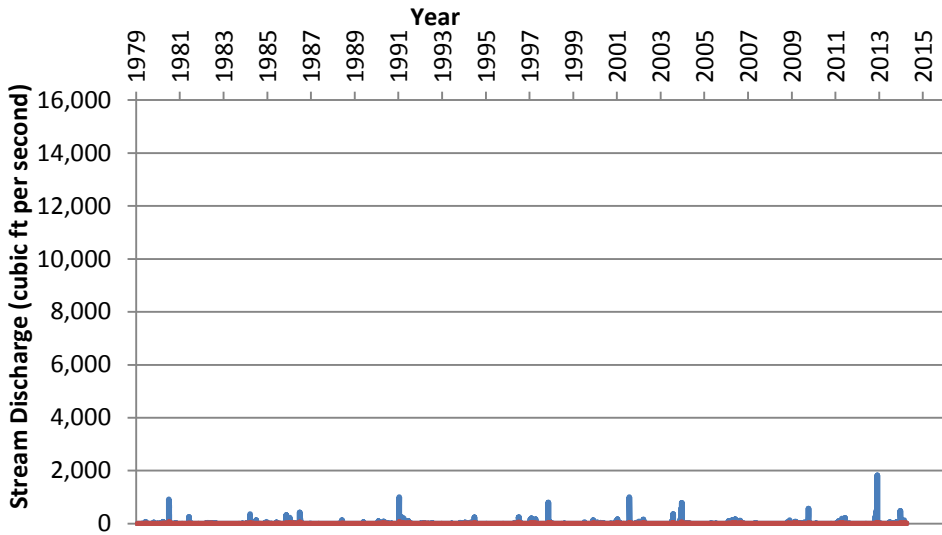

Figure 4.4.2 Stream Discharge hydrographs for selected gauging sites in the HCT study area. Blue lines indicate total stream discharge. Red line indicates baseflow fraction of discharge.

Conceptual Model Report for the Hill Country Trinity Aquifer
Groundwater Availability Model

8158810 Bear Ck bl FM 1826 nr Driftwood, TX



8171000 Blanco Rv at Wimberley, TX

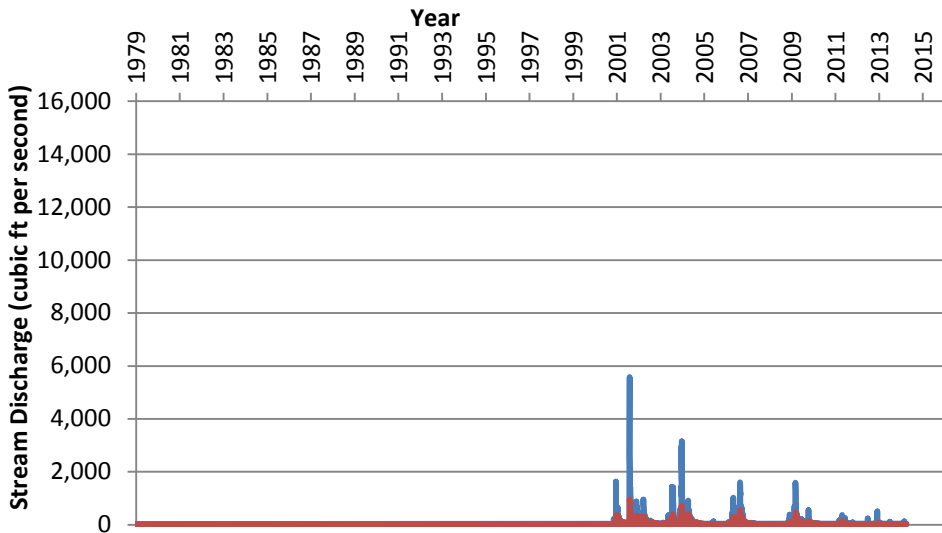
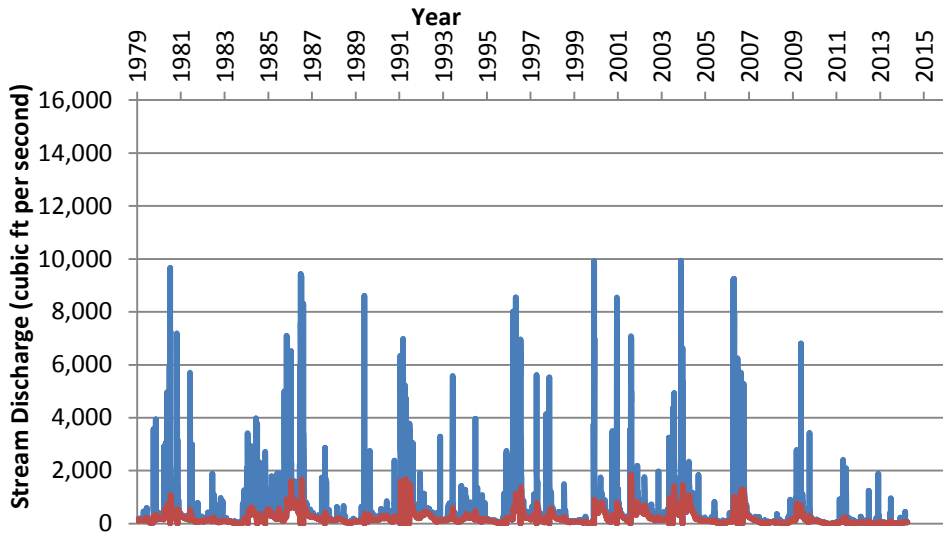

Figure 4.4.2 Continued.

Conceptual Model Report for the Hill Country Trinity Aquifer
Groundwater Availability Model

8167500 Guadalupe River nr Spring Branch, TX



8167800 Guadalupe Rv at Sattler, TX

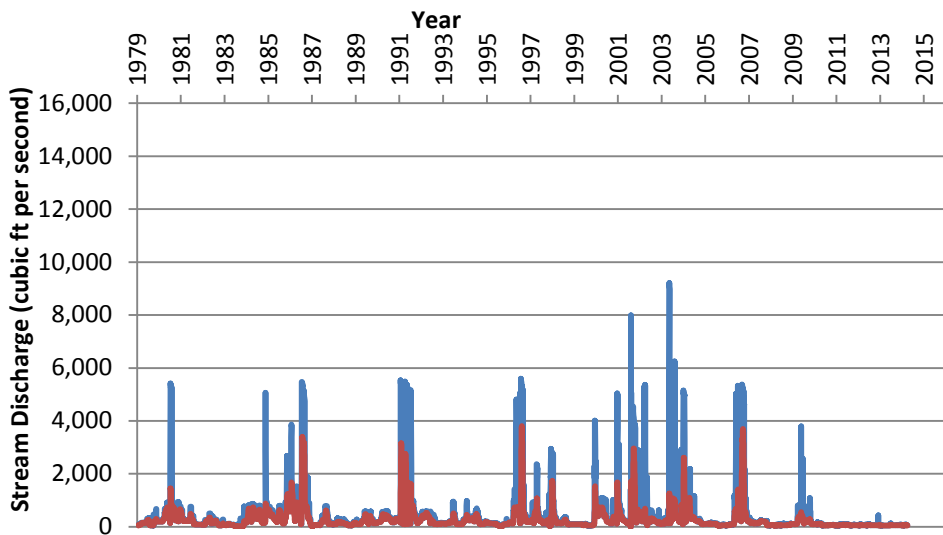
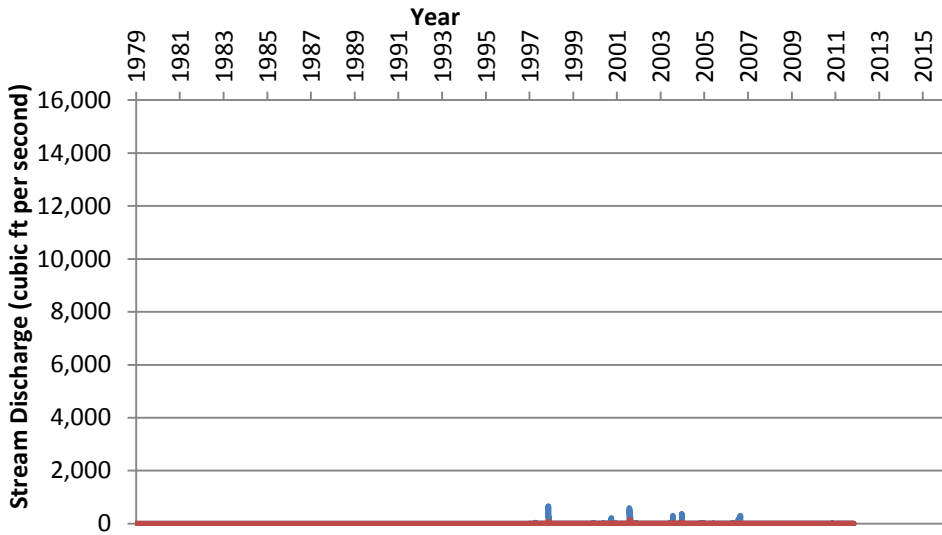

Figure 4.4.2 Continued.

Conceptual Model Report for the Hill Country Trinity Aquifer
Groundwater Availability Model

8178585 Salado Ck at Wilderness Rd, San Antonio, TX



8200000 Hondo Ck nr Tarpley, TX

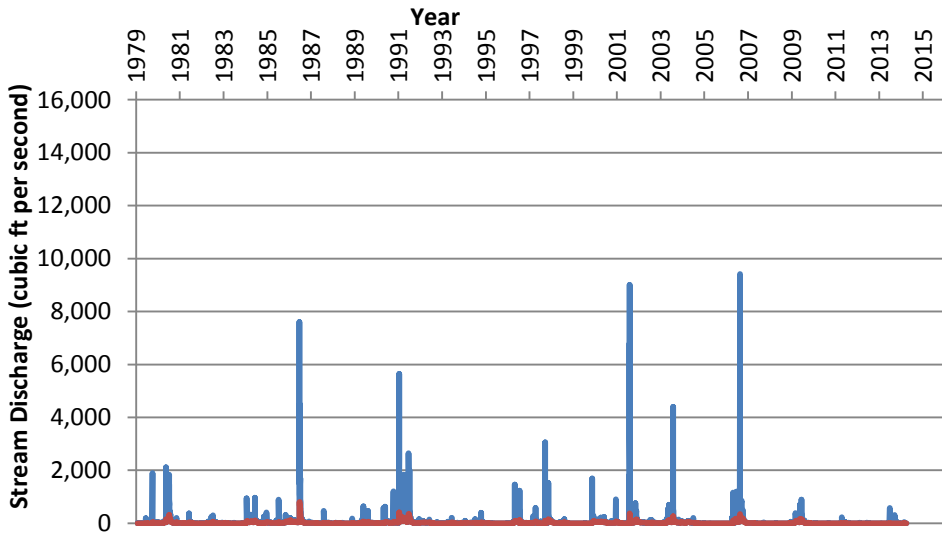
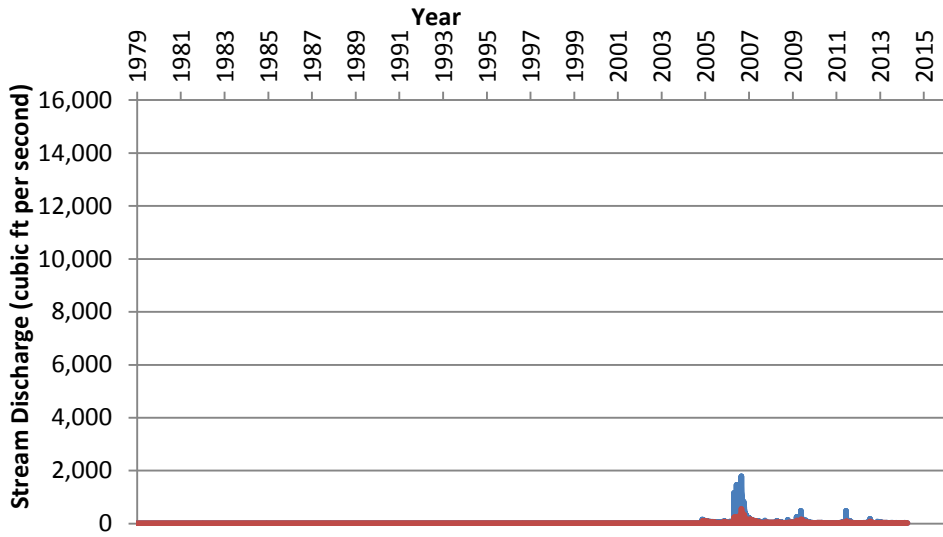

Figure 4.4.2 Continued.

Conceptual Model Report for the Hill Country Trinity Aquifer
Groundwater Availability Model

8190000 Nueces River at Laguna, TX



8195000 Frio Rv at Concan, TX

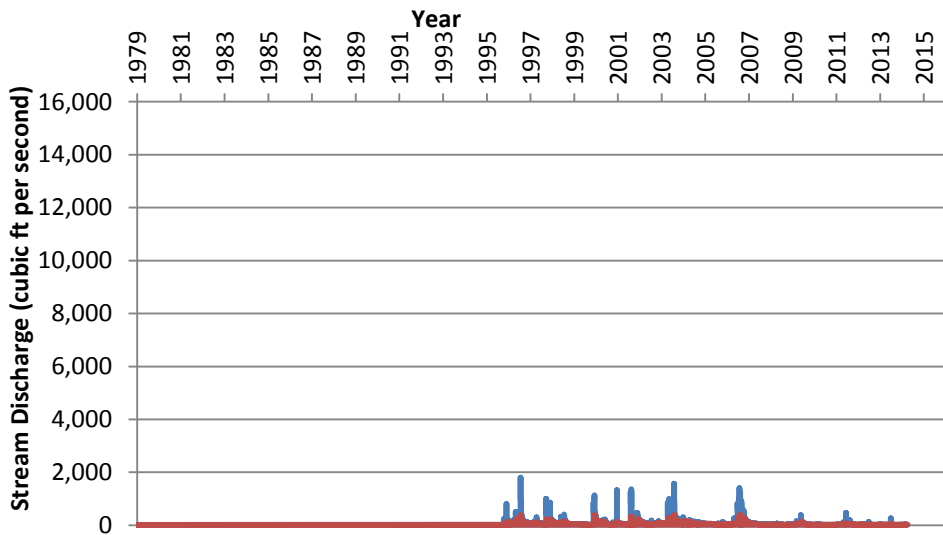

Figure 4.4.2 Continued.

Conceptual Model Report for the Hill Country Trinity Aquifer
Groundwater Availability Model

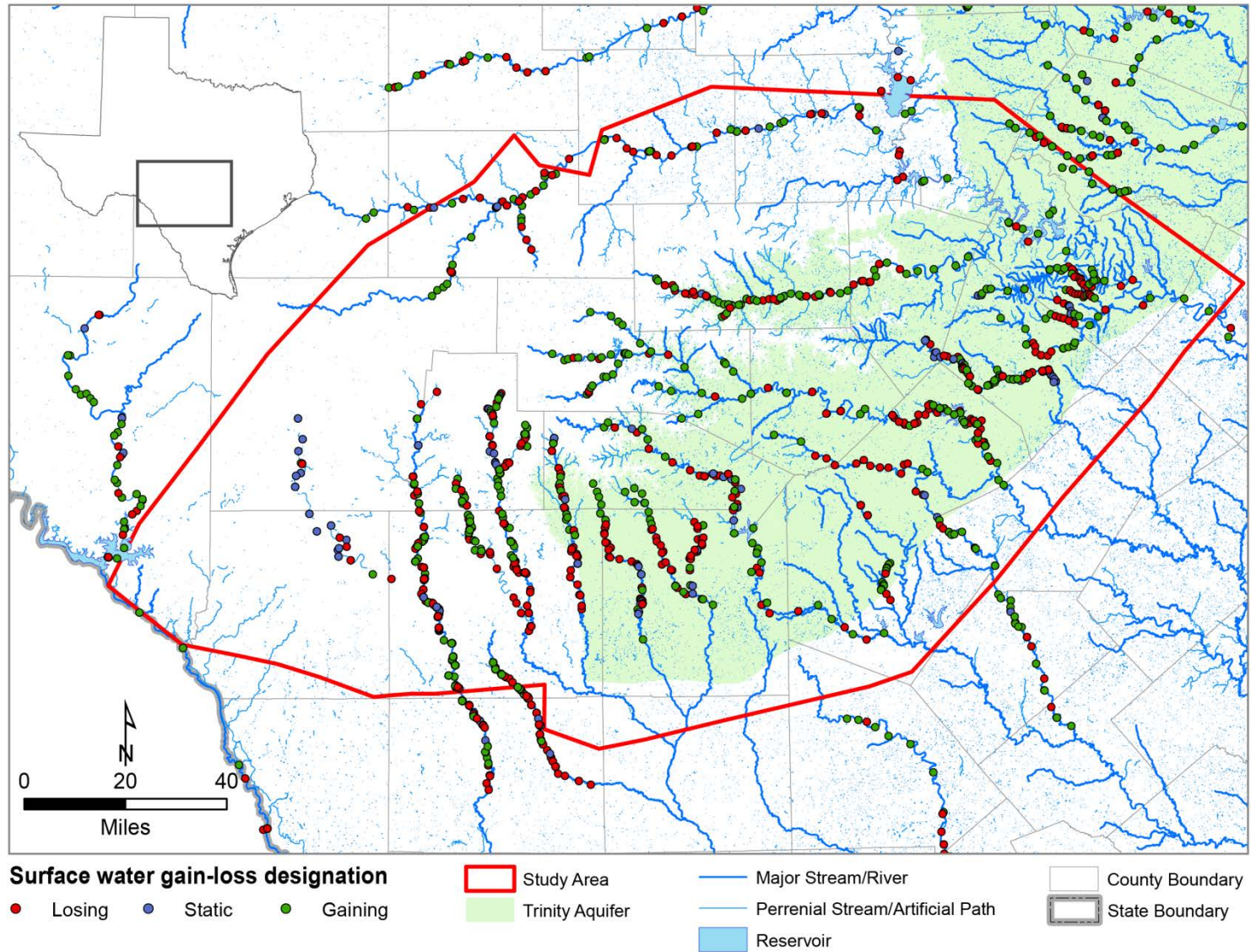

Figure 4.4.3 Gain/loss measurements in the study area (Slade and others, 2002 and Gary, 2018).

Conceptual Model Report for the Hill Country Trinity Aquifer
Groundwater Availability Model

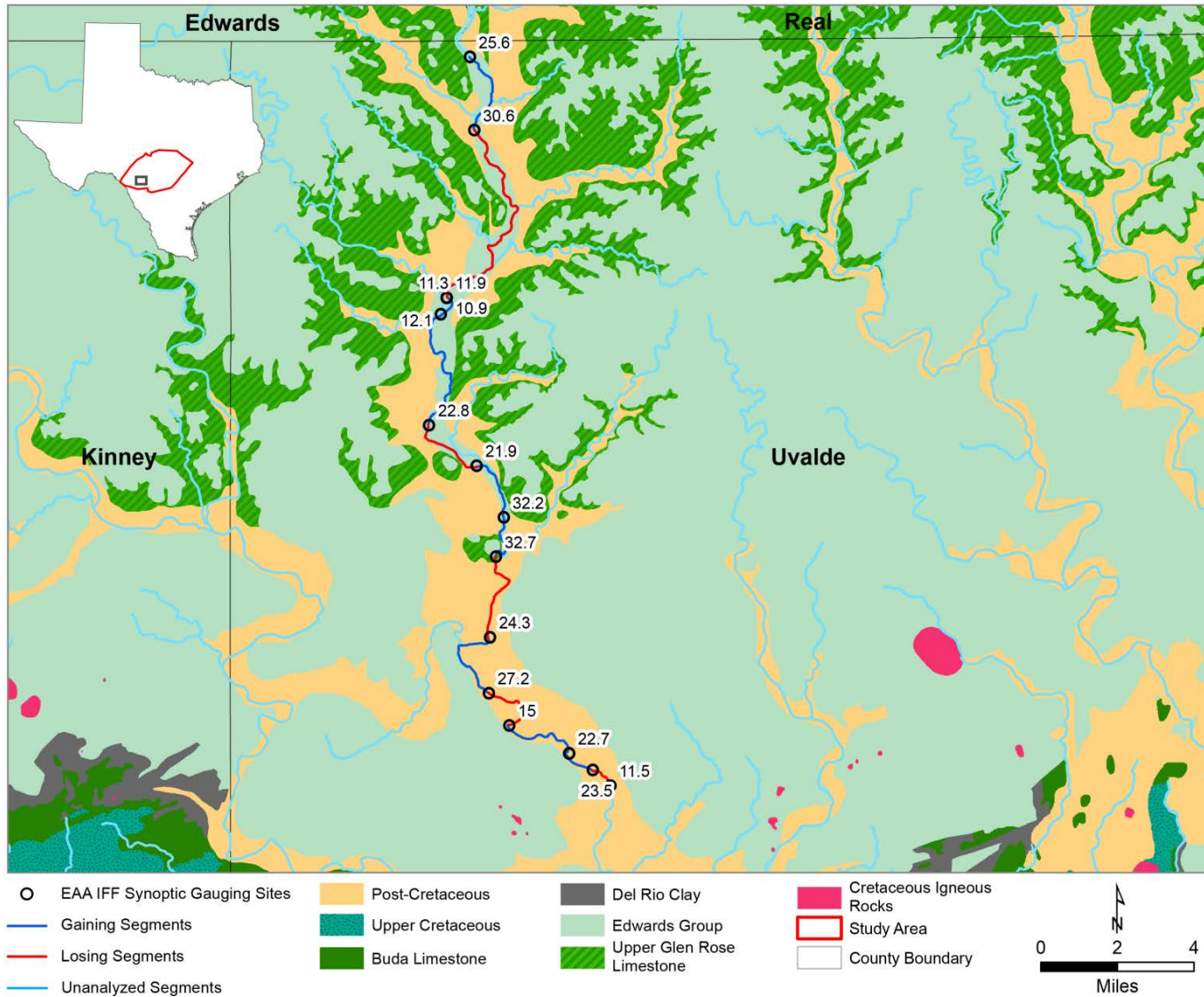

Figure 4.4.4 Synoptic gain/loss measurements of the Nueces River (cubic feet per second) (Gary, 2018).

Conceptual Model Report for the Hill Country Trinity Aquifer
Groundwater Availability Model

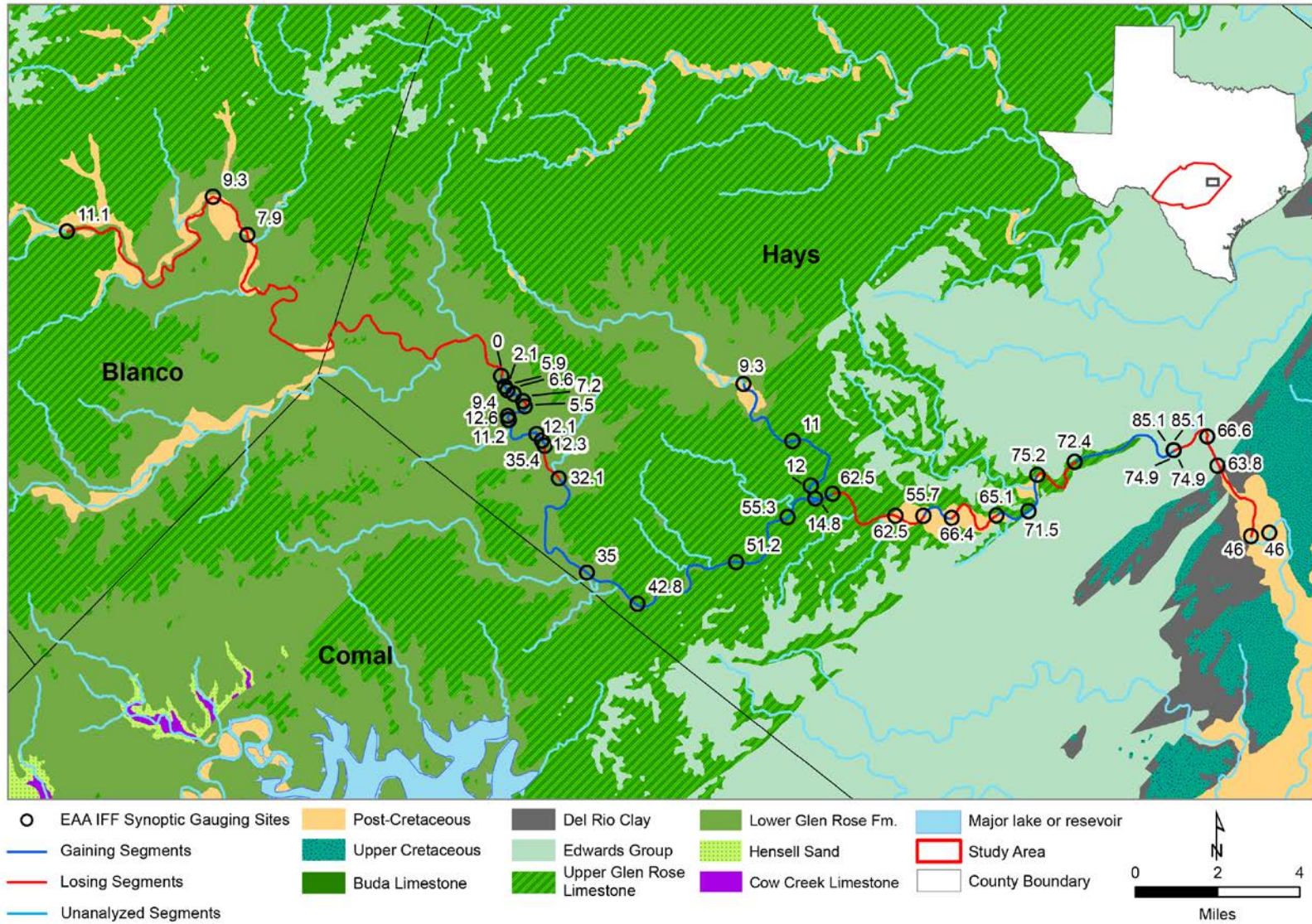

Figure 4.4.5 Synoptic gain/loss measurements of the Blanco River (cubic feet per second)(Gary, 2018).

Conceptual Model Report for the Hill Country Trinity Aquifer
Groundwater Availability Model

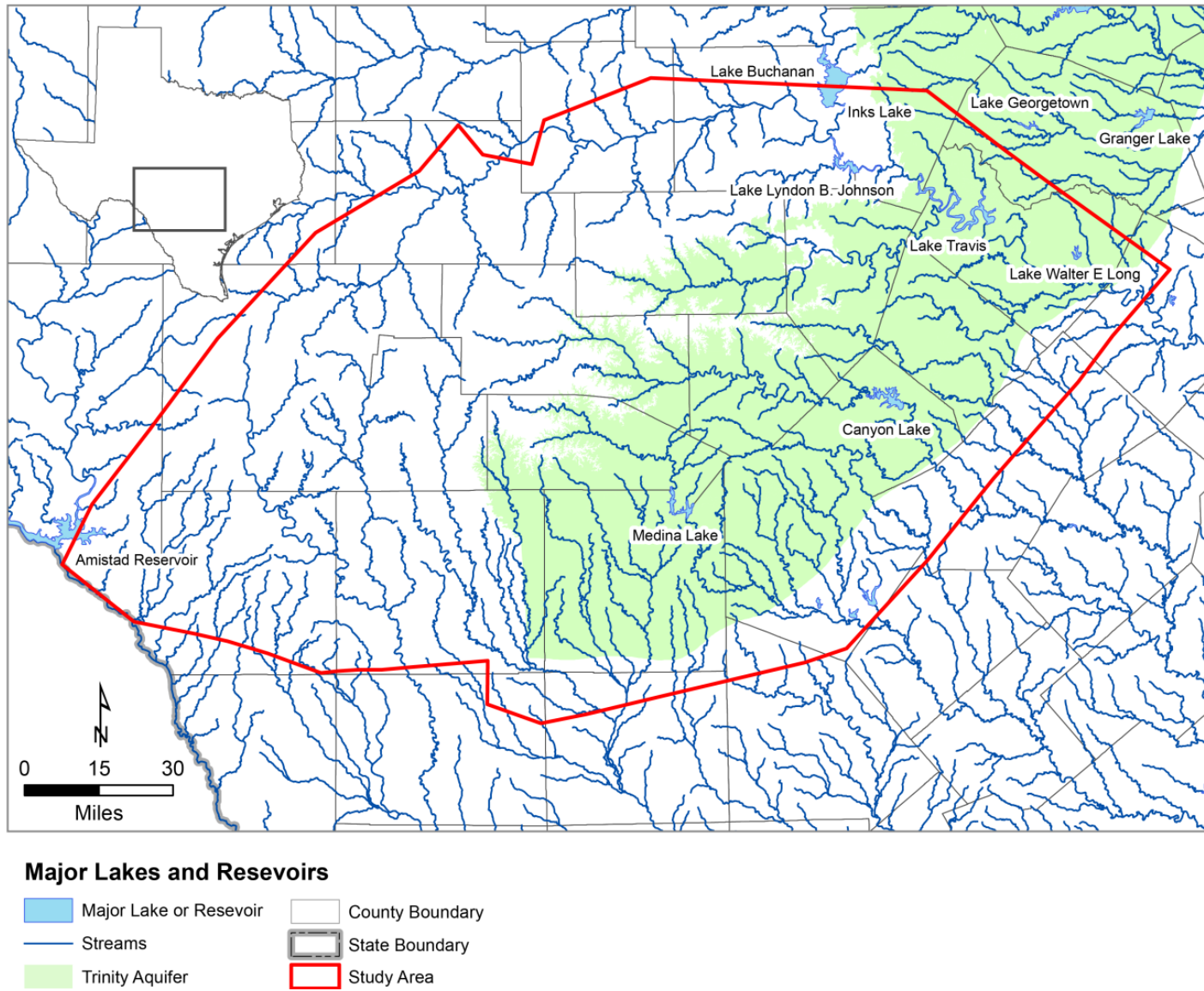

Figure 4.4.6 Major lakes and reservoirs in the study area.

Conceptual Model Report for the Hill Country Trinity Aquifer
Groundwater Availability Model

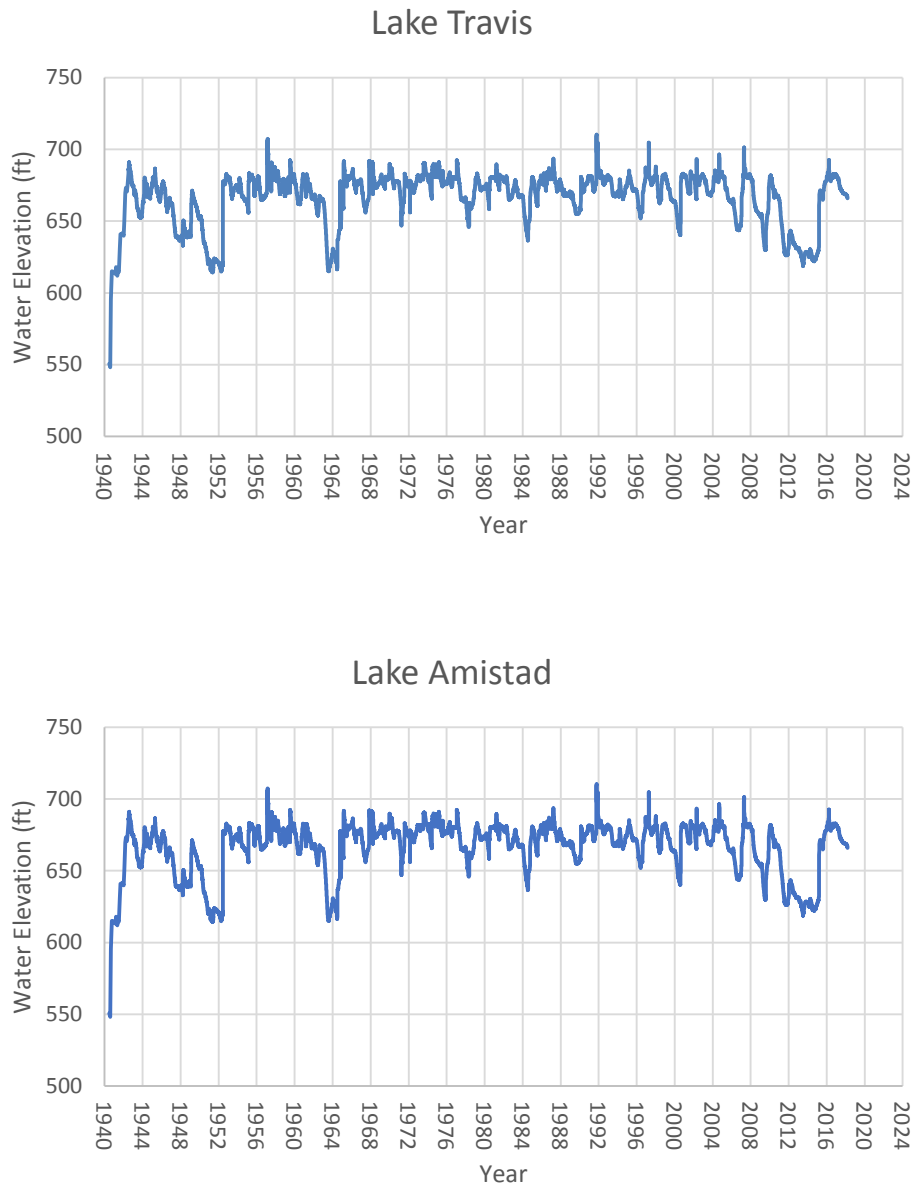

Figure 4.4.7 Hydrographs of Major Lakes in the Study Area 1940-2018.

Conceptual Model Report for the Hill Country Trinity Aquifer
Groundwater Availability Model

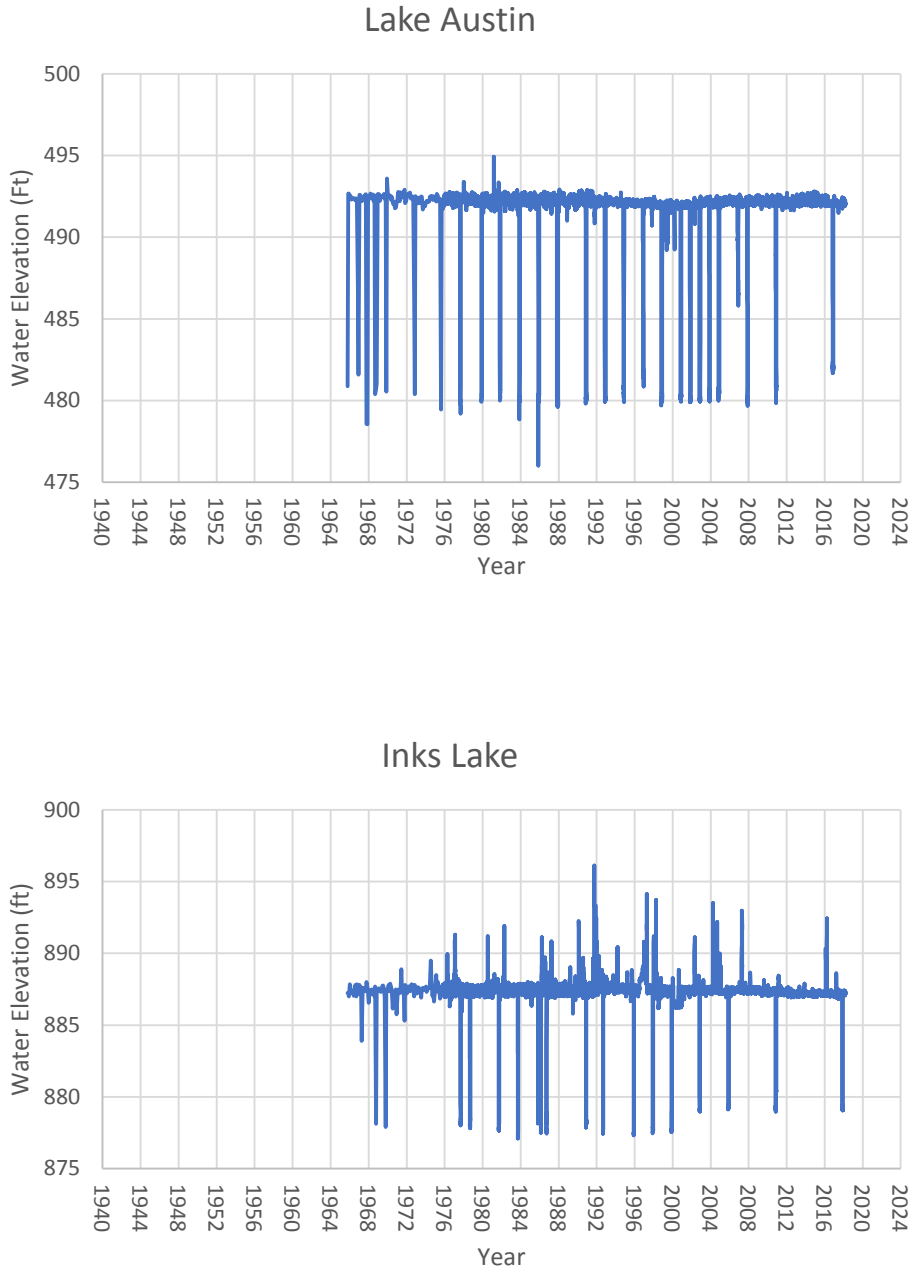

Figure 4.4.7 Continued.

Conceptual Model Report for the Hill Country Trinity Aquifer
Groundwater Availability Model

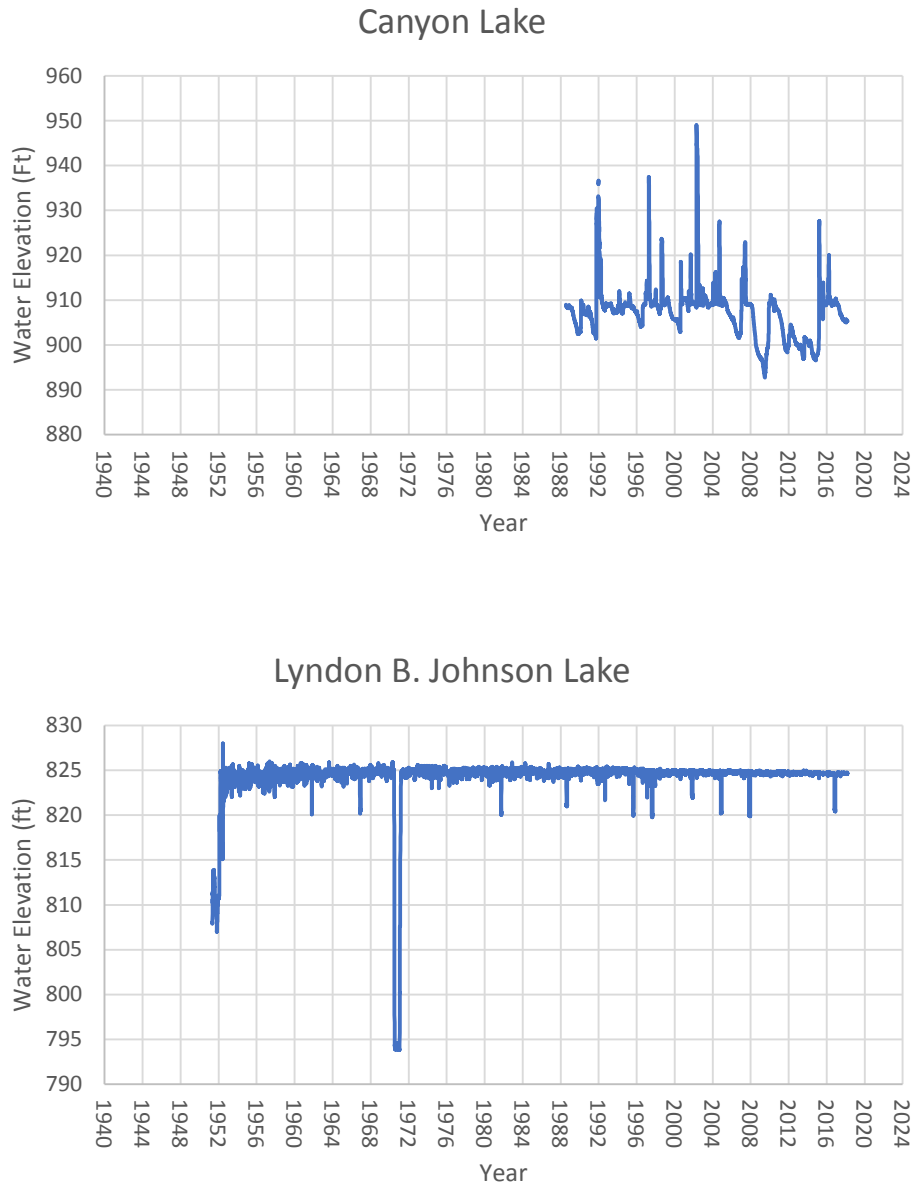

Figure 4.4.7 Continued.

Conceptual Model Report for the Hill Country Trinity Aquifer
Groundwater Availability Model

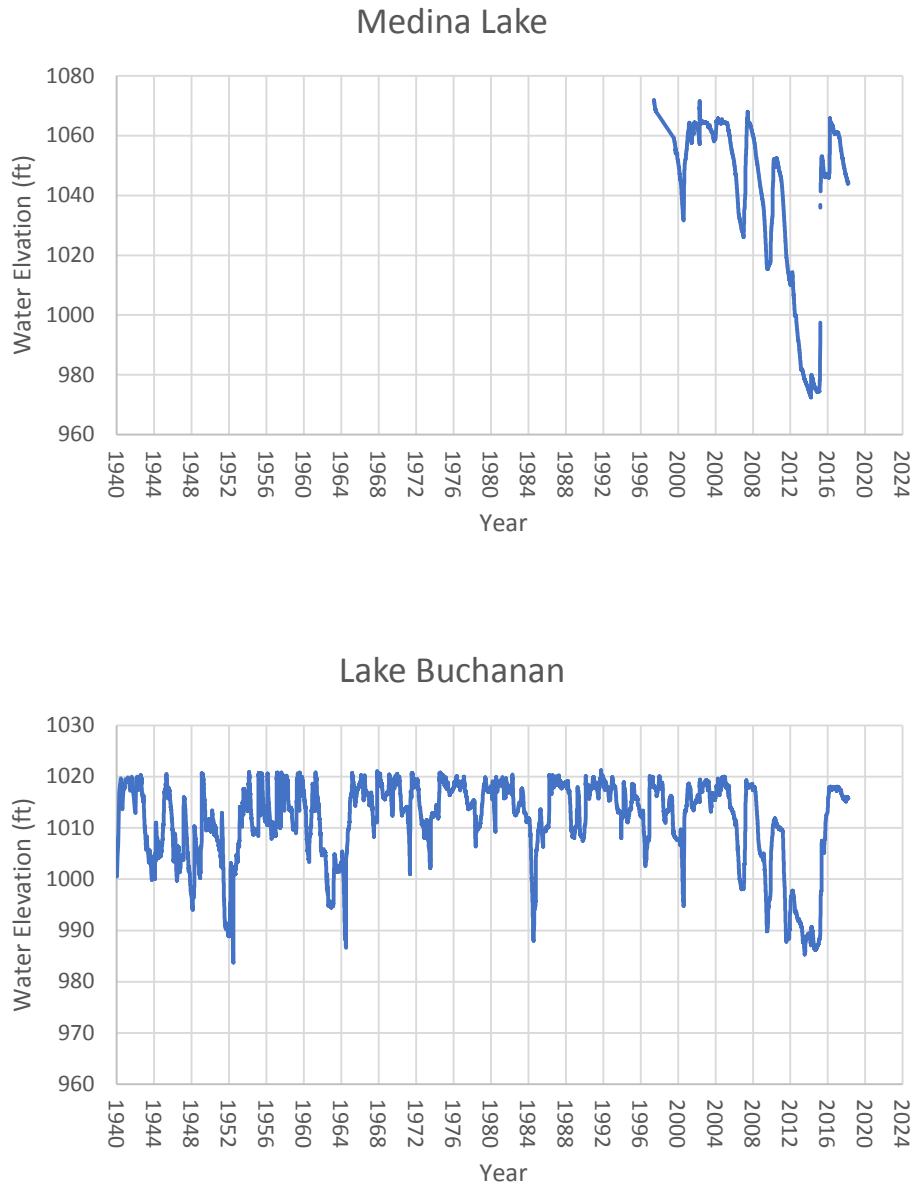

Figure 4.4.7 Continued.

4.5 Hydraulic Properties

Hydraulic properties, which describe the ability of an aquifer to transmit and store groundwater, can vary greatly depending on the individual characteristics of an aquifer. Several hydraulic properties are used to describe groundwater flow in aquifers. The properties discussed here are hydraulic conductivity, transmissivity, specific capacity, storativity, specific storage, and specific yield. Each of these terms is briefly described below.

Hydraulic Conductivity – The measure of the ease with which groundwater can flow through an aquifer. Higher hydraulic conductivity indicates that the aquifer will allow more water movement under the same hydraulic gradient. Units for hydraulic conductivity may be expressed in feet per day or gallons per day per square foot.

Transmissivity – This term is closely related to hydraulic conductivity and refers to the product of the hydraulic conductivity times the effective aquifer thickness. Transmissivity describes the ability of groundwater to flow through the entire thickness of an aquifer. As the thickness of the aquifer increases, the transmissivity increases for a given hydraulic conductivity. Units for transmissivity may be expressed in square feet per day or gallons per day per foot.

Specific Capacity – This is the rate of water that can be produced from a well per unit length of drawdown. This parameter depends on both the efficiency of a well and the productivity of the aquifer. Specific capacity is expressed in terms of gallons per minute per foot of drawdown in the well.

Storativity – The volume of water that an aquifer releases from storage under a unit decline in hydraulic head. For a confined aquifer, the storativity is equal to the product of specific storage and aquifer thickness. In an unconfined aquifer, the aquifer storativity is equal to the sum of the specific yield and the product of specific storage and aquifer thickness. Storativity can be expressed as a dimensionless parameter, or storage coefficient.

Specific Yield – The measure of the amount of water that an unconfined aquifer releases from storage per unit surface area of aquifer per unit decline in water table due to the drainage of the pore spaces in the aquifer by gravity. Specific yield is a dimensionless parameter.

Specific Storage – The measure of the amount of water that a unit volume of a confined aquifer releases from storage per unit decline in head, due to changes in the density of the water from reduced hydraulic pressure and to changes in the arrangement and bulk density of the aquifer matrix. Specific storage can be influenced by lithology and depth of burial. Specific storage can be expressed per foot.

The assignment of values for aquifer hydraulic properties is an important aspect in numerical modeling because adjusting those values is typically an integral part of model calibration. Values for the hydraulic properties of the HCT Aquifer were obtained from the literature and estimated from observed data. The following subsections describe the data sources and summarize the data from those sources, the estimation of hydraulic conductivity from specific capacity measurements, the estimated spatial distribution of transmissivity and horizontal hydraulic conductivity, vertical hydraulic conductivity, and specific yield.

4.5.1 Data Sources for Transmissivity and Specific Capacity Measurements

Multiple sources were queried for transmissivity and specific capacity measurement data for the Trinity hydrostratigraphic units in the current study area. The compiled point measurements were

Conceptual Model Report for the Hill Country Trinity Aquifer
Groundwater Availability Model

assigned to the current report's hydrostratigraphic units based on their well depth and screen information, where available. Well assignments were made according to the methodology described in Section 4.2. Data sources for point measurements of transmissivity and specific capacity measurements included:

- TWDB compilations of pumping test analyses based on data in the TWDB database (Myers, 1969; Christian and Wuerch, 2012)
- A compilation of pumping tests from county groundwater availability studies (Daniel B. Stephens and Associates, 2006)
- Pumping test data received from groundwater conservation districts in the study area, including individual records and a compilation of aquifer tests from Barton Springs Edwards Aquifer Conservation District (Hunt and others, 2010)
- The Edwards-Trinity (Plateau) Aquifer GAM (Anaya and Jones, 2009) database, which includes aquifer test data from the TWDB groundwater database and the Texas Commission on Environmental Quality (TCEQ) database.
- Drawdown, yield, and duration data for specific capacity tests from the TWDB groundwater database remarks table (TWDB, 2017b) and the TWDB submitted drillers' report database (2017d) and the TWDB BRACS database (TWDB, 2017a).

Two TWDB publications that compiled and analyzed aquifer test data in Texas (Myers, 1969; Christian and Wuerch, 2012) were queried. The Myers (1969) dataset includes 22 tests and the Christian and Wuerch (2012) dataset includes 30 tests for wells within the study area. These wells were assigned to the current report's hydrostratigraphic units based on their well depth and screen information.

Daniel B. Stephens and Associates (2006) compiled subdivision pumping tests conducted in 12 counties, most of which fall wholly or partially within the current study area. This dataset includes 72 aquifer tests, mostly from counties that require Groundwater Availability Studies (GwAS) as part of the subdivision platting process. Of these, about sixty aquifer tests fell within the study area and could be assigned to hydrostratigraphic units based on their well depth and screen information. An additional three aquifer tests fall within the study area but do not have location information and so could not be assigned to the current report's hydrostratigraphic units. The Edwards-Trinity (Plateau) Aquifer GAM (Anaya and Jones, 2009) database includes 7 TWDB pumping tests that fall within the current study area. Of these, four wells overlap with the Christian and Wuerch (2012) dataset. The database also includes about 400 hydraulic conductivity values derived from specific capacity test data that fall within the current study area. These specific capacity values were not considered as a separate dataset, as they overlapped with the specific capacity dataset created for the current study using the TWDB groundwater database remarks table (TWDB, 2017b) (see below).

The Edwards-Trinity (Plateau) Aquifer GAM (Anaya and Jones, 2009) database also includes an additional 700 hydraulic conductivity values calculated from specific capacity data in Texas Commission on Environmental Quality well records. These values are shown by Texas Commission on Environmental Quality grid-block (Figure 4.5.1). Note that, if more than one well is present in a grid-block, the value represents the geometric mean of those wells. The figure only shows values for wells assigned to the Trinity model layer in the Edwards-Trinity (Plateau) Aquifer GAM. These hydraulic conductivity values could not otherwise be used directly in the

current analysis as they do not include the aquifer in which the wells are completed and locations are identified only at the Texas Commission on Environmental Quality grid-block level, which is a 2.5-minute by 2.5-minute area. Therefore, the locations of these wells were considered too uncertain to re-assign them to the current project's hydrostratigraphic units.

Barton Springs Edwards Aquifer Conservation District compiled aquifer test data in Hays and Trinity counties (Hunt and others, 2010). This dataset includes about 96 tests compiled from County Water Availability Studies, district hydrogeologic reports and the TWDB groundwater well database. About 23 of these tests appear to be duplicates of the Daniel B. Stephens and Associates (2006) dataset. Several recent documents for individual aquifer tests were also provided by Barton Springs Edwards Aquifer Conservation District and Blanco-Pedernales Groundwater Conservation District. This yielded about 25 additional data values.

The TWDB groundwater database (TWDB, 2017b), the TWDB submitted drillers' report database (TWDB, 2017d), and the TWDB BRACS database (TWDB, 2017a) were queried for drawdown, yield, and duration data for specific capacity tests. Data from these wells were not included if test data was missing, drawdown was zero, or if the well was bailed. This yielded over 3,000 total specific capacity data values in the current study area.

4.5.2 Literature Sources for Transmissivity and Hydraulic Conductivity Values

In addition to sources of hydraulic property measurements, other literature sources were also reviewed, including previous groundwater models. These did not yield additional field measurement values but were useful for determining reasonable hydraulic property ranges for the current study. Barker and Ardis (1996) provide insight into hydraulic property trends in the study area. They note that hydraulic conductivity changes spatially within each Trinity hydrostratigraphic unit. In general, they note that downgradient subcrops become less permeable due to stable mineral evolution, whereas upgradient outcrops become more permeable due to evaporite leaching and unstable carbonate constituents. Examples of these permeable features include cavernous areas and sinkholes in the Glen Rose Limestone outcrop and shallow subcrop (particularly in northern Bexar and southwestern Comal counties), highly permeable quartzose clastic facies in the updip portion of the Hensell Sand and dissolution pores in the Cow Creek Limestone outcrop areas (Barker and Ardis, 1996).

A groundwater model in North Medina County (Young and others, 2005) produced a calibrated hydraulic conductivity value of 0.5 feet per day for the Upper Trinity hydrostratigraphic unit and a hydraulic conductivity distribution that averaged 1.6 feet per day for the Middle Trinity hydrostratigraphic unit. The Edwards-Trinity (Plateau) Aquifer GAM (Anaya and Jones, 2009) used an initial hydraulic conductivity value of 2.5 feet per day in the southern part of the Trinity model layer that overlaps the current study area. A re-calibration of this GAM (Young and others, 2010) produced calibrated hydraulic conductivities of 2.1 feet per day in the southern part of the Trinity Aquifer model layer that overlaps the current study area. A groundwater model of the Lower Trinity Aquifer in Bandera County (LBG-Guyton Associates, 2008) produced a calibrated hydraulic conductivity range of 15 feet per day in the Lower Trinity hydrostratigraphic unit in the Kerrville area, 0.16 feet per day near the City of Bandera, and 0.1 feet per day in the area between them. Based on aquifer pumping test data in Barton Springs Edwards Aquifer Conservation District, Hunt and others (2010) estimated a median hydraulic conductivity value of about 5 feet per day for the Middle Trinity Aquifer and about 1.3 feet per day in the Lower Trinity Aquifer. Data were sparse in the Upper Trinity Aquifer and they only reported two data

Conceptual Model Report for the Hill Country Trinity Aquifer
Groundwater Availability Model

points of 0.058 and 0.095 feet per day. The previous HCT Aquifer GAM (Jones and others, 2011) produced calibrated hydraulic conductivity values that averaged 10.4 feet per day for the Upper Trinity hydrostratigraphic unit, 8.8 feet per day for the Middle Trinity hydrostratigraphic unit, and 4.4 feet per day for the Lower Trinity hydrostratigraphic unit. Oliver and Pinkard (2018) estimated hydraulic conductivity values by calibrating an analytic-element model to match aquifer test data in Hays County. In this model, the calibrated hydraulic conductivity value was 0.001 feet per day for the upper member of the Glen Rose hydrostratigraphic unit, 0.25 feet per day for the lower member of the Glen Rose hydrostratigraphic unit, 1×10^{-4} feet per day for the Hensell Formation, 4 feet per day for the Cow Creek Limestone, and 1×10^{-7} feet per day for the Hammett Shale.

Most literature sources only provided hydraulic conductivity values so only a few transmissivity estimates were available for the Trinity hydrostratigraphic units. Based on interpretation of aquifer pumping tests, Ashworth (1983) estimated an average transmissivity value of about 227 square feet per day in the Lower Trinity Aquifer and about 1,337 square feet per day in the Middle Trinity Aquifer. No estimate is provided for the Upper Trinity Aquifer, but Ashworth (1983) does note that transmissivity in this aquifer is “expected to be substantially lower with respect to the lower and middle Trinity.” Based on aquifer pumping test data in Barton Springs Edwards Aquifer Conservation District, Hunt and others (2010) estimated a median transmissivity value of about 19 square feet per day for the Upper Trinity Aquifer, about 304 square feet per day for the Middle Trinity Aquifer, and about 200 square feet per day in the Lower Trinity Aquifer.

4.5.3 Analysis of Transmissivity Data

Hydraulic property data values were only considered in the current analysis if there was sufficient information for them to be assigned to the current study’s hydrostratigraphic units. Well assignments were made according to the methodology described in Section 4.2 and were only used for the current analysis if they were fully completed in only one hydrostratigraphic unit. Table 4.5.1 summarizes the hydraulic property data available for each hydrostratigraphic unit. As illustrated by the table, while hydraulic conductivity and transmissivity data are scarce, specific capacity data are abundant. The spatial distribution of available transmissivity measurements from long-term pumping tests is shown in Figure 4.5.2 by hydrostratigraphic unit. Many of these fall in Hays County, which is fast-growing and requires water availability studies for new subdivisions. While most of the counties in the eastern portion of the study area have at least a few pumping tests for the Trinity hydrostratigraphic units, the western portion of the study area has only one test in Kimble County.

The spatial distribution of available specific capacity estimates is shown in Figure 4.5.3 by hydrostratigraphic unit. The majority of the available specific capacity data are for the Middle Trinity hydrostratigraphic unit in the central portion of the aquifer in Kerr, Kendall, Comal, Hays, Travis, eastern Bandera counties and the northern portion of Uvalde, Medina and Bexar counties. Upper Trinity hydrostratigraphic unit specific capacity values are less common in the central portion of the study area, although there is a cluster near the Edwards (Balcones Fault Zone) region in Comal County. Most of the specific capacity data available in the Edwards-Trinity (Plateau) region, including western Kerr County and Real, Edwards, and Val Verde counties, are in the Upper Trinity hydrostratigraphic unit. Lower Trinity hydrostratigraphic unit

specific capacity values are mostly located in the central portion of the study area, with most clustered near the (Balcones Fault Zone) region, especially in Comal County.

4.5.4 Calculation of Transmissivity from Specific Capacity

Field-scale hydraulic conductivity can be estimated from various types of aquifer performance tests, including slug tests (local near-well estimate), specific capacity tests (relatively near-well estimate), and multi-hour to multi-day aquifer pumping tests (integrated estimate over radius of influence, the size of which depends on the duration of the test). Results from aquifer pumping tests are most appropriate for estimating hydraulic conductivity for use in regional groundwater models as they stress a larger area of the aquifer than do slug and specific capacity tests. In addition, results from specific capacity tests are dependent on the efficiency of the well as well as properties of the aquifer, making them less useful than pumping tests for parameterization of regional-scale groundwater models. However, specific capacity is relatively easy to measure, requiring only the pumping rate and drawdown, and is commonly reported for wells. Aquifer pumping tests, on the other hand, are much more time consuming and expensive to conduct and interpret than are specific capacity tests.

Because high-quality data from multi-day aquifer pumping tests are scarce for the HCT Aquifer, but a large volume of specific capacity data are available, a methodology was developed to estimate transmissivity from the specific capacity data. An aquifer-specific relationship between transmissivity and specific capacity can be developed using both types of data from a single well. Using paired transmissivity/specific capacity measurements, Mace (2001) developed empirical relationships for the Glen Rose and Cow Creek formations (representing fractured carbonate) and for the Hensell and Hosston formations (representing sandstone). Figure 4.5.4, Figure 4.5.5, and Figure 4.5.6 show the transmissivity/specific capacity pairs available for the Upper Trinity, Middle Trinity and Lower Trinity hydrostratigraphic units, respectively, compared to the Mace (2001) empirical relationships for the Glen Rose/Cow Creek and the Hensell/Hosston formations. Due to the limited sample size, it is not clear which of the Mace (2001) empirical relationships provides the best fit to the transmissivity/specific capacity pairs.

Because the comparison of the data for each hydrostratigraphic unit to existing empirical relationships for other aquifers did not provide a definitive match, the analytical approach presented in Mace (2001) was used to estimate transmissivity from the available specific capacity for the aquifer. According to Mace (2001), the preferred analytical approach for establishing a relationship between specific capacity and transmissivity is based on the Theis non-equilibrium equation (Theis and others, 1963):

$$S_c = \frac{4\pi T}{\left[\ln\left(\frac{2.25Tt}{r^2 S}\right) \right]} \quad (4.5.1)$$

where:

- S_c = specific capacity,
- T = aquifer transmissivity,
- t = pumping time,
- r = well radius, and
- S = aquifer storativity.

Conceptual Model Report for the Hill Country Trinity Aquifer
Groundwater Availability Model

Equation 4.5.1 cannot be solved directly for transmissivity, so it was solved iteratively using Microsoft Excel. For wells with no reported well radius, an assumed well radius was used. This value was calculated from the wells with a reported well radius and was about 2.5 inches for the Upper Trinity hydrostratigraphic unit and 3 inches for the Middle and Lower Trinity hydrostratigraphic units. As suggested by Mace (2001), data for wells with no recorded pumping duration and wells where the type of specific capacity test were recorded as “bailed” were not used. Aquifer storativity for the calculation was assumed to be 1.2×10^{-5} for the Upper Trinity, 2.0×10^{-4} for the Middle Trinity, and 1.3×10^{-4} for the Lower Trinity hydrostratigraphic units based on literature values (Section 4.5.7).

If only a small portion of the aquifer thickness is screened, the resulting transmissivity value calculated from Equation 4.5.1 will not be representative of the entire aquifer thickness (Mace, 2001). This “partial penetration” can be addressed through mathematical methods that correct for the short screen or by only considering wells that are screened over a large percentage of the aquifer thickness. However, implementing these methods requires that both the screen length and the aquifer thickness at wells be known. Unfortunately, many wells in this specific capacity dataset lack screen information. Rather than introduce more uncertainty by trying to correct for an uncertain value, no additional mathematical corrections were added to account for partially penetrating wells. There was also no attempt to filter the well dataset using a ratio of screen length to aquifer thickness, again due to the lack of screen information.

Because of the many assumptions and simplifications involved in calculating transmissivity from specific capacity, the calculated transmissivity values are considered more uncertain than values determined from aquifer pumping tests. However, the available data from aquifer pumping tests are insufficient to develop a distribution of transmissivity across most of the study area. Therefore, using the specific capacity data greatly improves coverage and is useful for providing a general idea of relative transmissivity values in the aquifer.

For the purposes of this analysis, the few wells with calculated transmissivity values of greater than 15,000 square feet per day and/or with reported yields greater than 500 gallons per minute were not considered representative of Trinity hydrostratigraphic units. In the Upper Trinity hydrostratigraphic units, transmissivities with greater than 1,000 square feet per day were also discarded, as they appear anomalous when compared to other nearby Upper Trinity hydrostratigraphic units wells. These anomalies could potentially be due to partial screens in other units, particularly the Edwards hydrostratigraphic unit, and so are considered unreliable.

4.5.5 Spatial Distribution of Transmissivity and Horizontal Hydraulic Conductivity

The transmissivity values calculated from specific capacity data using the Mace (2001) empirical relationship and the aquifer pumping test transmissivity values compiled from the literature are shown in Figure 4.5.7, Figure 4.5.8, and Figure 4.5.9 for the Upper Trinity, Middle Trinity, and Lower Trinity hydrostratigraphic units, respectively. In the figures, the transmissivity values calculated for wells with a reported well radius are plotted separately from the values calculated for wells with an assumed well radius. As shown, the transmissivity values calculated for all Trinity hydrostratigraphic units from specific capacity using Equation 4.5.1 are consistent with the Mace (2001) empirical relationship developed for the Hensell and Hosston formations. For this reason, the transmissivity values used in the current analysis were calculated directly from this relationship, rather than from the Theis analysis. This simplifies the calculation and eliminates the need to assume values for well radius and storativity.

Conceptual Model Report for the Hill Country Trinity Aquifer
Groundwater Availability Model

In general, the highest transmissivities in the Upper Trinity hydrostratigraphic unit occur in the western portion of the study area in Edwards, Real and Val Verde counties. The highest transmissivities in the Middle Trinity hydrostratigraphic unit occur in the central portion of the study area, generally clustered around outcrop areas in Hays, Comal, Kendall, Bandera, and Gillespie counties. The highest transmissivities in the Lower Trinity hydrostratigraphic unit occur in Kerr and Bandera counties and along the Comal/Hays county boundary. High values also occur in central Comal and northern Medina counties, but as these are surrounded by values of much lower transmissivity, these may be anomalies and not be representative of actual conditions.

In a confined aquifer, hydraulic conductivity can be calculated as the transmissivity divided by the aquifer thickness. Using the aquifer thickness based on the structural surfaces developed for this project and the transmissivity values shown in Figure 4.5.7, Figure 4.5.8, and Figure 4.5.9 estimated hydraulic conductivities for the aquifer were generated. Note that this calculation assumes that wells are screened over the entire aquifer thickness. The resultant distribution of estimated horizontal hydraulic conductivity for the Upper Trinity, Middle Trinity, and Lower Trinity are shown in Figure 4.5.10, Figure 4.5.11, and Figure 4.5.12, respectively. In general, the spatial distribution of hydraulic conductivity is consistent with the spatial distribution of transmissivity discussed earlier. Note that neither the transmissivity nor hydraulic conductivity values were interpolated. This was to prevent emphasizing potentially misleading anomalies caused by high variability in densely spaced point values. Values derived from the range and statistical distribution of the point values are more likely to be representative of actual regional aquifer properties.

Representative values for transmissivity derived from the point values are presented in Table 4.5.2 and compared to literature values in Table 4.5.3 and Figure 4.5.13. Representative values for hydraulic conductivity derived from the point values are presented as histograms in Figure 4.5.14, and compared to literature values in Figure 4.5.15. Only one long-term aquifer pumping test is available in the Upper Trinity hydrostratigraphic unit. It has a transmissivity value of 199 square feet per day. The median transmissivity value for the Upper Trinity hydrostratigraphic unit is 28 square feet per day when calculated from a combination of the long-term aquifer pumping test and specific capacity tests. This is comparable to literature values in Ashworth (1983) and Hunt and others (2010) (Table 4.5.4). A histogram of the horizontal hydraulic conductivity estimates for the Upper Trinity hydrostratigraphic unit is shown in Figure 4.5.14a. The median hydraulic conductivity value for the Upper Trinity hydrostratigraphic unit is 0.4 feet per day when calculated from long-term aquifer pumping tests only and 0.07 feet per day when calculated from a combination of long-term aquifer pumping tests and specific capacity tests. These values are comparable to values in Young and others (2005) and Hunt and others (2010) but much lower than the calibrated value from Jones and others (2011).

The median transmissivity value for the Middle Trinity hydrostratigraphic unit is 159 square feet per day when calculated from long-term aquifer pumping tests only and 73 square feet per day when calculated from a combination of long-term aquifer pumping tests and specific capacity tests. The value calculated from only the aquifer pumping tests matches literature values from Ashworth (1983) and Hunt and others (2010) more closely than the value that includes specific capacity tests (Table 4.5.3). A histogram of the horizontal hydraulic conductivity estimates for the Middle Trinity hydrostratigraphic unit is shown in Figure 4.5.14b. The median hydraulic conductivity for the Middle Trinity hydrostratigraphic unit is 0.5 feet per day when calculated

from long-term aquifer pumping tests only and 0.2 feet per day when calculated from a combination of long-term aquifer pumping tests and specific capacity tests. Both values are an order of magnitude lower than the literature values from Young and others (2005), Hunt and others (2010), and Jones and others (2011) but similar to the calibrated value for the lower member of the Glen Rose Formation in Oliver and Pinkard (2018)(Table 4.5.5).

The median transmissivity value for the Lower Trinity hydrostratigraphic unit is 214 square feet per day when calculated from long-term aquifer pumping tests only and 63 square feet per day when calculated from a combination of long-term aquifer pumping tests and specific capacity tests. The value calculated from only the aquifer pumping tests matches the literature value from Hunt and others (2010) more closely than the value that includes specific capacity tests, but is still an order of magnitude lower than the value in Ashworth (1983)(Table 4.5.3). A histogram of the horizontal hydraulic conductivity estimates for the Lower Trinity hydrostratigraphic unit is shown in Figure 4.5.14c. The median hydraulic conductivity for the Lower Trinity hydrostratigraphic unit is 0.5 feet per day when calculated from long-term aquifer pumping tests only and 0.2 feet per day when calculated from a combination of long-term aquifer pumping tests and specific capacity tests. Both values are an order of magnitude lower than the literature values from Hunt and others (2010) and Jones and others (2011) but are within the range of values in LBG-Guyton (2005)(Table 4.5.5).

4.5.6 Vertical Hydraulic Conductivity

At very small scales, the vertical and horizontal hydraulic conductivity of an aquifer may differ by very little. However, on a regional scale, the differences between the vertical and horizontal hydraulic conductivities can be very large. In areas where the aquifer is thought to be largely structurally intact, the vertical hydraulic conductivity is limited by the hydraulic conductivity of lower permeability units. For instance, a continuous low permeability clay layer in the middle of a sandy aquifer could greatly impede vertical flow in what would otherwise be a high permeability system. This could create a difference of several orders of magnitude between vertical and horizontal hydraulic conductivity.

Within the Trinity Aquifer as a whole, this vertical anisotropy is evident in observed groundwater behavior. As discussed in Barker and Ardis (1996), the tight low-permeability interbeds in the upper and middle parts of the Trinity Aquifer severely restrict vertical flow so that groundwater moves laterally along impermeable bedding (often discharging from seeps and springs) rather than percolating into lower portions of the aquifer. One study in North Bexar County estimated that the vertical hydraulic conductivity of these confining units of the Trinity Aquifer, including the Hammett Shale, Bexar Shale, and the clays and marls of upper member of the Glen Rose Limestone, was only around 0.0001 to 0.003 feet per day (W.E. Simpson Company and William F. Guyton Associates, 1993). This effectively separates the permeable units of Trinity Aquifer into distinct hydrostratigraphic units with low inter-formational leakage. Anaya and Jones (2009) also considered the effect of this stratification on groundwater flow in the HCT Aquifer region compared to other portions of the Edwards-Trinity (Plateau) Aquifer. They note that the shale, sand, and limestone transgressive-regressive sequence represented by the Upper, Middle and Lower Trinity sediments introduces significant vertical anisotropy compared to the thinner, but more homogenous Trinity Sands in the northwest portion of the Edwards-Trinity (Plateau) Aquifer (Anaya and Jones, 2009).

Conceptual Model Report for the Hill Country Trinity Aquifer Groundwater Availability Model

Because vertical groundwater flow in the Trinity Aquifer and Edwards-Trinity (Plateau) Aquifer is dominated by the presence of underlying or overlying low-permeability units, there is little discussion in the literature about vertical anisotropy within individual hydrostratigraphic units themselves. The exception is the Upper Trinity hydrostratigraphic unit which contains the low-permeability clays and marls of upper member of the Glen Rose Limestone discussed in the North Bexar County report mentioned above (W.E. Simpson Company and William F. Guyton Associates, 1993). Kuniansky and Ardis (2004) noted that water in flat-lying sedimentary aquifers, such as “the cyclic depositional environments of the Edwards–Trinity aquifer,” generally flows more readily horizontally than vertically and cited observed horizontal plant growth along hillsides as evidence. Jones and others (2011) make a similar assumption that “vertical hydraulic conductivities are likely to be much lower than horizontal hydraulic conductivities” and assumes starting anisotropy ratios of 1:10 (that is, vertical hydraulic conductivity values are one-tenth the value of horizontal hydraulic conductivity values). Oliver and Pinkard (2018) estimated vertical hydraulic conductivity values by calibrating an analytic element model to match aquifer test data in Hays County. In this model, the calibrated vertical hydraulic conductivity value was 1×10^{-5} feet per day for the upper member of the Glen Rose Formation, 0.1 feet per day for the lower member of the Glen Rose Formation, 1×10^{-5} feet per day for the Hensell Formation, 0.4 feet per day for the Cow Creek Limestone, and 1×10^{-9} feet per day for the Hammett Shale.

4.5.7 Storage Properties

The most representative storage properties are determined through analysis of observation well data from aquifer pumping tests. The compilation of transmissivity measurements (Section 4.5.1) yielded several pumping test records that also contained calculated storativity values. The distribution of available storativity data is shown in Table 4.5.6. Representative values from these tests are shown in 6. The median storativity value from the compiled point measurements is 2×10^{-4} for the Middle Trinity hydrostratigraphic unit and 8×10^{-5} for the Lower Trinity hydrostratigraphic unit. There were no values available for the Upper Trinity hydrostratigraphic unit. These calculated values are very sparse, as many aquifer test reports include estimated values or literature values rather than calculated values from pumping test data (Hunt and others, 2010). For this reason, additional literature sources and calibrated groundwater models were also queried for estimates of storage properties.

Literature Sources for Unconfined Specific Yield Values

The GAM for the Edwards-Trinity Plateau Aquifer (Anaya and Jones, 2009) included a Trinity model layer that could be considered equivalent to a combination of the Upper, Middle, and Lower Trinity hydrostratigraphic units discussed in the current report. Calibrated specific yield values in that model were 0.03 for the area roughly corresponding to the HCT Aquifer outcrop. For the rest of the study area, calibrated specific yield ranged from 0.0003 to 0.003. A re-calibration of this GAM (Young and others, 2010) produced calibrated specific yield values in the Trinity Aquifer that ranged from 0.05 to 0.1, with a median value of 0.08. The GAM for the HCT Aquifer (Jones and others, 2011) produced calibrated specific yield values of 0.0005 for the Upper Trinity Aquifer, 0.0008 for the Middle Trinity Aquifer, and 0.0008 for the Lower Trinity Aquifer.

Literature Sources for Confined Storativity Values

Conceptual Model Report for the Hill Country Trinity Aquifer
Groundwater Availability Model

Walker (1979) compiled hydraulic parameters from aquifer tests in the “Lower Cretaceous Aquifer” in the Edwards-Trinity (Plateau) region. The compilation includes a Hensell (Middle Trinity hydrostratigraphic unit) aquifer test in Gillespie County with a storage coefficient of 7×10^{-5} and five Hosston and Sligo (Lower Trinity hydrostratigraphic unit) aquifer tests in Kerrville with storage coefficients ranging from 2×10^{-5} to 5×10^{-5} . These are presumably the same aquifer tests discussed in Ashworth (1983) which provides six storage coefficients from aquifer tests in the HCT Aquifer. The storage coefficients from four wells completed in Sligo and Hosston sediments (Lower Trinity hydrostratigraphic unit) ranged from 2×10^{-5} to 5×10^{-5} . The storage coefficient for one well completed in the Hensell Sand (Middle Trinity hydrostratigraphic unit) was 7×10^{-5} and the storage coefficient for another well completed in Cow Creek, Sligo and Hosston sediments (combination of Middle and Lower Trinity hydrostratigraphic units) was 7.4×10^{-4} .

The pumping test database associated with the GAM for the Edwards-Trinity Plateau Aquifer (Anaya and Jones, 2009) contained several pump test records with calculated storativity values. Eight of these wells were classified as Trinity wells and have a median storage coefficient of 3×10^{-4} , however, none of these wells fell in the current study area.

The Barton Springs Edwards Aquifer Conservation District compiled pumping tests conducted in Hays and Trinity counties (Hunt and others, 2010). Storativity values calculated from pumping tests in the Upper Trinity Aquifer ranged from 1×10^{-5} to 1.3×10^{-5} with a median value of 1.2×10^{-5} . Storativity values calculated from pumping tests in the Middle Trinity Aquifer ranged from 1.85×10^{-6} to 3.4×10^{-2} with a median value of 5×10^{-5} . Storativity values calculated from pumping tests in the Lower Trinity Aquifer ranged from 4×10^{-6} to 5×10^{-3} with a median value of 5×10^{-5} .

When calculated field storativity values are scarce, calibrated groundwater models can also provide additional data. In a groundwater model of the Edwards-Trinity (Plateau), Edwards (Balcones Fault Zone) and Trinity aquifers (Kuniansky and Ardis, 2004), the storage coefficients for the Trinity Aquifer above the Hammett confining unit (Upper and Middle Trinity hydrostratigraphic units) range from 1×10^{-3} to 1×10^{-5} . The storage coefficient for the Trinity Aquifer below the Hammett confining unit (Lower Trinity hydrostratigraphic unit) was 1×10^{-5} . A groundwater model of the Lower Trinity Aquifer in Bandera County (LBG-Guyton Associates, 2008) produced a calibrated storativity range of 5×10^{-6} to 8×10^{-5} in the Lower Trinity hydrostratigraphic unit.

Several calibrated groundwater models also provide specific storage estimates. The GAM for the Edwards-Trinity Plateau (Plateau) Aquifer (Anaya and Jones, 2009) included a Trinity model layer that could be considered equivalent to a combination of the Upper, Middle, and Lower Trinity hydrostratigraphic units discussed in the current report. Calibrated specific storage values in that model ranged from 10^{-5} feet⁻¹ in an area roughly corresponding to the HCT Aquifer outcrop to 10^{-7} feet⁻¹ in an area roughly corresponding to the HCT Aquifer subcrop under the Edwards (Balcones Fault Zone) Aquifer. For the rest of the study area, calibrated specific storage in the Trinity Aquifer layer was 10^{-6} feet⁻¹. A re-calibration of that GAM (Young and others, 2010) produced calibrated specific storage values in the portion of the Trinity Aquifer roughly equivalent to the current study area that ranged from 2.9×10^{-6} to 9.7×10^{-6} feet⁻¹ with a median

Conceptual Model Report for the Hill Country Trinity Aquifer
Groundwater Availability Model

value of 9.2×10^{-6} feet⁻¹. The GAM for the HCT Aquifer (Jones and others, 2011) produced calibrated specific storage values of 1.0×10^{-6} feet⁻¹ for the Upper Trinity Aquifer, 1.0×10^{-7} feet⁻¹ for the Middle Trinity Aquifer, and 1.0×10^{-7} feet⁻¹ for the Lower Trinity Aquifer. Oliver and Pinkard (2018) estimated specific storage values by calibrating an analytic element model to match aquifer test data in Hays County. In this model, the calibrated specific storage value was 1.5×10^{-5} feet⁻¹ for the upper member of the Glen Rose Formation, 1×10^{-6} feet⁻¹ for the lower member of the Glen Rose hydrostratigraphic unit, 1×10^{-6} feet⁻¹ for the Hensell Formation, 8×10^{-7} feet⁻¹ for the Cow Creek Limestone, and 1×10^{-6} feet⁻¹ for the Hammett Shale.

Conceptual Model Report for the Hill Country Trinity Aquifer
Groundwater Availability Model

Table 4.5.1 Hydraulic property data available for each hydrostratigraphic unit

	Number of Data Values		
	Transmissivity	Hydraulic Conductivity	Specific Capacity
Upper Trinity	1	0	217
Middle Trinity	58	38	857
Lower Trinity	17	7	393
mixed Trinity	24	16	168
All Trinity	100	61	1,635

Table 4.5.2 Transmissivity values from compiled pump tests and calculated from specific capacity data

Hydrostratigraphic unit	Transmissivity values from Aquifer Pumping Tests (square feet per day)				Transmissivity values calculated from Specific Capacity (square feet per day)				All Transmissivity values from aquifer pumping tests and calculated from specific capacity (square feet per day)			
	25th		75th		25th		75th		25th		75th	
	Count	Percentile	Median	Percentile	Count	Percentile	Median	Percentile	Count	Percentile	Median	Percentile
Upper Trinity	1	--	199	--	217	7	28	70	218	8	28	70
Middle Trinity	58	41	159	521	857	28	73	206	915	28	79	212
Lower Trinity	17	142	214	317	393	35	56	135	410	35	63	148

Conceptual Model Report for the Hill Country Trinity Aquifer
Groundwater Availability Model

Table 4.5.3 Comparison of transmissivity values calculated in the current study and compiled from literature.

Hydrostratigraphic unit	Transmissivity (square feet per day)				
	Current Study			Literature Values	
	Aquifer Pumping Tests	Specific Capacity Tests	Combined	Ashworth (1983)	Hunt and others (2010)
	median	median	median	average value	median test value
Upper Trinity	199*	28	28	--	19
Middle Trinity	159	73	79	227	304
Lower Trinity	214	56	63	1,337	200

* based on 1 aquifer pumping test

Table 4.5.4 Hydraulic conductivity values from compiled pump tests and calculated from specific capacity data

Hydrostratigraphic unit	Hydraulic conductivity values calculated from Aquifer Pumping Tests (feet per day)				Hydraulic conductivity values calculated from Specific Capacity (feet per day)				All Hydraulic conductivity values calculated from aquifer pumping tests and specific capacity (feet per day)			
	25th		75th		25th		75th		25th		75th	
	Count	Percentile	Median	Percentile	Count	Percentile	Median	Percentile	Count	Percentile	Median	Percentile
Upper Trinity	1	--	0.4	--	217	0.02	0.07	0.2	218	0.02	0.07	0.2
Middle Trinity	58	0.1	0.5	1	857	0.06	0.2	0.6	915	0.06	0.2	0.6
Lower Trinity	17	0.3	0.5	1.5	393	0.1	0.2	0.4	410	0.1	0.2	0.4

Conceptual Model Report for the Hill Country Trinity Aquifer
Groundwater Availability Model

Table 4.5.5 Comparison of hydraulic conductivity values calculated in the current study and compiled from literature.

Hydrostratigraphic unit	Hydraulic Conductivity (feet per day)							
	Current Study			Literature Values				
	Aquifer Pumping Tests	Specific Capacity Tests	Combined	Young and others (2005)	LBG-Guyton (2008)	Hunt and others (2010)	Jones and others (2011)	Oliver and Pinkard (2018)
	median	median	median	calibrated value	calibrated value	median test value	calibrated average	calibrated value
Upper Trinity	0.4*	0.07	0.07	0.5	--	0.08 ⁺	10.4	0.001
Middle Trinity	0.5	0.2	0.2	1.6 [#]	--	5	8.8	0.25 (lower Glen Rose) 4 (Cow Creek)
Lower Trinity	0.5	0.2	0.2	--	0.1 - 15	1.3	4.4	--

* based on 1 aquifer pumping test

+ average of 2 field test values

calibrated average value over the entire unit

Table 4.5.6 Storativity values available from compiled aquifer pump tests and compiled from literature.

Hydrostratigraphic unit	Count	Storativity						
		Current Study			Literature Values			
		Compiled aquifer pump tests			Ashworth (1983)	Kuniansky and Ardis (2004)	LBG-Guyton (2008)	Hunt and others (2010)
		Min	Median	Max	average test value	calibrated value	calibrated value	median test value
Upper Trinity	0	--	--	--	--	--	--	1.2x10 ⁻⁵
Middle Trinity	28	1x10 ⁻⁵	1x10 ⁻⁴	1.5x10 ⁻¹	7x10 ⁻⁵	--	--	5x10 ⁻⁵
Lower Trinity	6	1x10 ⁻⁵	8x10 ⁻⁵	4.5x10 ⁻³	3.8x10 ⁻⁵	1x10 ⁻⁵	5x10 ⁻⁶ - 8x10 ⁻⁵	5x10 ⁻⁵
mixed Trinity	13	1x10 ⁻⁵	9x10 ⁻⁵	4x10 ⁻⁴	--	--	--	--
All Trinity	47	1x10 ⁻⁵	2x10 ⁻⁴	1.5x10 ⁻¹	--	--	--	--

Conceptual Model Report for the Hill Country Trinity Aquifer
Groundwater Availability Model

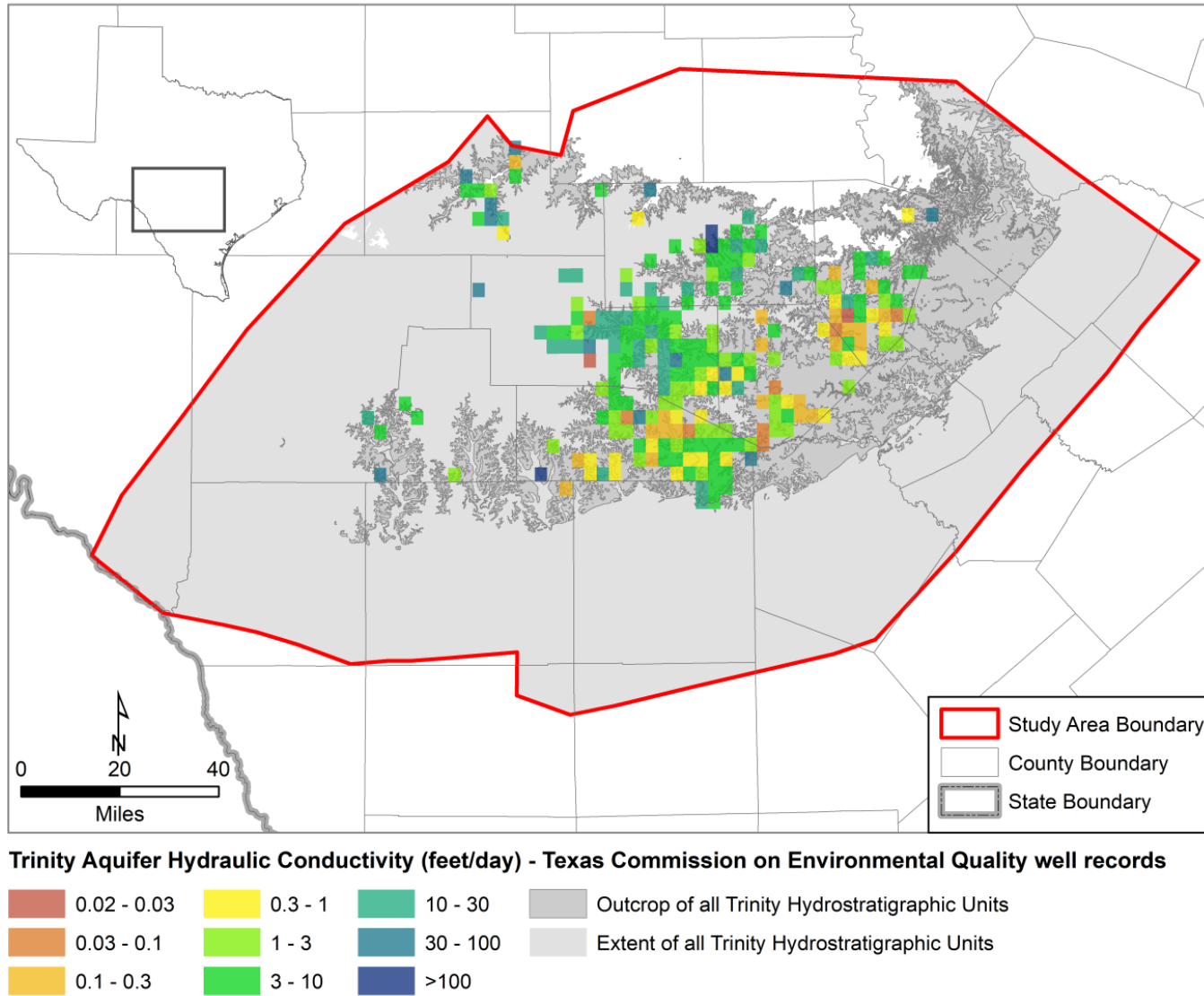
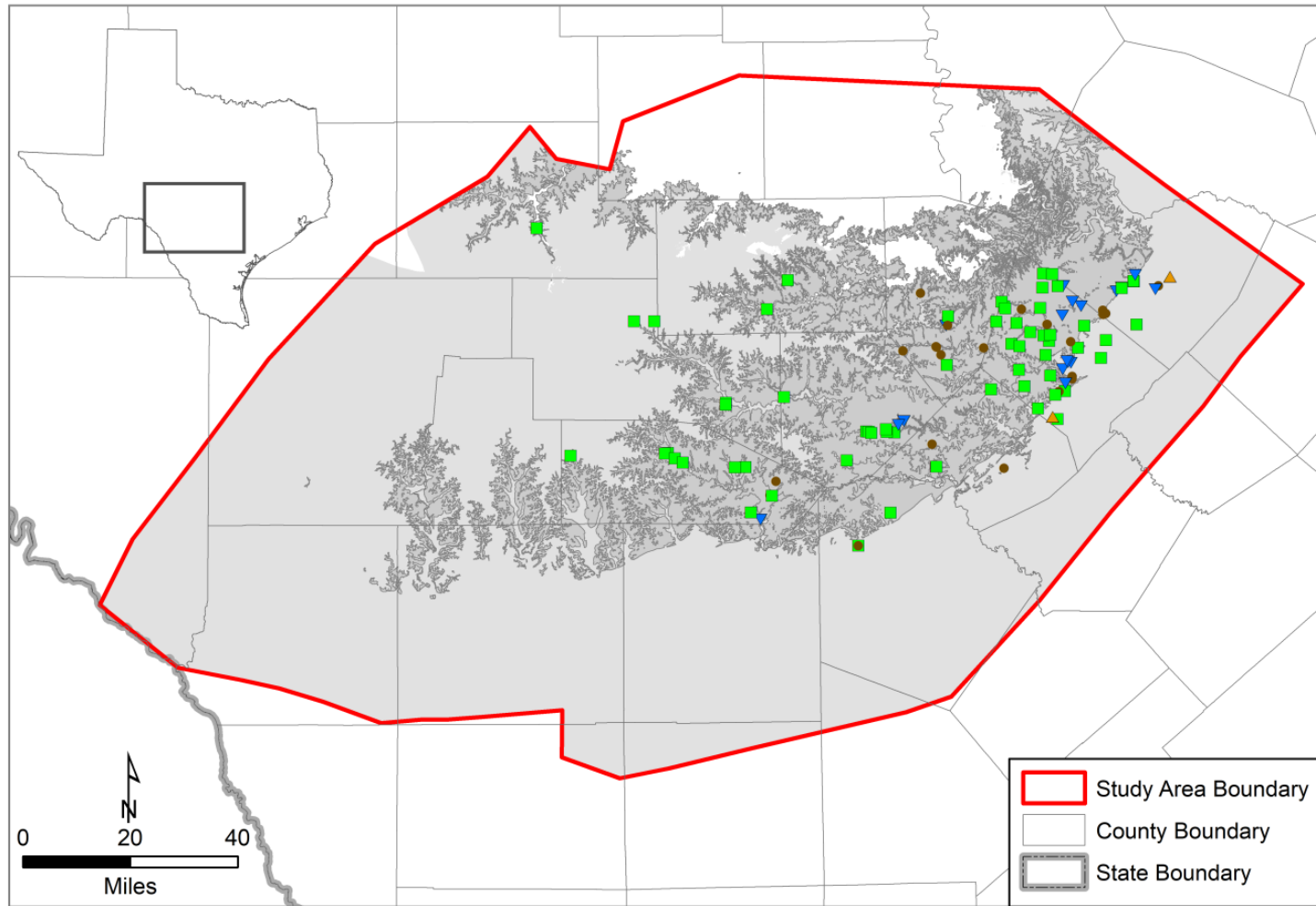

Figure 4.5.1 Distribution of horizontal hydraulic conductivity calculated from Texas Commission on Environmental Quality well records, based on the Edwards-Trinity (Plateau) Aquifer GAM database (Anaya and Jones, 2009).

Conceptual Model Report for the Hill Country Trinity Aquifer
Groundwater Availability Model



Location of available Transmissivity data (by hydrostratigraphic unit)

- | | | |
|------------------|-----------------|---|
| ▲ Upper Trinity | ▼ Lower Trinity | ■ Outcrop of all Trinity hydrostratigraphic units |
| ■ Middle Trinity | ● mixed Trinity | ■ Extent of all Trinity hydrostratigraphic units |

Figure 4.5.2 Location of available transmissivity data by hydrostratigraphic unit in the study area.

Conceptual Model Report for the Hill Country Trinity Aquifer
Groundwater Availability Model

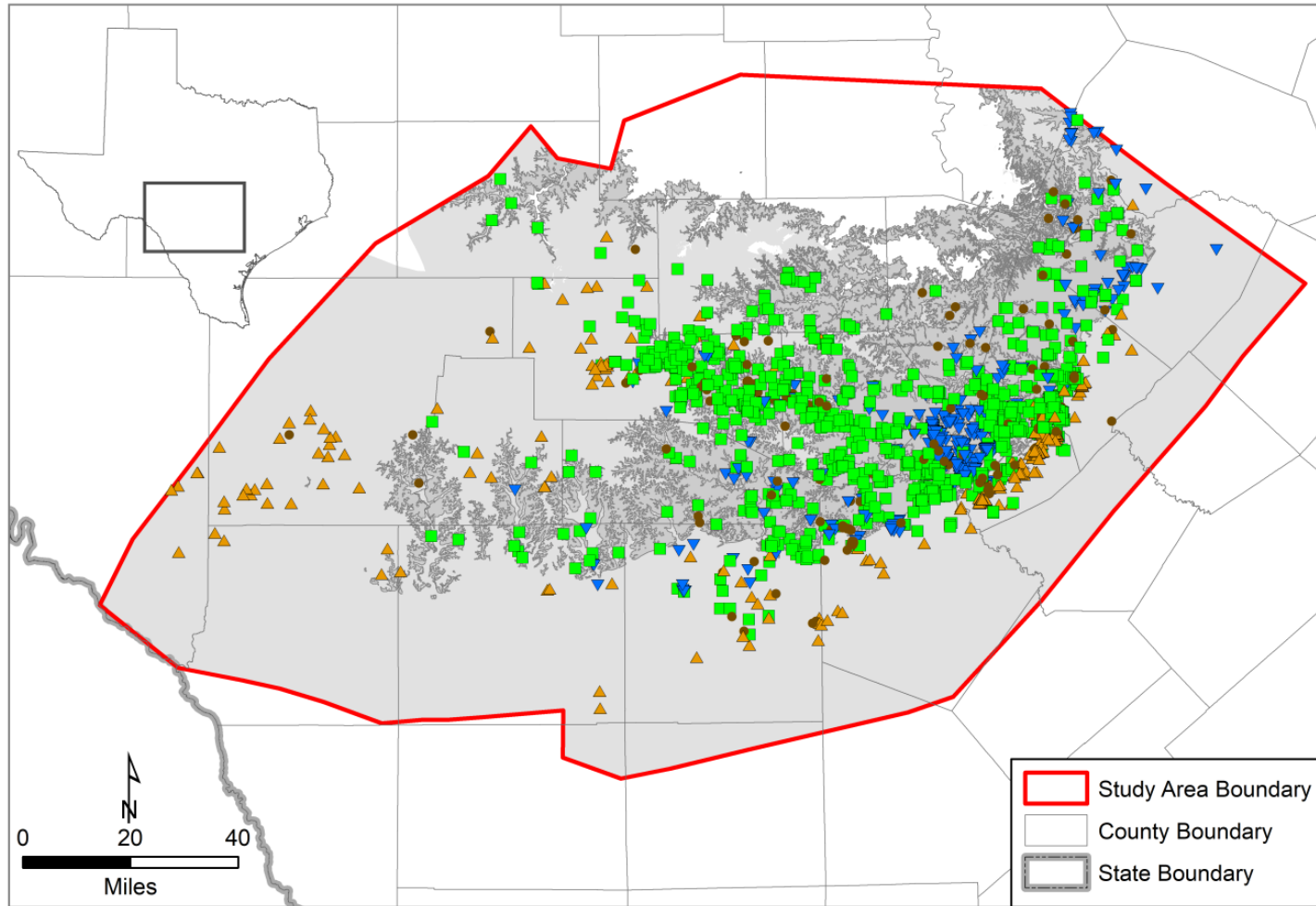

Location of available Specific Capacity data (by hydrostratigraphic unit)

- | | | |
|------------------|-----------------|---|
| ▲ Upper Trinity | ▼ Lower Trinity | ■ Outcrop of all Trinity hydrostratigraphic units |
| ■ Middle Trinity | ● mixed Trinity | ■ Extent of all Trinity hydrostratigraphic units |

Figure 4.5.3 Location of available specific capacity data by hydrostratigraphic unit in the study area.

Conceptual Model Report for the Hill Country Trinity Aquifer
Groundwater Availability Model

Estimated Upper Trinity Transmissivity

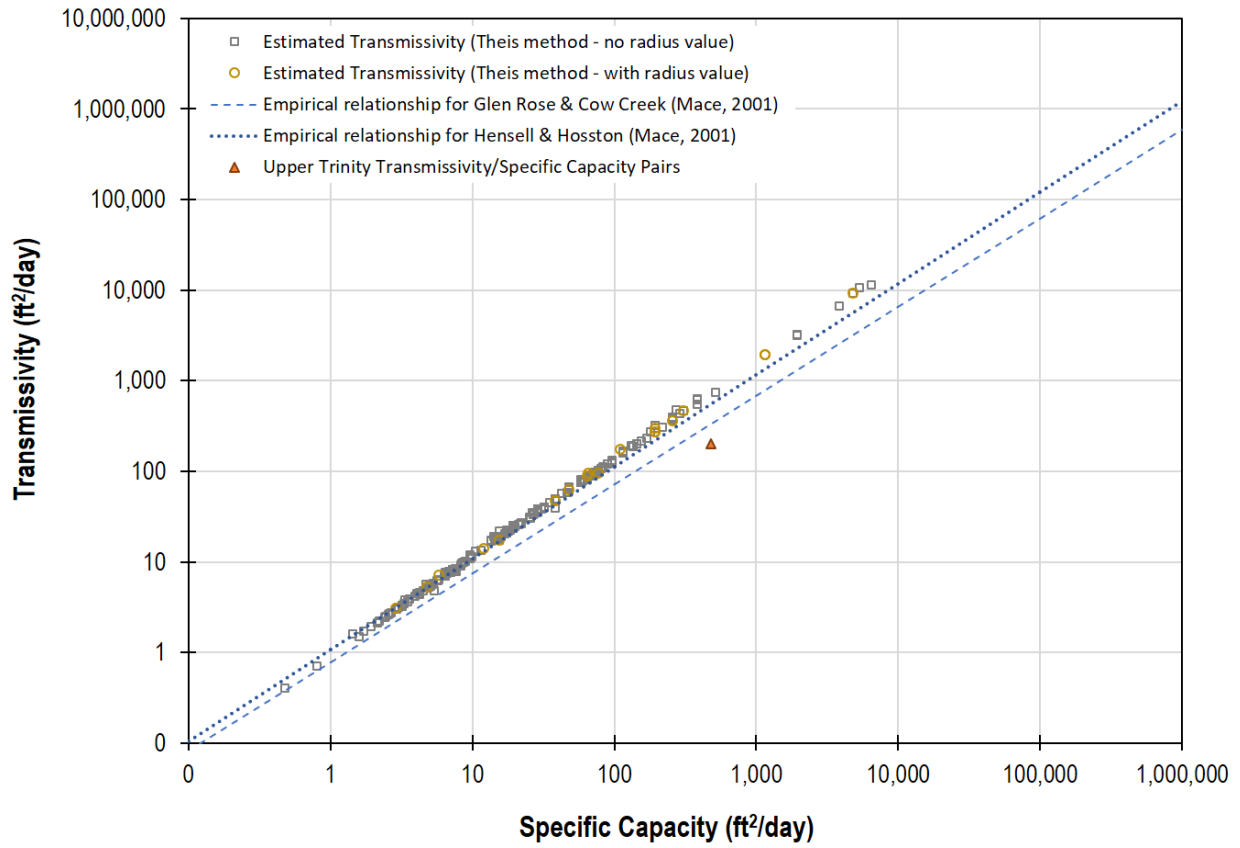

Figure 4.5.4 Upper Trinity transmissivity – specific capacity measurement pairs compared to transmissivity values calculated by Mace (2001) methods (empirical relationship and Theis method).

Conceptual Model Report for the Hill Country Trinity Aquifer
Groundwater Availability Model

Estimated Middle Trinity Transmissivity

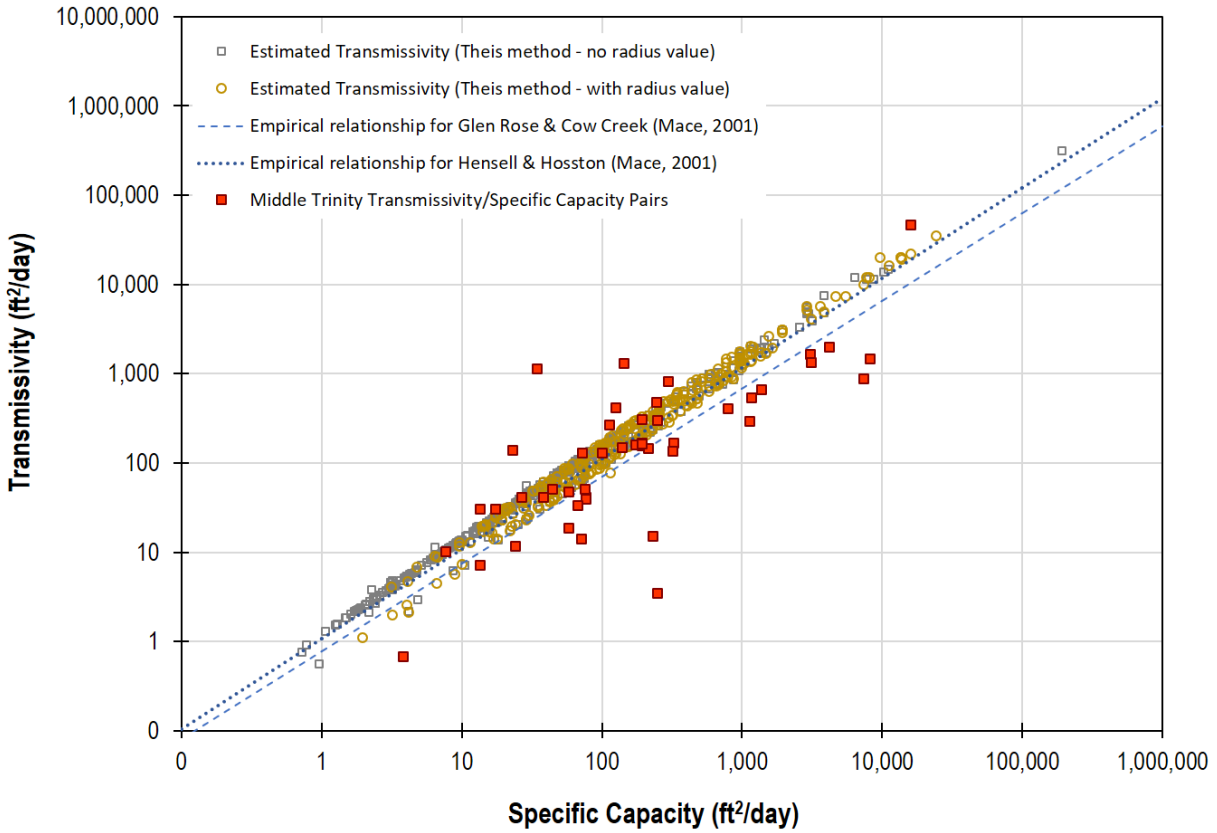

Figure 4.5.5 Middle Trinity transmissivity – specific capacity measurement pairs compared to transmissivity values calculated by Mace (2001) methods (empirical relationship and Theis method).

Conceptual Model Report for the Hill Country Trinity Aquifer
Groundwater Availability Model

Estimated Lower Trinity Transmissivity

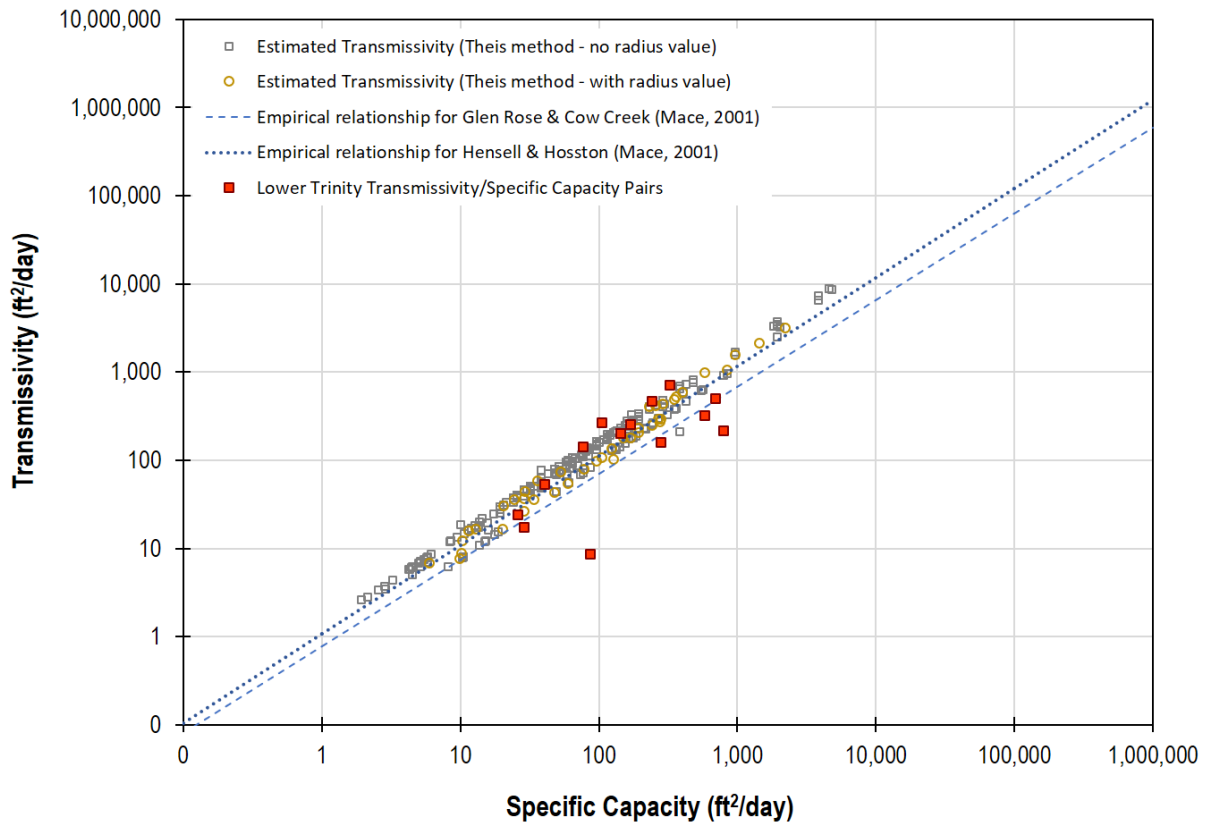

Figure 4.5.6 Lower Trinity transmissivity – specific capacity measurement pairs compared to transmissivity values calculated by Mace (2001) methods (empirical relationship and This method)

Conceptual Model Report for the Hill Country Trinity Aquifer
Groundwater Availability Model

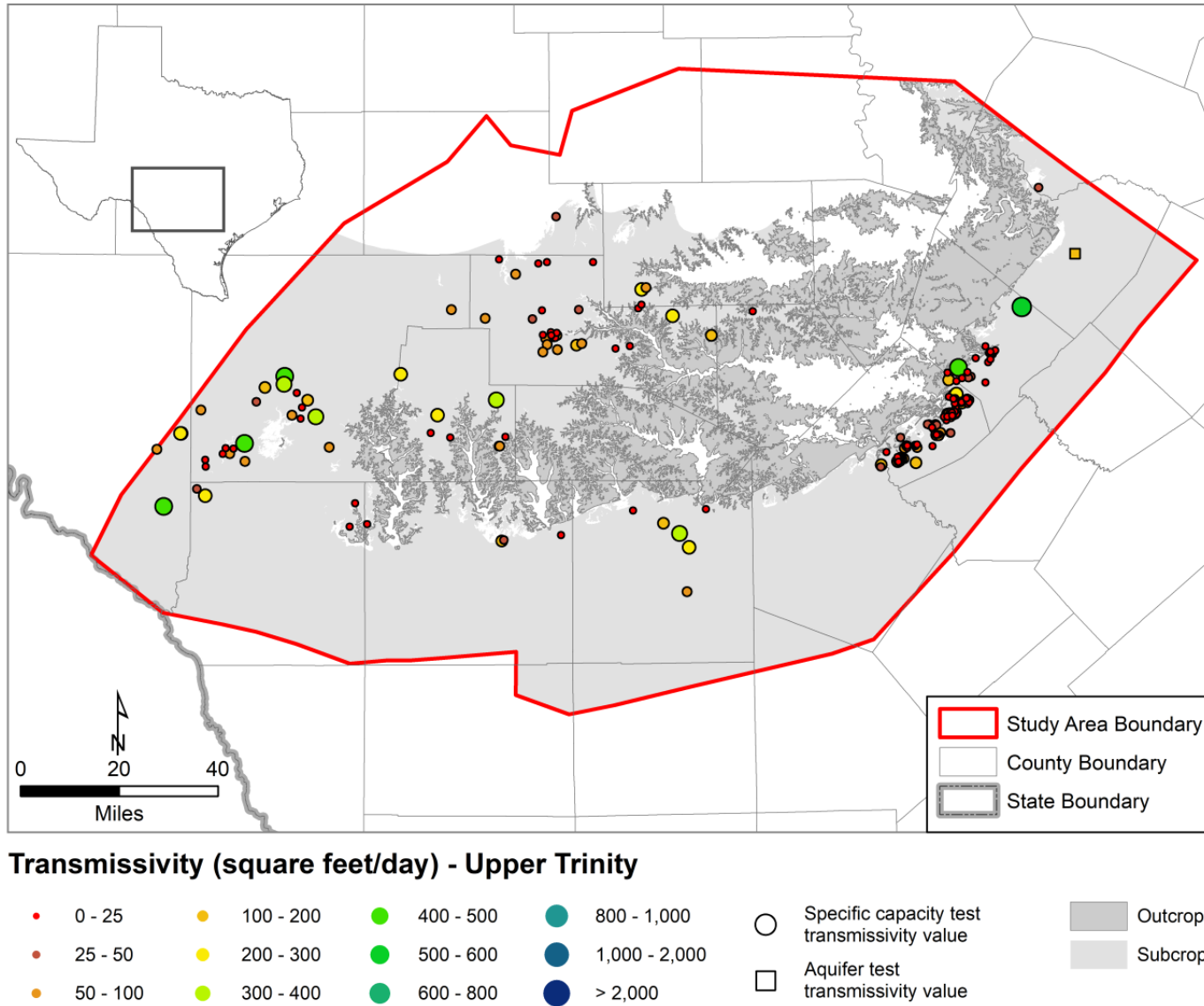

Figure 4.5.7 Spatial distribution of transmissivity values for the upper Trinity hydrostratigraphic unit.

Conceptual Model Report for the Hill Country Trinity Aquifer
Groundwater Availability Model

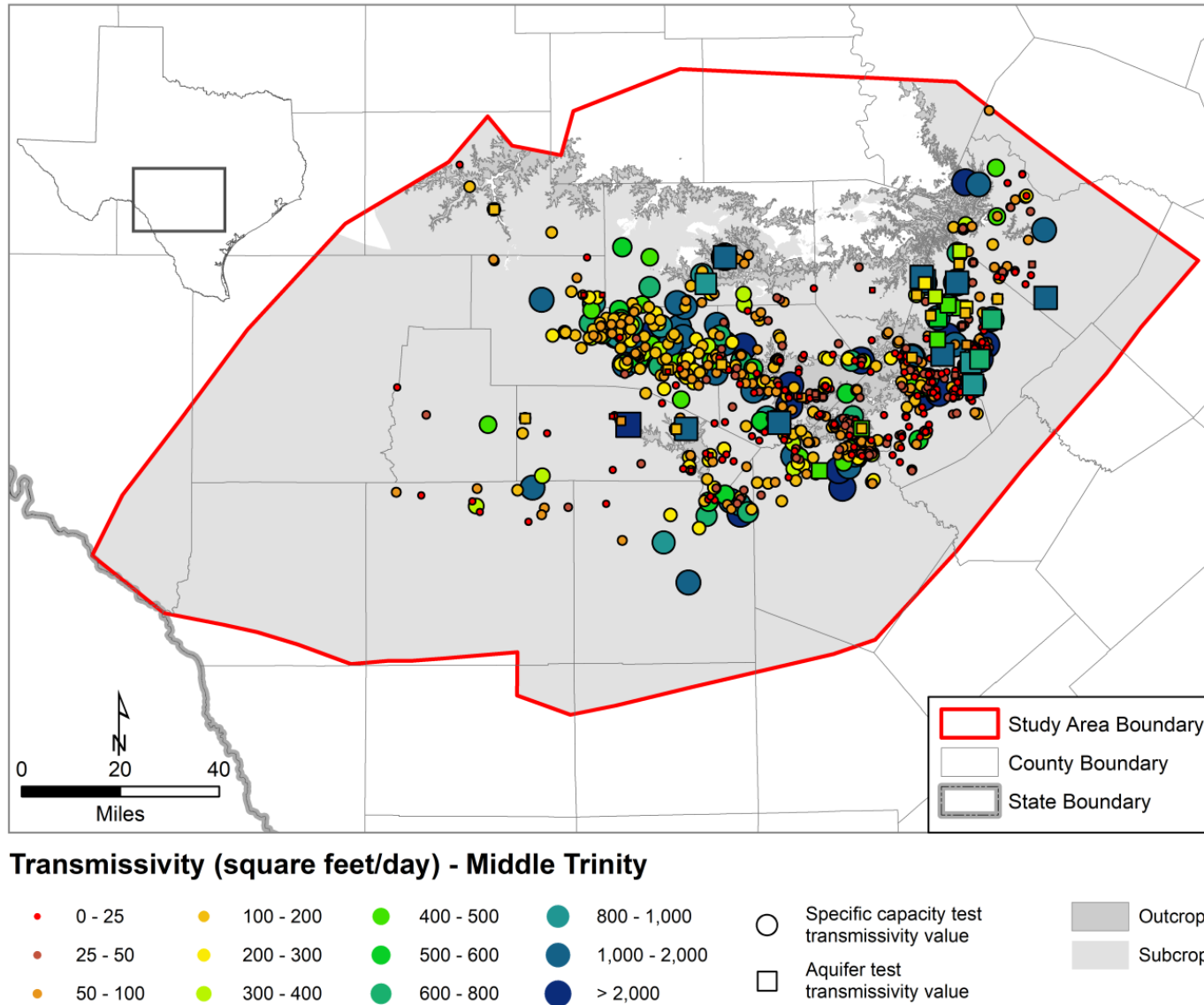

Figure 4.5.8 Spatial distribution of transmissivity values for the Middle Trinity hydrostratigraphic unit.

Conceptual Model Report for the Hill Country Trinity Aquifer
Groundwater Availability Model

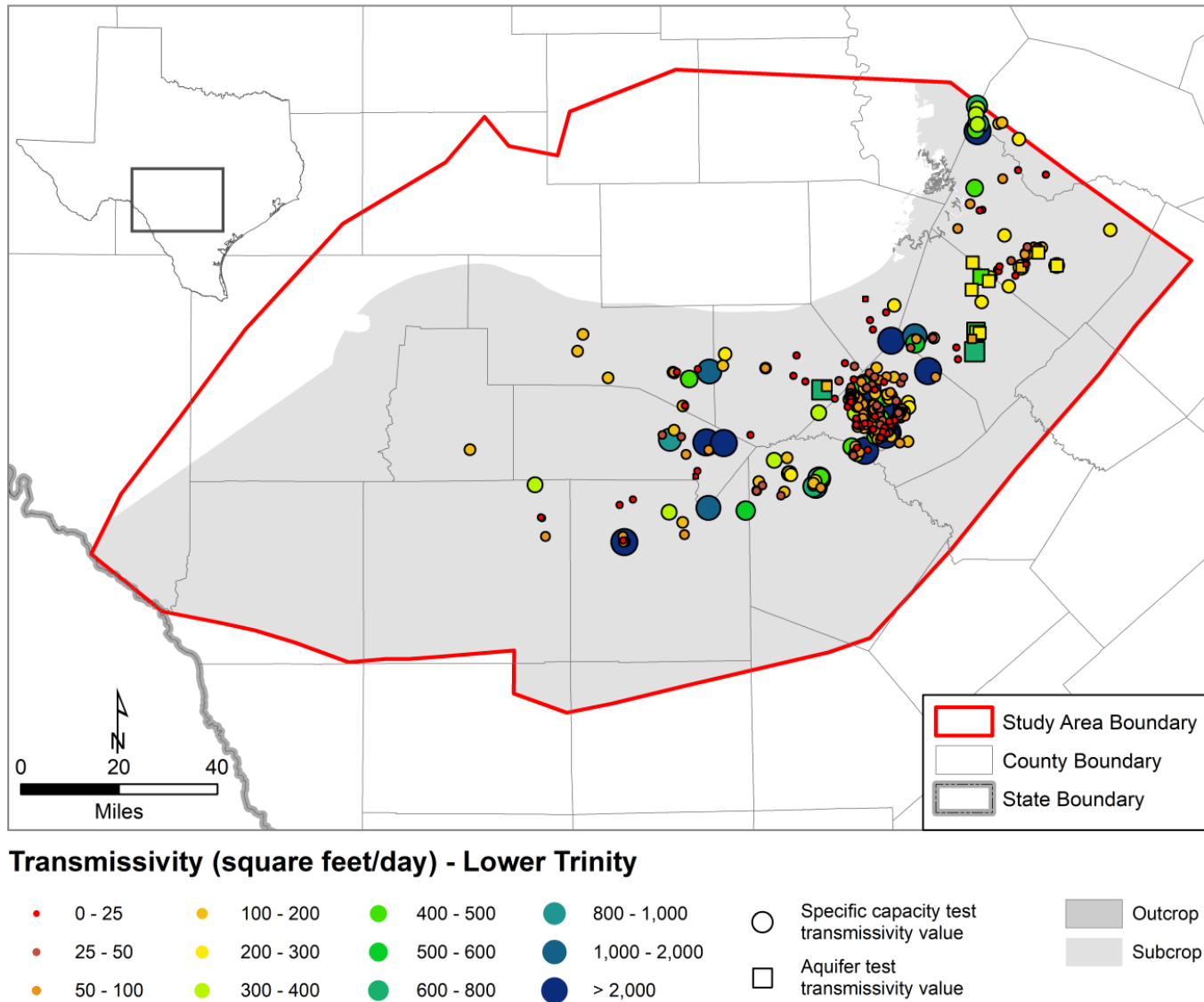

Figure 4.5.9 Spatial distribution of transmissivity values for the Lower Trinity hydrostratigraphic unit.

Conceptual Model Report for the Hill Country Trinity Aquifer
Groundwater Availability Model

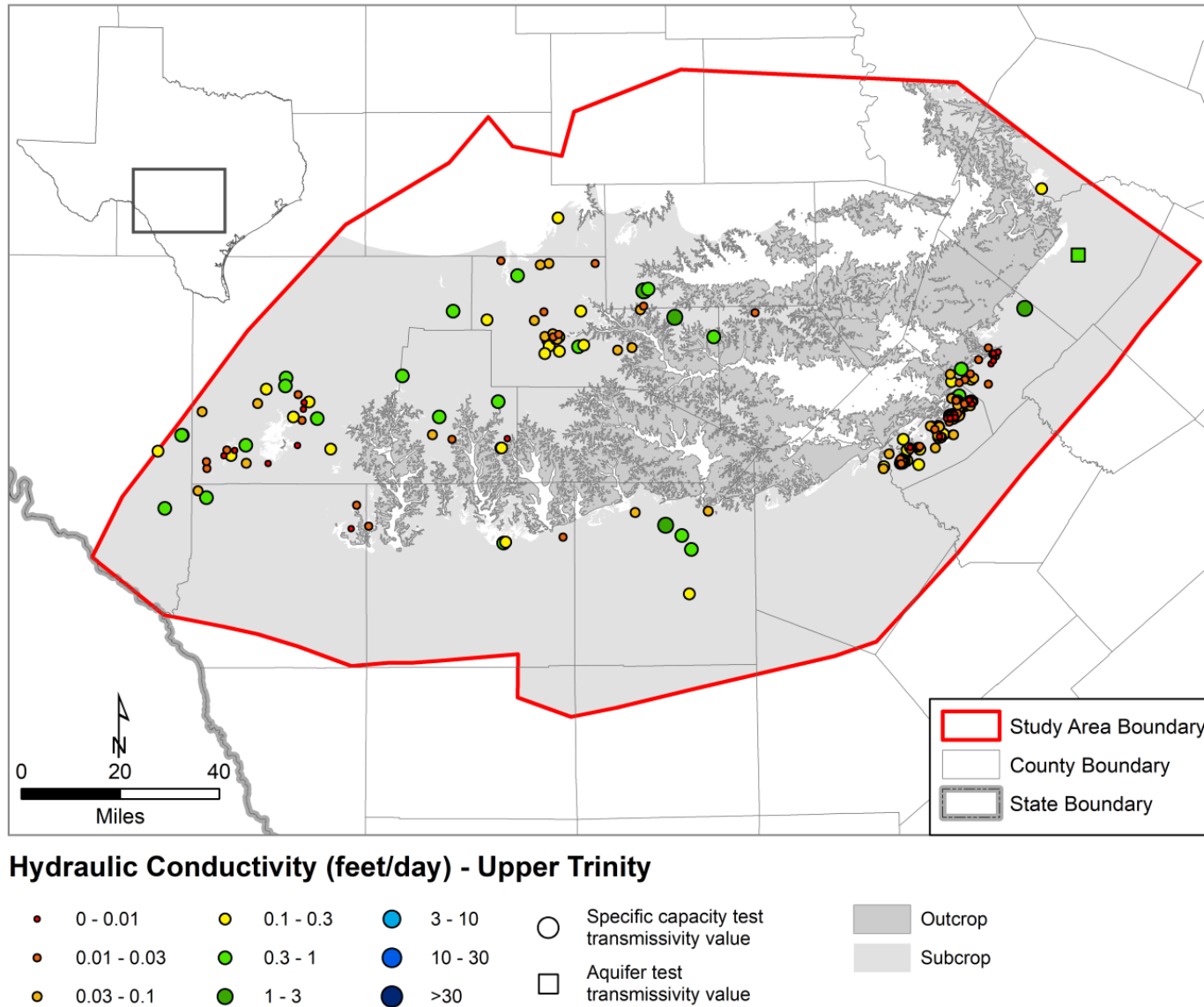
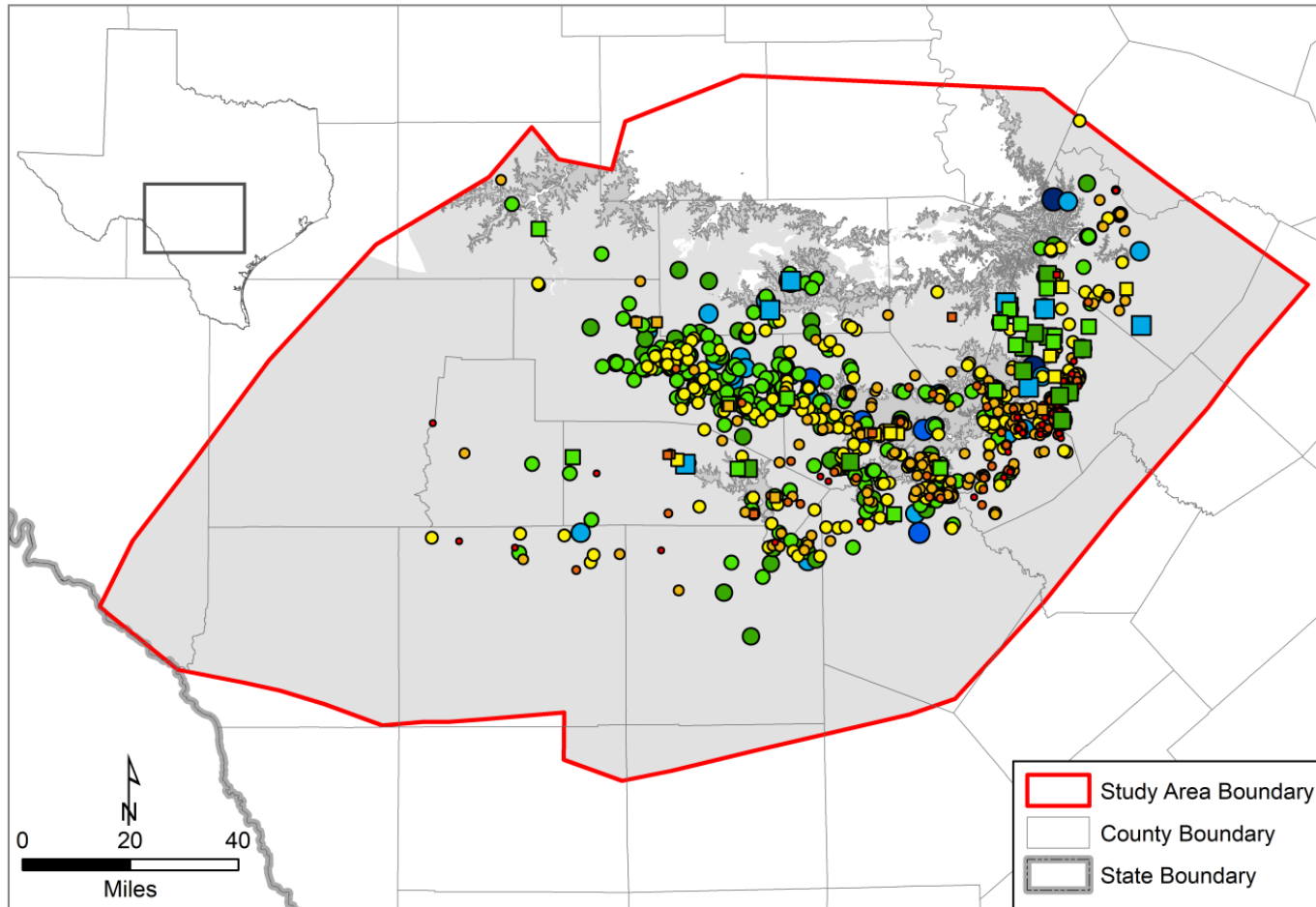

Figure 4.5.10 Spatial distribution of horizontal hydraulic conductivity values for the Upper Trinity hydrostratigraphic unit.

Conceptual Model Report for the Hill Country Trinity Aquifer
Groundwater Availability Model



Hydraulic Conductivity (feet/day) - Middle Trinity

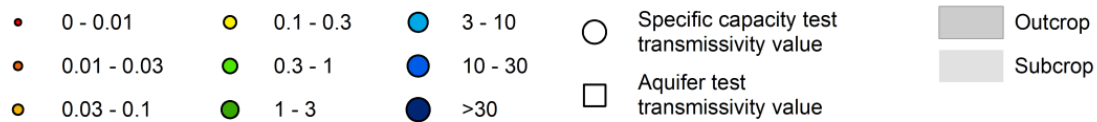

Figure 4.5.11 Spatial distribution of horizontal hydraulic conductivity values for the Middle Trinity hydrostratigraphic unit.

Conceptual Model Report for the Hill Country Trinity Aquifer
Groundwater Availability Model

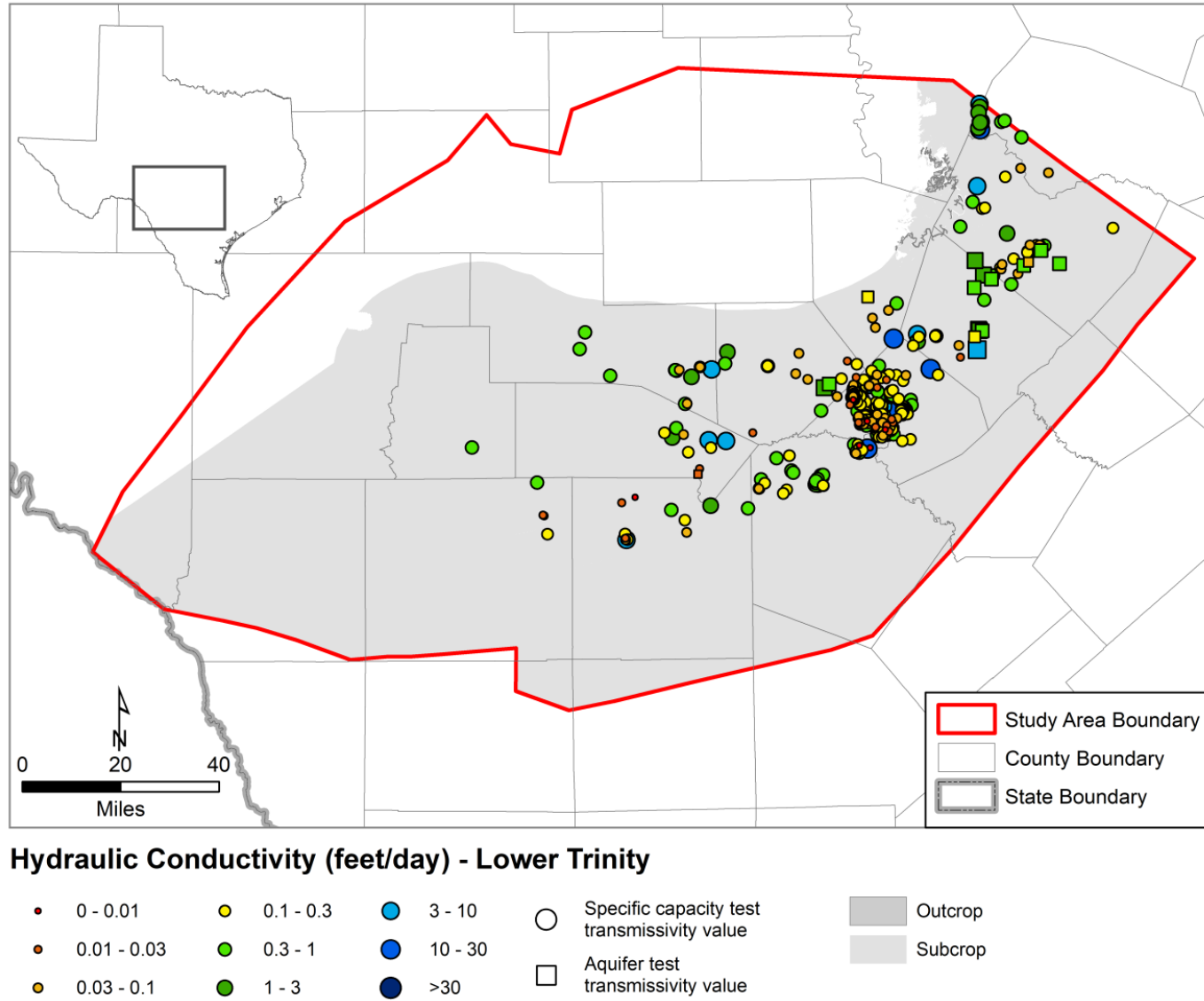

Figure 4.5.12 Spatial distribution of horizontal hydraulic conductivity values for the Lower Trinity hydrostratigraphic unit.

Conceptual Model Report for the Hill Country Trinity Aquifer
Groundwater Availability Model

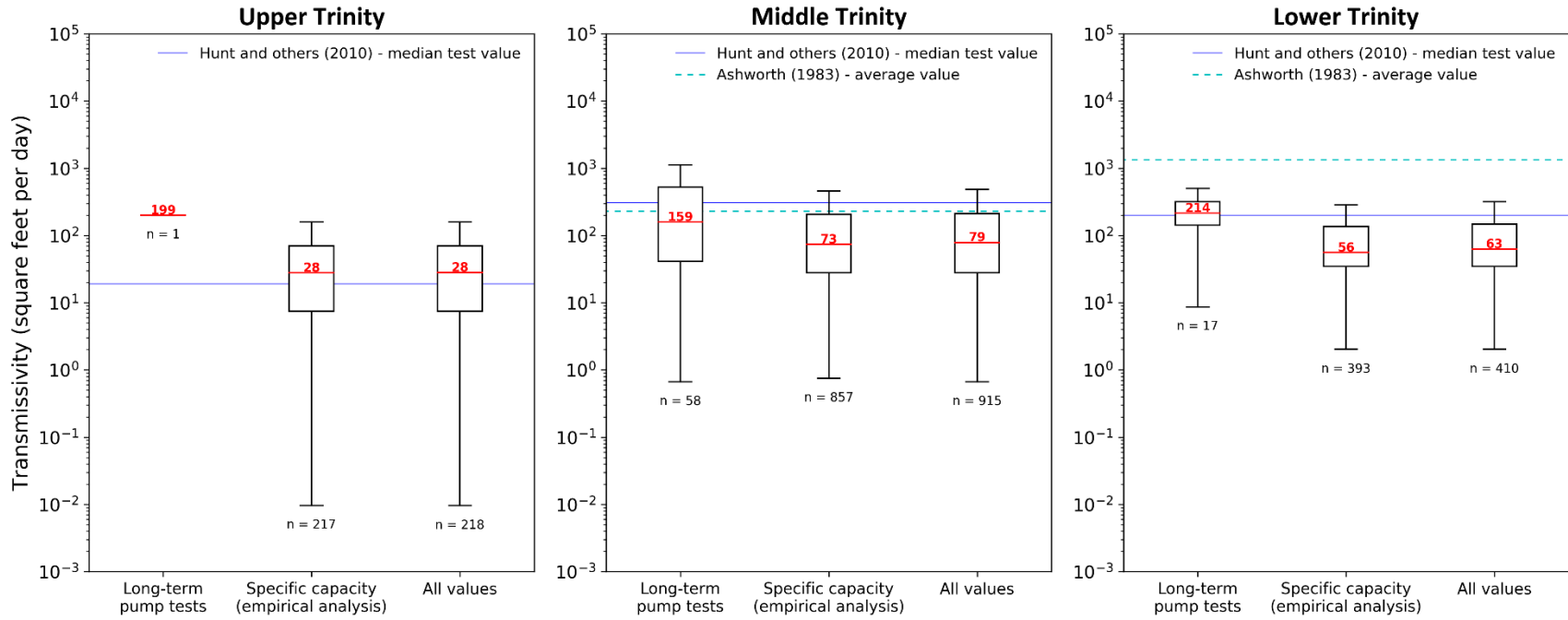

Figure 4.5.13 Comparison of calculated values and selected literature values for transmissivity by hydrostratigraphic unit.

Conceptual Model Report for the Hill Country Trinity Aquifer
Groundwater Availability Model

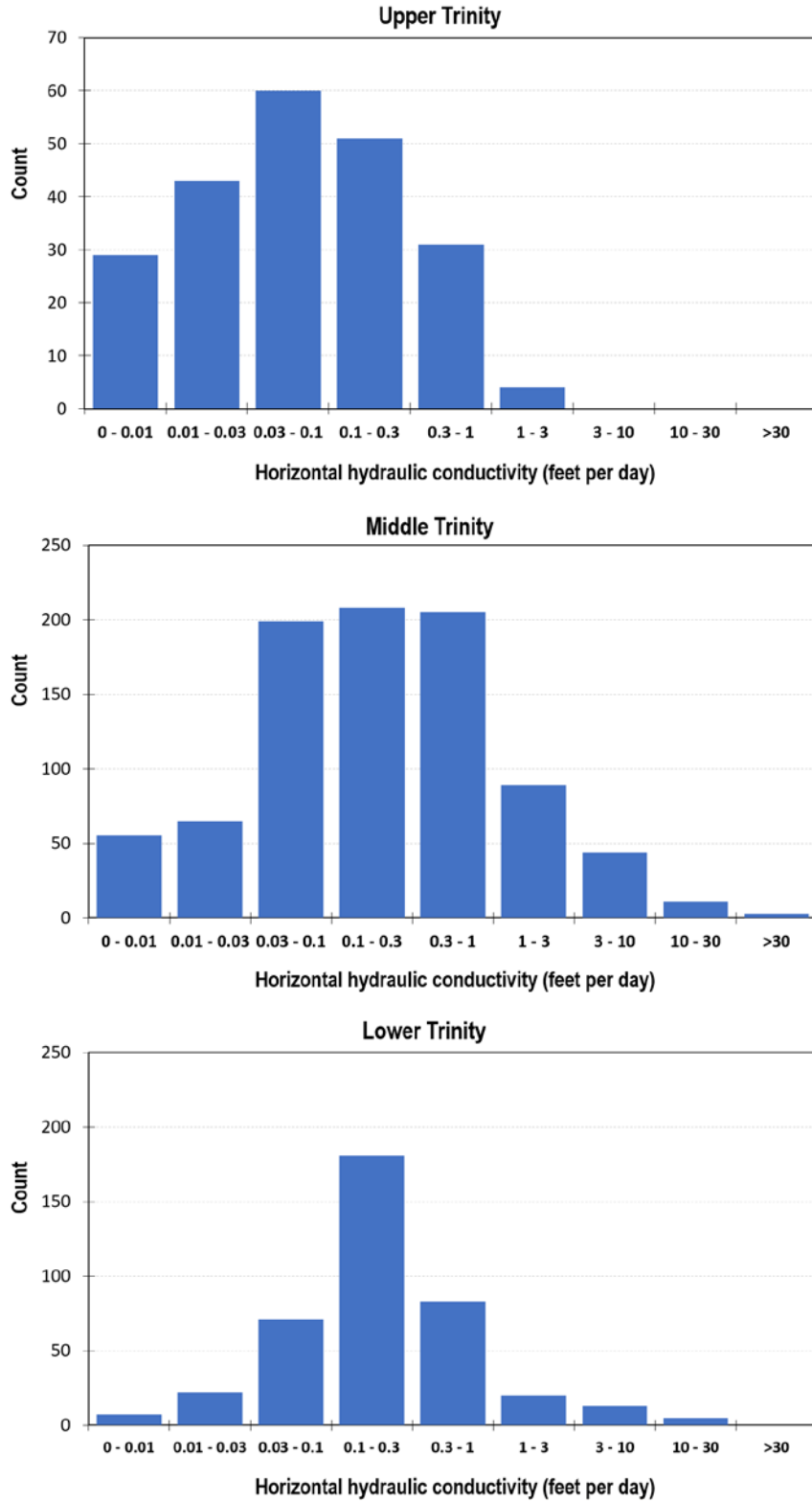

Figure 4.5.14 Histogram of horizontal hydraulic conductivity in feet per day for (a) Upper Trinity hydrostratigraphic unit, (b) Middle Trinity hydrostratigraphic unit, and (c) Lower Trinity hydrostratigraphic unit.

Conceptual Model Report for the Hill Country Trinity Aquifer
Groundwater Availability Model

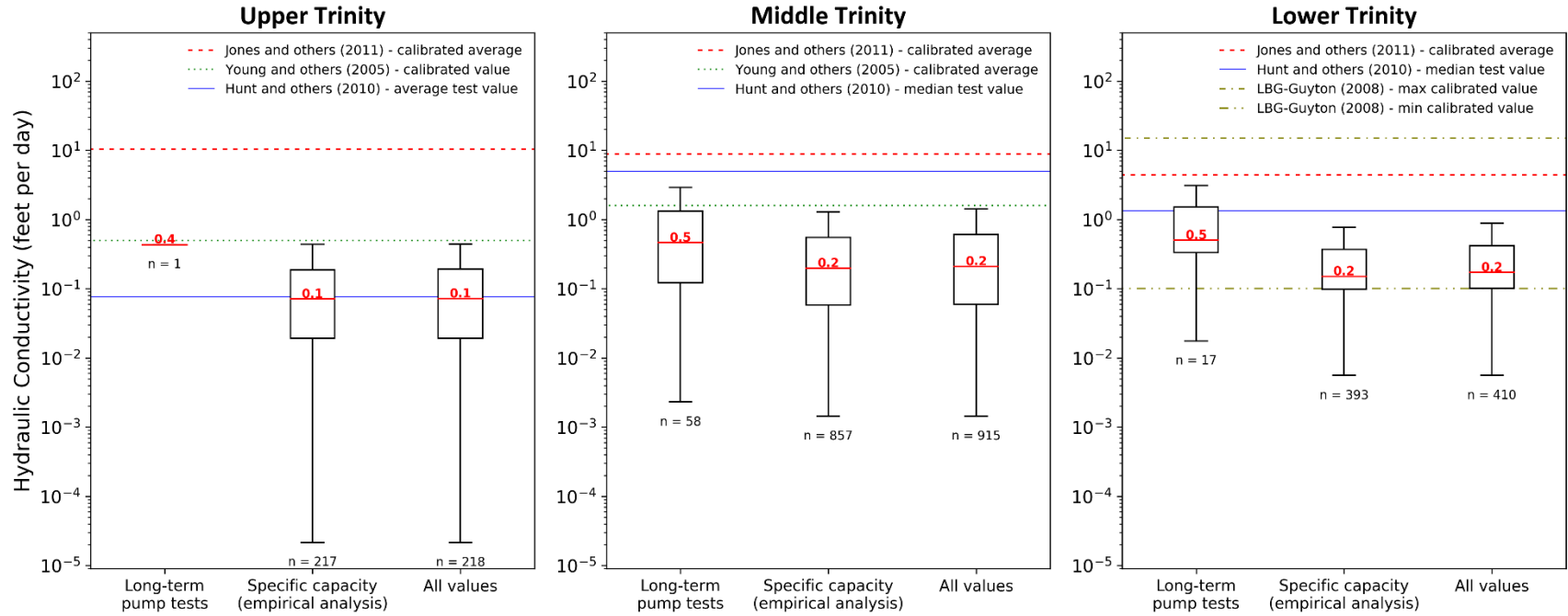
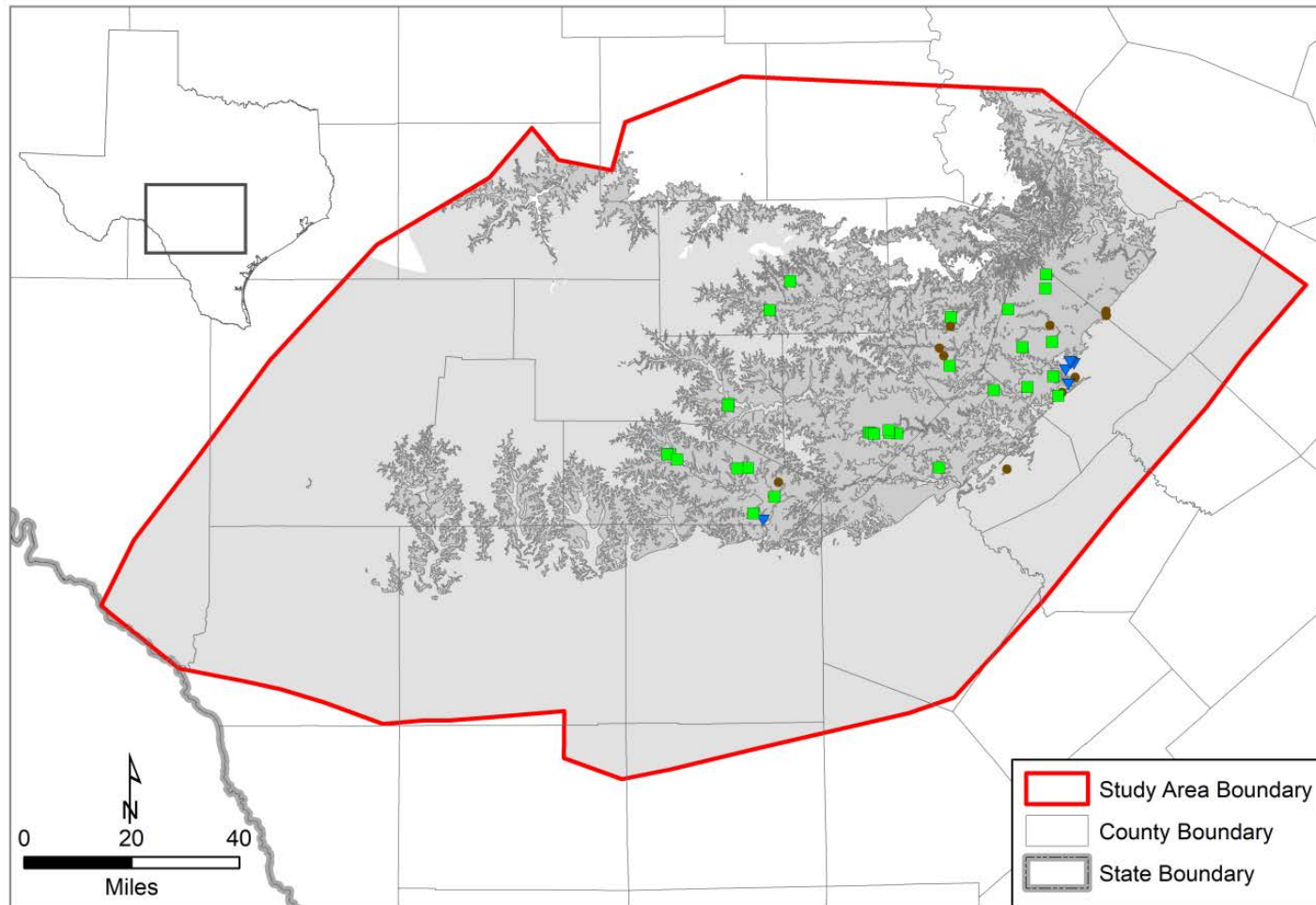

Figure 4.5.15 Comparison of calculated values and selected literature values for hydraulic conductivity by hydrostratigraphic

Conceptual Model Report for the Hill Country Trinity Aquifer
Groundwater Availability Model

unit.



Location of available Storativity data (by hydrostratigraphic unit)

- | | | |
|------------------|-----------------|---|
| ▲ Upper Trinity | ▼ Lower Trinity | ■ Outcrop of all Trinity hydrostratigraphic units |
| ■ Middle Trinity | ● mixed Trinity | ■ Extent of all Trinity hydrostratigraphic units |

Figure 4.5.16 Location of available storativity data by hydrostratigraphic unit in the study area

4.6 Discharge

Discharge from the HCT Aquifer occurs by: (i) spring discharge; (ii) inter-formational flow; and (iii) pumping. The first two are naturally occurring, the third is obviously not.

4.6.1 Springs

Springs present in the model domain are described in this section (Figure 4.6.1 and Figure 4.6.2). Spring discharge values in the Hill Country vary considerable as noted in Brune (1975), Johnson and Schindel (2008), and Musgrove and Crow (2012). Virtually all river baseflow within the HCT Aquifer domain is derived from springs discharging into river channels. Springs with significant flow are named (Figure 4.6.1). Most springs in river channels in the HCT Aquifer units are not named. With the exception of Jacob's Well, the named springs in the study area discharge from the Edwards group. Given the lack of springflow measurements, stream baseflow measurements are often used as a surrogate for spring discharge (Figure 4.4.2). This is particularly useful if a sufficient number of stream gain/loss measurements allow for accurate attribution of how much spring discharge occurs in a particular stream reach.

There are two general types of springs in the HCT Aquifer model domain. Springs located in upland regions are mostly the result of groundwater issuing at ground surface where an impermeable surface is exposed at ground surface. As described in Section 4.5.6, the tight low-permeability interbeds, such as those found in the upper and middle parts of the Trinity Aquifer, severely restrict vertical flow so that groundwater moves laterally along impermeable bedding. This type of spring tends to be found in river and stream channels which are the points of the lowest local elevation. These springs are identified by the surface geologic formation at the spring location (Figure 4.6.2).

The second category is springs along the Balcones Fault Zone that are sourced from formations at depth. The most prominent of these springs are Comal, San Marcos, Hidden Valley, Hueco, Jacobs Well, San Pedro, San Antonio, and Las Moras springs (Figure 4.6.1). There are additional locations in stream and river beds in the Balcones Fault Zone where groundwater from depth issues at the surface. These water features are commonly referred to as blue holes and provide local perennial pools of water. Examples can be seen in Helotes Creek and Frio River (Green and others, 2008). Discharge at these pools is not significant. Inclusion of these features in water-budget analyses is not recommended.

Representation of the springs as singular features in the model can be challenging because springs tend to have multiple points of discharge with different elevations. As a result, different points of discharge can cease flowing as groundwater-elevations drop. Elevations used for guidance are referred to as reference elevations due to this physical ambiguity (Table 4.6.1).

The composition of source water for spring systems can be useful when determining the capture area of the springs, however, minimal data on the chemistry of spring discharge are available. Parsing out source areas using tools such as water chemistry, tracer experiments, and water-budget analyses has proven to be useful in characterizing these systems (Hauwert, 2009). Identification of source areas can become more complicated if the sources of discharge vary with stage (Doctor and others, 2006). These complications appear to be more common in larger spring

systems, such as Comal, San Marcos, and Barton springs. Smaller spring systems with a limited number of discharge points or even a single point of discharge are more easily conceptualized. Within the study area, Pinto, Las Moras, San Pedro, San Antonio, Pleasant Valley, and Hueco springs are conceptualized as systems of limited complexity due to a relatively simple source area and a limited extent of discharge points, however, in reality, these springs may also have multiple points of discharge.

4.6.2 Pumping

Estimates of pumping discharge from the Trinity hydrostratigraphic units in the study area were developed for each county for the time period from 1980 through 2015. The following subsections describe (1) sources of historical pumping data, (2) approach to estimating rural domestic pumping, (3) estimates of specific historical pumping data for the Trinity hydrostratigraphic units, (4) a summary of historical pumping data for 1980 through 2015, (5) a discussion of water uses of the Trinity hydrostratigraphic units, and (6) the estimated spatial distribution of pumping.

4.6.2.1 Historical Pumping Data Sources

A search was conducted to identify sources of historical pumping estimates for the HCT Aquifer. This search included a literature survey, a request of water-use survey data from the TWDB, and requests of production data from groundwater conservation districts. An additional source of historical pumping data was the calculation of rural domestic pumping from census block data and estimated per capita water use, discussed in Section 4.6.2.2.

4.6.2.1.1 Literature Review Results

Several sources describing historical pumping from the Trinity hydrostratigraphic units in the study area were identified through the literature review. These include historical county reports documenting groundwater resources (Livingston, 1947; George, 1947; Reeves, 1967; Reeves, 1969; Alexander and Patman, 1969; Follett, 1973; Reeves and Small, 1973) and historical public water supply reports (Sundstrom and others, 1949; Broadhurst and others, 1950; Broadhurst and others, 1951). These literature values were of limited use for the current analysis. When pumping values are included in these sources, typically, only a one-time measurement, rather than a time series, is included. Most sources only include expected yields or water uses from a particular hydrostratigraphic unit. Some units are only described as “Trinity,” so it is difficult to assign pumping to the hydrostratigraphic units used in the current report. However, these literature sources are helpful in developing a probable timeline for the start of groundwater pumping from the Trinity hydrostratigraphic units in the current study area. Table 4.6.1 summarizes the year(s) of first recorded pumping, the hydrostratigraphic unit(s) associated with the pumping data, and the groundwater-use type associated with the pumping. As shown, pumping from the Trinity hydrostratigraphic units in Bandera, Bexar, Kerr and Kimble counties dates back to the 1940s and there is even a record of a Trinity well drilled in 1928 in Edwards County. While these literature sources can indicate a nominal start of pumping from the Trinity hydrostratigraphic units, it is difficult to extrapolate this information into usable data about the temporal and spatial distribution of pumping over the rest of the historical time period, for which little to no other data exists. Therefore, this information was used only indirectly in the current analysis. For instance, it was used in choosing the time period for pre-development water-level elevation contours (Section 4.2)

4.6.2.1.2 TWDB Water Use Survey Data

Estimates of historical pumping for 1980 and 1984 through 2015 are available from the TWDB historical groundwater pumpage database (TWDB, 2018a). These values are available for municipal, manufacturing, mining, power, irrigation, and livestock water-use categories by TWDB aquifer designation. These estimates have been developed by the TWDB as a water-use survey database to support state water planning and the TWDB GAM program and are considered the most reliable source of historical pumping information available. These are the primary data used in previous groundwater models in the study area (Mace and others, 2000; Anaya and Jones, 2009; Jones and others, 2011). A formal request for specific pumping data on a per-well basis was made to the TWDB. In response to that request, TWDB provided a dataset of water-use survey data with groundwater-use estimates for 1980 through 2015 that provides water-use estimates by well and by aquifer for all counties in the current study area (TWDB, 2017e).

Since they are derived from the same water-use survey data, the total values for these county-level (TWDB, 2018a) and well-specific (TWDB, 2017e) datasets are generally consistently post-2000. From 2000 onwards, both datasets include “non-surveyed estimates” for all water uses, in addition to the surveyed estimates. Since there is some uncertainty inherent in survey-reliant data, these non-surveyed estimates can help account for pumping that is unreported or under-reported in the survey data. However, while the county-wide pumping data (TWDB, 2018a) includes pre-2000 non-survey estimates, the per-well estimates (TWDB, 2017e) do not. For this reason, the county-wide pumping total values are considered more representative of county-wide pre-2000 pumping. An additional difference between the two datasets is that the per-well dataset (TWDB, 2017e) include values for the years 1981 through 1983 whereas the county-wide pumping dataset (TWDB, 2018a) does not. The current analysis therefore uses a combination of these two datasets to fill in data gaps as necessary.

In addition to the post-1980 groundwater pumpage database, TWDB also provides datasets for historical municipal and historical industrial water intake that provide data by water user from the 1950’s onwards (TWDB, 2018b). However, these data are provided by water-use location rather than the location of actual groundwater pumpage. For this reason, pumping values from this dataset were only considered if the listed water supplier was in the study area, not if the water user was in the study area. In addition, because industrial water users often use public or municipal suppliers, there is overlap between the industrial and municipal datasets. For this reason, only “self-supplied” industrial users could be considered. While less complete than the groundwater pumpage datasets (TWDB, 2017e, 2018a), the benefit of the historical municipal data (TWDB, 2018b) is the long historical record available. This database helps establish pumping start dates and some counties have data available over nearly 70 years. However, these data are not consistently available for all counties. Some county records appear to be incomplete, as they start much later than the expected start date of pumping based on the county reports and public water supply reports discussed in the previous section. Some records even start after the post-1980 historical groundwater pumpage database (TWDB, 2017e, 2018a) begins. For this reason, these data were not used to create pre-1980 groundwater pumping trends across the region, as they were considered much less certain than the post-1980 water-use survey datasets. A summary of the information available from this dataset is included in Table 4.6.2, as it could be helpful for investigating pumping of individual counties. Note that the start date from this dataset was not included if it occurred post-1980.

4.6.2.1.3 Groundwater Conservation District Data

The study area intersects twenty-three groundwater conservation districts (Figure 2.0.5). During stakeholder meetings and other outreach efforts for the current project, all districts were invited to submit relevant pumping data. A few districts were able to provide pumping records. In general, because most groundwater conservation districts only recently began monitoring activities, or in some cases, only recently were formed, groundwater conservation district data pertains to recent pumping within the past five to ten years, rather than historical records. A few datasets were only available as district-wide estimates or as limited numbers of individual well records and so could not be readily compared with the county-level data available from TWDB. In addition, pumping data at particular wells could not be used in most cases since there was not enough well location or completion information to assign these wells to the current project's hydrostratigraphic units. Since major water users are required to report to the TWDB water-use survey program as well as to local groundwater conservation districts, it is assumed that much of the information received from groundwater conservation districts is already incorporated in the TWDB historical groundwater pumpage database (TWDB, 2017e, 2018a).

Because most counties in the eastern portion of the study area fall within Groundwater Management Area 9, the joint-planning explanatory report for that region (GMA-9, 2016) includes the most comprehensive dataset of relevant county-level annual pumping estimates for the Trinity hydrostratigraphic units. These estimates for the year 2008 were originally developed and submitted by groundwater conservation districts to TWDB for the modeled pumping scenarios in Hutchison (2010), which was used for joint planning decision-making. These pumping values represent the best-available estimates of annual county-level pumping values by groundwater conservation districts in Groundwater Management Area 9. Since districts update pumping estimates more frequently based on field observations and also include exempt pumping from smaller users, these values are typically considered more representative and up-to-date than values in the TWDB Water Use Survey datasets (personal communication, Ron Fieseler GMA-9 Chairman, November 13, 2018). Unfortunately, these district-provided values were only available for one year (2008) and only include about half the counties considered in the current analysis, so they were of limited use in developing a historical time series of pumping over the entire current study area. However, since these values represent the best-available estimates directly from groundwater conservation districts, these values were used to check if the pumping values developed in the current study were reasonable for the counties of Groundwater Management Area 9.

4.6.2.2 Calculated Rural Domestic Pumping

Estimates of rural domestic pumping for the years 1990, 2000, and 2010 were developed using census block data from these years and an assumed per capita water use. Census block data for 1990, 2000, and 2010 were obtained from the IPUMS National Historical Geographic Information System (Manson and others, 2017) in the format of tables linked to census-block geographic information system (GIS) coverage. These data include the total population, as well as the rural and urban population by census block. The rural-domestic water use in each census block was calculated as the rural population times an estimated per capita water use. The per capita use was assumed to be 110 gallons per day (0.1232 acre-feet per year) based on the approximate median per capita water use in Texas between 1980 and 1997 (Hamlin and Anaya, 2006).

Conceptual Model Report for the Hill Country Trinity Aquifer
Groundwater Availability Model

For the purposes of this analysis, water used for rural domestic purposes was assumed to be supplied solely by groundwater. This was assumed because the high treatment cost associated with surface water for human consumption is likely to make groundwater the most common source of rural-domestic pumping. This analysis also assumed that rural domestic pumping in each hydrostratigraphic unit was confined to the outcrop of that unit and that all water used for rural domestic purposes in the outcrop area is supplied by groundwater solely from that hydrostratigraphic unit. This was assumed because rural-domestic wells are typically only drilled to the shallowest permeable unit to minimize drilling costs. The exception to this is the Upper Trinity hydrostratigraphic unit. Since this unit has low permeability and is thin throughout much of the HCT region, eighty percent of the pumping in this outcrop was assumed to actually be sourced from the Middle Trinity hydrostratigraphic unit. The census block coverage was clipped to the extent of the hydrostratigraphic unit outcrop. The ratio of the census-block area within the hydrostratigraphic unit outcrop to the total census-block area was considered equivalent to the ratio of rural-domestic pumping within the hydrostratigraphic unit to the total rural-domestic pumping within the census block. This ratio was used to calculate a weighted amount of rural-domestic pumping for the clipped census block. The weighted rural-domestic pumping in all clipped census blocks in a hydrostratigraphic unit in a county was summed to get the total rural-domestic pumping within the hydrostratigraphic unit for that county. This calculation of groundwater use for rural domestic purposes by year and by hydrostratigraphic unit can be summarized as:

$$RD_{HU} = \sum RurPop_{CB} \cdot AreaRatio_{\frac{out}{CB}} \cdot PerCapitaUse \quad (4.6.1)$$

where:

RD_{HU} = groundwater use from the hydrostratigraphic unit for rural domestic purposes (acre-feet per year),

$RurPop_{CB}$ = total rural population per census block

$AreaRatio_{out/CB}$ = ratio of the area of the census block falling within the hydrostratigraphic unit outcrop to the total census block area, and

$PerCapitaUse$ = per capita water use (acre-feet per year)

The estimated rural domestic pumping from each hydrostratigraphic unit for the years 1990, 2000, and 2010 was calculated using Equation 4.6.1. Figure 4.6.3, Figure 4.6.4, and Figure 4.6.5 show distributions of rural-domestic pumping as acre-feet per year per census block in 1990, 2000, and 2010, respectively. Census blocks with no rural population are excluded from this analysis and appear as blank areas in the figures. In the western portion of the study area, these blank areas generally indicate census blocks with no recorded population at all. In the eastern portion of the study area, these blank areas generally indicate the presence of cities. There are a few inconsistencies between years that reflect minor changes in the census block extents or census methodology, however, in general, there is a trend of declining rural population over time in the study area. As shown, the Trinity hydrostratigraphic units contribute little to no rural domestic pumping in the western portion of the study area, as the Edwards hydrostratigraphic unit crops out in this region. The exception is an area of Middle Trinity hydrostratigraphic unit outcrop in Kimble County. In the HCT Aquifer region, the Upper and Middle Trinity hydrostratigraphic units provide most of the rural-domestic pumping. As the Lower Trinity hydrostratigraphic unit is deeper and does not crop out anywhere except a small area in Travis

and Burnet counties, this unit is assumed to provide very little of the rural-domestic pumping in the area.

Rural population estimates by census block were not available for non-census years or for 1980. For the purposes of this analysis then, rural domestic pumping for the years 1980 through 1995 were assumed to be the same as the estimated rural domestic pumping from 1990. Rural domestic pumping for the years 1996 through 2005 were assumed to be the same as the estimated rural domestic pumping from 2000. Rural domestic pumping for the years 2006 through 2015 were assumed to be the same as the estimated rural domestic pumping from 2010.

4.6.2.3 Estimation of Historical Pumping Data by Hydrostratigraphic Unit

Total annual pumping values by aquifer and by county for 1980 and 1984 through 2015 were sourced from the TWDB historical groundwater pumpage county-level database (TWDB, 2018a). The TWDB well-specific water-use survey data (TWDB, 2017e) does provide estimates for the years 1981, 1982, and 1983. However, these estimates are likely incomplete, as they are much lower than values in 1980 and 1984 provided in the county-level dataset (TWDB, 2018a). Therefore, to fill in missing data in the years 1981, 1982, and 1983, pumping was assumed to increase or decrease linearly between 1980 and 1984 pumping values from the county-level dataset (TWDB, 2018a). The one exception is Bexar County, where TWDB well-specific water-use survey data (TWDB, 2017e) indicated higher pumping values than this linear estimate. Therefore, the values from the TWDB well-specific water-use survey data (TWDB, 2017e) were used to fill in the missing years in Bexar County.

The estimated historical pumping data obtained from TWDB (2017e, 2018a) provide groundwater use by TWDB aquifer designation. The Upper, Middle, and Lower Trinity hydrostratigraphic units discussed in the current report are not officially-recognized TWDB aquifers. Rather they comprise portions of two TWDB-designated major aquifers: the Trinity Aquifer and the Edwards-Trinity (Plateau) Aquifer. Therefore, it was necessary to determine what portion of pumping from these aquifers comes from the Upper Trinity, Middle Trinity, and Lower Trinity hydrostratigraphic units.

Total pumping from the Edwards-Trinity (Plateau) Aquifer by county and by year was distributed to the Edwards, Upper Trinity, Middle Trinity and Lower Trinity hydrostratigraphic units by percentages based on number of wells. For each hydrostratigraphic unit, this percentage was determined by the number of wells completed fully in that hydrostratigraphic unit compared to the total number of wells completed fully in any of the component hydrostratigraphic units of the Edwards-Trinity (Plateau) Aquifer. For counties intersecting both the Edwards-Trinity (Plateau) Aquifer and the Trinity Aquifer, only wells falling in the footprint of the Edwards-Trinity (Plateau) Aquifer were considered, rather than total wells in the county. For each year, this calculation only includes wells constructed during or before that particular year. At the beginning of the record, if there were no wells counted for a year, but pumping was reported, the distribution from the earliest year with well counts was used. This distribution of Edwards-Trinity (Plateau) Aquifer pumping by year and by hydrostratigraphic unit in a particular county can be summarized as:

$$Pump_{HU(ETP)} = WellRatio_{\frac{HU}{ETP}} \cdot Pump_{ETP} \quad (4.6.2)$$

where:

Conceptual Model Report for the Hill Country Trinity Aquifer
Groundwater Availability Model

$Pump_{HU(ETP)}$ = total annual pumping sourced from the hydrostratigraphic unit (acre-feet per year) in the extent of the Edwards-Trinity (Plateau) Aquifer in the county,
 $WellRatio_{HU/ETP}$ = ratio of the wells completed fully in the hydrostratigraphic unit to the total number of wells completed fully in any of the component hydrostratigraphic units of the Edwards-Trinity (Plateau) Aquifer, and
 $Pump_{ETP}$ = total pumping sourced from the Edwards-Trinity (Plateau) Aquifer (acre-feet per year) in the county.

Total pumping from the Trinity Aquifer by county and by year was distributed to the Upper Trinity, Middle Trinity and Lower Trinity hydrostratigraphic units by percentages based on number of wells. For each hydrostratigraphic unit, this percentage was determined by the number of wells completed fully in that hydrostratigraphic unit compared to the total number of wells completed fully in any of the component hydrostratigraphic units of the Trinity Aquifer. For counties intersecting both the Edwards-Trinity (Plateau) Aquifer and the Trinity Aquifer, only wells falling in the footprint of the Trinity Aquifer were considered, rather than total wells in the county. For each year, this calculation only includes wells constructed during or before that particular year. At the beginning of the record, if there were no wells counted for a year, but pumping was reported, the distribution from the earliest year with well counts was used. This distribution of Trinity Aquifer pumping by year and by hydrostratigraphic unit in a particular county can be summarized as:

$$Pump_{HU(T)} = WellRatio_{\frac{HU}{T}} \cdot Pump_T \quad (4.6.3)$$

where:

$Pump_{HU(T)}$ = total annual pumping sourced from the hydrostratigraphic unit (acre-feet per year) in the extent of the Trinity Aquifer in the county,
 $WellRatio_{HU/T}$ = ratio of the wells completed fully in the hydrostratigraphic unit to the total number of wells completed fully in any of the component hydrostratigraphic units of the Trinity Aquifer, and
 $Pump_T$ = total pumping sourced from the Trinity Aquifer (acre-feet per year) in the county.

Bandera, Blanco, Gillespie, Kendall, Kerr, Real, Uvalde counties intersected both the Edwards-Trinity (Plateau) and Trinity aquifers. For these counties, total pumping from each hydrostratigraphic unit was considered to be the sum of the pumping sourced from the hydrostratigraphic unit from both the Edwards-Trinity (Plateau) and Trinity aquifer extents. This calculation can be summarized as:

$$Pump_{HU} = Pump_{HU(ETP)} + Pump_{HU(T)} \quad (4.6.4)$$

where:

$Pump_{HU}$ = total annual pumping sourced from the hydrostratigraphic unit (acre-feet per year) in the county,
 $Pump_{HU(ETP)}$ = total annual pumping sourced from the hydrostratigraphic unit (acre-feet per year) in the extent of the Edwards-Trinity (Plateau) Aquifer in the county,
 $Pump_T$ = total pumping sourced from the Trinity Aquifer (acre-feet per year) in the county.

Conceptual Model Report for the Hill Country Trinity Aquifer
Groundwater Availability Model

This methodology does assume that every well constructed before a certain date remains in operation at that date. This may erroneously include some wells that were plugged or retired over time. This methodology also does not account for wells screened over multiple hydrostratigraphic units or for differences in transmissivity between hydrostratigraphic units that can control the productivity of individual wells. However, because early wells would have preferentially been drilled in the most transmissive units, the number of wells drilled in each hydrostratigraphic unit over time is considered a reasonable proxy for the transmissivity-controlled production from each hydrostratigraphic unit over time. Table 4.6.3 provides the calculated percentages of county-wide Trinity Aquifer and Edwards-Trinity (Plateau) Aquifer pumping sourced from each hydrostratigraphic unit by decade.

4.6.2.4 Summary of Historical Pumping Estimates for 1980 through 2015

The historical pumping estimates calculated from TWDB water-use survey data (Section 4.6.2.1) were combined with the calculated rural domestic pumping estimates (Section 4.6.2.2) to obtain an estimate of total historical pumping for the time period from 1980 through 2015.

Table 4.6.4 provides the estimated amount of historical pumping in acre-feet from each Trinity hydrostratigraphic unit by county for the years 1980, 1990, 2000, and 2010. Figure 4.6.6 and Figure 4.6.7 show time series of the estimated amount of historical pumping sourced from the Trinity hydrostratigraphic units for counties in the western/west-central portion and eastern/east-central portion of the study area, respectively. Each chart shows the division of pumping between the Trinity hydrostratigraphic units only. Values for counties in the extent of the Edwards-Trinity (Plateau) Aquifer exclude any Edwards-Trinity (Plateau) Aquifer pumping that is sourced from the Edwards hydrostratigraphic unit. The years on the x-axis for all charts are 1980 to 2015. The scale on the y-axis is the same for charts in the same figure except for Bexar County which had much higher pumping than the rest of the counties in the study area. Each chart also indicates whether the total pumping was derived from TWDB estimates for the Edwards-Trinity (Plateau) Aquifer, the Trinity Aquifer, or a combination of both.

In the western portion of the study area, very little county pumping is sourced from the Trinity hydrostratigraphic units. This is due to both low overall pumping in these counties as well as the fact that most of the Edwards-Trinity (Plateau) Aquifer pumping in this region is sourced from the shallow and more permeable Edwards hydrostratigraphic unit rather than the underlying Trinity hydrostratigraphic units. Of the pumping from the Trinity hydrostratigraphic units, the earliest pumping was sourced from the Upper Trinity hydrostratigraphic unit, likely because it is the shallowest and easiest to access beneath the Edwards hydrostratigraphic unit. This remains the main source of Trinity pumping in Edwards and Kinney counties. Over time, the amount of pumping sourced from the Middle Trinity and Lower Trinity hydrostratigraphic units has increased slightly in Uvalde and Real counties, reflecting increasing numbers of wells drilled into these deeper units. The Middle Trinity hydrostratigraphic unit has been the main source of Trinity pumping in Kimble and Medina counties over time, likely because it is shallower and crops out in that area. Most of the counties in the region show at least some increase in groundwater pumping during the 2011 drought.

County pumping sourced from the Trinity hydrostratigraphic units increases from west to east, as more of each county intersects the Trinity Aquifer rather than the Edwards-Trinity (Plateau)

Conceptual Model Report for the Hill Country Trinity Aquifer
Groundwater Availability Model

Aquifer. Bandera, Blanco, Kendall, Kerr, and Gillespie counties intersect both aquifers and show much higher pumping from Trinity hydrostratigraphic units than western counties that only intersect the Edwards-Trinity (Plateau) Aquifer. The Middle Trinity hydrostratigraphic unit is the main source of Trinity pumping in these counties. However, the amount of pumping from the Lower Trinity hydrostratigraphic unit has increased in Kendall, Blanco, Kerr and Bandera counties, particularly after about 2005. Kerr and Gillespie counties also saw an increase in the pumping sourced from the Upper Trinity hydrostratigraphic unit around the same time period. All counties in this region show a spike in groundwater pumping during the 2011 drought.

County pumping sourced from the Trinity hydrostratigraphic units is highest in the eastern portion of the study area, with the highest total county pumping in Bexar and Travis counties. These values reflect the high demand from populations near the large cities of San Antonio in Bexar County and Austin in Travis County. Comal and Hays counties, which fall in the fast-developing area between these two cities, also show increasing pumping values over time that reflect the high population growth in that region. The Middle Trinity hydrostratigraphic unit is the main source of Trinity pumping in these counties. However, the amount of pumping from the Lower Trinity hydrostratigraphic unit has increased over time, particularly after about 2005. This proportion has increased most dramatically in Comal County, where the amount of recent pumping sourced from the Lower Trinity hydrostratigraphic is as much or more than the amount sourced from the Middle Trinity hydrostratigraphic unit. All counties in this region show a spike in groundwater pumping during the 2011 drought.

The estimated total pumping values for the counties in Groundwater Management Area 9 were compared to the 2008 Trinity Aquifer pumping estimates provided by groundwater conservation districts (Hutchison, 2010). Table 4.6.5 compares the calculated total pumping values from all Trinity hydrostratigraphic units from both 2008 and 2010 to the district-provided values. In most counties, the calculated values for 2008 and 2010 are reasonably similar to or above the estimated district-provided values. The additional calculated pumping appears to be linked to rural-domestic pumping, implying that the current analysis conservatively overestimated rural-domestic pumping. In a few counties, such as Bexar and Kendall counties, the calculated 2008 value is lower than the district-provided values, but the calculated 2010 value is similar to or above the district-provided values. This lag might indicate that the TWDB datasets were not updated until the year of the Hutchison (2010) report. If so, these higher 2010 pumping values might need to be extended back a few years to match the district-provided estimates. While most calculated pumping values are reasonably similar to the district-provided estimates, two counties were not.

District-provided pumping is about two times the calculated pumping value in Kerr County and about three times the calculated pumping in Medina County. Since information on the distribution of this additional pumping was not available from districts in these counties, it is unclear why these values are so different. However, other than these two counties, the calculated pumping values appear reasonable compared to the district-provided estimates in Hutchison (2010). It is difficult to draw any firm conclusions based on a single year of district-provided pumping. However, Groundwater Management Area 9 will be updating their pumping estimates soon as part of the next joint-planning cycle (personal communication, Ron Fieseler GMA-9 Chairman, November 13, 2018) and future data may help explain the discrepancies noted here and provide additional information on pumping trends in the region.

4.6.2.5 Historical Pumping Estimates for 1980 through 2015 by Water Use

The TWDB historical groundwater pumping dataset (TWDB, 2018a) provides county pumping estimates by water use and by TWDB aquifer designation. Water uses include municipal, mining, manufacturing, steam electric power, irrigation, and livestock. As mentioned previously, the Upper Trinity, Middle Trinity, and Lower Trinity hydrostratigraphic units discussed in the current report are not officially-recognized TWDB aquifers. Rather they comprise portions of two TWDB-designated major aquifers: the Trinity Aquifer and the Edwards-Trinity (Plateau) Aquifer. For the purposes of this analysis, it was assumed that each Trinity hydrostratigraphic unit had the same water-use divisions as the major aquifer of which it was a component. The TWDB datasets do not provide estimates for rural domestic pumping. These values are based on the estimates from the current analysis (Section 4.6.2.2).

Stacked bar charts of pumping by use category were developed for all counties for the time period 1980 through 2015. Figure 4.6.8 and Figure 4.6.9 show time series of the water uses of pumping sourced from the Trinity hydrostratigraphic units for counties in the western/west-central portion and eastern/east-central portion of the study area, respectively. The charts do not show divisions between the Trinity hydrostratigraphic units, so pumping values represent combined pumping from the Trinity hydrostratigraphic units. The legend for each chart shows the water-use categories. The years on the x-axis for all charts are 1980 to 2015. The scale on the y-axis is the same for charts in the same figure except for Bexar County which had much higher pumping than the rest of the counties in the study area.

In the western counties of the study area, the majority of groundwater pumped from the Trinity hydrostratigraphic units is used for municipal, rural-domestic and livestock purposes. Very little Trinity groundwater is used for irrigation, except in Kinney County and small amounts in Real, Gillespie and Kimble counties. This is likely due to the Edwards hydrostratigraphic unit being shallower, more accessible and less saline than the Trinity hydrostratigraphic units in that region. There has been some increase in municipal pumping over time in Medina, Uvalde, and Real counties. In general, the increase in groundwater pumping during the 2011 drought in all counties in the region was driven by increases in municipal pumping in all counties in the region, with some increase in irrigation and livestock pumping in Gillespie County.

In the central counties of the study area that intersect both the Edwards-Trinity (Plateau) Aquifer and the Trinity Aquifer, the majority of groundwater pumped from the Trinity hydrostratigraphic units is used for municipal and rural-domestic purposes, with small amounts used for irrigation and livestock purposes. In general, the increase in groundwater pumping during the 2011 drought in all counties in the region was driven by increases in municipal pumping in all counties.

In the eastern counties of the study area, the majority of groundwater pumped from the Trinity hydrostratigraphic units is used for municipal and rural-domestic purposes. These values reflect the high demand from the large cities of San Antonio in Bexar County and Austin in Travis County. Comal and Hays counties, which fall in the fast-developing area between these two cities, also show large municipal and rural-domestic values that reflect the high population growth in that region. The Trinity hydrostratigraphic units also provide significant amounts of pumping for manufacturing and mining purposes in Bexar County. In general, the increase in groundwater pumping during the 2011 drought in all counties in the region was driven by increases in municipal pumping and less so by minor increases in irrigation and livestock use.

4.6.2.6 Spatial Distribution of Pumping by Water Use

In order to incorporate pumping into a numerical groundwater model, estimated historical pumping must be distributed spatially so that the volume of groundwater withdrawal from each grid block can be defined over time. The spatial distribution of pumping in each water-use category is assumed to be coincident with the location of wells for which the primary water-use matches the pumping category. However, while pumping from water-use categories with large individual users (municipal, industrial, power) can reasonably be assigned to actual well locations, there is great uncertainty in well locations for pumping from water-use categories with smaller and decentralized users (livestock, irrigation, rural-domestic). The following section provides recommendations for distributing pumping values spatially by water-use category.

Figure 4.1.1 shows the locations of municipal and industrial wells in the study area. Wells were considered municipal if they had a public water supply source number (from the Texas Commission on Environmental Quality), if the stated water use was “public supply” or “institution”, or if a city was listed as the owner. Wells were assumed to be industrial if the stated water use was “commercial” or “industrial.” This may not be a comprehensive dataset, as some well uses may be unlisted or listed erroneously in the source datasets. Wells that could be linked to the TWDB well-specific pumping dataset (TWDB, 2017e) are circled in the map. This is not a comprehensive dataset, as there were wells in the well-specific pumping dataset that could not be definitively matched with well locations either by public water supply source number or owner name. Therefore, additional information will likely be needed during model development to spatially assign pumping.

Land-cover datasets from the National Land Cover Dataset are available for the years 1992, 2001, 2006, and 2011 (Vogelmann and others, 2001; Homer and others, 2007; Fry and others, 2006; Homer and others, 2015)(Figure 4.6.11, Figure 4.6.12, and Figure 4.6.13). These figures show the distribution of rangeland and irrigated cropland for 1992, 2001, and 2011, respectively. Developed and urban areas are also included in the figures for reference. For the current analysis, rangeland was assumed to be a combination of the extents of the “shrubland” and “herbaceous” land-use categories. Irrigated cropland was assumed to be a combination of the extents of the “pasture/hay” and “cultivated crops” land-use categories. The category names are different for 1992 land cover dataset than for later datasets. For the 1992 dataset, rangeland was assumed to be a combination of the extents of the “shrubland” and “grassland/herbaceous” land-use categories. Irrigated cropland was assumed to be a combination of the extents of the “pasture/hay”, “orchards/vineyards”, “row crops” and “fallow” land-use categories. Note that more detailed land coverages, such as the National Agricultural Statistics Service crop data layers, are available in the area. However, these are generally only available for the past five to ten years and so, the National Land Cover Dataset coverages, while less detailed, are considered more useful since they are available for a longer time period.

The recommended spatial distribution for rural domestic pumping was discussed previously and shown in Figure 4.6.3, Figure 4.6.4, and Figure 4.6.5 for the years 1990, 2000, and 2010, respectively. This spatial distribution strategy is based on the rural population by census block falling within the outcrop of each hydrostratigraphic unit.

Conceptual Model Report for the Hill Country Trinity Aquifer
Groundwater Availability Model

Table 4.6.1 Initial reference elevation, calibrated elevation and calibrated conductivity of springs and points of discharge. Locations and elevations taken from TWDB GWDB for all springs except Pleasant Valley Spring. Pleasant Valley Spring location was extracted from a georeferenced Barton Springs Central Texas Water Map (BSEACD, 2017) and elevation was extracted from the DEM used in this study.

Spring Name	Latitude	Longitude	Elevation (feet, msl)
San Marcos Spring	29.893	-97.93	570
Comal Springs	29.7129	-98.1378	582.8
Hueco Springs	29.7593	-98.1408	660
Pleasant Valley Springs	30.0152	-98.2071	924
San Antonio Springs	29.4661	-98.4686	685
San Pedro Springs	29.4452	-98.5019	660
Las Moras Springs	29.3094	-100.4206	1105
Barton Springs	30.2635	-97.7713	462.34
Jacob's Well	30.0355	-98.1297	922.84
Cold Springs	30.0916	-98.403	1280

Conceptual Model Report for the Hill Country Trinity Aquifer
Groundwater Availability Model

Table 4.6.2 Summary of early recorded groundwater use from the Trinity hydrostratigraphic units in the study area.

County	County Report			Public Water Supply Report		TWDB Historical Municipal & Industrial Estimates (TWDB, 2018b)	
	First record of pumping	Trinity Water Source (HSU*)	Water Use ⁺	First record of pumping from “Trinity Group”	Water Use	First record of pumping from “Trinity Aquifer”	Water Use
Bandera	--	--	--	1940 ⁸	MUN	1955	MUN
Bexar	1947 ¹	Travis Peak (MT)	--	--	--	1958	IND
Blanco	1973 ²	Upper Glen Rose (UT) Lower Glen Rose (MT) Travis Peak (MT)	-- IRR MUN	--	--	1955	MUN
Comal	1947 ³	Upper Glen Rose (UT) Lower Glen Rose (MT) Hensell (MT)	-- -- DOM & STK	--	--	--	--
Edwards	--	--	--	1928 ⁹	MUN		
Gillespie	--	--	--	--		1955	IND
Hays	--	--	--	--		1965	MUN
Kendall	1967 ⁴	Glen Rose (UT) Glen Rose (MT) Hensell (MT) Cow Creek (MT)	-- -- -- --	--		1955	MUN & IND
Kerr	1969 ⁵	Hosston/Sligo (LT)	MUN	1940 ¹⁰	MUN	1958	MUN
Kimble	1964 ⁶	Hensell (MT)	--	1946 ¹⁰	MUN		
Travis	--			--		1955	MUN
Val Verde	1973 ⁷	Glen Rose (UT?)	STK	--			

* HSU = Hydrostratigraphic unit. Abbreviation key: UT = Upper Trinity; MT = Middle Trinity; LT = Lower Trinity

+ Water use abbreviation key: DOM = domestic; IRR = irrigation; IND = industrial; MUN = Municipal; STK = livestock

¹ Livingston (1947)

² Follet (1973)

³ George (1947)

⁴ Reeves (1967)

⁵ Reeves (1969)

⁶ Alexander and Patman (1969)

⁷ Reeves and Small (1973)

⁸ Broadhurst and others (1950)

⁹ Broadhurst and others (1951)

¹⁰ Sundstrom and others (1949)

Conceptual Model Report for the Hill Country Trinity Aquifer
Groundwater Availability Model

Table 4.6.3 Percentage of county-wide Trinity Aquifer and Edwards-Trinity (Plateau) Aquifer pumping sourced from each Trinity hydrostratigraphic unit by decade.

County	Year	Percent of Edwards-Trinity (Plateau) Aquifer pumping sourced from each hydrostratigraphic unit			Percent of Trinity Aquifer pumping sourced from each hydrostratigraphic unit		
		Upper Trinity	Middle Trinity	Lower Trinity	Upper Trinity	Middle Trinity	Lower Trinity
Bandera	1980	6.3%	12.5%	--	1.1%	83.0%	16.0%
Bandera	1990	6.3%	12.5%	--	0.7%	83.5%	15.8%
Bandera	2000	5.6%	11.1%	--	0.5%	82.0%	17.5%
Bandera	2010	13.0%	34.8%	4.3%	0.2%	77.4%	22.3%
Bexar	1980	--	--	--	--	94.3%	5.7%
Bexar	1990	--	--	--	--	90.4%	9.6%
Bexar	2000	--	--	--	--	91.0%	9.0%
Bexar	2010	--	--	--	0.1%	86.6%	13.3%
Blanco	1980	25.0%	75.0%	--	--	97.4%	2.6%
Blanco	1990	25.0%	75.0%	--	--	97.6%	2.4%
Blanco	2000	25.0%	75.0%	--	--	97.2%	2.8%
Blanco	2010	8.3%	83.3%	8.3%	0.4%	85.6%	14.0%
Burnet	1980	--	--	--	14.3%	57.1%	28.6%
Burnet	1990	--	--	--	11.1%	55.6%	33.3%
Burnet	2000	--	--	--	11.1%	55.6%	33.3%
Burnet	2010	--	--	--	3.3%	56.9%	39.8%
Comal	1980	--	--	--	--	79.8%	20.2%
Comal	1990	--	--	--	--	82.3%	17.7%
Comal	2000	--	--	--	--	77.9%	22.1%
Comal	2010	--	--	--	0.1%	46.7%	53.2%
Edwards	1980	8.5%	0.9%	0.4%	--	--	--
Edwards	1990	8.4%	0.8%	0.4%	--	--	--

Conceptual Model Report for the Hill Country Trinity Aquifer
Groundwater Availability Model

County	Year	Percent of Edwards-Trinity (Plateau) Aquifer pumping sourced from each hydrostratigraphic unit			Percent of Trinity Aquifer pumping sourced from each hydrostratigraphic unit		
		Upper Trinity	Middle Trinity	Lower Trinity	Upper Trinity	Middle Trinity	Lower Trinity
Edwards	2000	7.1%	0.6%	0.3%	--	--	--
Edwards	2010	14.9%	2.0%	0.7%	--	--	--
Gillespie	1980	11.9%	8.3%	--	2.7%	97.3%	--
Gillespie	1990	10.5%	16.7%	--	1.5%	98.5%	--
Gillespie	2000	10.1%	20.2%	--	1.2%	98.8%	--
Gillespie	2010	20.4%	27.8%	--	0.5%	99.5%	--
Hays	1980	--	--	--	--	88.1%	11.9%
Hays	1990	--	--	--	--	86.3%	13.7%
Hays	2000	--	--	--	--	80.9%	19.1%
Hays	2010	--	--	--	0.3%	67.1%	32.6%
Kendall	1980	--	100.0%	--	0.4%	96.0%	3.6%
Kendall	1990	--	100.0%	--	0.4%	95.7%	4.0%
Kendall	2000	--	100.0%	--	0.3%	94.2%	5.5%
Kendall	2010	13.5%	83.8%	--	0.3%	86.6%	13.1%
Kerr	1980	8.3%	46.7%	--	--	95.0%	5.0%
Kerr	1990	9.1%	55.8%	--	--	95.8%	4.2%
Kerr	2000	13.0%	50.0%	--	--	96.3%	3.7%
Kerr	2010	18.0%	48.7%	1.3%	0.2%	91.4%	8.4%
Kimble	1980	4.9%	46.2%	--	--	--	--
Kimble	1990	4.8%	46.5%	--	--	--	--
Kimble	2000	6.9%	40.8%	--	--	--	--
Kimble	2010	7.3%	43.2%	--	--	--	--
Kinney	1980	11.1%	--	--	--	--	--
Kinney	1990	11.1%	--	--	--	--	--
Kinney	2000	10.3%	--	--	--	--	--
Kinney	2010	6.7%	--	--	--	--	--

Conceptual Model Report for the Hill Country Trinity Aquifer
Groundwater Availability Model

County	Year	Percent of Edwards-Trinity (Plateau) Aquifer pumping sourced from each hydrostratigraphic unit			Percent of Trinity Aquifer pumping sourced from each hydrostratigraphic unit		
		Upper Trinity	Middle Trinity	Lower Trinity	Upper Trinity	Middle Trinity	Lower Trinity
Mason	1980	--	--	--	--	--	--
Mason	1990	--	--	--	--	--	--
Mason	2000	--	--	--	--	--	--
Mason	2010	--	50.0%	--	--	--	--
Medina	1980	--	--	--	--	100.0%	--
Medina	1990	--	--	--	--	100.0%	--
Medina	2000	--	--	--	--	100.0%	--
Medina	2010	--	--	--	1.1%	83.1%	15.7%
Real	1980	5.9%	5.9%	--	--	100.0%	--
Real	1990	23.8%	4.8%	--	--	100.0%	--
Real	2000	24.0%	4.0%	--	--	100.0%	--
Real	2010	27.1%	33.9%	2.3%	--	100.0%	--
Travis	1980	--	--	--	0.4%	70.7%	28.9%
Travis	1990	--	--	--	0.7%	68.9%	30.3%
Travis	2000	--	--	--	1.0%	67.6%	31.4%
Travis	2010	--	--	--	0.3%	60.2%	39.4%
Uvalde	1980	--	--	--	--	100.0%	--
Uvalde	1990	--	--	--	--	100.0%	--
Uvalde	2000	20.0%	--	--	--	75.0%	25.0%
Uvalde	2010	10.3%	55.1%	6.4%	2.0%	72.5%	25.5%
Val Verde	1980	21.9%	1.4%	--	--	--	--
Val Verde	1990	21.3%	1.3%	--	--	--	--
Val Verde	2000	19.3%	1.2%	--	--	--	--
Val Verde	2010	5.3%	0.3%	--	--	--	--
Williamson	1980	--	--	--	16.7%	41.7%	41.7%
Williamson	1990	--	--	--	11.1%	33.3%	55.6%

Conceptual Model Report for the Hill Country Trinity Aquifer
Groundwater Availability Model

County	Year	Percent of Edwards-Trinity (Plateau) Aquifer pumping sourced from each hydrostratigraphic unit			Percent of Trinity Aquifer pumping sourced from each hydrostratigraphic unit		
		Upper Trinity	Middle Trinity	Lower Trinity	Upper Trinity	Middle Trinity	Lower Trinity
Williamson	2000	--	--	--	8.7%	26.1%	65.2%
Williamson	2010	--	--	--	3.2%	20.3%	76.5%

Conceptual Model Report for the Hill Country Trinity Aquifer
Groundwater Availability Model

Table 4.6.4 Summary of pumping in acre-feet from Trinity hydrostratigraphic units by county for the years 1980, 1990, 2000, and 2010.

County	Year	Pumping by hydrostratigraphic unit (excluding rural domestic)			Estimated Rural domestic pumping by hydrostratigraphic unit			Total pumping (all water uses) by hydrostratigraphic unit		
		Upper Trinity	Middle Trinity	Lower Trinity	Upper Trinity	Middle Trinity	Lower Trinity	Upper Trinity	Middle Trinity	Lower Trinity
Bandera	1980	17	1050	200	162	961	--	179	2011	200
Bandera	1990	18	1533	289	162	961	--	180	2494	289
Bandera	2000	21	2336	495	274	1599	--	295	3935	495
Bandera	2010	31	2797	797	325	1870	--	356	4667	797
Bexar	1980	--	1284	78	223	1074	--	223	2358	78
Bexar	1990	--	6290	672	223	1074	--	223	7364	672
Bexar	2000	--	7253	721	250	1169	--	250	8422	721
Bexar	2010	21	13403	2051	171	735	--	192	14138	2051
Blanco	1980	--	364	10	71	508	1	71	872	11
Blanco	1990	--	455	11	71	508	1	71	963	12
Blanco	2000	1	421	12	96	709	2	96	1130	14
Blanco	2010	5	1214	199	116	902	1	121	2115	200
Burnet	1980	169	678	339	52	483	39	222	1161	378
Burnet	1990	116	580	348	52	483	39	168	1063	387
Burnet	2000	143	716	430	31	289	67	174	1005	497
Burnet	2010	69	1208	846	39	366	82	108	1574	928
Comal	1980	--	1512	384	199	1578	--	199	3090	384
Comal	1990	--	1482	319	199	1578	--	199	3060	319
Comal	2000	--	2255	640	252	2166	--	252	4421	640
Comal	2010	2	1148	1309	436	3598	--	438	4745	1309
Edwards	1980	111	11	6	18	--	--	130	11	6
Edwards	1990	72	7	4	18	--	--	90	7	4
Edwards	2000	69	6	3	16	--	--	86	6	3
Edwards	2010	108	14	5	14	--	--	123	14	5
Gillespie	1980	41	1468	--	30	1485	--	72	2952	--
Gillespie	1990	27	1675	--	30	1485	--	57	3160	--
Gillespie	2000	58	1730	--	40	668	--	98	2397	--
Gillespie	2010	220	1871	--	51	784	--	271	2655	--
Hays	1980	--	1502	203	285	1257	0.1	285	2759	203
Hays	1990	--	1556	247	285	1257	0.1	285	2813	247
Hays	2000	--	1809	427	426	1894	2	426	3704	429
Hays	2010	14	3342	1623	572	2497	3	586	5840	1626

Conceptual Model Report for the Hill Country Trinity Aquifer
Groundwater Availability Model

County	Year	Pumping by hydro-stratigraphic unit (excluding rural domestic)			Estimated Rural domestic pumping by hydro-stratigraphic unit			Total pumping (all water uses) by hydro-stratigraphic unit		
		Upper Trinity	Middle Trinity	Lower Trinity	Upper Trinity	Middle Trinity	Lower Trinity	Upper Trinity	Middle Trinity	Lower Trinity
Kendall	1980	7	1681	63	256	1324	--	263	3005	63
Kendall	1990	8	2162	90	256	1324	--	264	3486	90
Kendall	2000	9	3223	186	205	1369	--	214	4592	186
Kendall	2010	24	4243	632	253	1922	--	277	6165	632
Kerr	1980	29	5261	268	460	1840	--	489	7101	268
Kerr	1990	28	2918	122	460	1840	--	487	4758	122
Kerr	2000	104	3820	131	181	726	--	285	4546	131
Kerr	2010	253	4441	363	224	897	--	477	5339	363
Kimble	1980	54	510	--	0.1	155	--	54	665	--
Kimble	1990	41	393	--	0.1	155	--	41	548	--
Kimble	2000	40	237	--	0.1	39	--	40	276	--
Kimble	2010	46	271	--	0.1	44	--	46	315	--
Kinney	1980	1065	--	--	0.4	--	--	1066	--	--
Kinney	1990	773	--	--	0.4	--	--	774	--	--
Kinney	2000	1107	--	--	0.3	--	--	1107	--	--
Kinney	2010	82	--	--	0.1	--	--	82	--	--
Mason	1980	--	--	--	--	2	--	--	2	--
Mason	1990	--	--	--	--	2	--	--	2	--
Mason	2000	--	--	--	--	2	--	--	2	--
Mason	2010	--	6	--	--	2	--	--	8	--
Medina	1980	--	68	--	27	--	--	27	68	--
Medina	1990	--	71	--	27	--	--	27	71	--
Medina	2000	--	42	--	46	--	--	46	42	--
Medina	2010	4	298	56	130	--	--	134	298	56
Real	1980	21	21	--	182	--	--	202	21	--
Real	1990	144	29	--	182	--	--	326	29	--
Real	2000	61	21	--	221	--	--	282	21	--
Real	2010	203	275	17	242	--	--	444	275	17
Travis	1980	11	1901	778	553	2509	3	564	4410	781
Travis	1990	23	2081	916	553	2509	3	576	4589	919
Travis	2000	20	1263	586	457	2263	5	476	3526	591
Travis	2010	29	5301	3470	480	2472	7	509	7773	3477
Uvalde	1980	--	--	--	37	--	--	37	--	--
Uvalde	1990	--	--	--	37	--	--	37	--	--

Conceptual Model Report for the Hill Country Trinity Aquifer
Groundwater Availability Model

County	Year	Pumping by hydro-stratigraphic unit (excluding rural domestic)			Estimated Rural domestic pumping by hydro-stratigraphic unit			Total pumping (all water uses) by hydro-stratigraphic unit		
		Upper Trinity	Middle Trinity	Lower Trinity	Upper Trinity	Middle Trinity	Lower Trinity	Upper Trinity	Middle Trinity	Lower Trinity
Uvalde	2000	82	37	12	42	--	--	125	37	12
Uvalde	2010	57	461	96	52	--	--	110	461	96
Val Verde	1980	367	23	--	--	--	--	367	23	--
Val Verde	1990	899	56	--	--	--	--	899	56	--
Val Verde	2000	3203	200	--	--	--	--	3203	200	--
Val Verde	2010	638	32	--	--	--	--	638	32	--
Williamson	1980	694	1735	1735	79	--	--	772	1735	1735
Williamson	1990	566	1698	2830	79	--	--	645	1698	2830
Williamson	2000	147	440	1099	121	--	--	268	440	1099
Williamson	2010	100	633	2383	167	--	--	267	633	2383

Conceptual Model Report for the Hill Country Trinity Aquifer
Groundwater Availability Model

Table 4.6.5 Pumping in acre-feet from Trinity hydrostratigraphic units by county compared to 2008 pumping estimates in Groundwater Management Area 9.

County	Total annual pumping from the Trinity hydrostratigraphic units (acre-feet)		
	Current Study		Hutchison (2010)
	2008	2010	2008
Bandera	5,299	5,819	4,370
Bexar	10,926	16,381	15,000
Blanco	2,097	2,436	1,554
Comal	8,304	6,492	6,186
Hays	6,742	8,051	5,665
Kendall	5,499	7,074	6,685
Kerr	6,079	6,179	12,010
Medina	350	488	1,500
Travis	6,420	11,759	5,518

Conceptual Model Report for the Hill Country Trinity Aquifer
Groundwater Availability Model

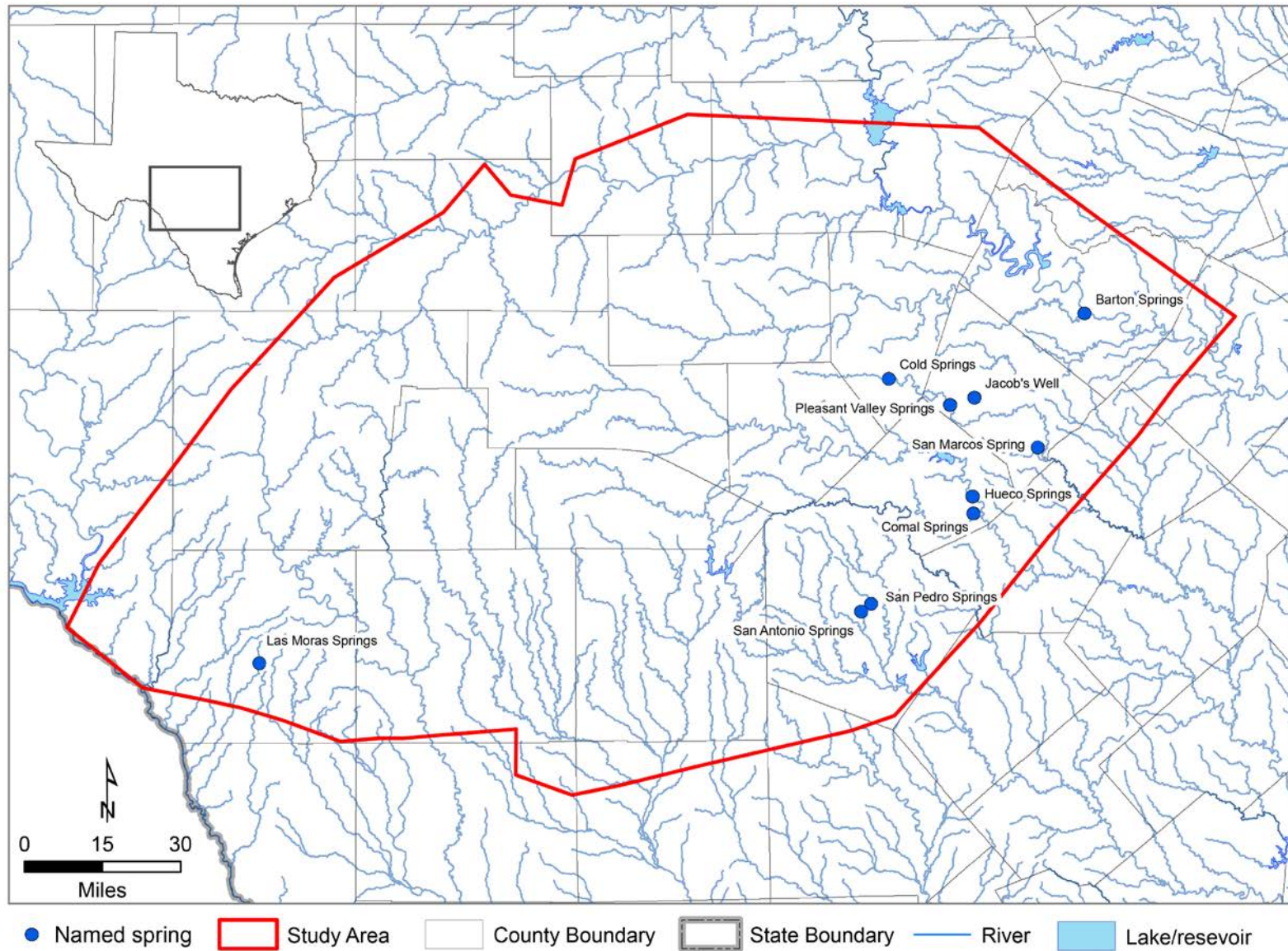

Figure 4.6.1 Selected named springs in the study area.

Conceptual Model Report for the Hill Country Trinity Aquifer
Groundwater Availability Model

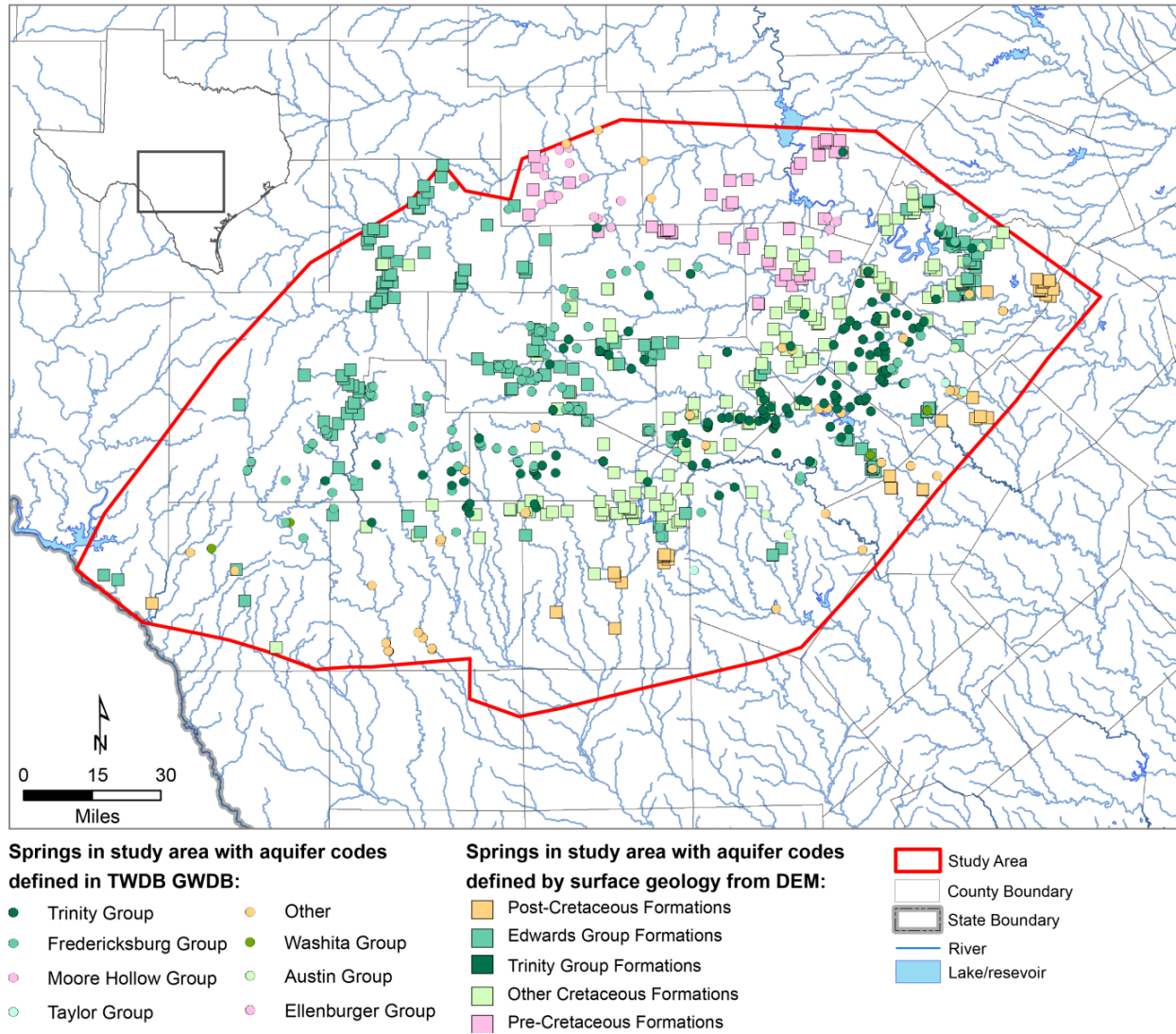

Figure 4.6.2 Springs located in study area. Circle symbology indicates the geological group from which the spring discharges water as specified in the TWDB GWDB. Springs in the TWDB GWDB which did not have a discharge unit specified were assigned the unit of the surface geology at that location according to the GAT.

Conceptual Model Report for the Hill Country Trinity Aquifer
Groundwater Availability Model

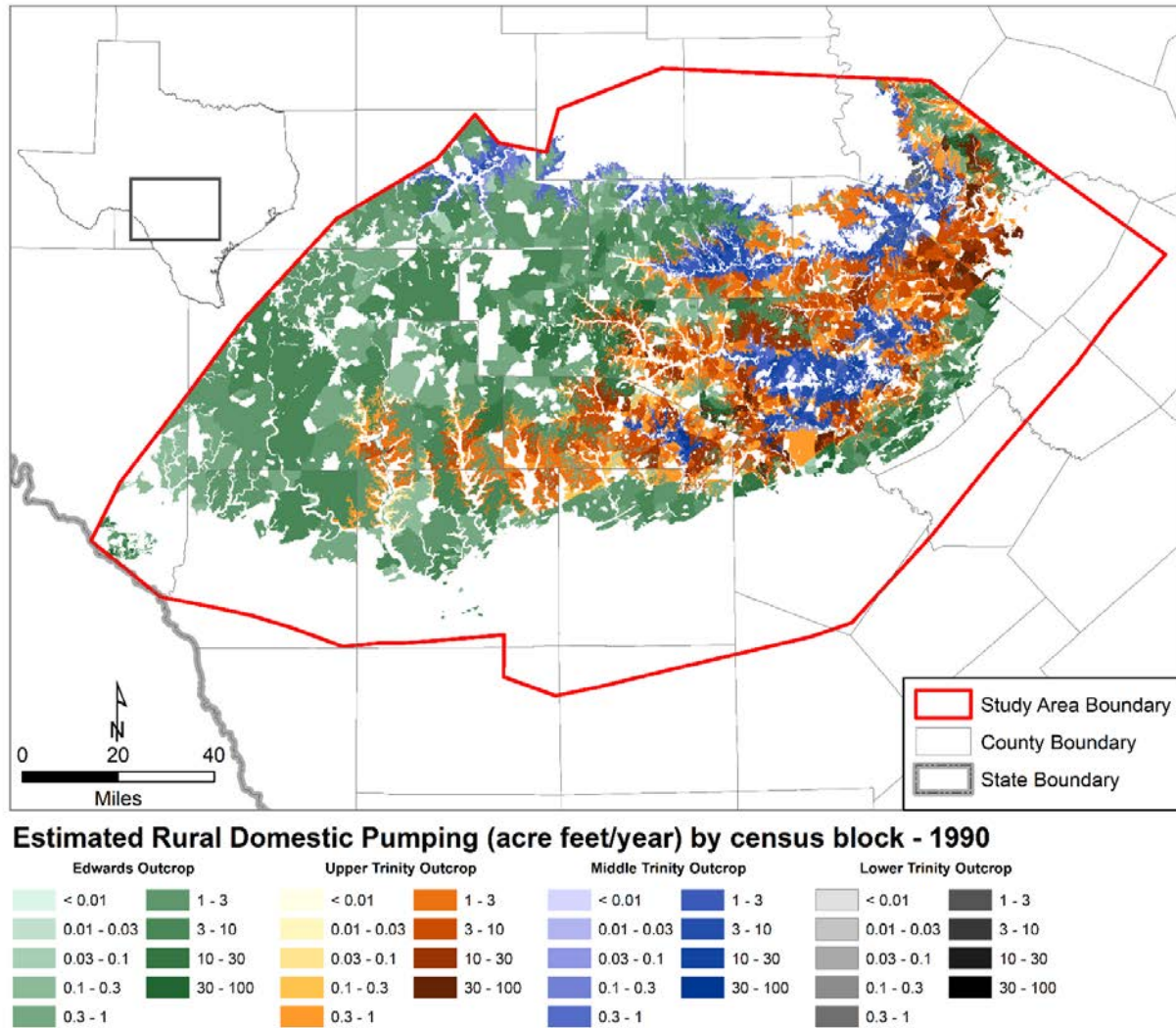

Figure 4.6.3 Estimated rural domestic pumping by hydrostratigraphic unit outcrop in the study area, based on 1990 census block rural population data (Manson and others, 2017).

Conceptual Model Report for the Hill Country Trinity Aquifer
Groundwater Availability Model

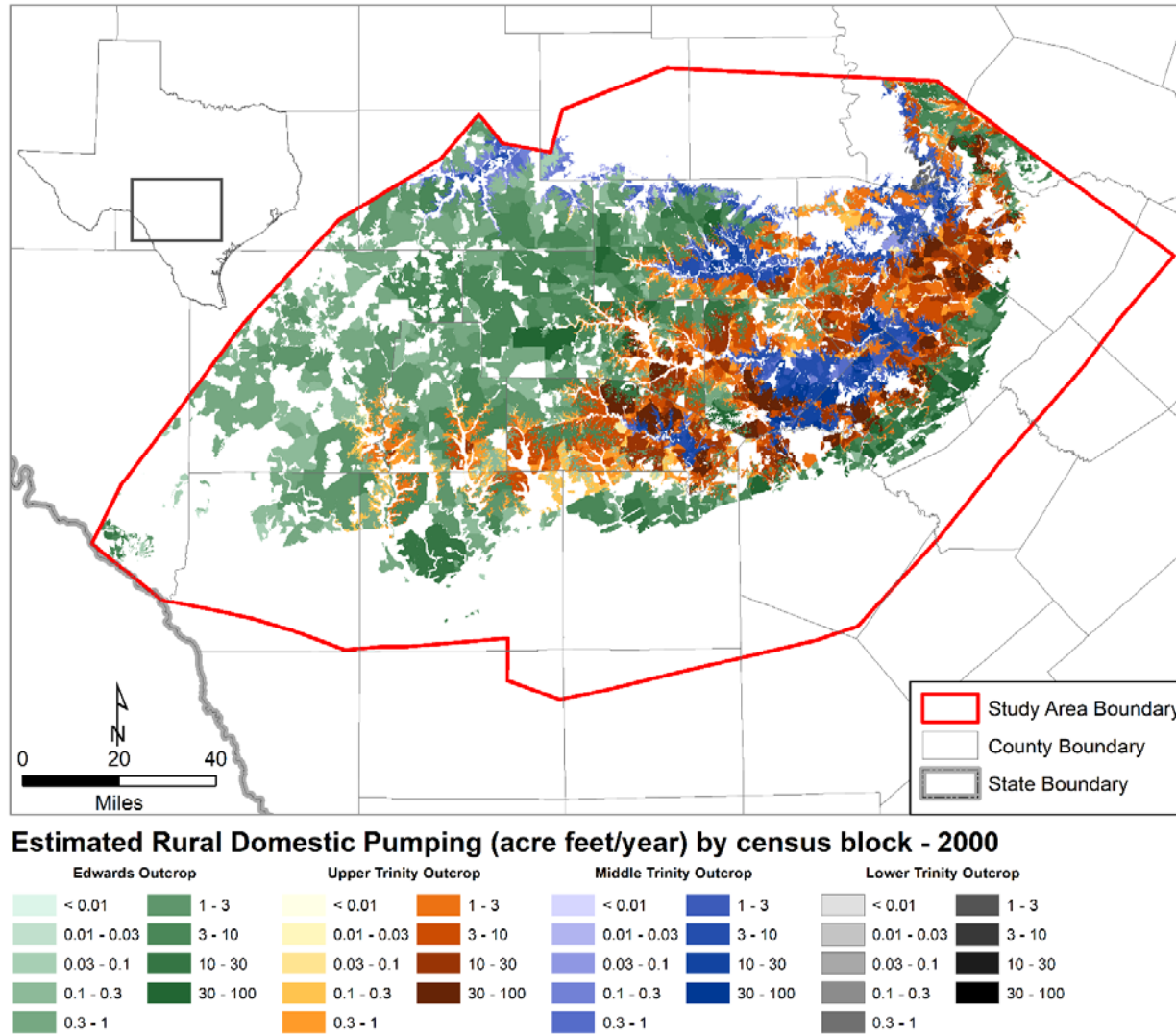

Figure 4.6.4 Estimated rural domestic pumping by hydrostratigraphic unit outcrop in the study area, based on 2000 census block rural population data (Manson and others, 2017).

Conceptual Model Report for the Hill Country Trinity Aquifer
Groundwater Availability Model

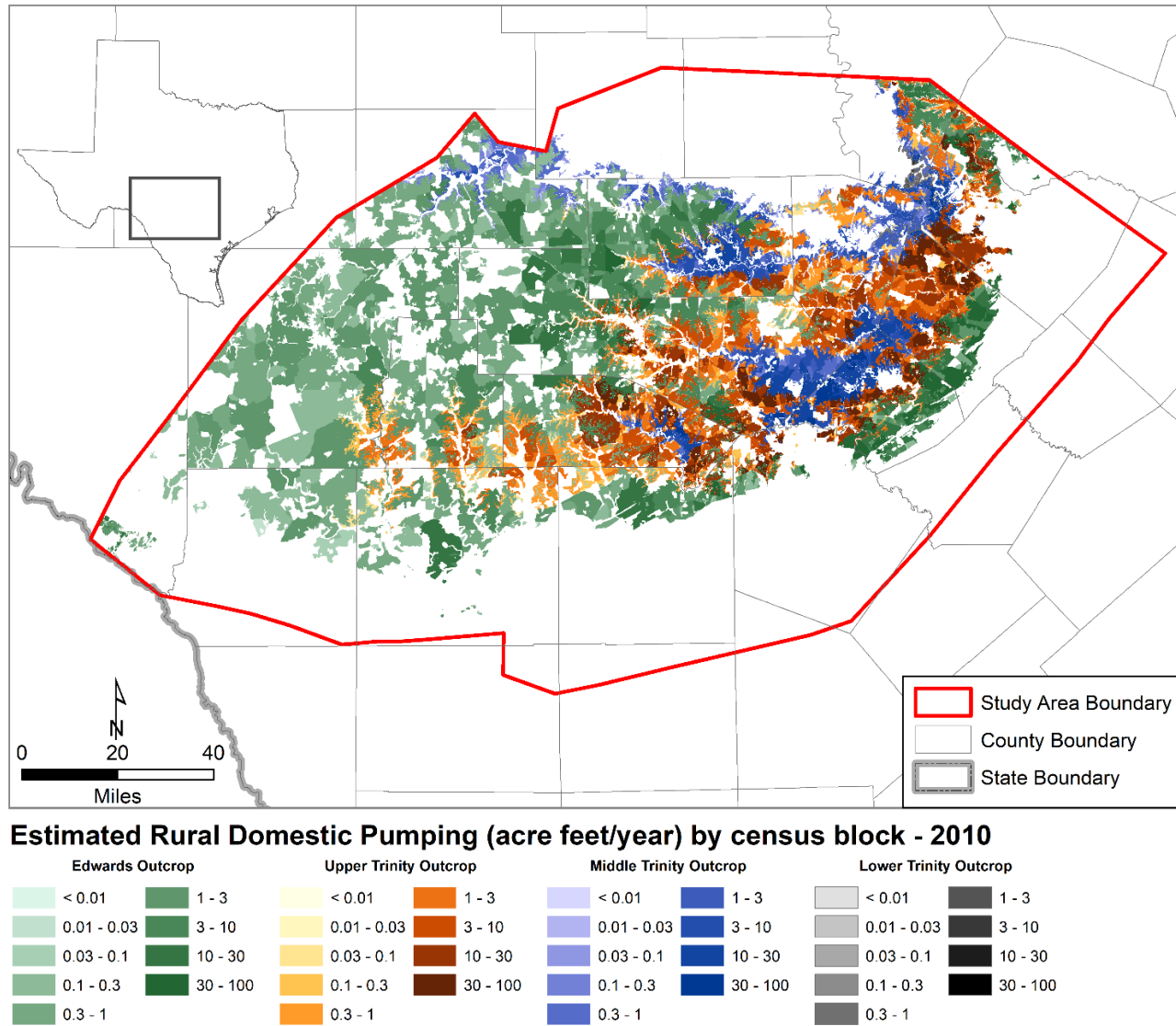

Figure 4.6.5 Estimated rural domestic pumping by hydrostratigraphic unit outcrop in the study area, based on 2010 census block rural population data (Manson and others, 2017).

Conceptual Model Report for the Hill Country Trinity Aquifer Groundwater Availability Model

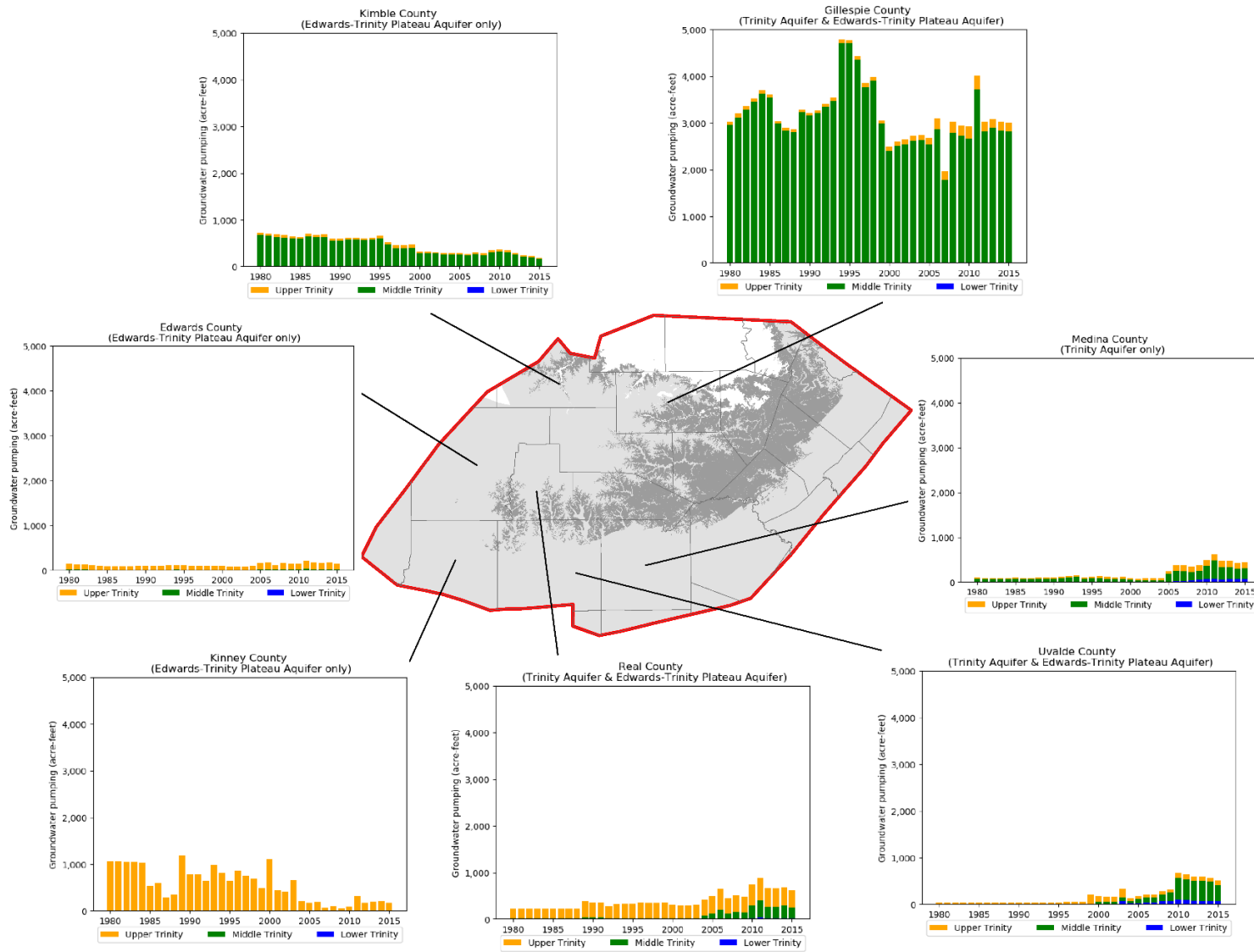

Figure 4.6.6 Estimated total pumping by hydrostratigraphic unit in the western/west-central counties of the study area.

Conceptual Model Report for the Hill Country Trinity Aquifer Groundwater Availability Model

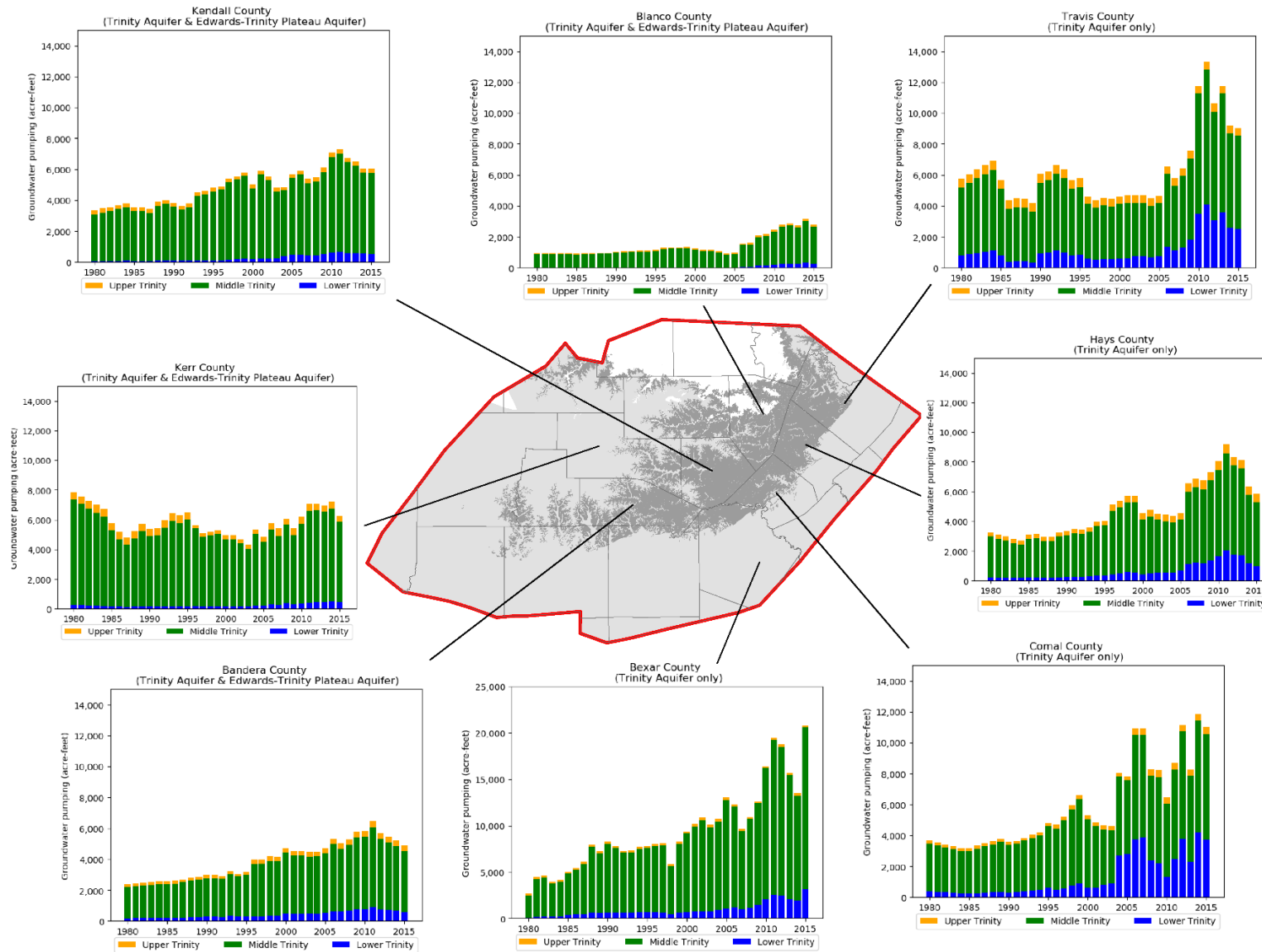
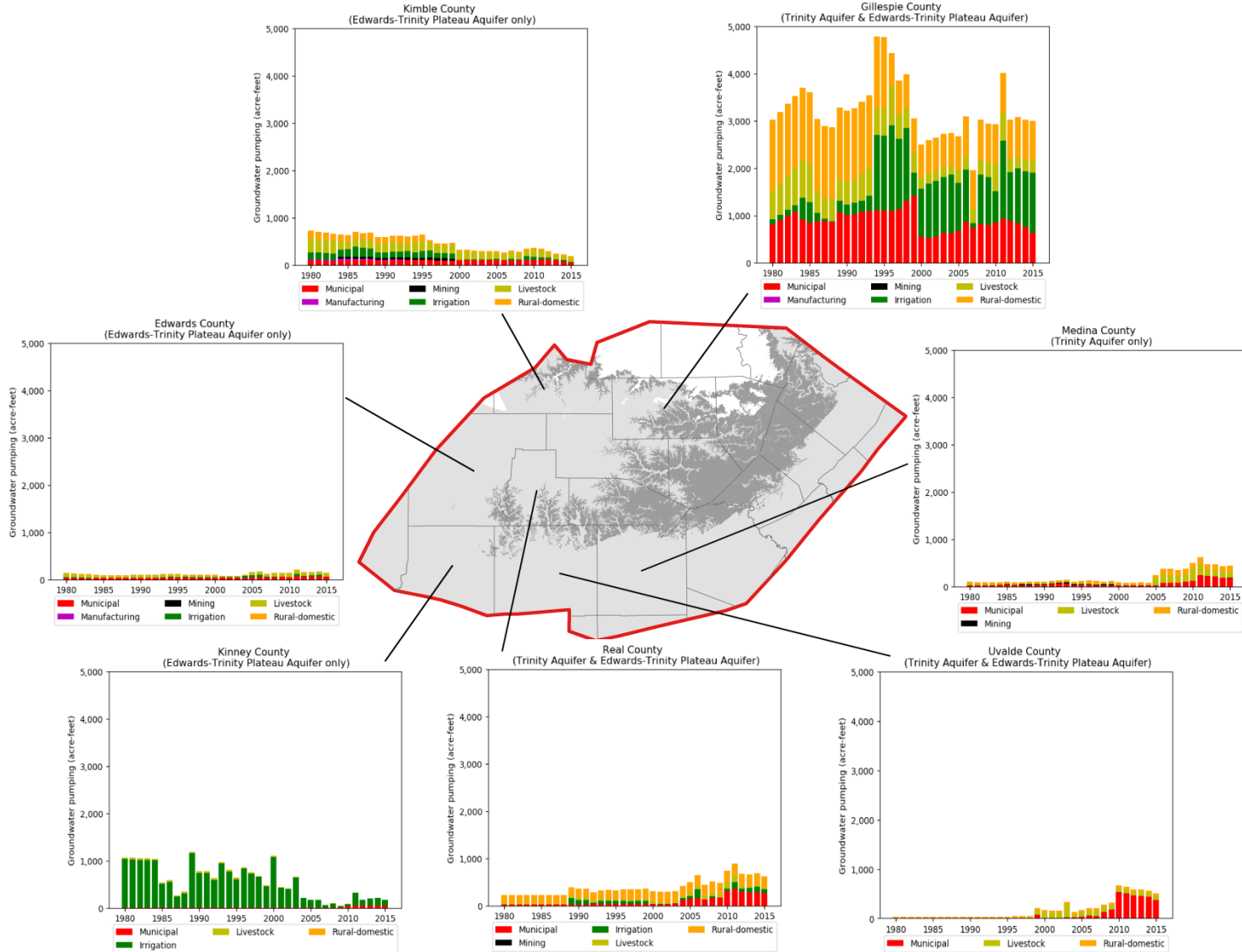

Figure 4.6.7 Estimated total pumping by hydrostratigraphic unit in the eastern/east-central counties of the study area.

Conceptual Model Report for the Hill Country Trinity Aquifer Groundwater Availability Model



Document Path: S:\AUS\TWDB_Trinity_Hill_Country\GIS\mxd\Fig_4_6_x_County_PumpingGraphs_WUG_W.mxd

Figure 4.6.8 Estimated total pumping by water-use category in the western/west-central counties of the study area.

Conceptual Model Report for the Hill Country Trinity Aquifer Groundwater Availability Model

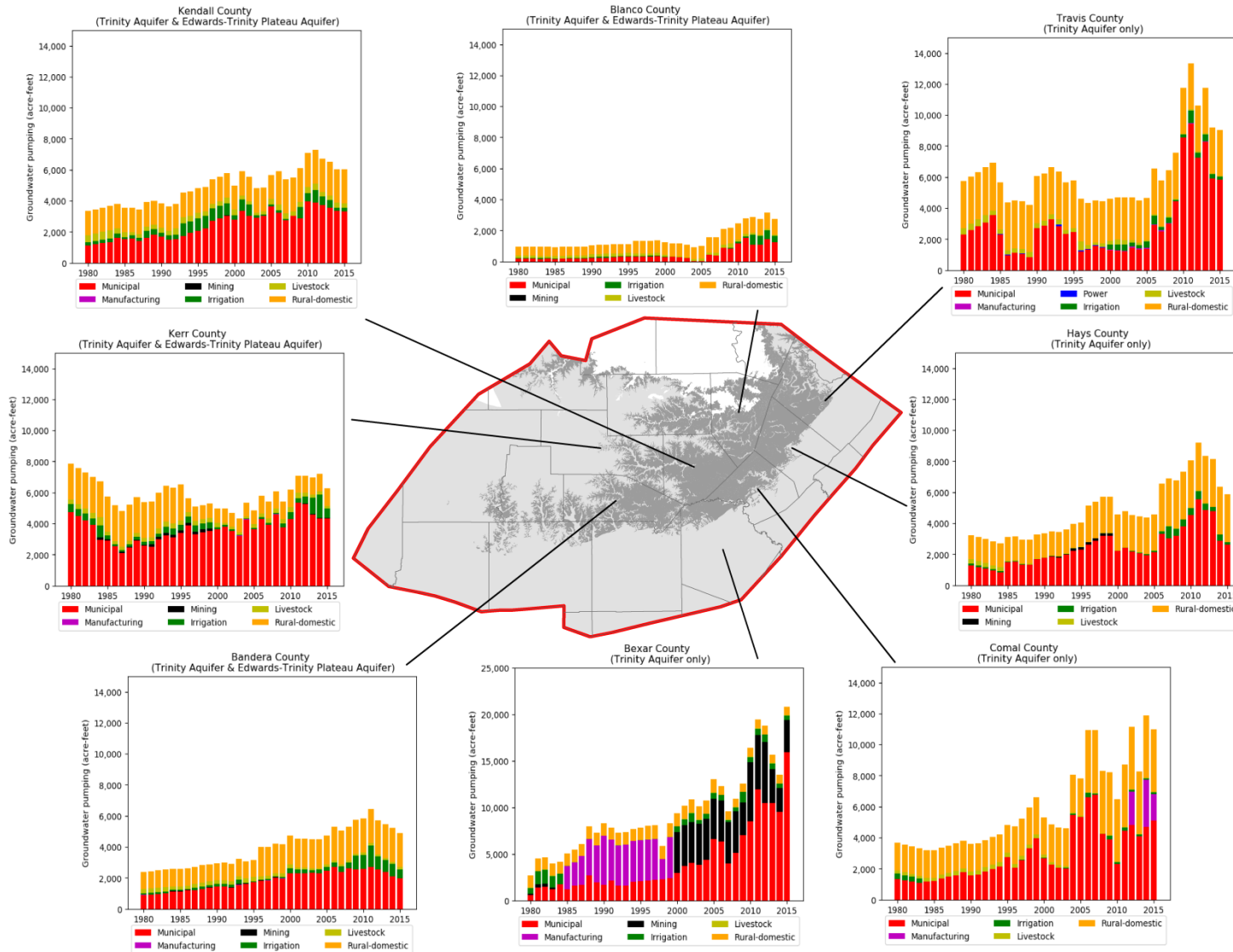
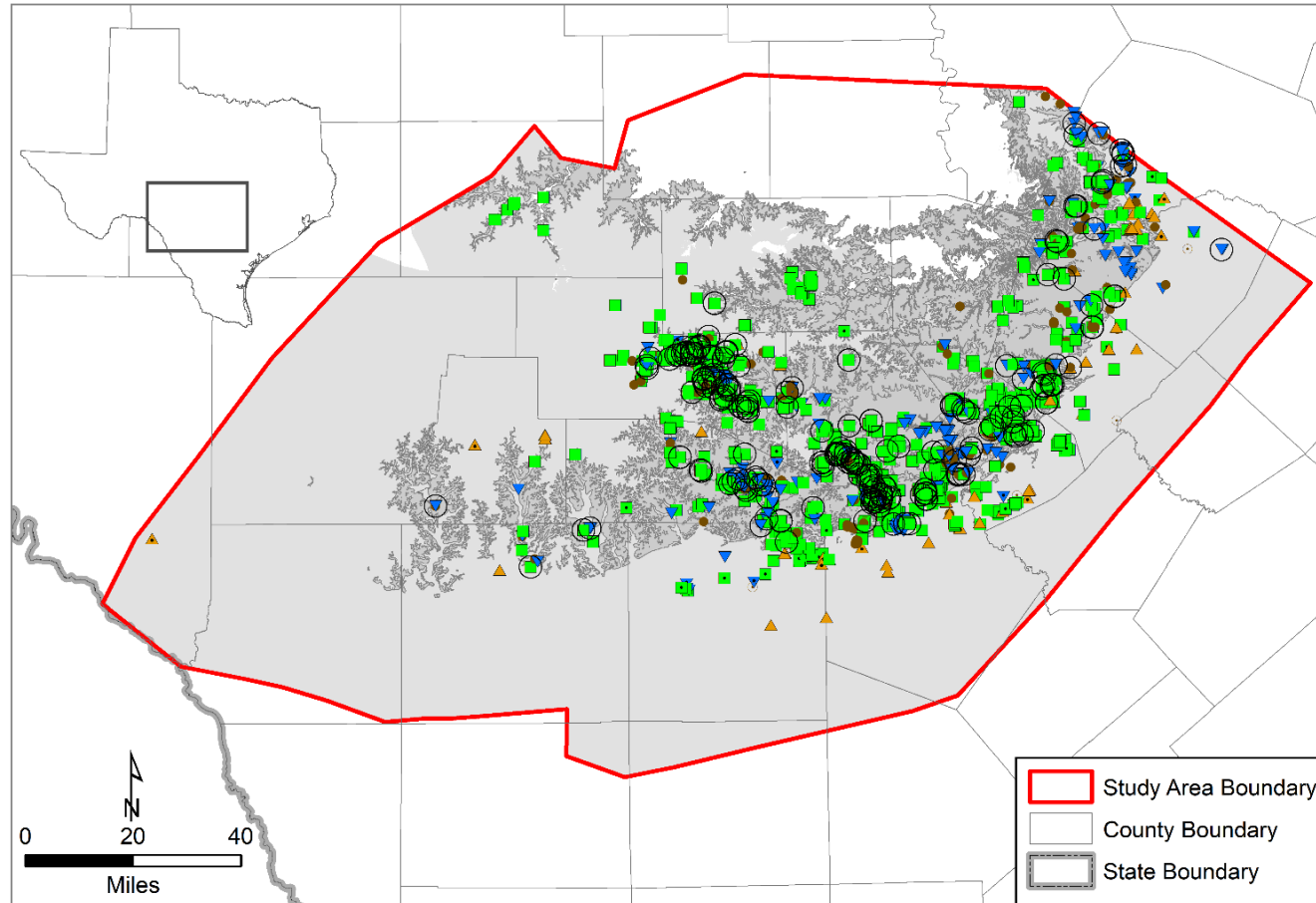

Figure 4.6.9 Estimated total pumping by water-use category in the eastern/east-central counties of the study area.

Conceptual Model Report for the Hill Country Trinity Aquifer
Groundwater Availability Model



Location of Municipal and Industrial Wells (by hydrostratigraphic unit)

Municipal/Public Water Supply Well

▲ Upper Trinity ▼ Lower Trinity

■ Middle Trinity ● mixed Trinity

○ has TWDB pumping record

Industrial Water Supply Well

▲ Upper Trinity ▼ Lower Trinity

■ Middle Trinity ● mixed Trinity

■ Outcrop of all Trinity hydrostratigraphic units

■ Extent of all Trinity hydrostratigraphic units

Figure 4.6.10 Locations of municipal and industrial wells in the study area by hydrostratigraphic unit

Conceptual Model Report for the Hill Country Trinity Aquifer
Groundwater Availability Model

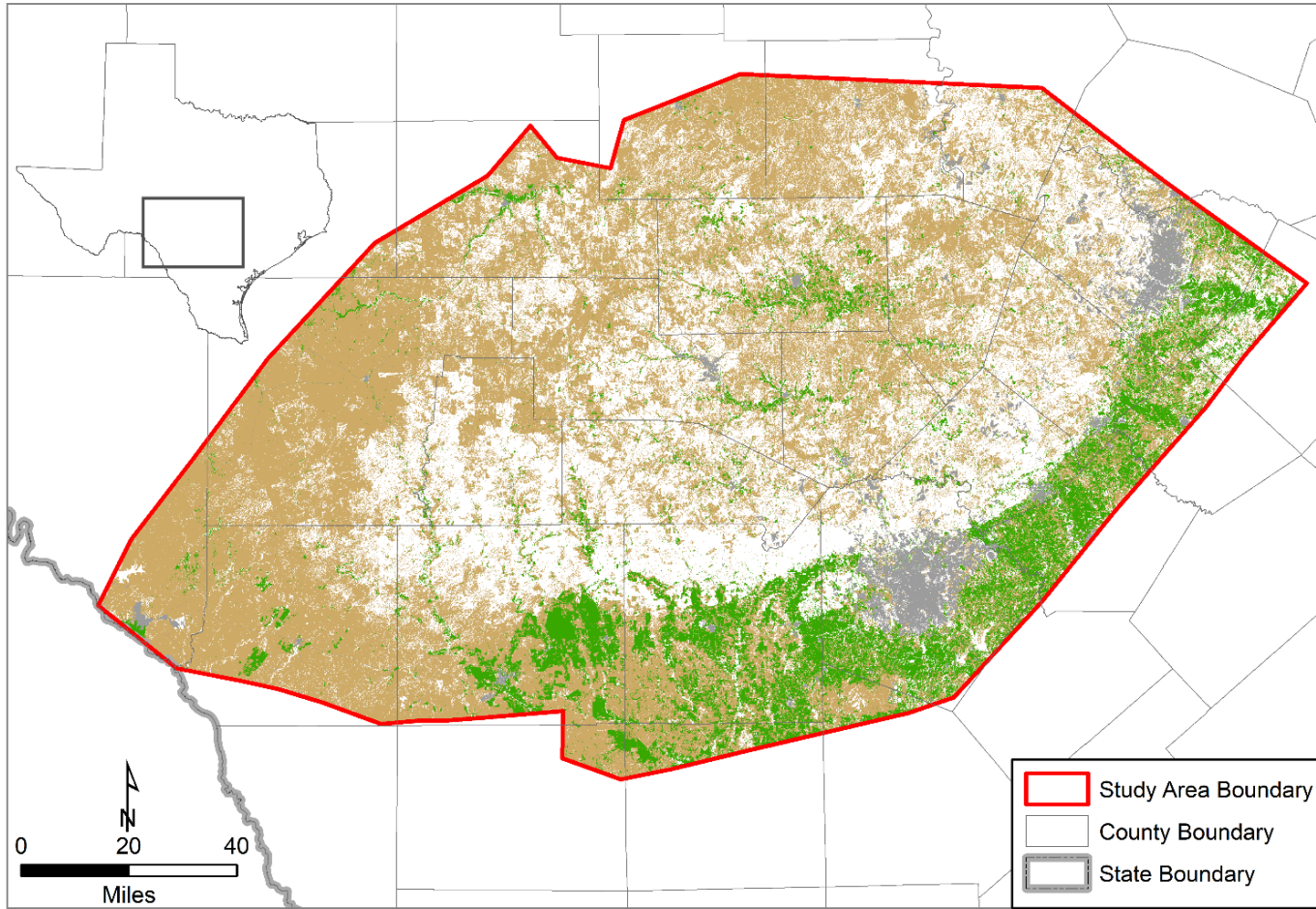

Distribution of Irrigated Land and Rangeland [National Land Cover Dataset (NLCD), 1992]

- Urban (NLCD categories: Residential Land, Commercial/Industrial/Transportation)
- Rangeland (NLCD categories: Shrubland, Grassland/Herbaceous)
- Irrigated Land (NLCD categories: Orchards/Vineyards, Pasture/Hay, Row Crops, Small Grains, Fallow)

Figure 4.6.11 Estimated distribution of irrigated land and rangeland based on Vogelmann and others (2001).

Conceptual Model Report for the Hill Country Trinity Aquifer
Groundwater Availability Model

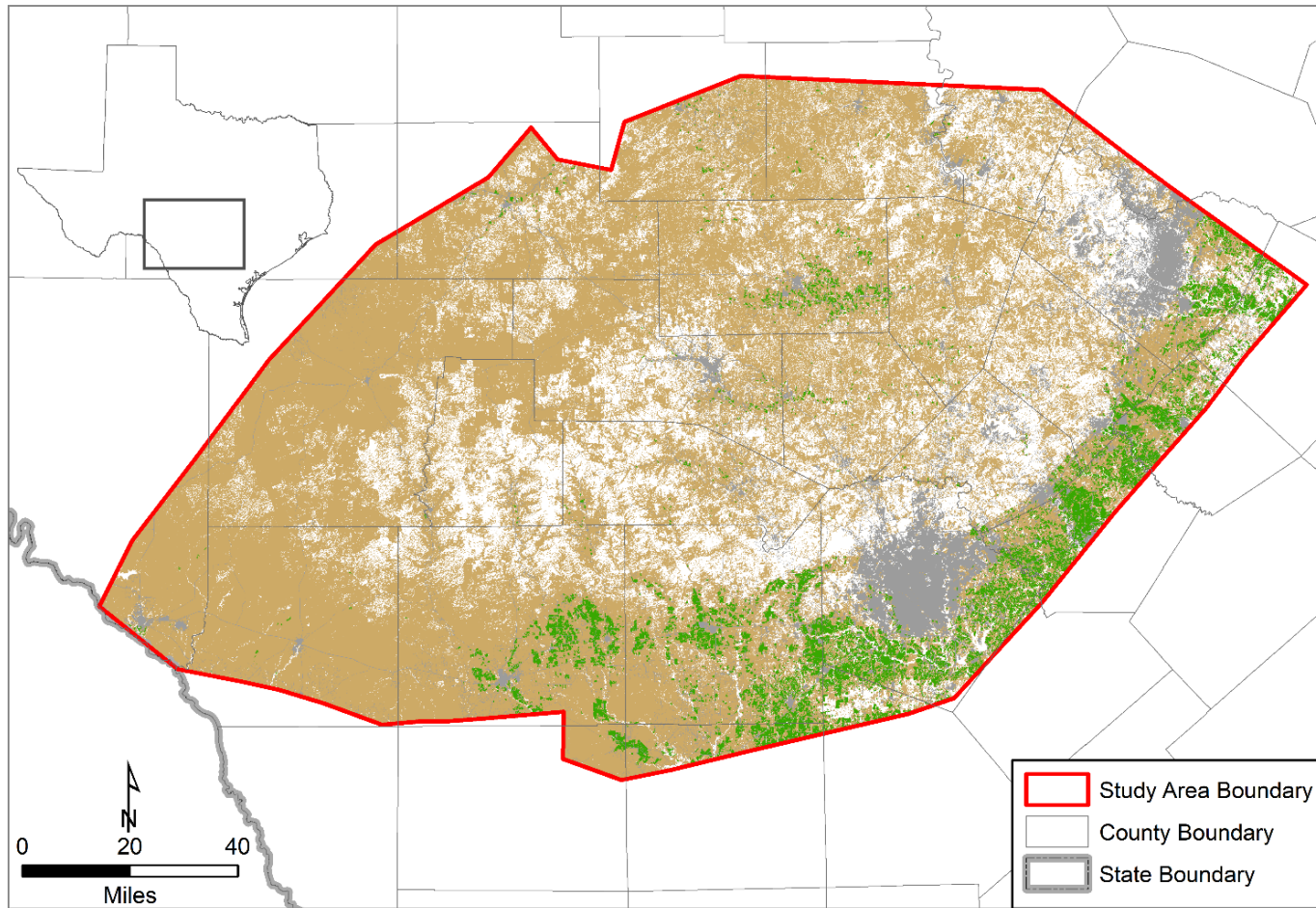

Distribution of Irrigated Land and Rangeland [National Land Cover Dataset (NLCD), 2001]

- Rangeland (NLCD categories: Shrubland, Herbaceous)
- Irrigated Land (NLCD categories: Pasture/Hay, Cultivated Crops)
- Urban (NLCD categories: Developed Land)

Figure 4.6.12 Estimated distribution of irrigated land and rangeland based on Homer and others (2007).

Conceptual Model Report for the Hill Country Trinity Aquifer
Groundwater Availability Model

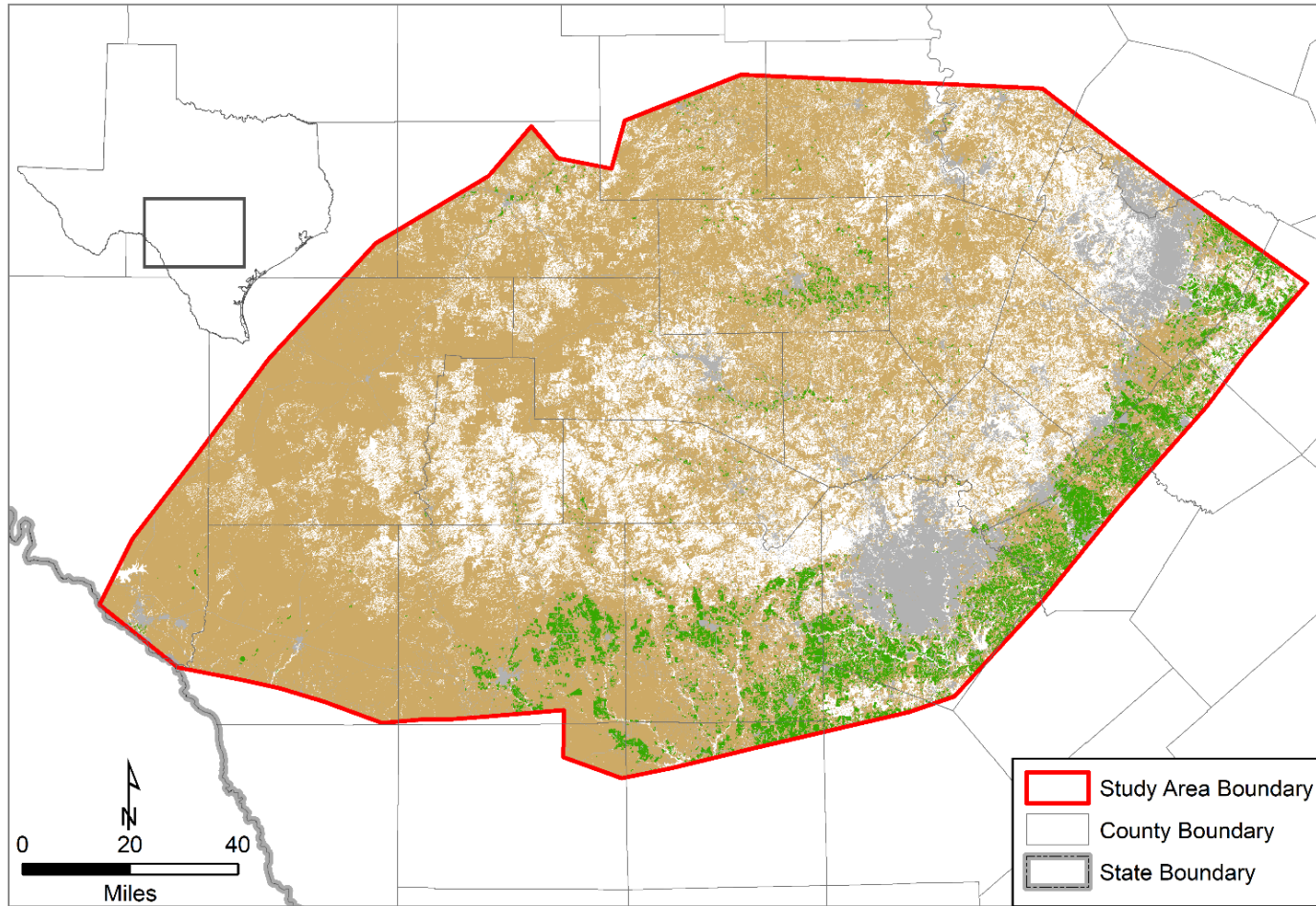

Distribution of Irrigated Land and Rangeland [National Land Cover Dataset (NLCD), 2011]

- Rangeland (NLCD categories: Shrubland, Herbaceous)
- Irrigated Land (NLCD categories: Pasture/Hay, Cultivated Crops)
- Urban (NLCD categories: Developed Land)

Figure 4.6.13 Estimated distribution of irrigated land and rangeland based on Homer and others (2015).

Conceptual Model Report for the Hill Country Trinity Aquifer
Groundwater Availability Model

This page is intentionally blank.

4.7 Water Quality

This section describes the spatial and temporal trends of groundwater quality in the Trinity and Edwards-Trinity (Plateau) aquifers within the HTC Aquifer model area. Water-quality data were extracted from the TWDB database (TWDB, 2018a,b) and National Water Quality Monitoring Council database (NWQMC, 2017). The work builds on the analysis of spatial groundwater-quality trends described by Jones and others (2011). Because the study area for the revised conceptual model includes areas west and south of those considered in Jones and others (2011), the geochemical interpretations have been updated to include the expanded conceptual model study area.

4.7.1 General Water Quality

The description of water quality is based on water-chemistry characteristics for the following hydrostratigraphic units: Upper, Middle, and Lower Trinity Aquifer, Edwards-Trinity in the plateau region, and the Edwards and Trinity aquifers in the Balcones Fault Zone. The distributions of total dissolved solids (TDS) in the Trinity and Edwards-Trinity aquifers and the Upper, Middle, and Lower Trinity aquifers are shown in Figure 4.7.1 through Figure 4.7.4, respectively. The TDS content of water in these hydrostratigraphic units is generally less than 500 milligrams per liter in updip and western portions of the revised model area of the Trinity and Edwards-Trinity aquifers (Figure 4.7.1), but increases downdip to the south and east.

Figure 4.7.5 is a cumulative distribution plot of TDS by hydrostratigraphic unit. The median (50 percentile) TDS in the Upper and Middle Trinity, Edwards-Trinity (Plateau) region, and Edwards and Trinity aquifers in the Balcones Fault Zone is in the range of 200 -250 to 500 milligrams per liter. The TDS of water in the Lower Trinity is significantly more saline with TDS exceeding 1,000 milligrams per liter in Comal, Blanco, Hays, and Travis counties. Water in the Edwards-Trinity Balcones area has a wide range of TDS with significantly higher TDS in the downdip areas where water may mix with saline water in the Edwards Aquifer (Figure 4.7.1).

Figure 4.7.6 shows a Piper diagram of the major ion composition of water in the Trinity Aquifer and Edwards-Trinity in the plateau region. Water composition ranges in type from calcium-carbonate to calcium-magnesium carbonate in the updip and shallower portions of the Trinity Aquifer and in the Edwards-Trinity (Plateau), to calcium-magnesium sulfate and sodium chloride and sodium-carbonate in downdip areas with the highest TDS. This relationship in the Trinity Aquifer is illustrated in Figure 4.7.7 which shows the increasing sulfate and chloride concentrations in the Trinity Aquifer versus TDS. The sulfate concentration increases at nearly the rate as the TDS. The chloride concentration also generally increases with TDS although the trend is less consistent than that of sulfate. These trends are consistent with dissolution of dolostone and gypsum in the Glen Rose Limestone as well as mixing with sodium chloride brine in the deeper portions of the Trinity Aquifer, as noted by Jones and others (2011). With one exception, a similar trend in increase sulfate and chloride with depth is not seen in the Edwards-Trinity (Plateau) Aquifer area, as illustrated in Figure 4.7.8. The only exception is for the well with a depth of 753 feet with sulfate concentrations ranging from 1,300 to 1,600 milligrams per liter. The chloride concentration in this well was relatively low suggesting that the water is locally affected by gypsum-bearing rocks. The well in the Edwards-Trinity (Plateau) Aquifer region with the highest chloride concentration was only 74 feet deep and is probably affected by

a local surface source of salty water. Note, however, that the interpretations of water quality trends in the Edward-Trinity (Plateau) Aquifer area is limited by the range of depths of the wells and their hydrostratigraphic unit classifications in the water quality data base. Thus, trends cannot be reliably extrapolated to deeper portions of the Edward-Trinity (Plateau) Aquifer region.

4.7.2 Water Quality Trends

Trends in water quality were evaluated based on review of water-quality data from the TWDB for wells with multiple data extending over at least 10 years. Figure 4.7.9 shows time histories of TDS for selected wells described as being completed in the Trinity Aquifer, Edwards-Trinity (Plateau) region, and Edwards (Balcones Fault Zone) Aquifer region. No significant trends were identified based on the available data. Given the increase in TDS with depth in the Trinity Aquifer and increasing water production from the Trinity Aquifer, TDS concentrations could increase in the future in areas of heavy groundwater use.

4.7.3 Contribution of Trinity Aquifer to the Edwards (Balcones Fault Zone) Aquifer Based on Water Chemistry

Upward leakage from the Trinity Aquifer into the Edwards (Balcones Fault Zone) Aquifer has been suggested as a potential source of elevated TDS in the Edwards (Balcones Fault Zone) Aquifer. Clark and Journey (2006) distinguished Trinity Aquifer water from Edwards (Balcones Fault Zone) Aquifer water along flow paths in Medina and Uvalde counties on the basis of Trinity Aquifer water being more mineralized than Edwards (Balcones Fault Zone) Aquifer water in these areas. Musgrove and others (2010) conducted an analysis of groundwater-quality characteristics of the Edwards (Balcones Fault Zone) Aquifer and portions of the Trinity Aquifer in the San Antonio Segment of the Edwards (Balcones Fault Zone) Aquifer based on National Water-Quality Assessment Program (NAWQA) data from 1996 to 2006. They tentatively identified mixing of Trinity Aquifer water (as opposed to Edwards (Balcones Fault Zone) Aquifer Saline zone water) with Edwards (Balcones Fault Zone) Aquifer water on the basis of increasing magnesium-to-sodium and sulfate-to-chloride ratios, with these ratios increasing with increased contribution from the Trinity Aquifer. If correct, the Musgrove and others (2010) interpretation would imply that the greatest contributions of Trinity Aquifer water to the Edwards (Balcones Fault Zone) Aquifer occur within the unconfined portion of the Edwards (Balcones Fault Zone) Aquifer within the San Antonio Segment (Figure 4.7.10). This finding may be attributed to the more intense faulting and vertical conduit development between the Trinity and Edwards (Balcones Fault Zone) Aquifer strata in the unconfined portion relative to the confined portion of the Edwards (Balcones Fault Zone) Aquifer. This interpretation is consistent with the general water-quality trend described in the preceding section that the TDS and salinity of the Trinity Aquifer water increase downdip and the finding by Clark and Journey (2006) that Trinity Aquifer water is more mineralized than Edwards (Balcones Fault Zone) Aquifer water in the Balcones Fault Zone.

Conceptual Model Report for the Hill Country Trinity Aquifer
Groundwater Availability Model

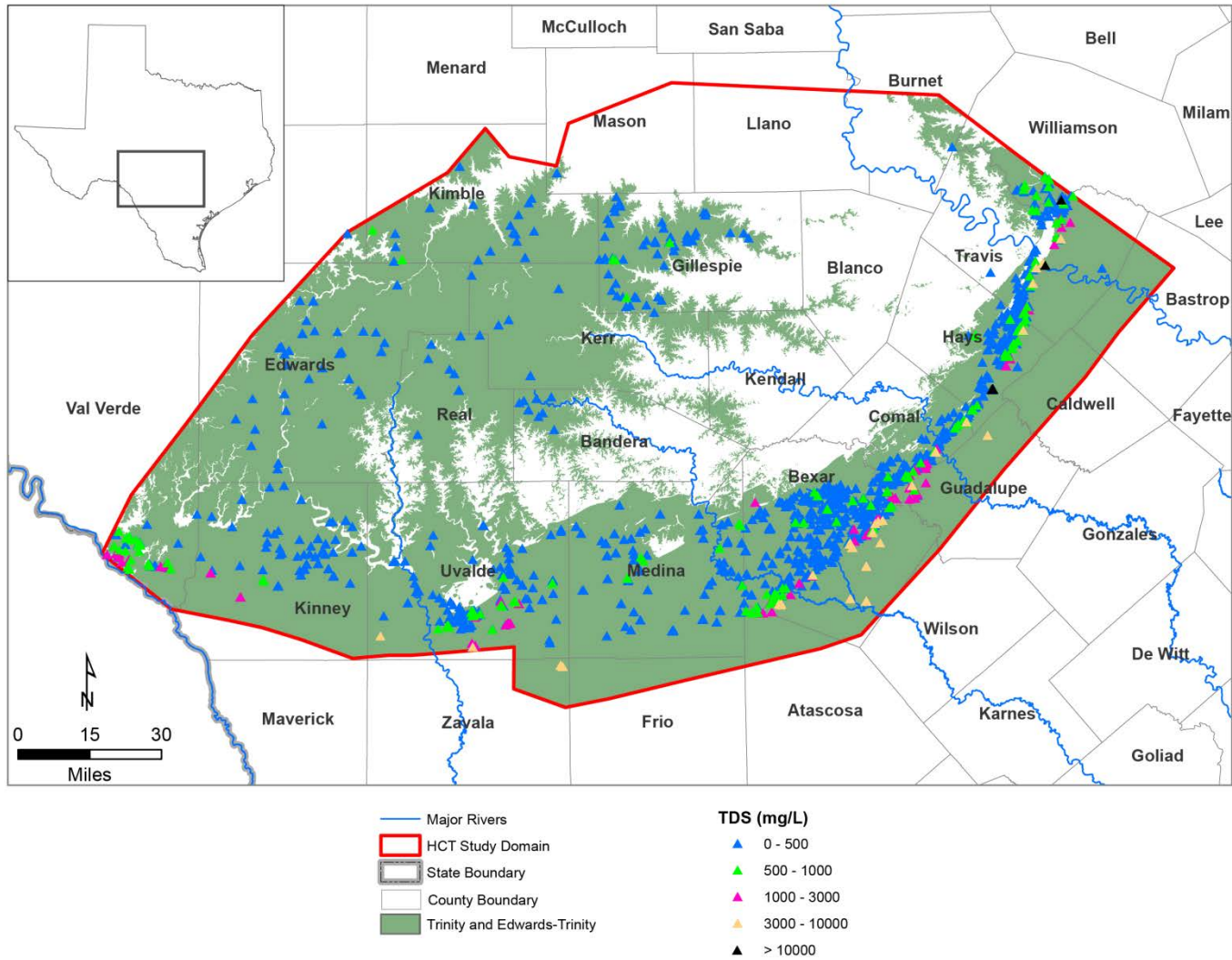

Figure 4.7.1 Total Dissolved Solids (TDS) in the Trinity Aquifer and Edwards-Trinity Aquifer within the revised Hill Country GAM study area.

Conceptual Model Report for the Hill Country Trinity Aquifer
Groundwater Availability Model

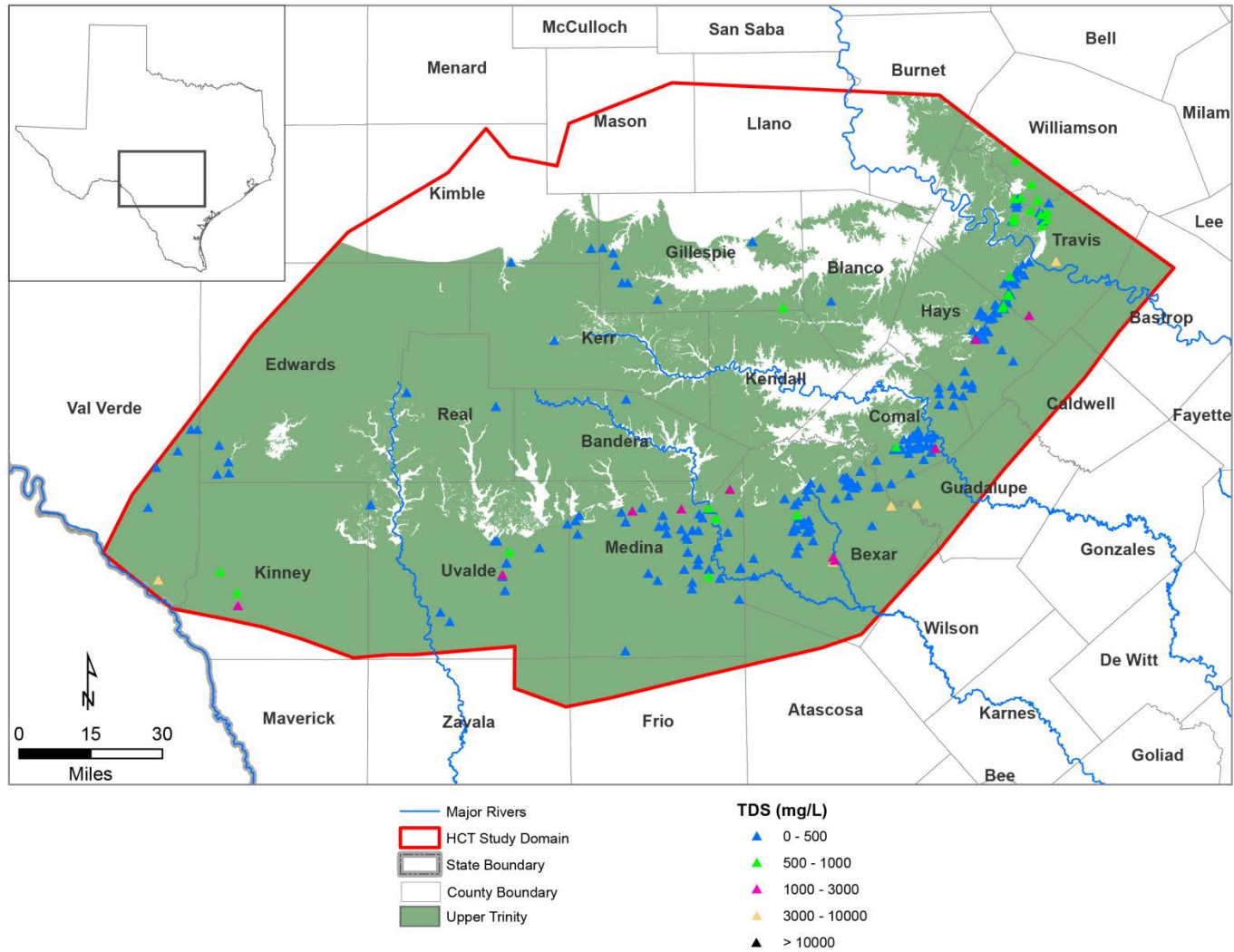

Figure 4.7.2 Total Dissolved Solids (TDS) in the Upper Trinity within the revised Hill Country GAM study area.

Conceptual Model Report for the Hill Country Trinity Aquifer
Groundwater Availability Model

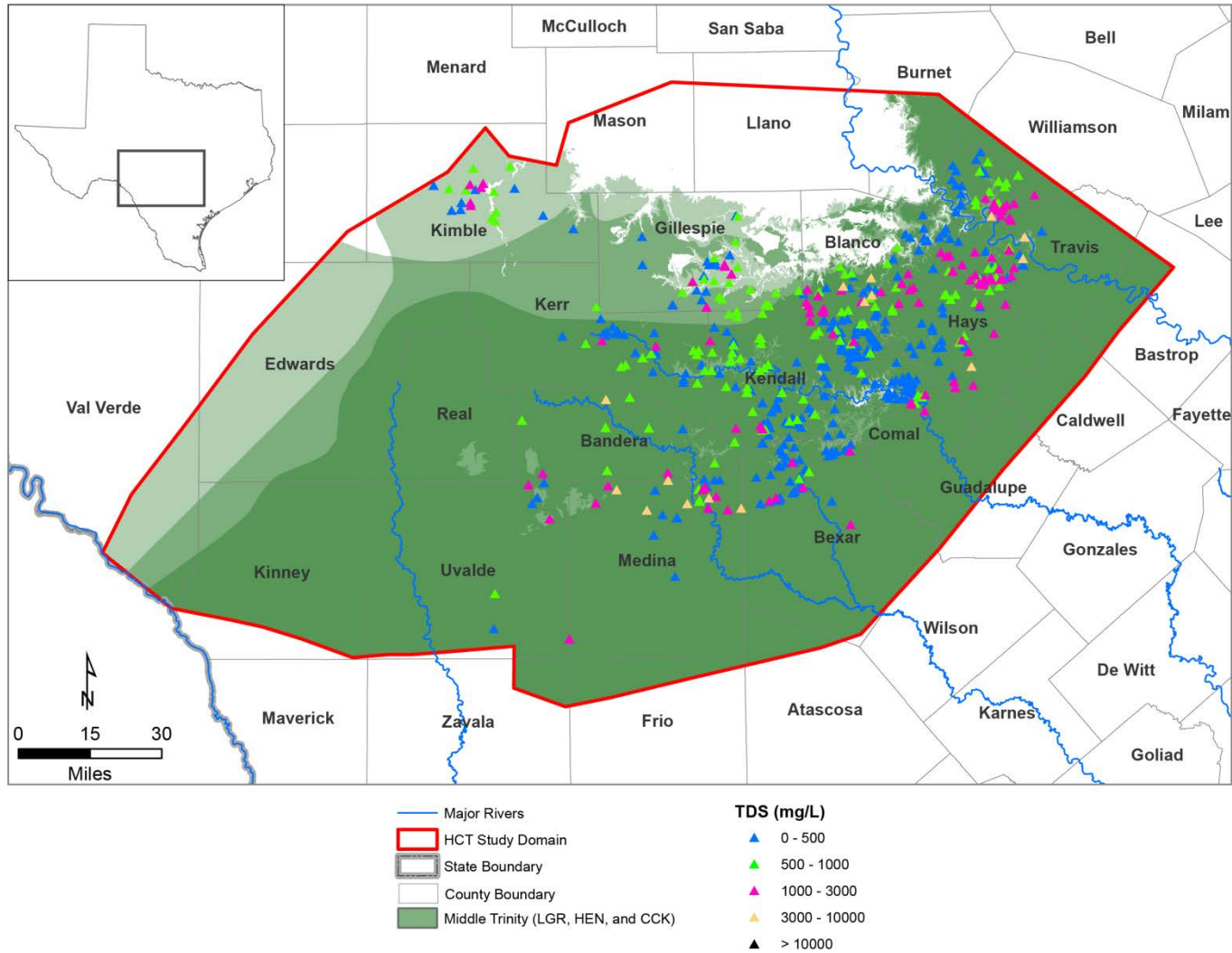

Figure 4.7.3 Total Dissolved Solids (TDS) in the Middle Trinity within the revised Hill Country GAM study area.

Conceptual Model Report for the Hill Country Trinity Aquifer
Groundwater Availability Model

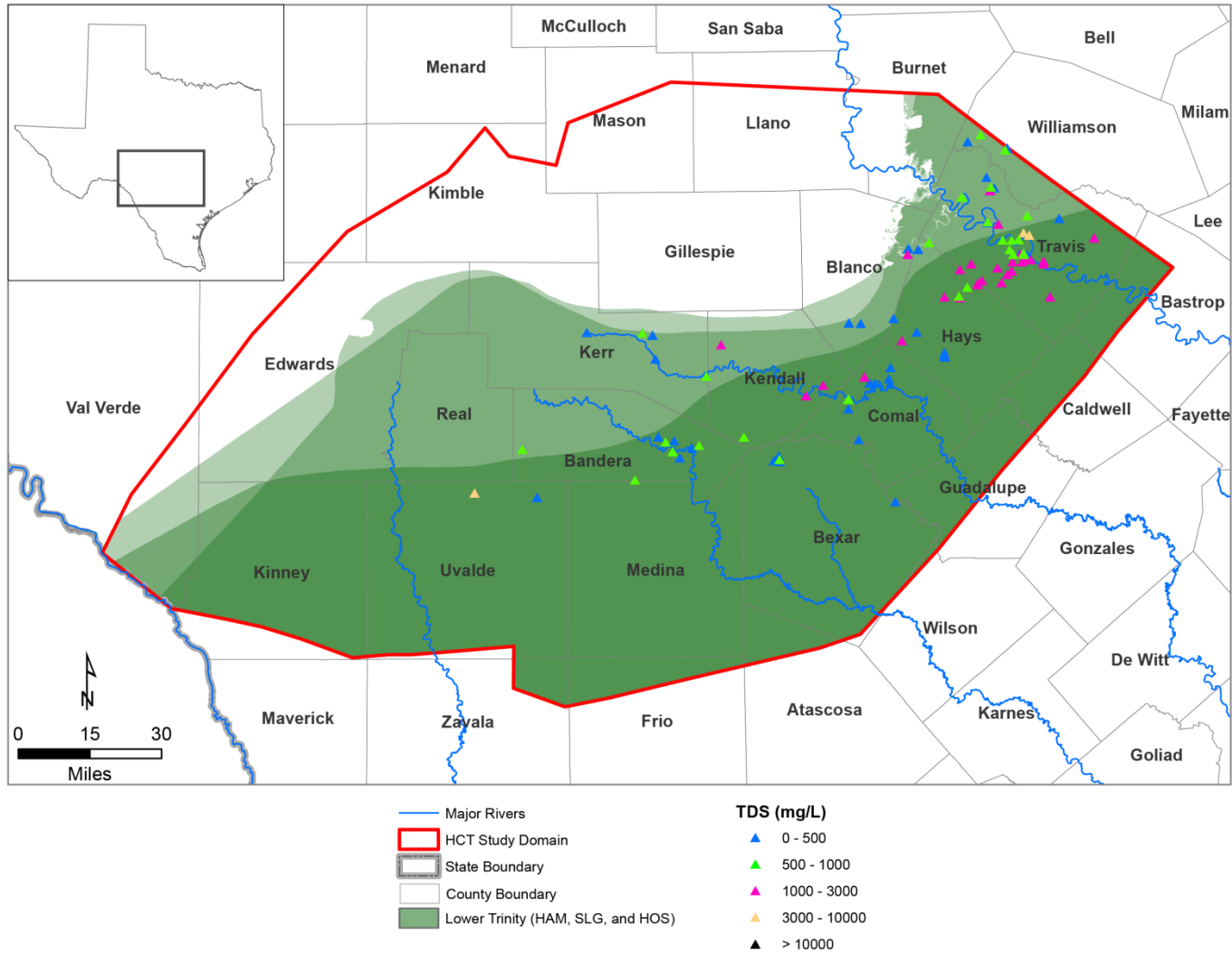

Figure 4.7.4 Total Dissolved Solids (TDS) in the Lower Trinity within the revised Hill Country GAM study area.

Conceptual Model Report for the Hill Country Trinity Aquifer
Groundwater Availability Model

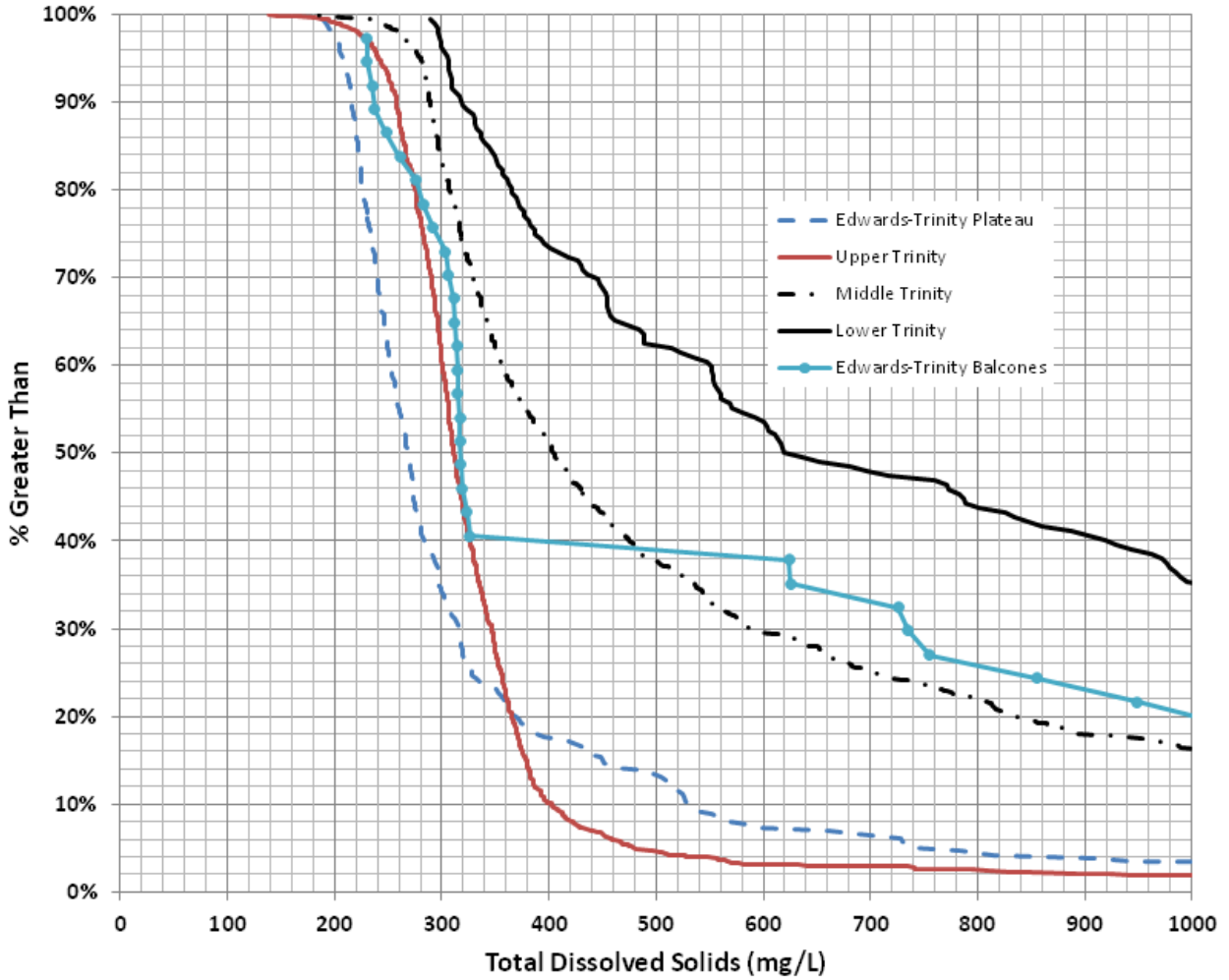

Figure 4.7.5 Cumulative Distribution of Total Dissolved Solids (TDS) in the Upper, Middle, and Lower Trinity Aquifer, Edwards-Trinity (Plateau) Region, and Edwards and Trinity aquifers in the Balcones Fault Zone.

Conceptual Model Report for the Hill Country Trinity Aquifer
Groundwater Availability Model

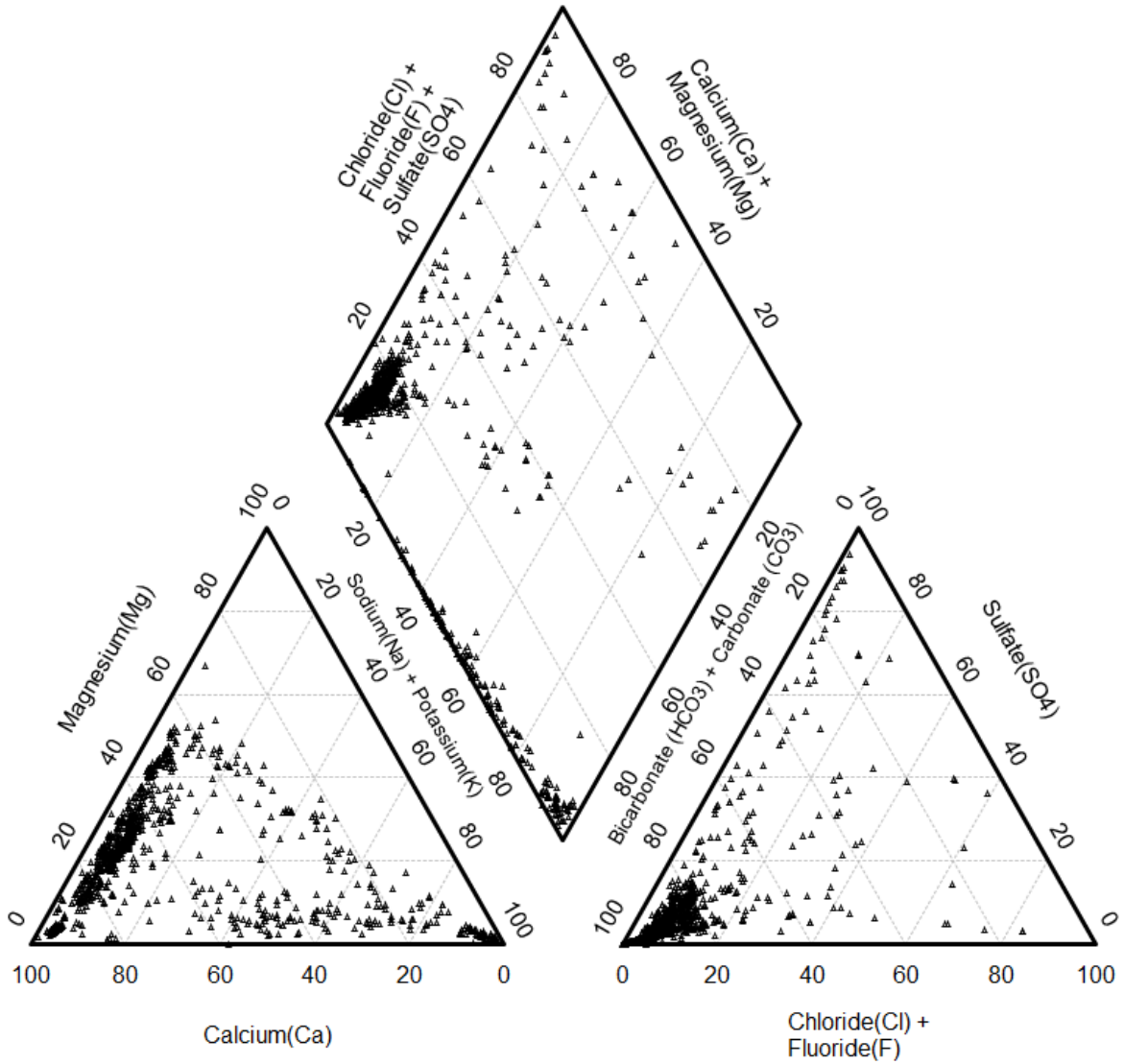

Figure 4.7.6 Piper diagram showcasing the major ion composition of groundwater in the Trinity Aquifer and Edwards-Trinity (Plateau) area.

Conceptual Model Report for the Hill Country Trinity Aquifer
Groundwater Availability Model

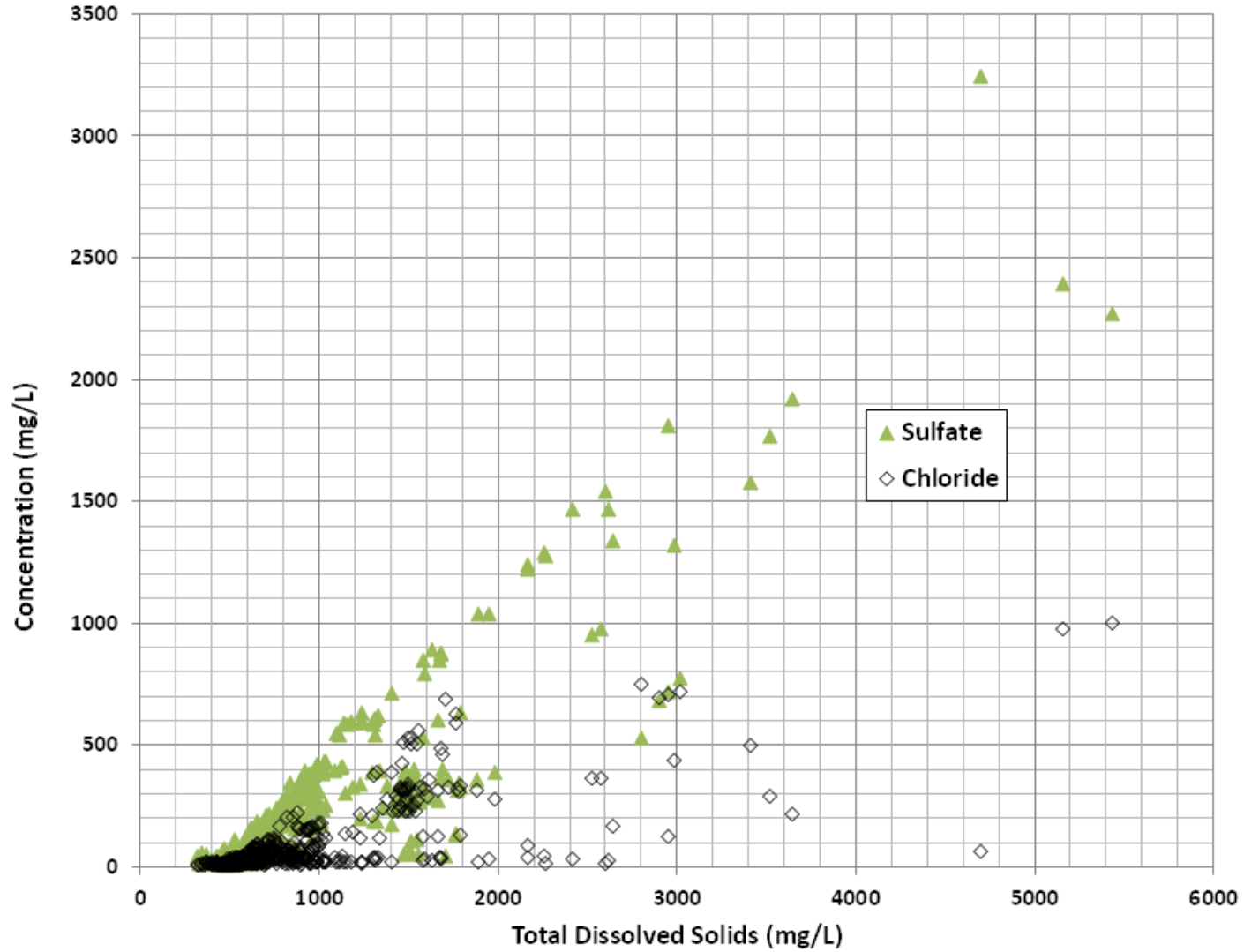
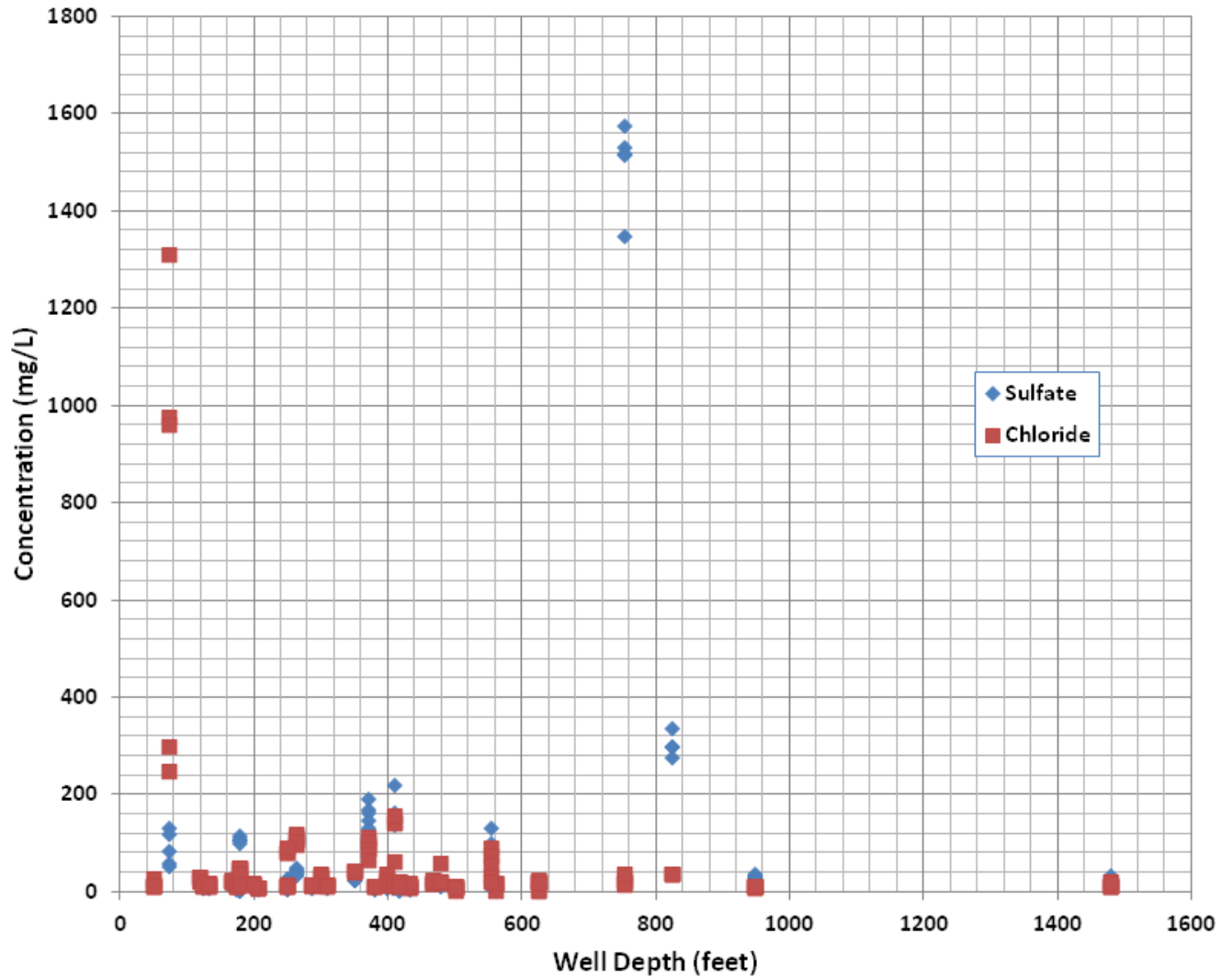

Figure 4.7.7 Sulfate and chloride concentrations versus Total Dissolved Solids (TDS) in the Trinity Aquifer

Conceptual Model Report for the Hill Country Trinity Aquifer
Groundwater Availability Model



Conceptual Model Report for the Hill Country Trinity Aquifer Groundwater Availability Model



Figure 4.7.9 Time histories of Total Dissolved Solids (TDS) in selected wells within the revised Hill Country Model domain completed in the Trinity Aquifer, Edwards-Trinity (Plateau) Region, and Edwards and Trinity aquifers in the Balcones Fault Zone.

Conceptual Model Report for the Hill Country Trinity Aquifer
Groundwater Availability Model

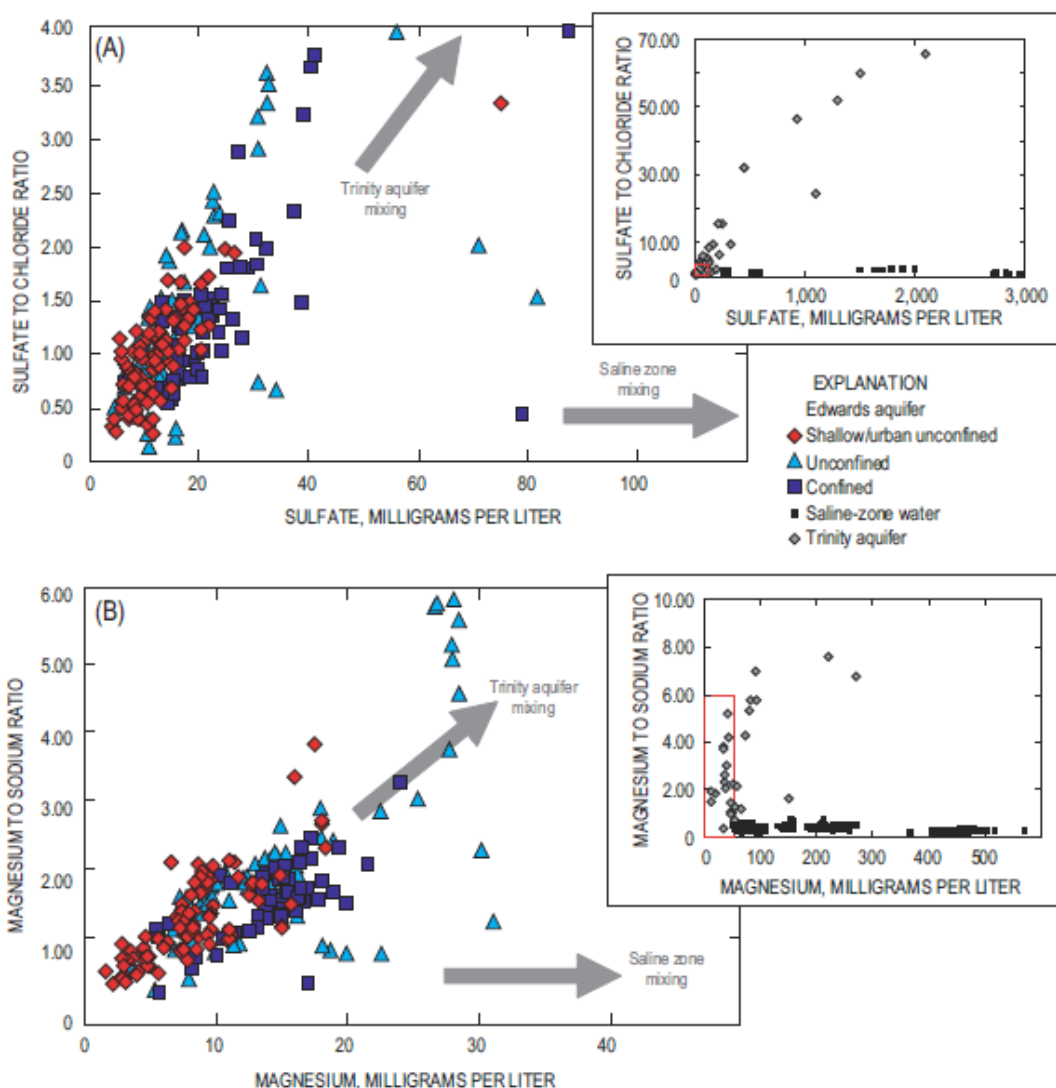

Figure 12. Relation between (A) sulfate to chloride ratio and sulfate concentration, and (B) magnesium to sodium ratio and magnesium concentration for groundwater samples collected from shallow/urban unconfined, unconfined, and confined parts of the San Antonio segment of the Edwards aquifer, south-central Texas, 1996–2006.

Trinity aquifer data from U.S. Geological Survey (2009) and saline-zone groundwater data from San Antonio Water System (Hydrogeologic Studies and Assessment Division, written commun., 2009). Red-bounded boxes in inserts denote scale expanded in (A) and (B). Arrows on (A) and (B) highlight mixing pathways with underlying Trinity aquifer groundwater (median sulfate to chloride ratio = 4.9; sulfate = 130 milligrams per liter (mg/L); magnesium to sodium ratio = 2.2; magnesium = 48 mg/L; n = 31) and downdip saline-zone groundwater in Bexar, Comal, and Hays Counties (median sulfate to chloride ratio = 1.04, n = 376; sulfate = 1,649 mg/L, n = 525; magnesium to sodium ratio = 0.34, n = 395; magnesium = 371 mg/L, n = 371).

Figure 4.7.10 Mixing between the Trinity Aquifer and Edwards (Balcones Fault Zone) Aquifer interpreted based on major ion ratios (taken from Musgrove and others, 2010).

5.0 Conceptual Model of Flow in the Aquifer

The conceptual model of groundwater flow in the HCT Aquifer is based on the hydrogeologic setting described in Section 4. The conceptual model is a simplified representation of the hydrogeological features that govern groundwater flow in the aquifer. It includes the hydrostratigraphy, hydrogeologic framework, hydraulic properties, hydrologic boundaries, recharge, and discharge. Groundwater flow varies significantly with location across the HCT Aquifer. This variability results mostly from its complex geologic structure and changes in formation facies.

5.1 Overview

Conceptual models are developed to provide the best understanding of groundwater flow in the aquifer. When precipitation falls on areas that recharge the aquifer, much of the water either evapotranspires or runs off into local streams and eventually discharges through major streams out of the study area. However, some of the precipitation infiltrates into and recharges the underlying aquifer. Recharge to an aquifer can occur from several sources: (i) when precipitation falls within the confines of the aquifer (autogenic recharge), (ii) when precipitation falls outside of the confines of the aquifer, but then flows onto the aquifer where it provides recharge (allogenic recharge); or (iii) from inter-formational inflow in the subsurface. The HCT Aquifer is recharged by all three of these mechanisms. Allogenic recharge mostly occurs due to the fact that surface watersheds that overly the aquifer do not fully align with groundwater basins (Figure 5.1.1).

The HCT Aquifer extends across four geophysical provinces in central Texas; Edwards (Plateau), Hill Country, Balcones Fault Zone, and Gulf Coast (Wermund, 1996). The names of the formations that comprise the HCT Aquifer vary with geological province (Figure 2.2.1). Formations in the Balcones Fault Zone and the Gulf Coast provinces are similar and include, from older to younger, Hosston Formation, Sligo Formation, Pine Island Shale Member, Cow Creek Limestone Member, Bexar Shale Member, and Glen Rose Limestone. The Hill Country province is similar to the Balcones Fault Zone and the Gulf Coast provinces, but exhibits a facies change from Pine Island Shale Member in the Hill County province to Hammett Shale in the Balcones Fault Zone and Gulf Coast provinces. In addition, the Sycamore Sand in the Edwards (Plateau) province transitions to the Sligo Formation and the Hosston Formation in the other three provinces. As described in Section 4, the Trinity Aquifer thins to the north and west where several units pinch out, including the Glen Rose Limestone, Cow Creek Limestone Member, and Hammett Shale. As illustrated in three vertical cross sections, the Trinity Aquifer is absent where the Llano Uplift is exposed (Figure 5.1.2-5.1.8).

The designated boundaries of the HCT Aquifer in this study were modified from the HCT Aquifer boundaries previously defined by Mace and others (2000) and Jones and others (2011) to allow for more natural hydraulic boundaries to be assigned to both conceptual and numerical models of the aquifer. As described in Chapter 1, the TWDB required that the HCT Aquifer conceptual model include Groundwater Management Area 9. The study area boundaries delineated in Figure 5.1.8 were specified at the onset of project after consultation with staff from

Conceptual Model Report for the Hill Country Trinity Aquifer
Groundwater Availability Model

the TWDB. To the degree possible at that time, the study area contained what was thought to be the hydraulic boundaries of the HCT Aquifer.

Conceptual Model Report for the Hill Country Trinity Aquifer
Groundwater Availability Model

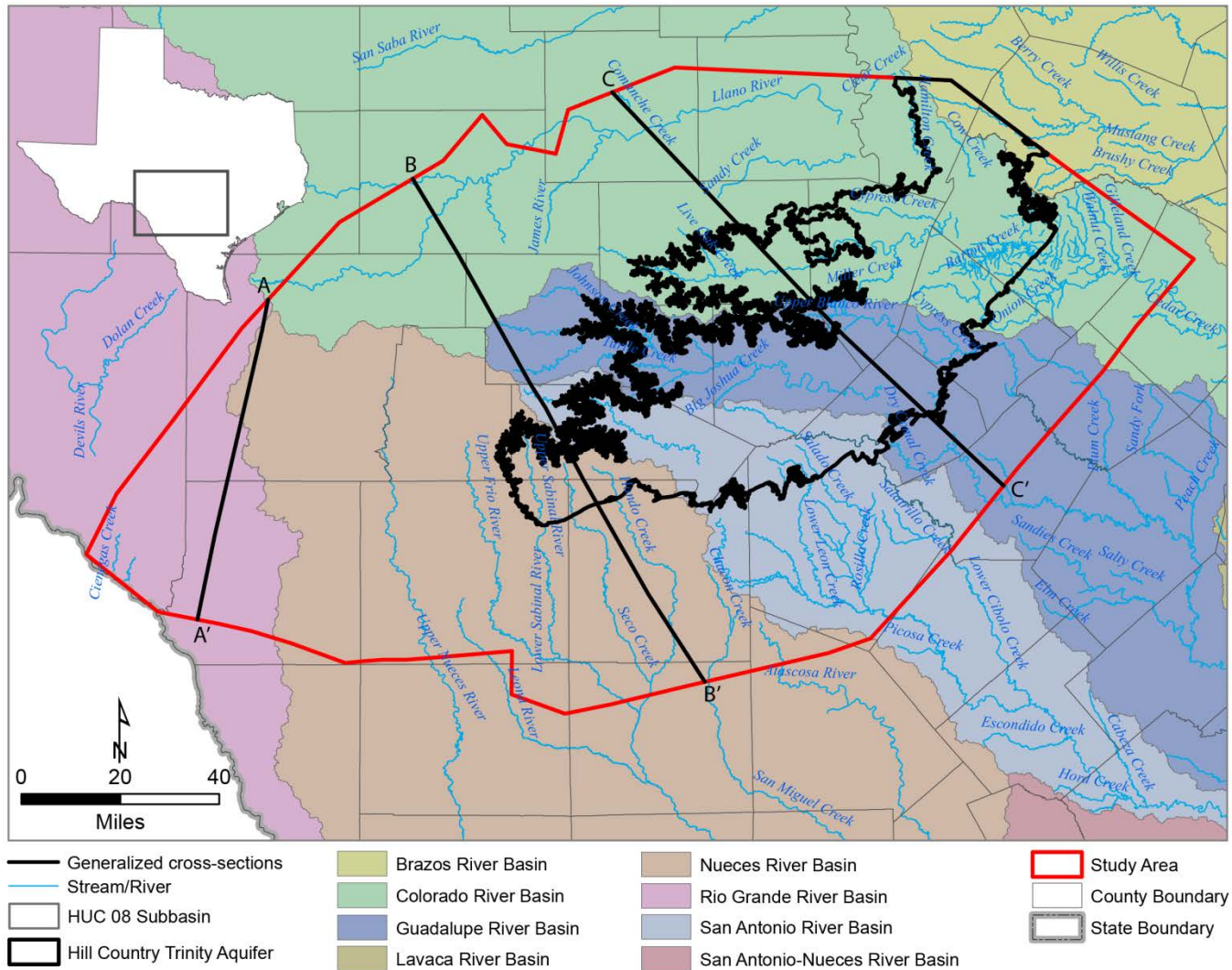

Figure 5.1.1 Map of the study area with major river watersheds. Location of three cross-sections present in Figure 5.1.3, 5.1.5, and 5.1.7 are illustrated.

Conceptual Model Report for the Hill Country Trinity Aquifer
Groundwater Availability Model

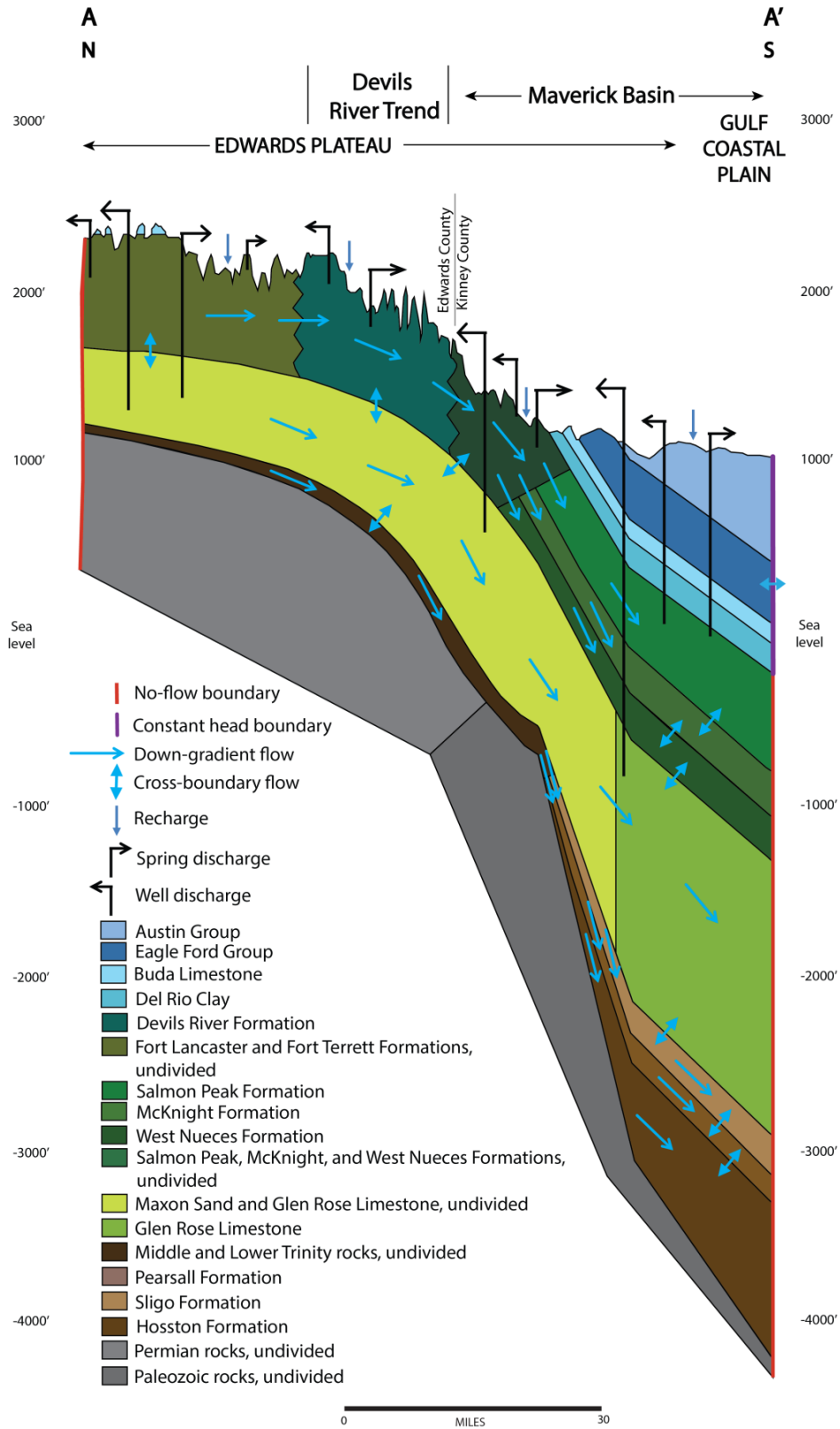

Figure 5.1.2 Hydrostratigraphic vertical cross section A-A' with flow between layers.

Conceptual Model Report for the Hill Country Trinity Aquifer
Groundwater Availability Model

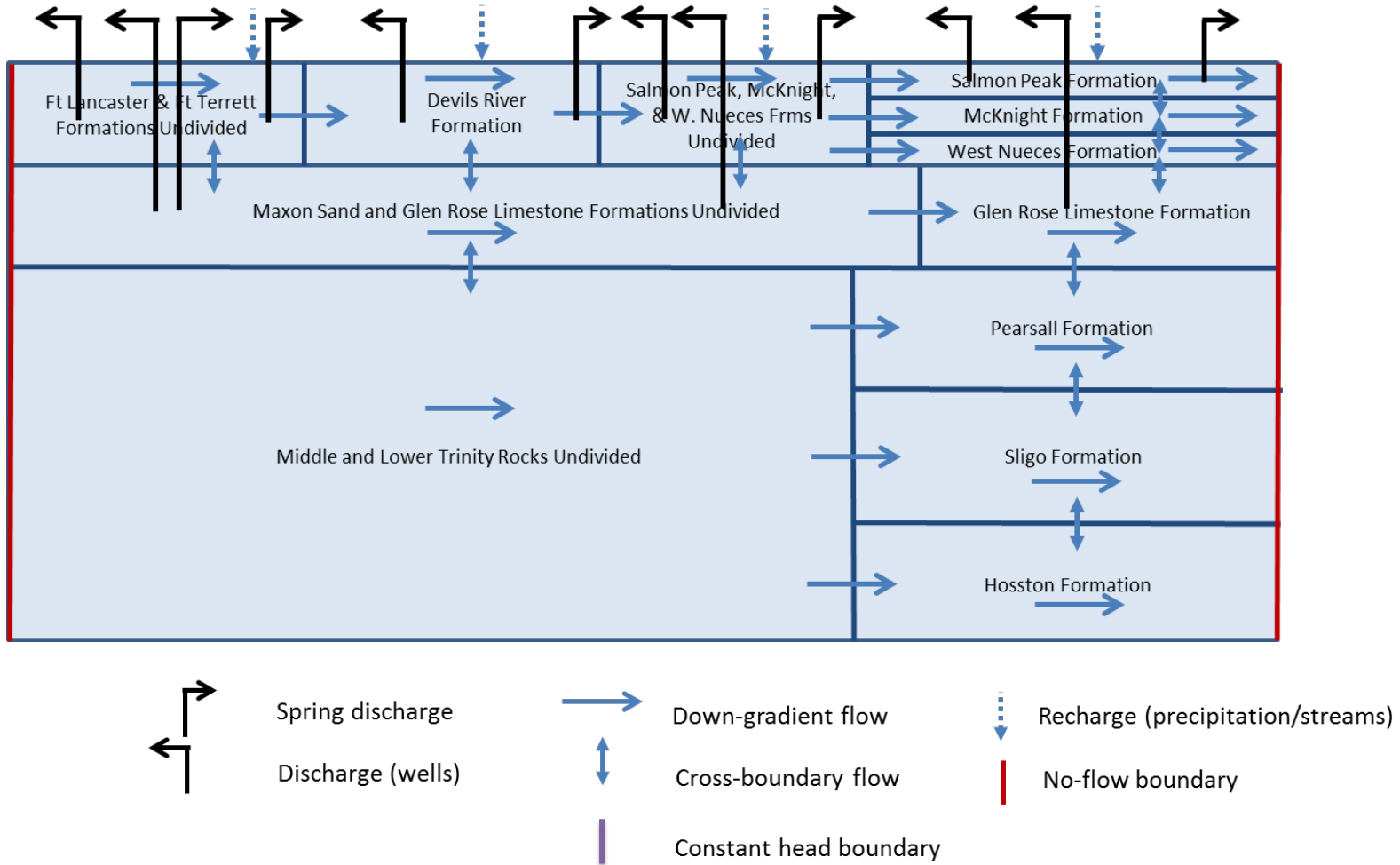

Figure 5.1.3 Block diagram of A-A' transect illustrating how the conceptual model translates to the numerical model.

Conceptual Model Report for the Hill Country Trinity Aquifer Groundwater Availability Model

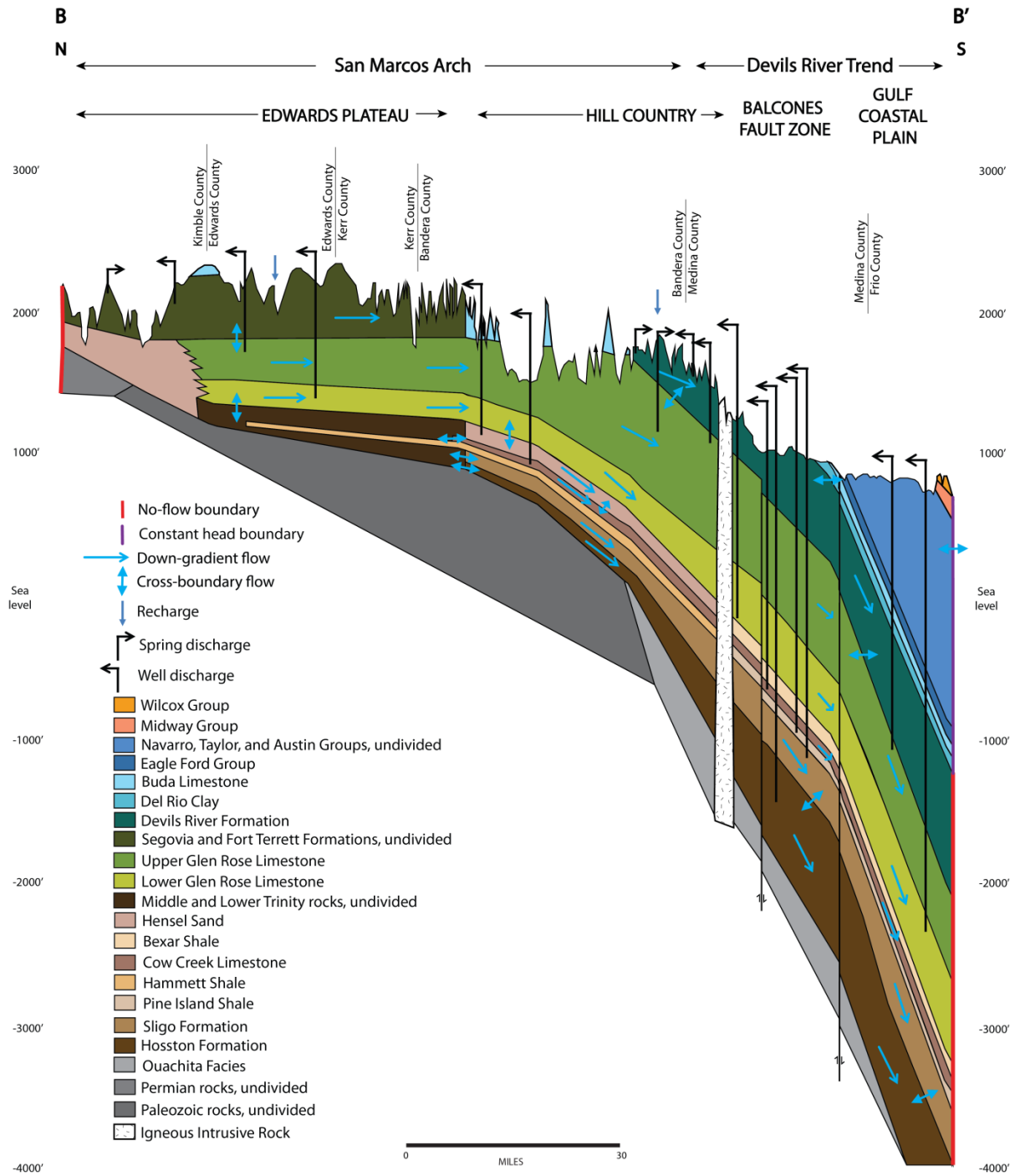

Figure 5.1.4 Hydrostratigraphic vertical cross section B-B' with flow between layers.

Conceptual Model Report for the Hill Country Trinity Aquifer
Groundwater Availability Model

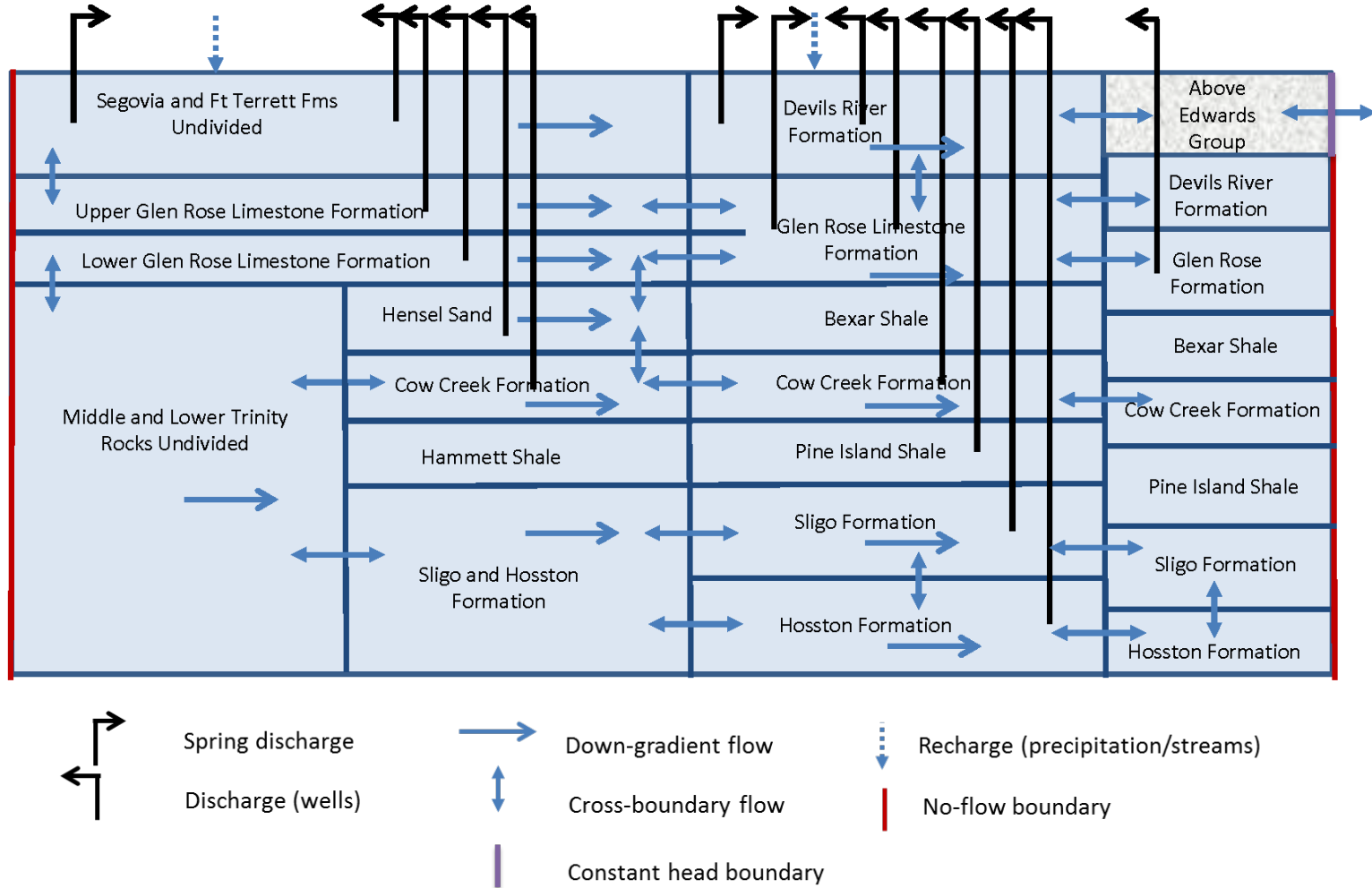

Figure 5.1.5 Block diagram of B-B' transect illustrating how the conceptual model translates to the numerical model.

Conceptual Model Report for the Hill Country Trinity Aquifer
Groundwater Availability Model

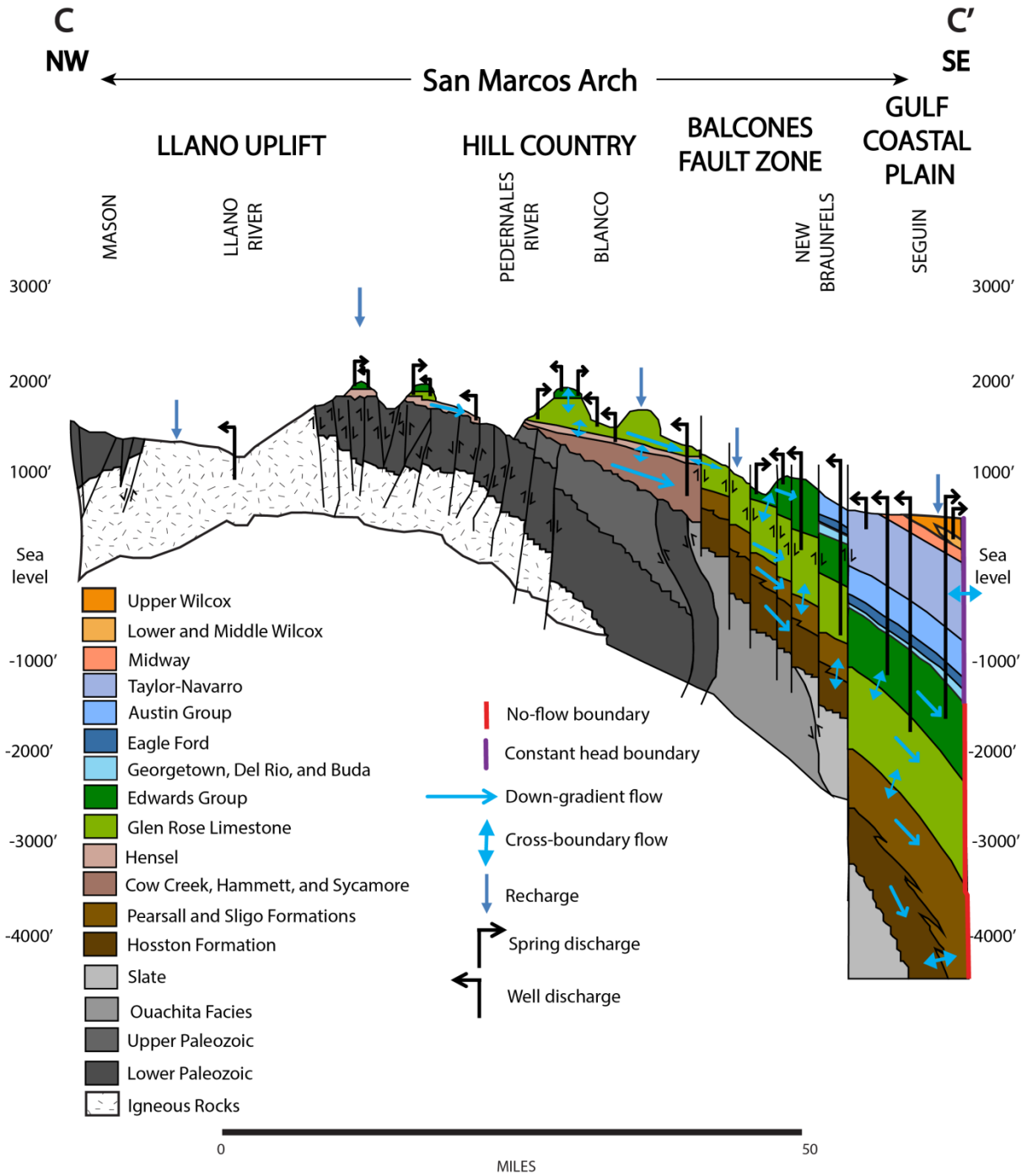

Figure 5.1.6 Hydrostratigraphic vertical cross section C-C' with flow between layers.

Conceptual Model Report for the Hill Country Trinity Aquifer
Groundwater Availability Model

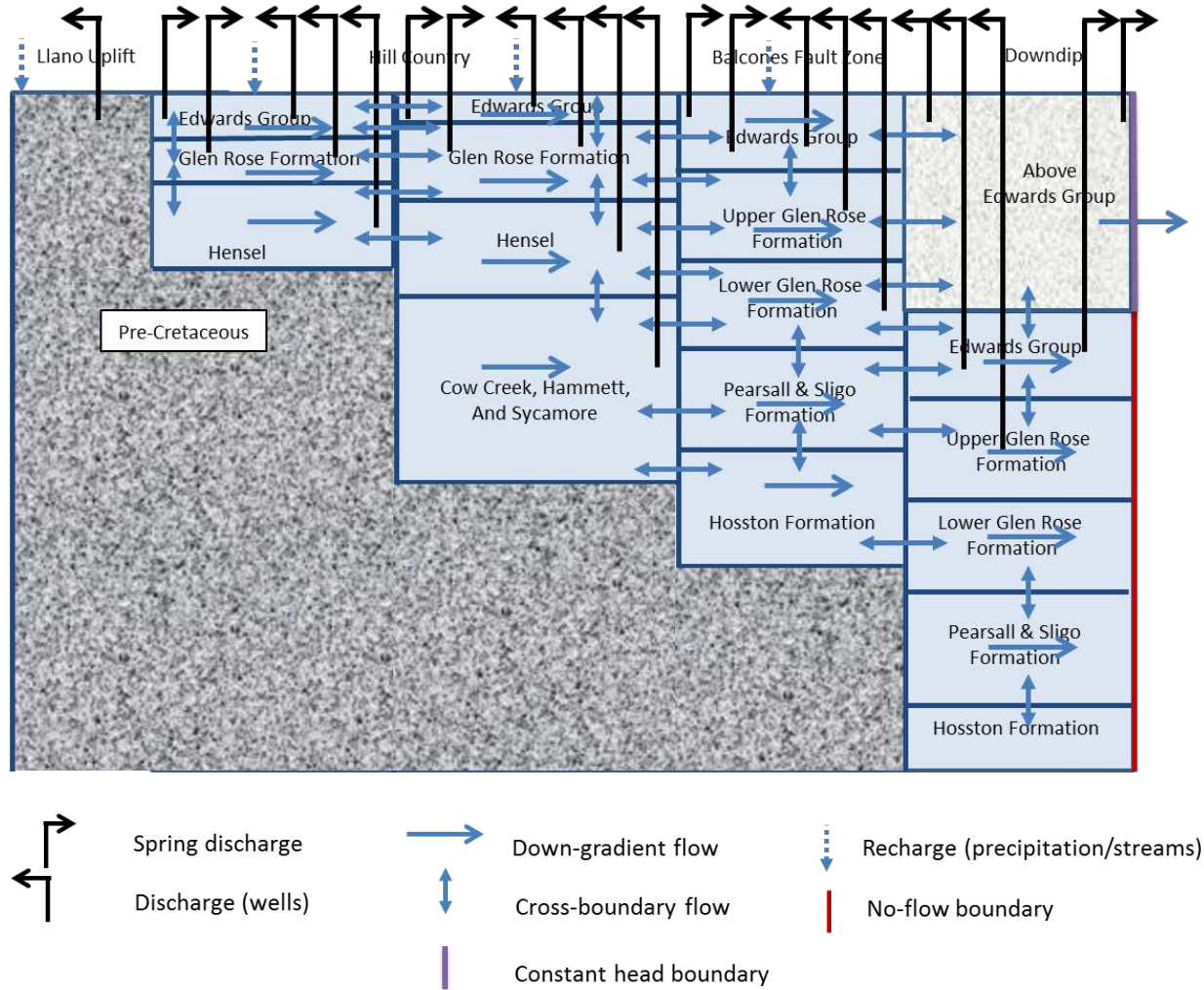

Figure 5.1.7 Block diagram of C-C' transect illustrating how the conceptual model translates to the numerical model.

Conceptual Model Report for the Hill Country Trinity Aquifer
Groundwater Availability Model

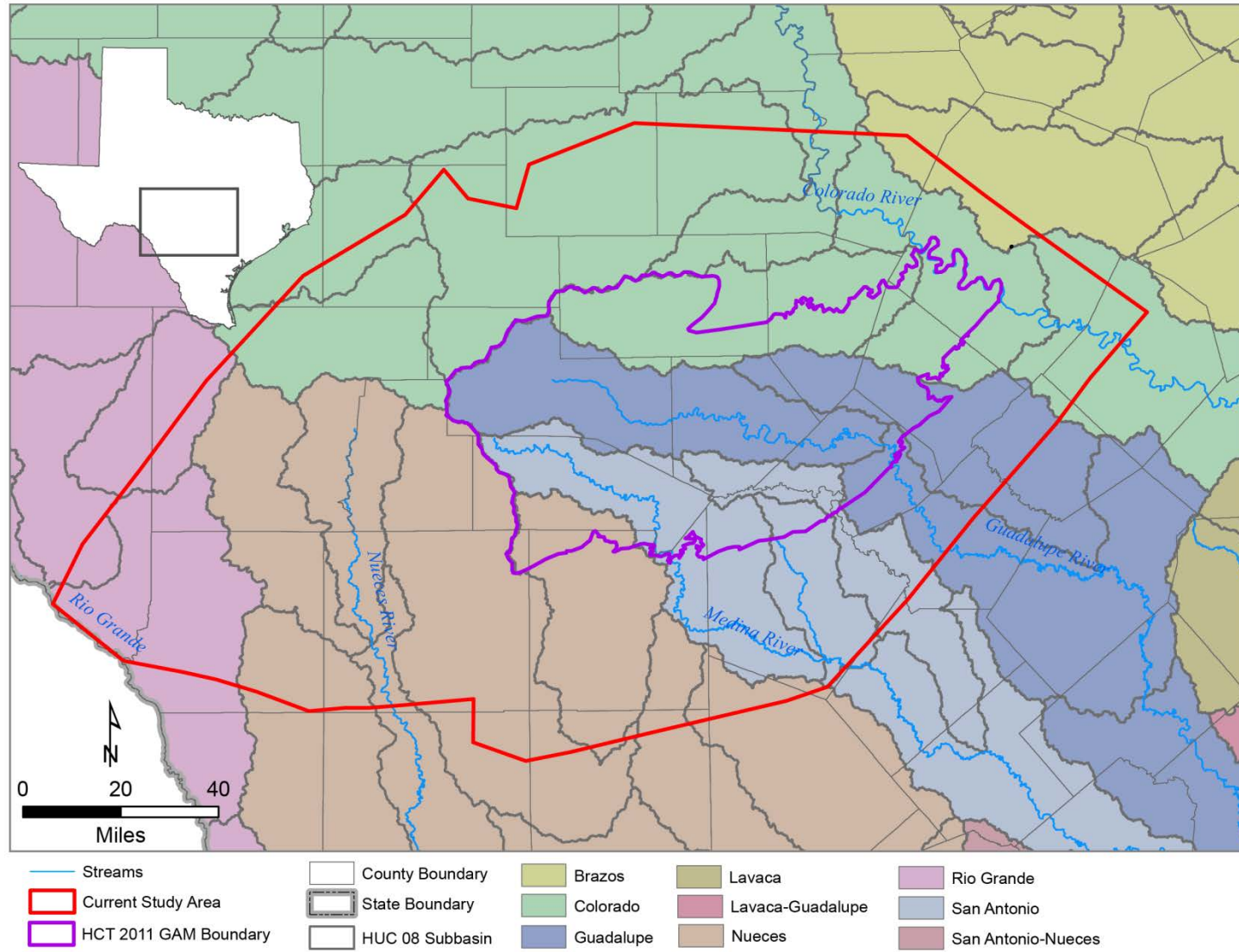

Figure 5.1.8 Map with study and model boundaries delineated.

5.2 Discharge

Natural discharge from the model domain occurs via inter-formational flow or where surface water flows out of the model domain (Figure 5.2.1). Anthropogenic discharge occurs via pumping. Given the choice of natural boundaries of the HCT Aquifer for the model domain, there is no groundwater flow outside of the model domain via the HCT Aquifer. Naturally-occurring discharge from the HCT Aquifer, however, does occur via inter-formational flow through other aquifers. Three cross sections were prepared to depict the variability in geologic structure and facies for the western, central, and eastern sectors of the HCT Aquifer. Two cross-sectional schematics were prepared for each transect. The first cross section for each transect is the hydrostratigraphic cross section (Figure 5.1.2, Figure 5.1.4, and Figure 5.1.6). The second cross section illustrates how the conceptual model translates to the numerical model (Figure 5.1.3, Figure 5.1.5, and Figure 5.1.7).

As illustrated, flow among the formations segmented by geologic structure is complex (Figure 5.1.2-5.1.7). In particular, the hydraulic relationship between the Edwards and Trinity aquifers is of critical importance when conceptualizing the HCT Aquifer mostly due to fact that these two formations are prolific aquifers with significant hydraulic communication. Groundwater from the HCT Aquifer can discharge to the Edwards (Balcones Fault Zone) Aquifer in two ways: (i) as subsurface cross-formational inflow across the updip margin of the Balcones Fault Zone where the Trinity Aquifer is juxtaposed with the downfaulted Edwards (Balcones Fault Zone) Aquifer and (ii) as upward flow from the Trinity Aquifer into the Edwards (Balcones Fault Zone) Aquifer along faults, fractures, and dissolution enhanced conduits. In addition, there is water that enters the Edwards (Balcones Fault Zone) Aquifer recharge zone from the HCT Aquifer as surface flow. The volume of inflow and outflow from the HCT Aquifer as groundwater is difficult to determine and is typically estimated or constrained using numerical groundwater-flow models and water-balance calculations.

The vertical cross-section conceptual models (Figure 5.1.2-7) are our best understanding of groundwater flow in the HCT Aquifer. Discharge via springs that is illustrated in the vertical schematics Figure 5.1.3, Figure 5.1.5, and Figure 5.1.7 was determined using a correlation of spring location and surface geology. Discharge via pumping wells that is illustrated in the vertical schematics Figure 5.1.3, Figure 5.1.5, and Figure 5.1.7 was determined using a correlation of well location and well formation designation (Figure 5.2.2-5.2.6). Five databases were queried for well location and well formation information: (i) TWDB groundwater database; (ii) Brackish Resources Aquifer Characterization System (BRACS) Database administered by the TWDB; (iii) Public Water Supply (PWS) database administered by the Texas Commission on Environmental Quality; (iv) Submitted Driller Reports (SDR) administered by the TWDB; and (v) U.S. Geological Survey. These databases are illustrated in five separate figures due to the high density of data (Figure 5.2.2-5.2.6). For wells with no formation designation, the depth of the well was used as a surrogate to estimate in which formation the well is set.

Conceptual Model Report for the Hill Country Trinity Aquifer
Groundwater Availability Model

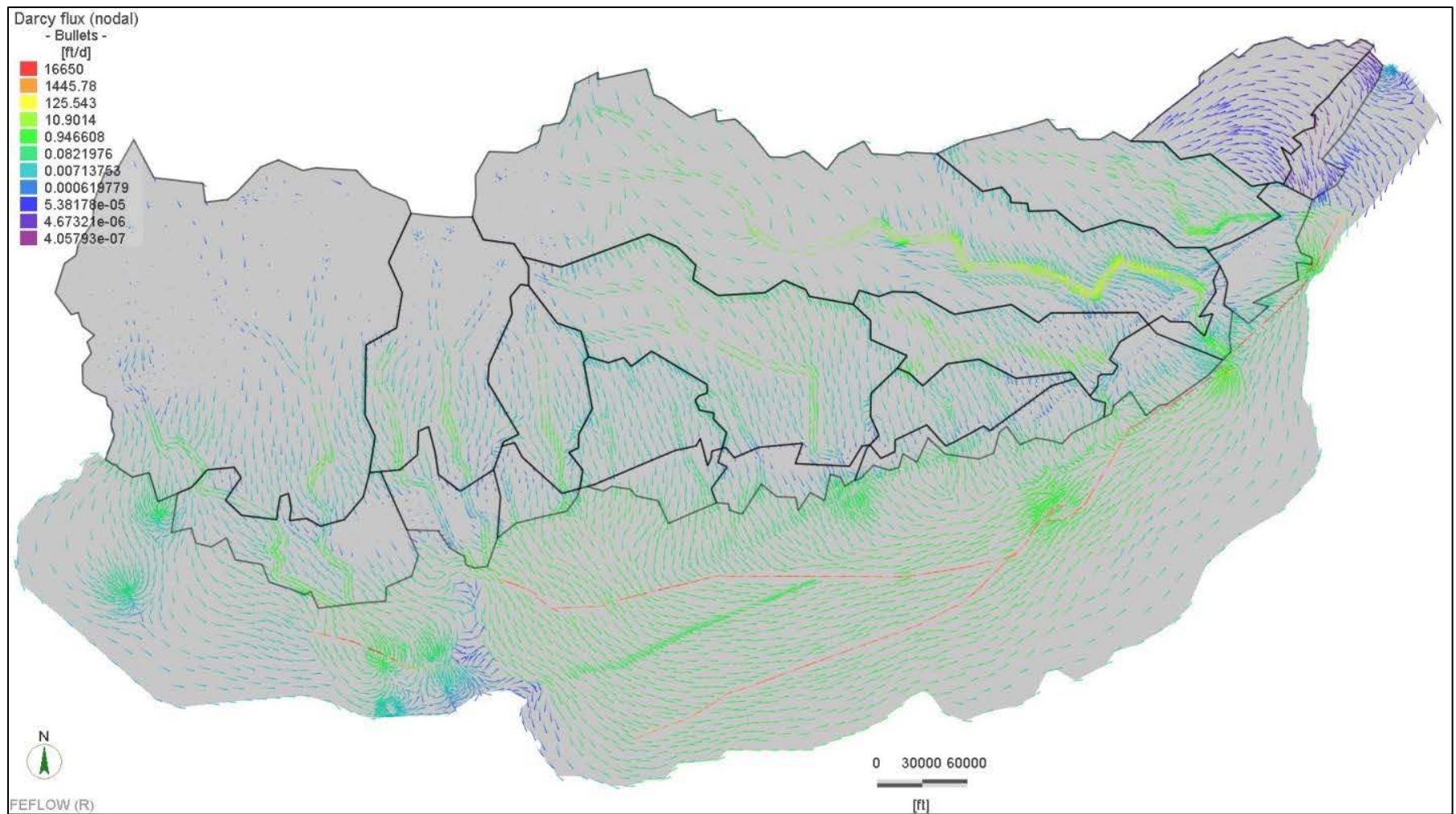

Figure 5.2.1 Direction of groundwater flow in the Edwards (Balcones Fault Zone) Aquifer (from Fratesi and others, 2015).

Conceptual Model Report for the Hill Country Trinity Aquifer
Groundwater Availability Model

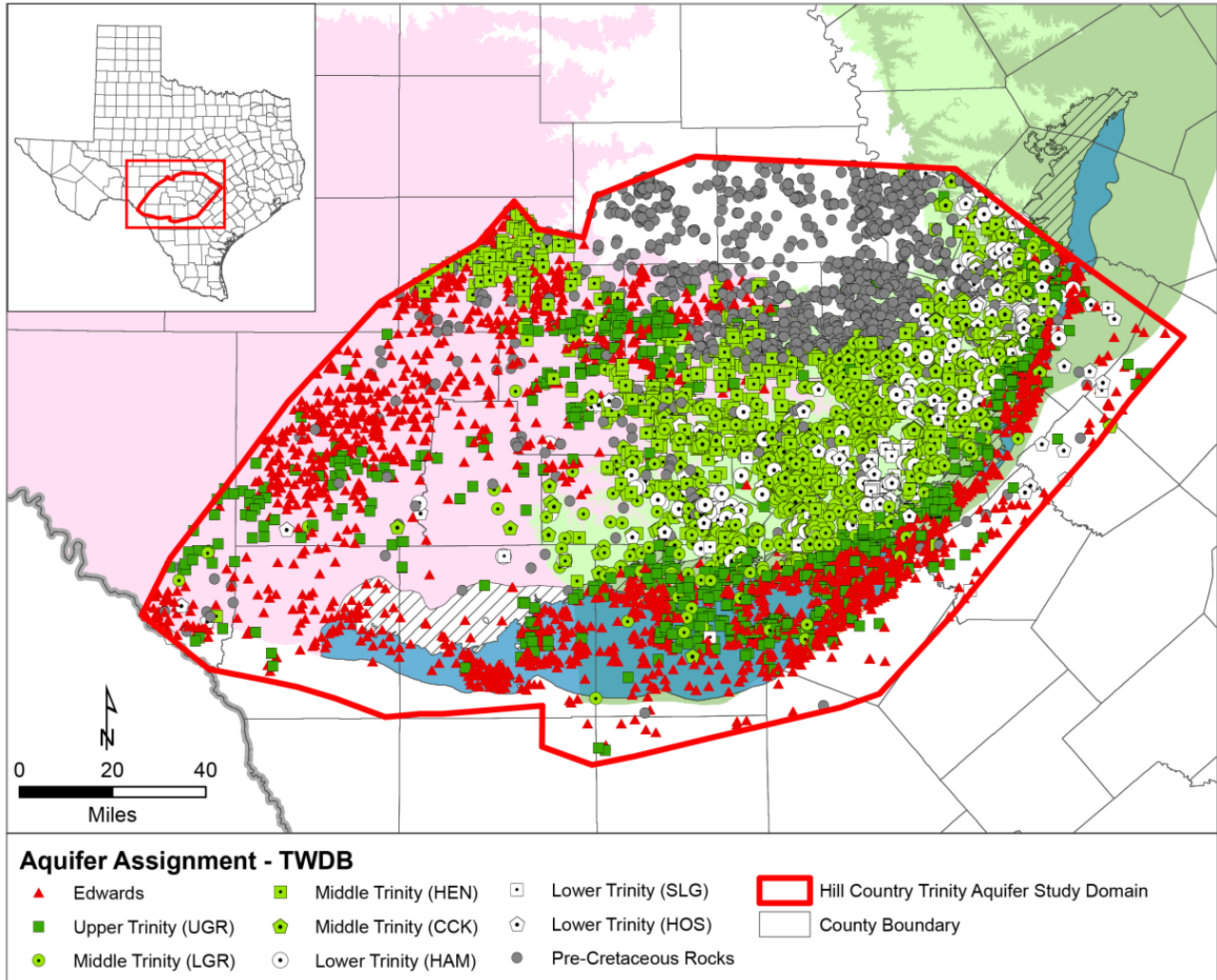

Figure 5.2.2 Water well locations designated by well formation from the TWDB groundwater database. Upper Trinity Aquifer includes: upper member of the Glen Rose Formation (UGR). Middle Trinity Aquifer includes: lower member of the Glen Rose Formation (LGR), Hensell Formation (HEN) and Cow Creek Formation (CCK). Lower Trinity Aquifer includes: Hammett Shale (HAM), Sligo Formation (SLG), and Hosston Formation (HOS).

Conceptual Model Report for the Hill Country Trinity Aquifer
Groundwater Availability Model

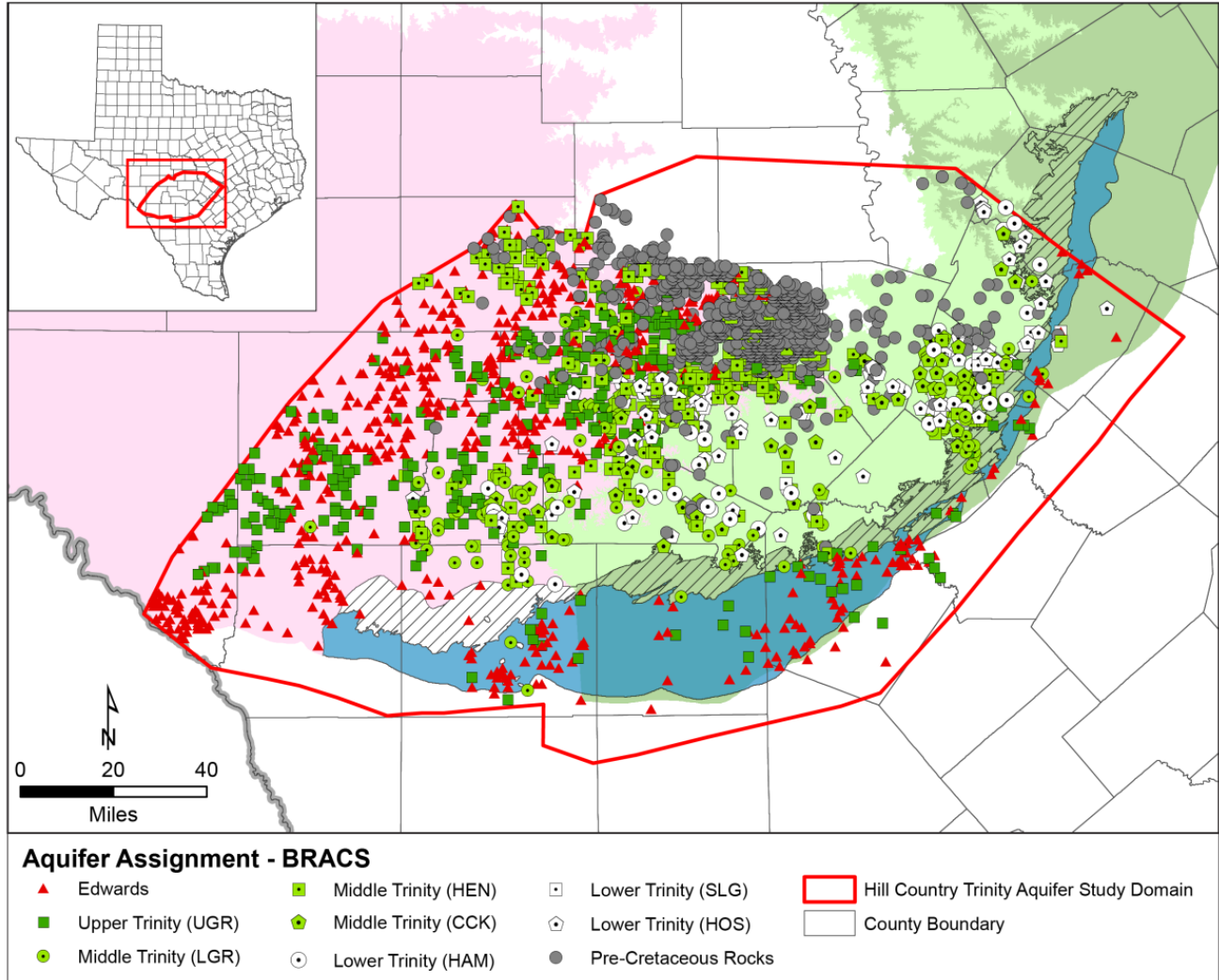

Figure 5.2.3 Water well locations designated by well formation from the Texas Brackish Resources Aquifer Characterization System (BRACS) Database. Upper Trinity Aquifer includes: upper member of the Glen Rose Formation (UGR). Middle Trinity Aquifer includes: lower member of the Glen Rose Formation (LGR), Hensell Formation (HEN) and Cow Creek Formation (CCK). Lower Trinity Aquifer includes: Hammett Shale (HAM), Sligo Formation (SLG), and Hosston Formation (HOS).

Conceptual Model Report for the Hill Country Trinity Aquifer
Groundwater Availability Model

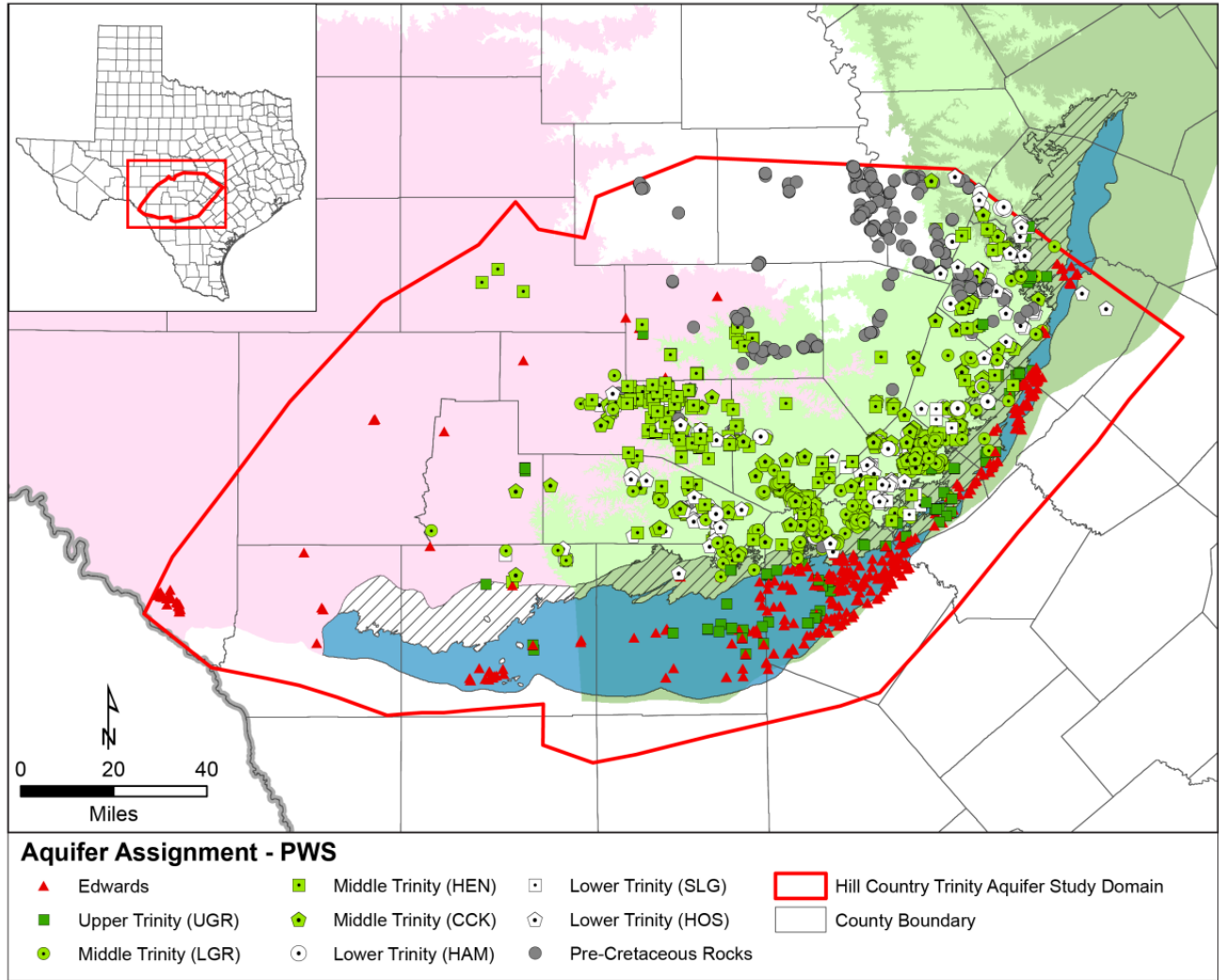

Figure 5.2.4 Water well locations designated by well formation from the Public Water Supply (PWS) database administered by the Texas Commission on Environmental Quality. Upper Trinity Aquifer includes: upper member of the Glen Rose Formation (UGR). Middle Trinity Aquifer includes: lower member of the Glen Rose Formation (LGR), Hensell Formation (HEN) and Cow Creek Formation (CCK). Lower Trinity Aquifer includes: Hammett Shale (HAM), Sligo Formation (SLG), and Hosston Formation (HOS).

Conceptual Model Report for the Hill Country Trinity Aquifer
Groundwater Availability Model

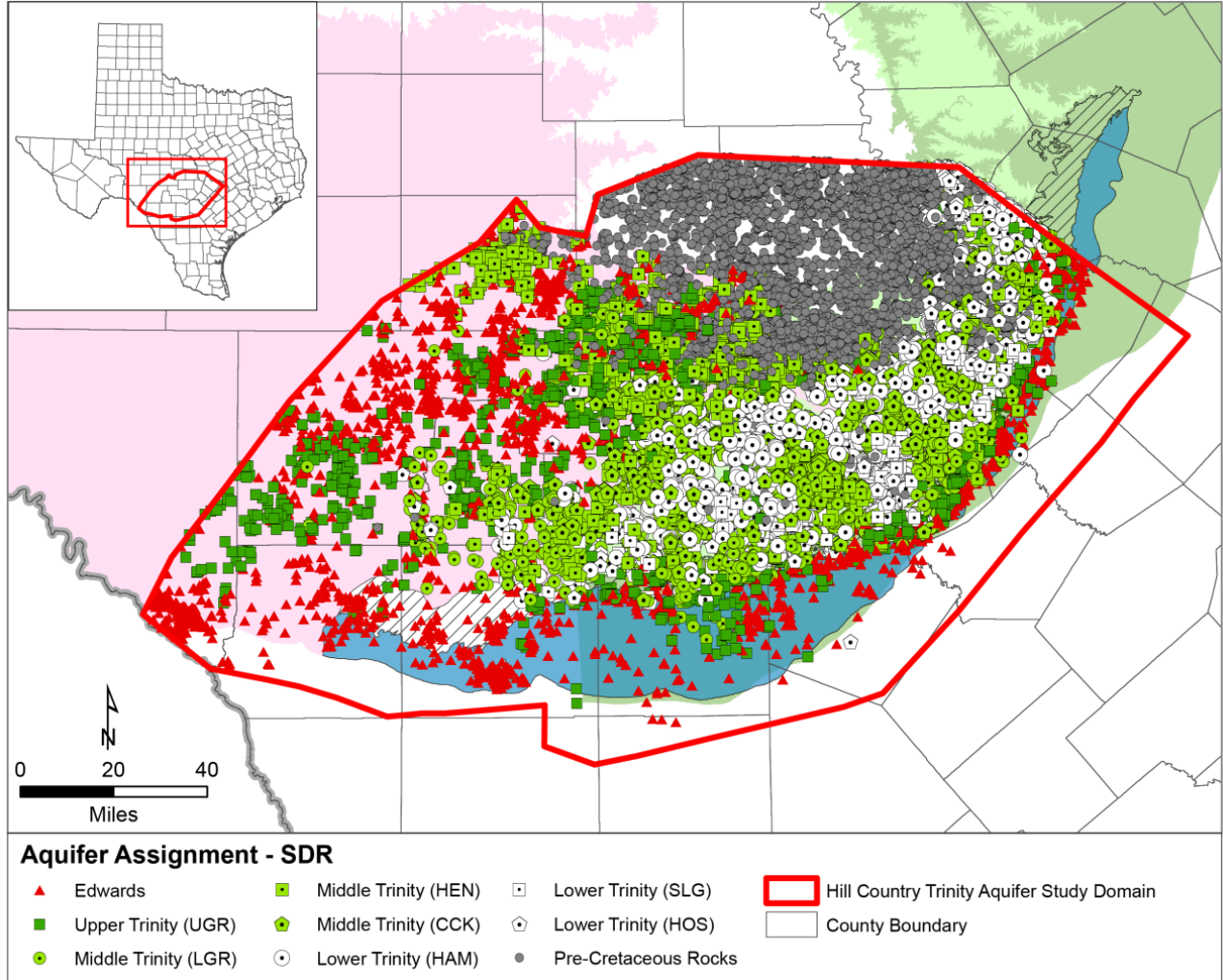

Figure 5.2.5 Water well locations designated by well formation from the Submitted Driller Reports (SDR). Upper Trinity Aquifer includes: upper member of the Glen Rose Formation (UGR). Middle Trinity Aquifer includes: lower member of the Glen Rose Formation (LGR), Hensell Formation (HEN) and Cow Creek Formation (CCK). Lower Trinity Aquifer includes: Hammett Shale (HAM), Sligo Formation (SLG), and Hosston Formation (HOS).

Conceptual Model Report for the Hill Country Trinity Aquifer
Groundwater Availability Model

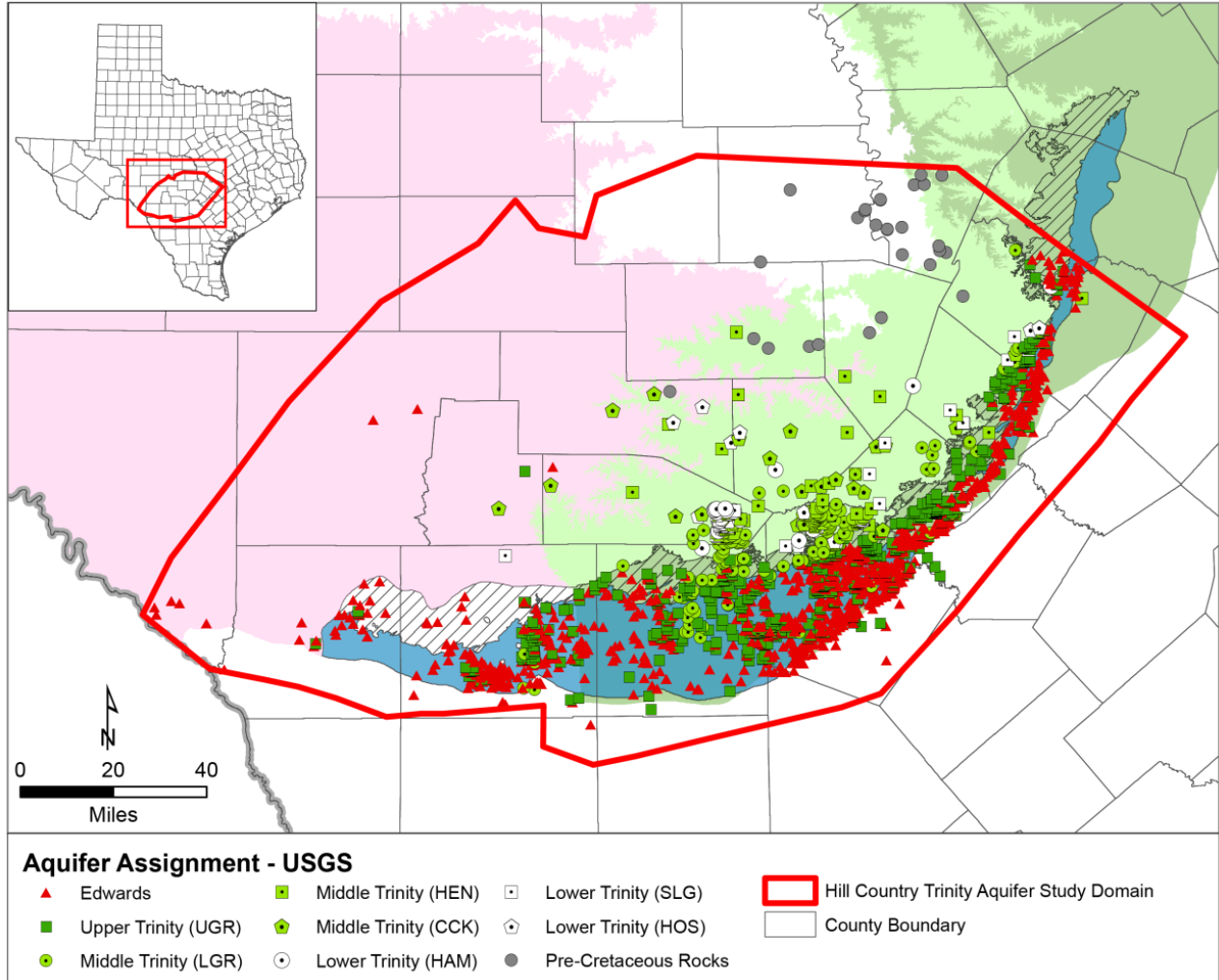

Figure 5.2.6 Water well locations designated by well formation from the U.S. Geological Survey. Upper Trinity Aquifer includes: upper member of the Glen Rose Formation (UGR). Middle Trinity Aquifer includes: lower member of the Glen Rose Formation (LGR), Hensell Formation (HEN) and Cow Creek Formation (CCK). Lower Trinity Aquifer includes: Hammett Shale (HAM), Sligo Formation (SLG), and Hosston Formation (HOS).

5.3 Recharge

Recharge to the HCT Aquifer occurs as a combination of diffuse and local recharge. The percentage of precipitation that ultimately infiltrates and recharges aquifers varies from as low as 1-2 percent in the western portion of the HCT Aquifer to as much as 30 percent in the eastern portion of the aquifer (Green and others, 2012; Hauwert and Sharp, 2014). These percentages vary seasonally and temporally in response to precipitation frequency and intensity, antecedent moisture, vegetation, soil and rock type, temperature, humidity, and other factors. As a consequence of these factors, the percentage of precipitation that recharges the HCT Aquifer is typically smaller in the west and greater in the east. The two most dominant factors that control the recharge fraction in central Texas are the higher rates of evapotranspiration in the west and the higher rates of precipitation in the east. Actual recharge rates have a high degree of uncertainty.

The HCT Aquifer is bounded above by the Edwards (Balcones Fault Zone) Aquifer and below by Pre-Cretaceous rocks. Groundwater flow in the overlying Edwards (Balcones Fault Zone) Aquifer generally coincides with the flow in the HCT Aquifer (Figure 5.2.1) (Fratesi and others, 2015). Groundwater flow in the formations above the Edwards (Balcones Fault Zone) Aquifer is only of concern in the Gulf Coast province in that it provides opportunities for discharge from the HCT Aquifer. In addition to recharging the HCT Aquifer, losing streams also recharge the Edwards Group where they cap the underlying Trinity Formation. This occurs at locations throughout the HCT Aquifer domain, but particularly in the northern and western portions of the HCT Aquifer where the aquifer domain extends into the eastern Edwards Plateau. The Edwards Plateau portion of the HCT Aquifer domain is important in that it contains the headwaters of several major river watersheds. Most of the recharge in the Edwards Group in the Edwards Plateau area discharges along the edge of the Edwards Plateau through springs, seeps, lower reaches of streams, and evapotranspiration. A small amount of the flow from the Edwards Group in the Edwards Plateau moves downward into the Upper and Middle Trinity aquifers.

6.0 References

- Abbott, P.L., 1966, The Glen Rose Section in the Canyon Reservoir Area Comal County, Texas.
- Alexander, W.H., Jr., and Patman, J. H., 1969, Ground-Water Resources of Kimble County, Texas: Texas Water Development Board Report 95, May 1969.
- Allan, U. S., 1989, Model for hydrocarbon migration and entrapment within faulted structures: American Association of Petroleum Geologists Bulletin, v. 73, no. 7, p. 803–811.
- Amsbury, D. L., 1974, Stratigraphic petrology of lower and middle Trinity rocks on the San Marcos platform, South-Central Texas: in B. F. Perkins, ed., *Geoscience and Man*, v. VIII: Louisiana State University Press, Baton Rouge, p. 1-35.
- Amsbury, D. L., 1988, The middle Comanchean section of Central Texas, in O. T. Hayward, ed., *Geological Society of America Centennial Field Guide, South-Central Section*, p. 373-376.
- Amsbury, D. L., 1996, Pearsall (Aptian Cretaceous) subsurface to outcrop sequence stratigraphy, Central Texas: *Gulf Coast Association of Geological Societies Transactions*, v. 46, p. 1-7.
- Amsbury, D. L., and Jones, J. O., 1996, A field book for the early Cretaceous rocks of South-Central Texas: South Texas Geological Society, prepared for the 46th Annual Meeting of the Gulf Coast Association of Geological Societies and the 45th Annual Meeting of the Gulf Coast Section SEPM, 99 p.
- Anaya, R. and Jones, I., 2009, Groundwater Availability Model for the Edwards-Trinity ((Plateau)) and Pecos Valley Aquifers of Texas. Texas Water Development Board Report 373. April 2009..
- Antonellini, M. and Aydin, A., 1994, Effect of faulting on fluid flow in porous sandstones: petrophysical properties. *AAPG bulletin*, v. 78 no. 3, p.355-377.
- Arnold, J. G., Allen, P. M., Muttiah, R., and Bernhardt, G., 1995, Automated Base Flow Separation and Recession Analysis Techniques. *Groundwater*, 33: 1010-1018.
doi:[10.1111/j.1745-6584.1995.tb00046.x](https://doi.org/10.1111/j.1745-6584.1995.tb00046.x)
- Arnold, J.G., and Allen, P.M., 1999, Automated methods for estimating baseflow and ground water recharge from streamflow records. *Journal of the American Water Resources Association* 35(2): 411-424.
- Arnow, T., 1963, Ground-Water Geology of Bexar County, Texas: Washington, D.C., U.S. G.P.O.
- Ashworth, J.B., 1983, Ground-water availability of the lower Cretaceous formations in the Hill Country of south-central Texas. Report 273. Texas Department of Water Resources. 39 p.
- Ashworth, J.B., Stein, W.G., Donnelly, A.C.A., Persky, K., and Jones, J.P. 2001, The lower Trinity aquifer of Bandera and Kerr counties, Texas, prepared for (Plateau) Regional Water Planning Group and Texas Water Development Board, 128 p.
- Bader, R.W., Walthour, S.D. and Waugh, J.R., 1993, Edwards (Balcones Fault Zone) Aquifer hydrologic status report for 1992.

Conceptual Model Report for the Hill Country Trinity Aquifer
Groundwater Availability Model

- Baker, B., Duffin, G., and Lynch, T., 1990a. Evaluation of water resources in part of Central Texas, Texas Water Development Board, Report 319, 43 p.
- Baker, B., Duffin, G., Flores, R., and Lynch T., 1990b, Evaluation of water resources in part of north-central Texas, Texas Water Development Board, Report 318, 67 p.
- Banta, J.R. and R.N. Slattery, 2011, Effects of Brush Management on the Hydrologic Budget and Water Quality In and Adjacent to Honey Creek State Natural Area, Comal County, Texas, 2001–10. US Geological Survey Scientific Investigations Report 2011-5226.
- Barker, R.A., Bush, P.W., and Baker, Jr., E.T., 1994. Geologic history and hydrogeologic setting of the Edwards-Trinity Aquifer system, west-central Texas, U.S. Geological Survey Water-Resources Investigations Report 94-4093. 55 p. Barker, R.A., and Ardis, A.F., 1996, Hydrogeologic framework of the Edwards-Trinity aquifer system, West-Central Texas: U.S. Geological Survey Professional Paper 1421-B. 61 p. with plates.
- Barnes, V.E., 1977, Geologic atlas of Texas, Del Rio Sheet: The University of Texas at Austin, Bureau of Economic Geology, 8 p., scale 1:250,000, 1 sheet.
- Barnes, V.E., 1979, Geologic atlas of Texas, Seguin Sheet: The University of Texas at Austin, Bureau of Economic Geology, 8 p., scale 1:250,000, 1 sheet.
- Barnes, V.E., 1980, Geologic atlas of Texas, Sonora Sheet: The University of Texas at Austin, Bureau of Economic Geology, 8 p., scale 1:250,000, 1 sheet.
- Barnes, V.E., 1981a, Geologic atlas of Texas, Llano Sheet: The University of Texas at Austin, Bureau of Economic Geology, 8 p., scale 1:250,000, 1 sheet.
- Barnes, V.E., 1981b, Geologic atlas of Texas, Austin Sheet: The University of Texas at Austin, Bureau of Economic Geology, 8 p., scale 1:250,000, 1 sheet.
- Barnes, V.E. 1983. Geologic atlas of Texas, San Antonio sheet: Austin, University of Texas, Bureau of Economic Geology, 8 p., scale 1:250,000, 1 sheet.
- Barton Springs Edwards (Balcones Fault Zone) Aquifer Conservation District, 2017, Central Texas Water Resources.
- Bebout, D. G., and Loucks, R.G., 1974, Stuart City Trend, Lower Cretaceous, South Texas—A carbonate shelf-margin model for hydrocarbon exploration: Texas Bureau of Economic Geology Report of Investigations 78, Austin, 80 p.
- Bebout, D.G., 1977, Sligo and Hosston depositional patterns, subsurface of South Texas. In: Cretaceous Carbonates of Texas and Mexico: Applications to Subsurface Exploration (Eds D.G. Bebout and R.G. Loucks), Bur. Econ. Geol. Univ. Tex. Austin Rep. Inv., 89, 79–96.
- Bebout, D.G., Budd, D.A., and Schatzinger, R.A., 1981, Depositional and Diagenetic History of the Sligo and Hosston Formations (Lower Cretaceous) in South Texas, by 69 p., 55 figs., 4 tables.
- Bluntzer, R.L., 1992, Evaluation of ground-water resources of the Paleozoic and Cretaceous aquifers in the Hill Country of Central Texas: Texas Water Development Board Report 339, 161 p.

Conceptual Model Report for the Hill Country Trinity Aquifer
Groundwater Availability Model

- Broadhurst, W.L., Sundstrom, R.W., and Rowley, J.H., 1950, Public Water Supplies in Southern Texas, Geological Survey Water-Supply Paper 1070: Prepared by Water Resources Division, in cooperation with the Texas State Board of Water Engineers.
- Broadhurst, W. L., Sundstrom, R.W., and Weaver, D.E., 1951, Public Water Supplies in Western Texas, Geological Survey Water-Supply Paper 1106: Prepared by Water Resources Division in cooperation with the Texas State Board of Water Engineers.
- Broun, A. S., Wierman, D.A., Backus, A.H., and Hunt, B.B., 2007, Geological analysis of the Trinity Group aquifers in western Hays County, Texas with focus on implications to groundwater availability: in B.B. Hunt, C. M. Woodruff, Jr., and E.W. Collins, eds., Reimers Ranch and Westcave Preserve: Landscapes, water, and Lower Cretaceous stratigraphy of the Pedernales watershed, western Travis County, Texas, Austin Geological Society, Guidebook 28, October 20, 2007, p. 64-81.
- Broun, A. S., Wierman, D.A., Backus, A.H., and Llano, L., 2008a, Cypress Creek/Jacob's Well Hydrogeologic Report, Hays Trinity Groundwater Conservation District, December 2008, 43 p.
- Broun, A. S., L. Llano, D. A. Wierman, and A. H. Backus, 2008b, The Geology of the Cypress Creek Watershed, Wimberley Area, Texas: Austin Geological Society, Austin, Texas, AGS Bulletin, Vol. 4, 2007-2008, p. 23-34.
- Brown, D.S., 1999, Geologic framework and hydrogeologic properties of the Seco Creek Watershed, Texas, U.S. Geological Survey fact sheet.
- Brune, G., 1975, Major and historical springs of Texas. Report 189. Texas Water Development Board.
- Brune, G., and Duffin, G.L., 1983, Occurrence, availability, and quality of ground water in Travis County, Texas: Texas Department of Water Resources Report 276, 103 p.
- Bush, PW, Ardis, A.F., and Wynn, K.H., 1993, Historical potentiometric surface of the Edwards-Trinity aquifer system and contiguous hydraulically connected units, west-central Texas: U.S. Geological Survey Water-Resources Investigations Report 92-4055, 3 sheets.
- Caine, J.S., Evans, J.P. and Forster, C.B., 1996, Fault zone architecture and permeability structure. *Geology*, v. 24, no.11, p.1025-1028.
- Childs, C., Watterson, J., Walsh, J.J., 1995. Fault overlap zones within developing normal fault systems. *Journal of the Geological Society*, London 152, 535–549.
- Christian, B., and Wuerch, D., 2012, Compilation of Results of Aquifer Tests in Texas. Texas Water Development Board Report 381. April 2012.
- Chowdhury, A.H., 2009, A comparison of the old and new groundwater availability models for the Hill Country portion of the Edwards and Trinity Aquifers: Texas Water Development Board, Analysis Paper 09-20, 32 p.
- Clark, A.K., 2000, Vulnerability of ground water to contamination, Edwards Aquifer recharge zone, Bexar County, Texas, 1998 (No. 2000-4149), US Geological Survey.
- Clark, A.K., and Journey, C., 2006, Flow paths in the Edwards aquifer, northern Medina and northeastern Uvalde Counties, Texas, based on hydrologic identification and geochemical

Conceptual Model Report for the Hill Country Trinity Aquifer
Groundwater Availability Model

- characterization and simulation (No. 2006-5200). US Geological Survey. Accessed July 11, 2017.
- Clark, A.K., Golab, J.A., and Morris, R.R., 2016, Geologic framework and hydrostratigraphy of the Edwards and Trinity aquifers within northern Bexar and Comal Counties, Texas: U.S. Geological Survey Scientific Investigations Map 3366, 1 sheet, scale 1:24,000, pamphlet, <https://doi.org/10.3133/sim3366>.
- Collins, E. W., and Hovorka, S. D., 1997, Structure map of the San Antonio segment of the Edwards Aquifer and Balcones Fault Zone, south-central Texas: structural framework of a major limestone aquifer: Kinney, Uvalde, Medina, Bexar, Comal and Hays Counties: The University of Texas at Austin, Bureau of Economic Geology, Miscellaneous Map No. 38, scale 1:250,000, text, 14 p.
- Collins, E. W., 2000, Geologic map of the New Braunfels, Texas, 30 × 60 minute quadrangle: Geologic framework of an urban-growth corridor along the Edwards aquifer, south-central Texas: University of Texas at Austin Bureau of Economic Geology Miscellaneous Map No. 39, 28 p., scale 1:100,000, 1 sheet.
- Cope, E. D., 1880, On the zoological position of Texas: Washington, DC, U.S. Natural History Museum Bulletin, v. 17, 51 p.
- Daniel B. Stephens & Associates, Inc., 2006, Aquifer Tests from County Availability Studies. Prepared for Texas Water Development Board under TWDB Contract # 2005-483-554. May 4, 2006.
- Darling, B.K., 2016, Geochemical evaluation of hydrogeologic interaction between the Edwards and Trinity Aquifers – Travis, Hays and Comal counties, Texas. Presentation March 2016 access from Researchgate, May 15, 2018.
- DeCook, K.J., 1963, Geology and ground-water resources of Hays County, Texas, U.S. Geological Survey Water-Supply Paper 1612. 80 p.
- Doctor, D.H., Jr., Alexander, E.C., Jr., Petrič, M., Kogovšek, J., Urbanc, J., Lojen, S., Stichler, W., 2006, Quantification of karst aquifer discharge components during storm events through end-member mixing analysis using natural chemistry and stable isotopes as tracers: *Hydrogeol. J.*, 14 (1) (2006), 10.1007/s10040-006-0031-6.
- Duffin, G., and Musick, S.P., 1991, Evaluation of water resources in Bell, Burnet, Travis, Williamson, and parts of adjacent counties, Texas: Texas Department of Water Resources Report 326, 105 p.
- Dugas, W.A., R.A. Hicks, and P. Wright, 1998, Effect of Removal of *Juniperus ashei* on Evapotranspiration and Runoff in the Seco Creek Watershed. *Water Resources Research*, 34, 1499-1506.
- Espey, Huston & Associates, Inc. 1989, Medina Lake Hydrogeology Study. Contract report for the Edwards Underground Water District prepared by Espey, Huston & Associates, Inc. 26 p + attachments.
- Ewing, T. E., 1991, The tectonic framework of Texas: text to accompany “The Tectonic Map of Texas”: Texas Bureau of Economic Geology, Austin, 36 p.

Conceptual Model Report for the Hill Country Trinity Aquifer
Groundwater Availability Model

- Fahlquist, L., and Ardis, A.F., 2004, Quality of water in the Trinity and Edwards aquifers, south-central Texas, 1996–98: U.S. Geological Survey Scientific Investigations Report 2004–5201.
- Farlow, J.O., Langston, W. Jr., Deschner, E. E., Solis, R., Ward, W., Kirkland, B. L., Hovorka, S., Reece, T. L. and Whitcraft, J., 2006, Texas Giants, Dinosaurs of the Heritage Museum of the Texas Hill Country: The Heritage Museum of the Texas Hill Country, 150 p.
- Ferrill, D.A., Stamatakos, J.A., Sims, D., 1999. Normal fault corrugation: Implications for growth and seismicity of active normal faults. *Journal of Structural Geology* 21, 1027–1038.
- Ferrill, D.A., Winterle, J., Wittmeyer, G., Sims, D., Colton, S., Armstrong, A. and Morris, A.P., 1999, Stressed rock strains groundwater at Yucca Mountain, Nevada: *GSA Today*, v. 9, no. 5, p.1-8.
- Ferrill, D.A., Morris, A.P., Stamatakos, J.A. and Sims, D.W., 2000, Crossing conjugate normal faults: *AAPG bulletin*, v. 84, no. 10, p.1543-1559.
- Ferrill, D.A. and Morris, A.P., 2001, Displacement gradient and deformation in normal fault systems: *Journal of Structural Geology*, v. 23, no. 4, p.619-638.
- Ferrill, D.A. and Morris, A.P., 2003, Dilational normal faults: *Journal of Structural Geology*, v. 25, no. 2, p.183-196.
- Ferrill, D.A., Sims, D.W., Morris, A.P., Waiting, D.J., and Franklin, N., 2003, Structural Controls on the Edwards Aquifer/Trinity Aquifer Interface in the Camp Bullis Quadrangle, Texas Final report prepared for the Edwards (Balcones Fault Zone) Aquifer Authority and the US Army Corps of Engineers.
- Ferrill, D.A., Sims, D.W., Morris, A.P., Waiting, D.J., Franklin, N., and Schultz, A.L., 2004, Structural Framework of the Edwards Aquifer recharge zone in southcentral Texas: *Geological Society of America Bulletin*, v. 116, no. 3, p. 407–418, doi:10.1130/B25174.1.
- Ferrill, D.A., Sims, D.W., Franklin, N., Morris, A.P., and Waiting, D.J., 2005, Structural Controls on the Edward Aquifer/Trinity Aquifer Interface in the Helotes Quadrangle, Texas. Final report prepared for the Edwards Aquifer Authority and the US Army Corps of Engineers. 167.
- Ferrill, D.A., and Morris, A.P., 2008, Fault zone deformation controlled by carbonate mechanical stratigraphy, Balcones fault system, Texas. *AAPG Bull.* 92, 359–380.
- Ferrill, D. A., Morris, A. P., Sims, D. W., Green, R., Franklin, N., and Waiting, D. J., 2008, Geologic controls on interaction between the Edwards and Trinity aquifers, Balcones fault system, Texas: *South Texas Geological Society Bulletin*, v. 41, p. 21–45.
- Ferrill, D. A., Morris, A. P., and McGinnis, R. N., 2009, Crossing conjugate normal faults in field exposures and seismic data: *AAPG Bulletin*, v. 93, p. 1471–1488
- Ferrill, D.A., Morris, A.P. McGinnis, R.N., Smart, K.J., and Ward, W.C., 2011, Fault zone deformation and displacement partitioning in mechanically layered carbonates: The Hidden Valley fault, central Texas. *AAPG Bull.* 95, 1383–1397.

Conceptual Model Report for the Hill Country Trinity Aquifer
Groundwater Availability Model

- Ferrill, D. A., R. N. McGinnis, A. P. Morris, and K. J. Smart, 2012, Hybrid failure: Field evidence and influence on fault refraction: *Journal of Structural Geology*, v. 42, p. 140–150, doi:10.1016/j.jsg.2012.05.012.
- Finkbeiner, T., Barton, C.A. and Zoback, M.D., 1997, Relationships among in-situ stress, fractures and faults, and fluid flow: Monterey Formation, Santa Maria Basin, California: AAPG bulletin 81 no.12, p.1975-1999.
- Fisher, R.V., 1983, Flow transformations in sediment gravity flows. *Geology*, v. 11, no. 5, p.273-274.
- Flawn, P.T., A. Goldstein, Jr., P. B. King and C. E. Weaver, 1961, The Ouachita System: University of Texas, Austin, Bureau of Economic Geology Publication 6120, 401 p.
- Foley, L.L., 1926, Mechanics of the Balcones and Mexia faulting: *Bulletin of the American Association of Petroleum Geologists*, v. 10, no. 12, p. 1261–1269.
- Follett, C.R., 1966, Ground-water resources of Caldwell County, Texas, Texas Water Development Board, Report 174, 133 p.
- Follett, C.R., 1973, Ground-water resources of Blanco County, Texas, Texas Water Development Board, Report 12, 135 p.
- Fratesi, B.S., Green, R.T., Bertetti, P.F., McGinnis, R.N., Toll, N., Başağaoğlu, H., Gergen, L., and Winterle, J.R., 2015, Development of a Finite-Element Method Groundwater Flow model for the Edwards Aquifer: Prepared for the Edwards Aquifer Authority, 180p.
- Fry, J., Xian, G.Z., Jin, S., Dewitz, J., Homer, C.G., Yang, L., Barnes, C.A., Herold, N.D. and Wickham, J.D., 2011, Completion of the 2006 national land cover database for the conterminous United States. *Photogrammetric engineering and remote sensing*, v. 77, no. 9, p.858-864.
- Frye R.G., Brown, K.L., and McMahan, C.A., and others 1984, The Vegetation Types of Texas: Texas Parks and Wildlife Department, 1p.
- Gary, Marcus, 2018, Personal communication regarding EAA Interformational Flow Study.
- George, P.G., Mace, R.E., and Petrossian, R., 2011, Aquifers of Texas: Texas Water Development Board Report 380, 172 p.
- George, W.O., Cumley, J.C., and Follett, C.R., 1941, Records of wells and springs, drillers logs, water analyses, and map showing locations of wells and springs in Travis County Texas: Texas Board of Water Engineers duplicated report.
- George, W.O., 1947, Geology and Ground-Water Resources of Comal County, Texas: Texas Board of Water Engineers Report, February 1947.
- George, W.O., Breeding, S.D., and Hastings, W.W., 1952, Geology and ground-water resources of Comal County, Texas, U.S. Geological Survey Water-Supply Paper 1138, 140 p.
- GMA-9, 2016, Groundwater Management Area 9 Explanatory Report for Desired Future Conditions Major and Minor Aquifers, Blanton & Associates and LBG Guyton, Report April 18, 2016. 191 pg.

Conceptual Model Report for the Hill Country Trinity Aquifer
Groundwater Availability Model

- Green, R.T., Winterle, J.R. and Prikryl, J.D., 2008, Discharge From the Edwards Aquifer Through the Leona River Floodplain, Uvalde, Texas, *JAWRA Journal of the American Water Resources Association* 44 no.4, p.887-901.
- Green, R.T., Bertetti, F.P., and Candelario, M.O., 2011, Edwards Aquifer–Upper Glen Rose aquifer hydraulic interaction. In *Interconnection of the Trinity (Glen Rose) and Edwards Aquifers along the Balcones Fault Zone and Related Topics*, Proceedings from Karst Conservation Initiative Meeting, February 17, pp. 30–35.
- Green, R., Bertetti, F.P., and Hernandez, M., 2012, Recharge Variability In Semi-Arid climates. *Nature Education Knowledge* 3(10):34.
<http://www.nature.com/scitable/knowledge/library/recharge-variability-in-semi-arid-climates-26169682>
- Griffith, G., Bryce, S., Omernik, J., and Rogers, A., 2007, Ecoregions of Texas. Project report to Texas Commission on Environmental Quality, 134 p.
- Guyton, W.F. and Rose, N.A., 1945, Quantitative studies of some artesian aquifers in Texas: *Economic Geology*, v. 40, No.3, p. 193-226.
- Guyton, W.F., and Associates, 1958, Recharge to the Edwards reservoir between Kyle and Austin: consulting report prepared for San Antonio City Water Board.
- Guyton, W.F., and Associates. 1970, Ground water conditions in Angelina and Nacogdoches Counties, Texas. Texas Water Development Board. Report No. 110.
- Halbouty, M. T., 1966, Stratigraphic-trap possibilities in upper Jurassic rocks, San Marcos Arch, Texas: *AAPG Bulletin*, v. 50, no. 1, p. 3–24.
- Hamlin, S., and Anaya, R., 2006, Texas Water Development Board GAM technical memo 06-01.
- Hammond, W. W., 1984, Hydrogeology of the Lower Glen Rose Aquifer, South-Central Texas: Ph.D.dissertation, The University of Texas at Austin. 243 p.
- Hauwert, N., 2009, Groundwater flow and recharge within the Barton Springs Segment of the Edwards Aquifer, southern Travis County and northern Hays Counties, Texas: Dissertation, University of Texas at Austin, Texas. Available at <https://repositories.lib.utexas.edu/handle/2152/14107>. Accessed November 3, 2016.
- Hauwert, N.M., 2011, Water Budget of Stream Recharge Sources to the Barton Springs Segment of the Edwards Aquifer: City of Austin Watershed Protection Department Report. 25 p.
- Hauwert, N.M., and Sharp, J.M., Jr., 2014, Measuring Autogenic Recharge over a Karst Aquifer Utilizing Eddy Covariance Evapotranspiration. *Journal of Water Resource and Protection*. 6. 869-879. <http://dx.doi.org/10.4236/jwarp.2014.69081>
- Hayes, M.E., 2000. Major Aquifers of Texas (map). Texas Water Development Board (TWDB), Austin, Texas: <http://www.twdb.state.tx.us/mapping/maps/pdf/aqumaj24x24.pdf>.
- Hill, R. T., 1889, A brief description of the Cretaceous rocks of Texas and their economic value, in E. T. Dumble, ed., *First annual report of the Geological Survey of Texas*: Texas Department of Agriculture, Insurance, Statistics, and History, Austin, Texas, p. 105–141.
- Hill, R.T., 1890, A Brief Description of the Cretaceous Rocks of Texas and Their Economic Value, *First Annual Report of the Geological Survey of Texas*, 1889, p. 105–141.

Conceptual Model Report for the Hill Country Trinity Aquifer
Groundwater Availability Model

- Hill, R.T., 1891. The Comanche series of the Texas-Arkansas region. Bulletin of the Geological Society of America, v. 2, no.1, p.503-528.
- Homer, C., Dewitz, J., Fry, J., Coan, M., Hossain, N., Larson, C., Herold, N., McKerrow, A., VanDriel, J.N., and Wickham, J, 2007, [Completion of the 2001 National Land Cover Database for the Conterminous United States](#). *Photogrammetric Engineering and Remote Sensing*, Vol. 73, No. 4, pp 337-341.
- Homer, C.G., Dewitz, J.A., Yang, L., Jin, S., Danielson, P., Xian, G., Coulston, J., Herold, N.D., Wickham, J.D., and Megown, K., 2015, [Completion of the 2011 National Land Cover Database for the conterminous United States-Representing a decade of land cover change information](#). *Photogrammetric Engineering and Remote Sensing*, v. 81, no. 5, p. 345-354.
- Hovorka, S.D., Mace, R.E., and Collins, E.W., 1998, Permeability structure of the Edwards Aquifer, South Texas—Implications for aquifer management: The University of Texas at Austin, Bureau of Economic Geology Report of Investigations, v. 250, 55 p.
- Hunt, B.B., B.A. Smith, and J. Beery, 2007, Potentiometric maps for low to high flow conditions, Barton Springs segment of the Edwards Aquifer, Central Texas: Barton Springs/Edwards Aquifer Conservation District, Report of Investigations 2007-1201, 65 p. +CD. December 2007.
- Hunt, B.B. and Smith, B.A., 2010, Spring 2009 Potentiometric Map of the Middle Trinity Aquifer in Groundwater Management Area 9, Central Texas. BSEACD Report of Investigations 2010-0501, 2010.
- Hunt, B.B., Smith, B.A., Kromann, J., Wierman, D.A., and Mikels, J.K., 2010, Compilation of pumping tests in Travis and Hays counties, central Texas. Barton Springs/Edwards Aquifer Conservation District Data Series Report 2010-0701. 86 p.
- Hunt, B.B., B.A. Smith, A. Andrews, D.A. Wierman, A.S. Broun, and M.O. Gary, 2015, Relay ramp structures and their influence on groundwater flow in the Edwards and Trinity Aquifers, Hays and Travis Counties, Central Texas, Sinkhole Conference, October 5-10, 2015, Rochester, Minnesota
- Hunt, B.B., Smith, B.A., Gary, M.O., Broun, A.S., Wierman, D.A., Watson, J., and Johns, D., 2015, Surface-water and Groundwater Interactions in the Blanco River and Onion Creek Watersheds: Implications for the Trinity and Edwards Aquifers of Central Texas, South Texas Geological Society, 22 p.
- Hunt, B.B., Andrews, A.,G., and Smith, B.A., 2016, Hydraulic Conductivity Testing in the Edwards and Trinity Aquifers using multiport monitor well systems, Hays County, Central Texas, Barton Springs/Edwards Aquifer Conservation District Data Series Report 2016-0831. 43 p.
- Huggins, P., Watterson, J., Walsh, J. J., Childs, C., 1995. Relay zone geometry and displacement transfer between normal faults recorded in coal-mine plans. *Journal of Structural Geology* 17, 1741–1755.
- Hutchison, W. R. 2010. GAM Task 10-005, Texas Water Development Board Groundwater Resources Division.

Conceptual Model Report for the Hill Country Trinity Aquifer
Groundwater Availability Model

- Imlay, R. L., 1945, Subsurface Lower Cretaceous formations of south Texas: American Association of Petroleum Geologists Bulletin, v. 29, no. 10, pp. 1416-1469.
- Inden, R.F., 1974. Lithofacies and depositional model for a Trinity Cretaceous depositional sequence, central Texas. Aspects of Trinity Division geology: Louisiana University Press, Geoscience and Man, v.7, p.37-52.
- Inden, R. F. and Moore, C. H. Jr., 1983, Beach environment, in P. A. Scholle, D. G. Bebout, and C. H. Moore Jr., eds., Carbonate depositional environments: American Association of Petroleum Geologists Memoir 33, p. 211-265.
- Johnson, S. B., Schindel, G. M., and Hoyt, J. R., 2002, Groundwater chemistry changes during a recharge event in the karstic Edwards Aquifer, San Antonio, Texas, Geological Society of America, Online Abstract 186-8
- Johnson, S.B., and Schindel, G.M., 2008, Evaluation of the option to designate a separate San Marcos pool for critical period management: San Antonio, Tex., Edwards Aquifer Authority, 109 p.
- Johnson, S., Schindel, G.M., and Veni, G., 2010a, Dye tracer tests in the Edwards Aquifer, Balcones Fault Zone, San Antonio Segment, Bexar County, Panther Springs Creek. Edwards Aquifer Authority. Report 10-01. 112 pp.
- Johnson, S., Schindel, G.M., and Veni, G., 2010b, Tracing groundwater flowpaths in the Edwards Aquifer Recharge Zone, Panther Springs Creek Basin, northern Bexar County, Texas. Report No. 10-01, 39.
- Johnson, S., Schindel, G., Veni, G., Hauwert, N., Hunt, B., Smith, B., and Gary, M., 2012, Tracing groundwater flowpaths in the vicinity of San Marcos Springs, Texas. Edwards Aquifer Authority. Report No. 12-01. 99 pp + attachments.
- Jones, I.C., Anaya, R., and Wade, S.C., 2011, Groundwater Availability Model: Hill Country Portion of the Trinity Aquifer of Texas: Texas Water Development Board Report 377, 165 p.
- Jones, I.C., 2011, Interaction between the Hill Country portion of the Trinity and Edwards aquifers: model results: in Gary, M.O., Gary, R.H., and Hunt, B.B., eds., Interconnection of the Trinity (Glend Rose) and Edwards aquifers along the Balcones Fault Zone and related topics: Karst Conservation Initiative, held February 17, 2011, p. 36-37.
- Klemt, W.B., Perkins, R.D., and Alvarez, H.J., 1975, Ground-water resources of part of Central Texas with emphasis on the Antlers and Travis Peak formations: Texas Water Development Board Report 195, v. 1, 63 p.
- Klemt, W.B., Knowles, T.R., Edler, G.R., and Sieh, T.W., 1979, Ground-water resources and model applications for the Edwards (Balcones fault zone) aquifer in the San Antonio region: Texas Water Development Board Report 239, 88 p.
- Knipe, R.J., 1997, Juxtaposition and seal diagrams to help analyze fault seals in hydrocarbon reservoirs: AAPG bulletin, v. 81, no.2, p.187-195.
- Kuniansky, E.L., 1989, Precipitation, streamflow, and base flow in west-central Texas, December 1974 through March 1977. Water-Resources Investigations Report 88-4218. 2 plates.

Conceptual Model Report for the Hill Country Trinity Aquifer
Groundwater Availability Model

- Kuniansky, E.L., 1990, Potentiometric surface of the Edwards-Trinity aquifer system and contiguous hydraulically connected units, west-central Texas, winter, 1974-75 (No. 89-4208). US Geological Survey.
- Kuniansky, E.L. and K.Q. Holligan. 1994. Simulations of flow in the Edwards-Trinity Aquifer system and contiguous hydraulically connected units, west-central Texas. U.S. Geological Survey. Water-Resources Investigations Report 93-4039. 40 p.
- Kuniansky, E. L., and Ardis, A. F., 2004, Hydrogeology and ground-water flow in the Edwards-Trinity aquifer system, west-central Texas: Regional aquifer-system analysis—Edwards-Trinity: U.S. Geological Survey Professional Paper 1421-C.
- Lang, L.W., 1953, Ground water in the Trinity Group in the San Antonio area, Texas: U.S. Geological Survey openfile report, 4 p.
- Langley, L., 1999, Updated evaluation of water resources in part of north-central Texas: Texas Water Development Board Report 349, 69 p.
- Larkin, T. J., and Bomar, G. W., 1983, Climatic Atlas of Texas: Texas Department of Water Resources, 151 p.
- Larsen, P.-H. 1988. Relay structures in a Lower Permian basement-involved extension system, East Greenland. *Journal of Structural Geology* 10, No, 1, 3-8.
- Laubach, S.E., and Jackson, M.L. 1990, Origin of arches in the northwestern Gulf of Mexico basin: *Geology*, v. 18, no. 7, p. 595–598, doi:10.1130/0091-7613(1990)018<0595:OOAITN>2.3.CO;2.
- LBG-Guyton Associates and NRS Consulting Engineers, 1995, Edwards/Glen Rose hydrologic communication: Prepared for the Edwards underground Water District, 121p.
- LBG-Guyton Associates and NRS Consulting Engineers, 2003, Brackish Groundwater Manual for Texas Regional Water Planning Groups: Prepared for the Texas Water Development Board, 188p.
- LBG-Guyton Associates, 2008, Groundwater Model for the Lower Trinity Aquifer in Bandera County, Texas and Surrounding Areas. Report prepared for Bandera County River Authority and Groundwater Conservation District. May 2008.
- Lindgren, R.J., Dutton, A.R., Hovorka, S.D., Worthington, S.R.H., and Painter, S., 2004, Conceptualization and simulation of the Edwards Aquifer, San Antonio region, Texas. Scientific Investigation Report 2004-5277. U.S. Geological Survey. 143 p.
- Livingston, P., 1947, Ground-Water Resources of Bexar County, Texas. Texas Board of Water Engineers Report.
- Long, A.T., 1958, Ground-water geology of Real County, Texas: Texas Board Water Engineers Bulletin 5803. 46 p.
- Long, A.T., 1962, Ground-water geology of Edwards County, Texas: Texas Water Commission. Bulletin 6208. 113 p.
- Long, A.T., 1963, Ground-water geology of Edwards County, Texas: U.S. Geological Survey Water-Supply Paper 1619-J. 29 p.

Conceptual Model Report for the Hill Country Trinity Aquifer
Groundwater Availability Model

- Loucks, R.G., 1977, Porosity development and distribution in shoal-water carbonate complexes—subsurface Pearsall Formation (Lower Cretaceous) South Texas, in Bebout, D.G., and Loucks, R.G., eds., *Cretaceous Carbonates of Texas and Mexico*: University of Texas at Austin, Bureau of Economic Geology, Report of Investigations no. 89, p. 97–126
- Lowry, R.L., 1955, Recharge to the Edwards ground-water reservoir. Consulting Engineer Report to the San Antonio City Water Board, San Antonio, Texas.
- Lowry, R.L., 1959, A Study of Droughts in Texas. Texas Board of Water Engineers Bulletin 5914. December, 1959.
- Lozo, F. E., and Stricklin, F.L., Jr., 1956, Stratigraphic notes on the outcrop basal Cretaceous, central Texas: Gulf Coast Association of Geological Societies Transactions, v. 6, p. 67-78.
- Lozo, F. E., and Smith, C.I., 1964, Revision of Comanche Cretaceous stratigraphic nomenclature, southern Edwards Plateau, Southwest Texas: Gulf Coast Association of Geological Societies Transactions, v. 14, p. 285–306.
- Mace, R.E., Chowdhury, A.H., Anaya, R., and Way, S.-C., 2000, Groundwater availability of the Trinity Aquifer, Hill County area, Texas—Numerical simulations through 2050: Texas Water Development Board Report 353, 117 p.
- Mace, R.E., 2001, Estimating Transmissivity Using Specific-Capacity Data. Bureau of Economic Geology Geological Circular 01-2. 2001.
- Maclay, R.W. and Small, T.A., 1983, Hydrostratigraphic subdivisions and fault barriers of the Edwards aquifer, south-central Texas, USA. *Journal of Hydrology*, v.61, no.1-3, p.127-146.
- Maclay, R.W., 1989, Edwards Aquifer in the San Antonio region: Its hydrogeology and management: *South Texas Geological Society Bulletin*, v.30, no. 4 ,p. 11-28.
- Maclay, R.W., and Land, L.F., 1988, Simulation of flow in the Edwards Aquifer, San Antonio Region, Texas, and refinement of storage flow concepts. U.S. Geological Survey Water-Supply Paper2336, 48 pp.
- Maclay, R.W., 1995, Geology and hydrology of the Edwards Aquifer in the San Antonio area, Texas (No. 95-4186). US Geological Survey.
- Manson, S., Schroeder, J., Van Riper, D., and Ruggles, S., 2017, *IPUMS National Historical Geographic Information System: Version 12.0* [Database]. Minneapolis: University of Minnesota. 2017. <http://doi.org/10.18128/D050.V12.0>, accessed March 2018.
- Mayer, J.R. and Sharp Jr, J.M., 1998. Fracture control of regional ground-water flow in a carbonate aquifer in a semi-arid region. *Geological Society of America Bulletin*, v. 110, no. 2, p.269-283.
- McGinnis, R. N., D. A. Ferrill, K. J. Smart, A. P. Morris, C. Higuera-Diaz, and D. Prawica, 2015, Pitfalls of using entrenched fracture relationships: Fractures in bedded carbonates of the Hidden Valley Fault Zone, Canyon Lake Gorge, Comal County, Texas: *American Association of Petroleum Geologists Bulletin*, v. 99, p. 2221–2245.
- Morris, A. P., D. A. Ferrill, and R. N. McGinnis, 2009a, Fault frequency and strain: *Lithosphere*, v. 1, no. 2, p. 105–109, doi:10.1130/L23.1.

Conceptual Model Report for the Hill Country Trinity Aquifer
Groundwater Availability Model

- Morris, A. P., D. A. Ferrill, and R. N. McGinnis, 2009b, Mechanical stratigraphy and faulting in Cretaceous carbonates: AAPG Bulletin, v. 93, no. 11, p. 1459–1470, doi:10.1306/04080909011.
- Morris, A.P., McGinnis, R.N. and Ferrill, D., 2014, Fault displacement gradients on normal faults and associated deformation. AAPG bulletin, v.98, no.6, p.1161-1184.
- Muller, D.A. and McCoy, W., 1987, Ground-water conditions of the Trinity Group aquifer in western Hays County: Texas Water Development Board LP-205, 62 p.
- Muller, D.A., 1990, Ground-water evaluation in and adjacent to Dripping Springs, Texas, Texas Water Development Board, Report 322, 59 p.
- Murray, G.E., 1956, Relationships of Paleozoic structures to large anomalies of coastal element of eastern North America: Gulf Coast Association of Geological Societies Transactions, v. 6, p. 13-24.
- Murray, G.E., 1961, Geology of the Atlantic and Gulf Coastal Province of North America: New York, Harper and Brothers, 692 pp.
- Musgrove, M., Fahlquist, L., Houston, N.A., Lindgren, R.J. and Ging, P.B., 2010, Geochemical evolution processes and water-quality observations based on results of the National Water-Quality Assessment Program in the San Antonio segment of the Edwards aquifer, 1996-2006. U. S. Geological Survey. Accessed July 11, 2017, 93 p.
- Musgrove, M., and Crow, C.L., 2012, Origin and characteristics of discharge at San Marcos Springs based on hydrologic and geochemical data (2008–10), Bexar, Comal, and Hays Counties, Texas: U.S. Geological Survey Scientific Investigations Report 2012–5126, 94 p.
- Myers B.N., 1969, Compilation of results of Aquifer Tests in Texas, Texas Water Development Board Report 98, p. 532.
- National Water Quality Monitoring Council (NWQMC), 2017, Water Quality Portal, database accessed 2017.
- Nordstrom, P.L., 1982, Occurrence, availability, and chemical quality of ground water in the Cretaceous aquifers of north-central Texas: Texas Department of Water Resources Report 269, v. 1, 109 p., and v. 2, 387 p. obtained in electronic form: <http://www.twdb.texas.gov/>
- Nordstrom, P.L., 1987, Ground-water resources of the Antlers and Travis Peak formations in the outcrop area of north-central Texas: Texas Department of Water Resources Report 298, 297 p. obtained in electronic form: http://www.twdb.texas.gov/publications/reports/numbered_reports/doc/R298/report298.asp.
- Oliver, W. and J. Pinkard, 2018, Recalibration and Predictive Simulations of the Analytic Element Tool to Evaluate the Trinity Aquifer in Hays County, Texas. Technical Memorandum to the BSEACD. April 16, 2018. 29 p.
- Peacock, D.C.P., Sanderson, D.J., 1991. Displacements, segment linkage, and relay ramps in normal fault zones. Journal of Structural Geology 13, 721–733.
- Peacock, D.C.P., Sanderson, D.J., 1994. Geometry and development of relay ramps in normal fault systems. American Association of Petroleum Geologists Bulletin 78, 147–165.

Conceptual Model Report for the Hill Country Trinity Aquifer
Groundwater Availability Model

- Phelps, R. M., Kerans, C., Loucks, R.G., Scott, R.W., Da Gama, B.P., Jeremiah, J., and Hull, D., 2014, Oceanographic and eustatic control of carbonate platform evolution and sequence stratigraphy on the Cretaceous (Valanginian-Campanian) passive margin, northern Gulf of Mexico: *Sedimentology*, v. 61, p. 461–496.
- Phelps, R.M., 2011, Middle-Hauterivian to Lower Campanian sequence stratigraphy and stable isotope geochemistry of the Comanche Platform, south Texas. PhD Dissertation, University of Texas, Austin, TX. 227 pp.
- PRISM Climate Group, 2016, Prism Temperature Data Raster Map: Oregon State University, <http://prism.oregonstate.edu>.
- Puente, C., 1978. Method of estimating natural recharge to the Edwards Aquifer in the San Antonio area, Texas. U.S. Geological Survey Water Resources Investigations 78-10. 34 p.
- Ramsay, J.G., Huber, M., 1987. *The Techniques of Modern Structural Geology, Volume 2: Folds and Fractures*. Academic Press, London.
- Reeves, R.D., 1967, Ground-water resources of Kendall County, Texas Water Development Board. Report 60, 64 p.
- Reeves, R.D., 1969, Ground-water resources of Kerr County, Texas Water Development Board. Report 102, 59 p.
- Reeves, R. D. and Small, T.A., 1973, Ground-Water Resources of Val Verde County, Texas, Texas Water Development Board, Report 172. June 1973
- Ridgeway, C., and Petrini, H., 1999, Changes in groundwater conditions in the Edwards and Trinity aquifers, 1987–1997, for portions of Bastrop, Bell, Burnet, Lee, Milam, Travis and Williamson counties, Texas: Texas Water Development Board Report 350, 38 p.
http://www.twdb.texas.gov/publications/reports/numbered_reports/doc/R350/Report350.asp.
- Rose, P.R., 1972, Edwards Group, Surface and Subsurface, Central Texas: The University of Texas at Austin, Bureau of Economic Geology Report of Investigations No. 74, 198 p. 35 figs, 19 plates.
- Rose, P. R., 1986a, Pipeline oil spills and the Edwards aquifers, Central Texas, in P. L. Abbott and C. M. Woodruff, Jr., eds., *The Balcones Escarpment: Geology, hydrology, ecology and social development in Central Texas*: Geological Society of America, Boulder, Colorado, p. 163–183.
- Rose, P. R., 1986b, Oil and gas occurrence in Lower Cretaceous rocks, Maverick Basin area, Southwest Texas, in W. L. Stapp, ed., *Contributions to the geology of South Texas*: South Texas Geological Society, San Antonio, p. 408–421.
- Rose, P.R., 2016a, Late Cretaceous and Tertiary burial history, central Texas: *GCAGS Journal*, v. 5, p. 141–179.
- Rose, P.R., 2016b, Regional Stratigraphy of the Edwards Group and Associated Formations of Texas (Lower Cretaceous, Comanchean): In Defense of the Classical View: *GCAGS Journal*, v. 6, p. 111–134.
- Sandidge, J. R., 1959, A review of Edwards Limestone production with special reference to south-central Texas, in F. E. Lozo, H. F. Nelson, K. Young, O. B. Shelburne, and J. R.

Conceptual Model Report for the Hill Country Trinity Aquifer
Groundwater Availability Model

- Sandidge, eds., Symposium on Edwards Limestone in central Texas: The University of Texas Publication 5905, p. 131–151.
- Schindel, G., and Johnson, S., 2011, Using tracer testing data for resource management planning. In *Interconnection of the Trinity (Glen Rose) and Edwards Aquifers along the Balcones Fault Zone and Related Topics*, Proceedings from Karst Conservation Initiative Meeting, February 17, 38. http://www.speleogenesis.info/directory/karstbase/pdf/seka_pdf9869.pdf.
- Scott, R. W. (ed.), 2007, *Cretaceous Rudists and Carbonate Platforms: Environmental Feedback*, SEPM Special Publication No. 87. Tulsa, Oklahoma.
- Scott, R. W. and Filkorn, H. F. 2007. Barremian–Albian rudist zones, U.S. Gulf Coast. in R. W. Scott, ed., *Cretaceous Rudists and Carbonate Platforms: Environmental Feedback*. SEPM Special Publication, 87, 167–180.
- Schultz, A.L., 1992, Using geophysical logs in the Edwards Aquifer to estimate water quality along the freshwater/saline-water interface (Uvalde to San Antonio, Texas): San Antonio. Texas, Edwards Underground Water District Report, p.92-03.
- Sharp Jr, J.M. and Banner, J.L., 1997. The Edwards Aquifer: A resource in conflict. *GSA Today*, v. 7, no. 8, p. 1-9.
- Slade, R.M., Bentley, J.T., and Michaud, D., 2002, Results of streamflow gain-loss studies in Texas, with emphasis on gains from and losses to major and minor aquifers. U.S. Geological Survey Open-File Report 02–06, p. 136.
- Slattery, R.N., A.L. Furlow, and D.J. Ockerman, 2006, Hydrologic and Water-Quality Data, Honey Creek State Natural Area, Comal County, Texas, August 2001–September 2003. US Geological Survey Data Series 200.
- Small, T., 1986, Hydrologic sections of the Edwards Aquifer and its confining unites in the San Antonio area, Texas, U.S. Geological Survey Water-Resources Investigations Report 85-4259, p. 46.
- Smith, B.A. and Hunt, B.B., 2009, Potential hydraulic connections between the Edwards and Trinity aquifers in the Balcones Fault Zone of central Texas: *Bulletin of the South Texas Geological Society*, Volume L, Issue No. 2, October 2009, p. 15-34.
- Smith, B.A., and Hunt, B.B., 2010, Flow potential between stacked Karst Aquifers in Central Texas, USA. In *Advances in Research in Karst Media Environmental Earth Sciences*, eds. B. Andreo, F. Carrasco, J.J. Duran, and J.W. LaMoreaux. p. 43–48.
- Smith, B.A., and Hunt, B.B., 2011, Potential for vertical flow between the Edwards and Trinity Aquifer, Barton Springs Segment of the Edwards Aquifer. In *Interconnection of the Trinity (Glen Rose) and Edwards Aquifers along the Balcones Fault Zone and Related Topics*, *Proceedings from Karst Conservation Initiative Meeting*. p.11–14.
- Smith, C. I., Brown, J. B., and Lozo, F. E., 2000, Regional stratigraphic cross sections, Comanche Cretaceous (Fredericksburg-Washita division), Edwards and Stockton Plateaus, West Texas: The University of Texas at Austin, Bureau of Economic Geology, 39 p., 6 plates.

Conceptual Model Report for the Hill Country Trinity Aquifer
Groundwater Availability Model

- Stricklin, F. L., Jr., Smith, C. I., and Lozo, F. E., 1971, Stratigraphy of Lower Cretaceous Trinity deposits of Central Texas: The University of Texas at Austin, Bureau of Economic Geology Report of Investigations No. 71, 63 p.
- Stricklin, F.L. and Smith, C.I., 1973, Environmental Reconstruction of a Carbonate Beach Complex: Cow Creek (Lower Cretaceous) Formation of Central Texas: Geological Society of America Bulletin, v. 84. Rose, P. R., 1972, Edwards Group, Surface and Subsurface, Central Texas: The University of Texas at Austin, Bureau of Economic Geology Report of Investigations No. 74, 198 p.
- Stricklin, F. L., Jr., and Amsbury, D.L., 1974, Depositional environments on a low-relief carbonate shelf, middle Glen Rose Limestone, central Texas, in B. F. Perkins, ed., Geoscience and Man, v. VIII: Louisiana State University Press, Baton Rouge, p. 53-66.
- Sundstrom, R.W., Broadhurst, W.L., and Dwyer, B.C., 1949, Public Water Supplies in Central and North-Central Texas, Geological Survey Water-Supply Paper 1069: Prepared in cooperation with the Texas Board of Water Engineers.
- Texas A&M University (TAMU), 2018, Soil & Water Assessment Tool, Baseflow Filter Program. Website: <https://swat.tamu.edu/software/baseflow-filter-program/>, accessed 2018.
- Texas Commission on Environmental Quality, 2015, TCEQ Public Water Supply well data: personal communication from Sean Ables (TCEQ) to Steve Young (INTERA Incorporated) via email March 2015.
- Texas Natural Resources Information System (TNRIS), 1997, database accessed November, 2018.
- Texas Water Development Board, 2017a, Brackish Resources Aquifer Characterization System (BRACS) Database: website <http://www.twdb.texas.gov/innovativewater/bracs/database.asp>, accessed September 2017.
- Texas Water Development Board, 2017b, Groundwater database download: website <http://www.twdb.texas.gov/groundwater/data/gwdb rpt.asp>, accessed September 2017.
- Texas Water Development Board, 2017d, Submitted drillers' reports database download: website <http://www.twdb.texas.gov/groundwater/data/drillersdb.asp>, accessed September 2017.
- Texas Water Development Board, 2017e, Water use survey data: personal communication from Bill Billingsley (TWDB) to Jevon Harding (INTERA Incorporated) via email dated October 4, 2017.
- Texas Water Development Board, 2018a, Historical Groundwater Pumpage: website <http://www.twdb.texas.gov/waterplanning/waterusesurvey/historical-pumpage.asp> accessed February 2018.
- Texas Water Development Board, 2018b, Historical Surveyed Municipal and Industrial Water Intake: website <http://www.twdb.texas.gov/waterplanning/waterusesurvey/estimates/index.asp>, accessed February 2018.

Conceptual Model Report for the Hill Country Trinity Aquifer
Groundwater Availability Model

- Theis, C.V., Brown, R.H., and Myers, R.R., 1963, Estimating the transmissibility of aquifers from the specific capacity of wells: methods of determining permeability, transmissivity, and drawdown, in U.S. Geological Survey Water-Supply Paper, 1536-1, p. 331-341.
- Tremallo, R.L., J.M. Hamilton, S. Johnson, R. Esquilin, C. Burgoon, D. Gregory, G. Luevano, M. Schwarz, T. Marsalia, J. Mireles, R. Gloyd, and G. Schindel, 2014. Edwards Aquifer Authority Hydrologic Data Report for 2013. 86 p.
- Trudgill, B., Cartwright, J., 1994. Relay-ramp forms and normal-fault linkages, Canyonlands National Park, Utah. Geological Society of America Bulletin 106, 1143–1157.
- Tucker, D.R., 1962, Subsurface lower Cretaceous stratigraphy, central Texas. PhD Dissertation, University of Texas. 167 p.
- United States Department of Agriculture, 2018, Natural Resources Conservation Service, U.S. General Soil Map (STATSGO2). Available online at <https://websoilsurvey.nrcs.usda.gov/>. Accessed 4/2/2018.
- U.S. Environmental Protection Agency (USEPA) and U.S. Geological Survey (USGS), 2012. National Hydrography Dataset Plus – NHDPlus 2.10 geospatial data. Website: http://www.horizon-systems.com/NHDPlus/NHDPlusV2_home.php.
- U.S. Geological Survey, 2002, Physiographic divisions of the conterminous U.S.: website <http://water.usgs.gov/GIS/metadata/usgswrd/XML/physio.xml#stdorder>, accessed 2017.
- U.S. Geological Survey, 2017. National water information system database: website <https://waterdata.usgs.gov/nwis>, accessed September 2017.
- U.S. Geological Survey, 2018. National water information system database: website <https://waterdata.usgs.gov/nwis>, accessed November, 2018.
- Vogelmann, J.E., Howard, S.M., Yang, L., Larson, C.R., Wylie, B.K., and Van Driel, J.N., 2001, [Completion of the 1990's National Land Cover Data Set for the conterminous United States](#), *Photogrammetric Engineering and Remote Sensing* 67:650-662.
- Walker, L.E., 1979, Occurrence, Availability, and Chemical Quality of Ground Water in the Edwards Plateau Region of Texas, TWDB Report 235.
- Ward, W. C., and Ward, W.B., 2007, Stratigraphy of the middle part of Glen Rose Formation (Lower Albian), Canyon Lake Gorge, central Texas, in R. W. Scott, ed., Cretaceous rudists and carbonate platforms: Environmental feedback: SEPM Special Publication 87, p. 193–210.
- W.E. Simpson Company and William F. Guyton Associates, 1993, North Bexar County Water Resources Study for the Edwards Underground Water District, September 1993.
- Weeks, A.W., 1945, Balcones, Luling, and Mexica fault zones in Texas: Bulletin of the American Association of Petroleum Geologists, v. 29, p. 1733–1737.
- Welder, F.A., and Reeves, R.D., 1964, Geology and groundwater resources of Uvalde County, Texas: Water Supply Paper 1584, 49p.
- Wermund, E. G., 1996, Physiography of Texas: The University of Texas at Austin, Bureau of Economic Geology, 2 p.

Conceptual Model Report for the Hill Country Trinity Aquifer
Groundwater Availability Model

- Wierman, D.A., Broun, A.S., and Hunt, B.B. 2010, Hydrogeologic Atlas of the Hill Country Trinity Aquifer Blanco, Hays, and Travis Counties, Central Texas.
- Winter, J. A., 1961, Stratigraphy of the Lower Cretaceous (subsurface) of South Texas: Gulf Coast Association of Geological Societies Transactions, v. 11, p. 15–24.
- Wong, C.I., Kromann, J.S., Hunt, B.B., Smith, B.A., and Banner, J.L., 2014, Investigating Groundwater Flow Between Edwards and Trinity Aquifers in Central Texas. Groundwater. Volume 52, Number 4, July-August 2014. Pp 624–639.
- Yielding, G., Freeman, B. and Needham, D.T., 1997, Quantitative fault seal prediction: AAPG bulletin, v. 81, no.6, p.897-917.
- Young, K., 1972, Mesozoic history, Llano region: in Barnes, V. E., Bell, W. C., Clabaugh, S. E., and Cloud, P. E., eds., Geology of the Llano region and Austin area, field excursion, The University of Texas at Austin, Bureau of Economic Geology Guidebook 13, 77 p.
- Young, S.C., Budge, T., and Snyder, G., 2005. Development and Application of a Groundwater Model for North Medina County. Report prepared for: Medina County Groundwater Conservation District, April 2005.
- Young, S.C., Doherty, J., Budge, T., and Deeds, N., 2010, Application of PEST to Re-Calibrate the Groundwater Availability Model for the Edwards-Trinity (Plateau) and Pecos Valley Aquifers. Report prepared for the Texas Water Development Board, April 2010.
- Zahm, C.K., Marrett, R. and Sharp Jr, J.M., 1998, Prediction of regional groundwater flow and permeability anisotropy using fractured outcrop exposures, Edwards aquifer, central Texas. In *Proceedings of the Joint Meeting of the 28th Congress of the International Association of Hydrogeologists and the Annual Meeting of the American Institute of Hydrologists*, v. 28, p. 697-705.
- Zahm, C., Zahm, L., and Bellian, J.A., 2010, Integrated fracture prediction using sequence stratigraphy within a carbonate fault damage zone, Texas, USA: *Journal of Structural Geology*, v. 32, no. 9, p. 1363–1374, doi:10.1016/j.jsg .2009.05.012.

Edwards Hydrographs

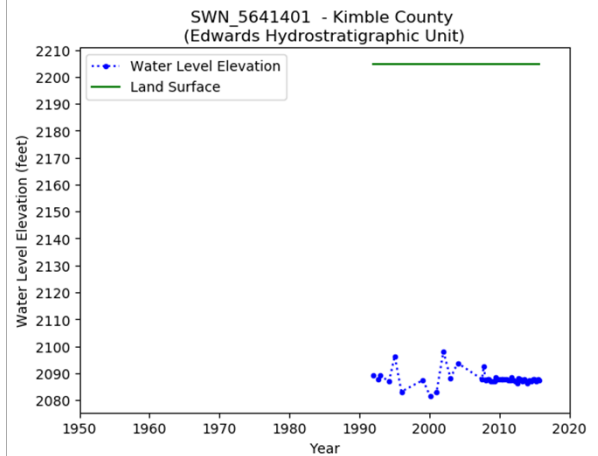
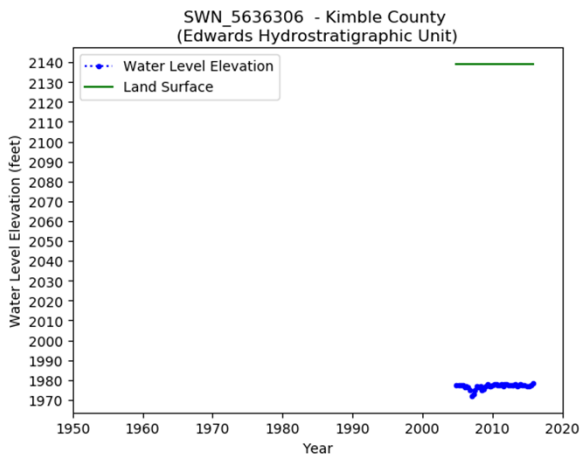
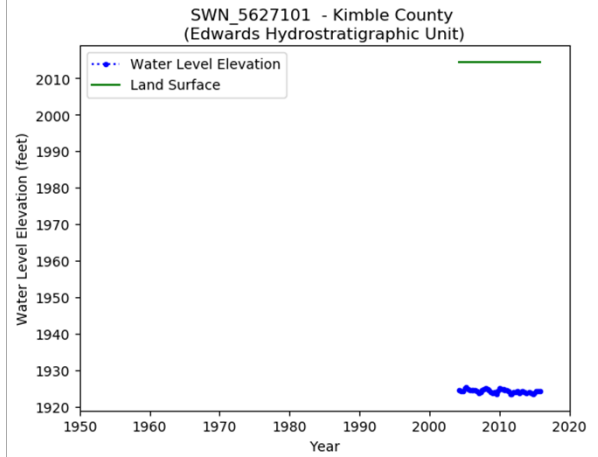
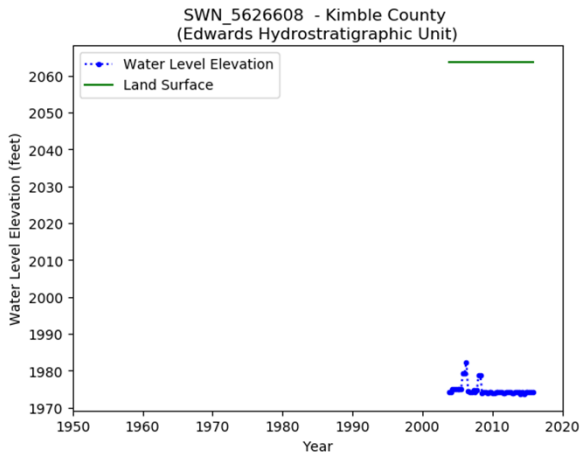
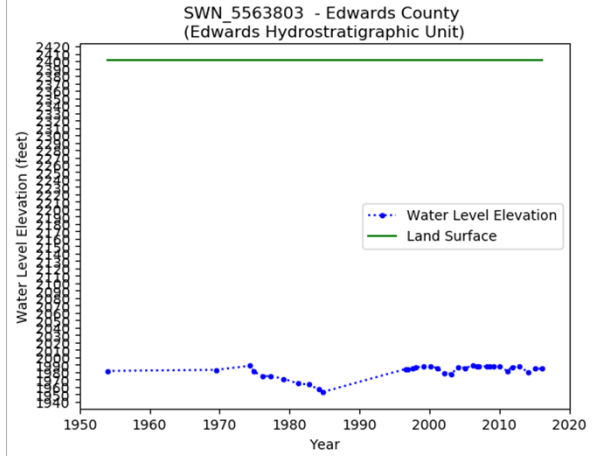
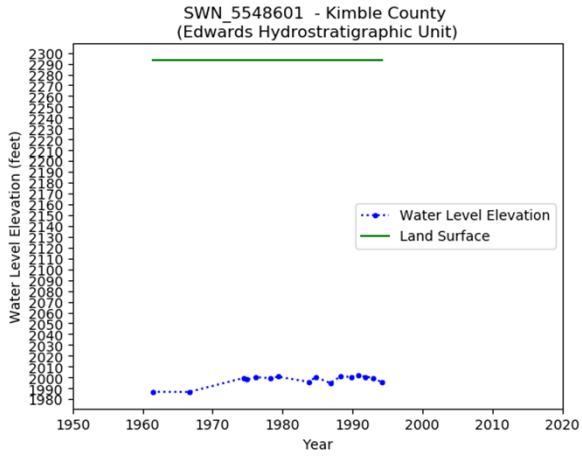

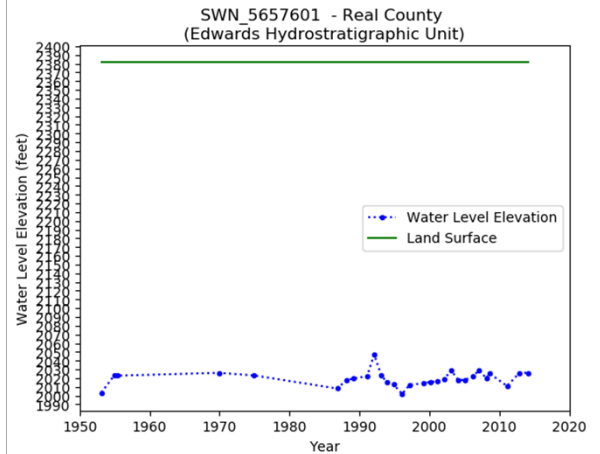
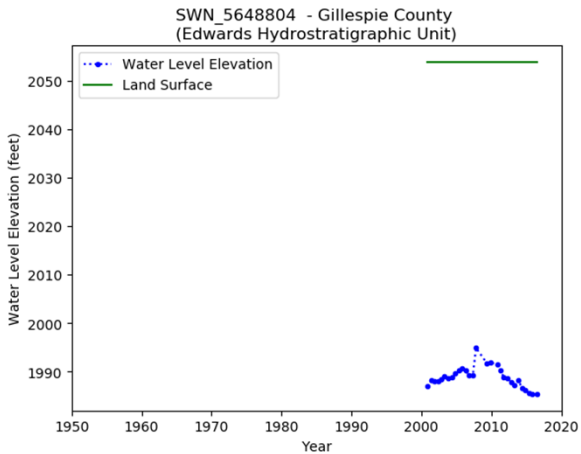
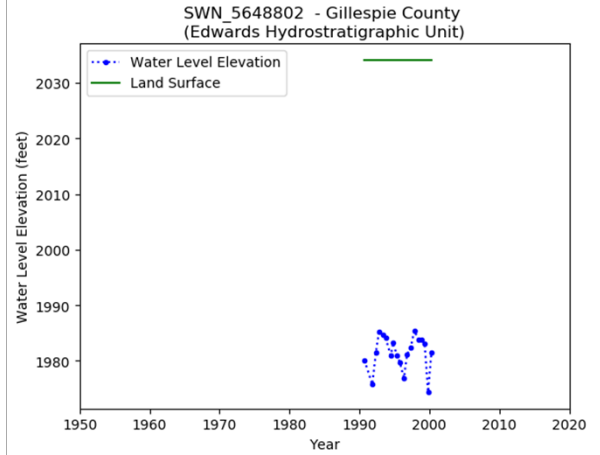
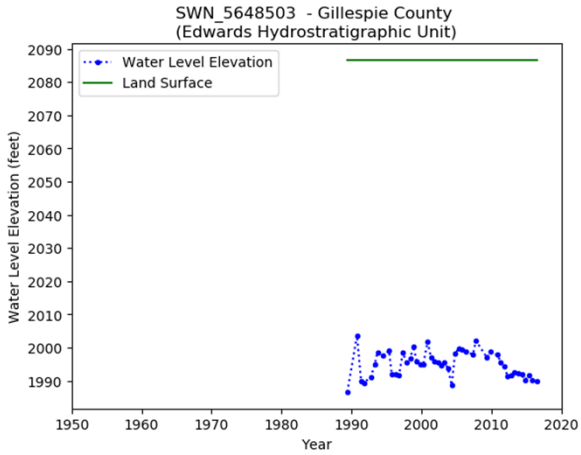
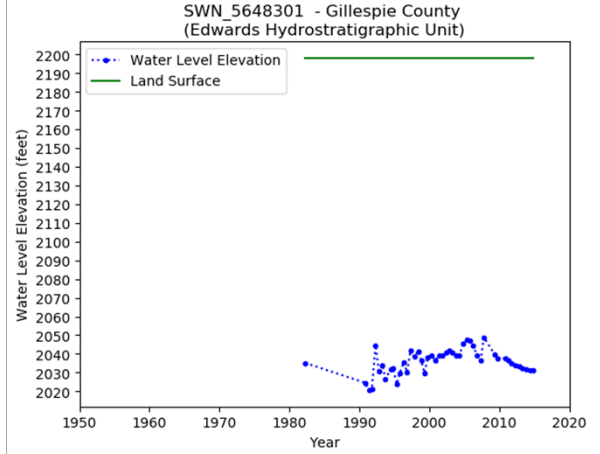
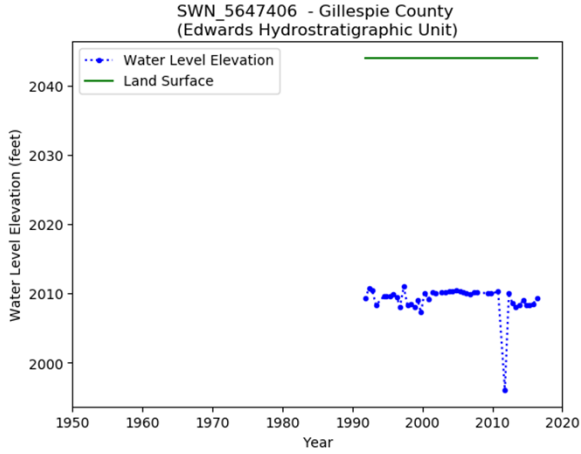

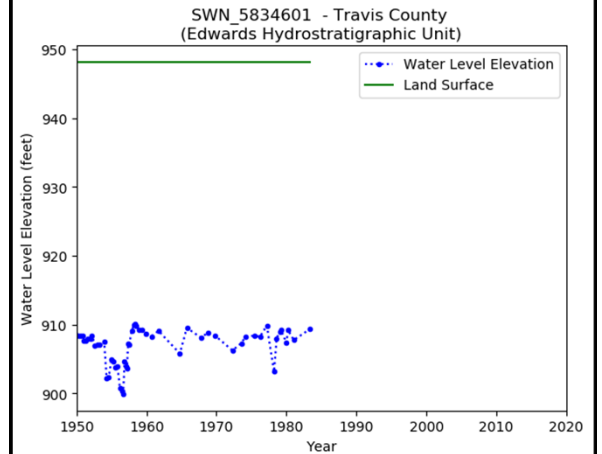
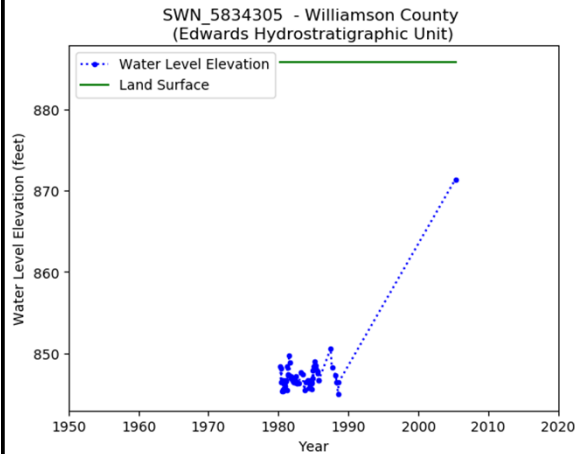
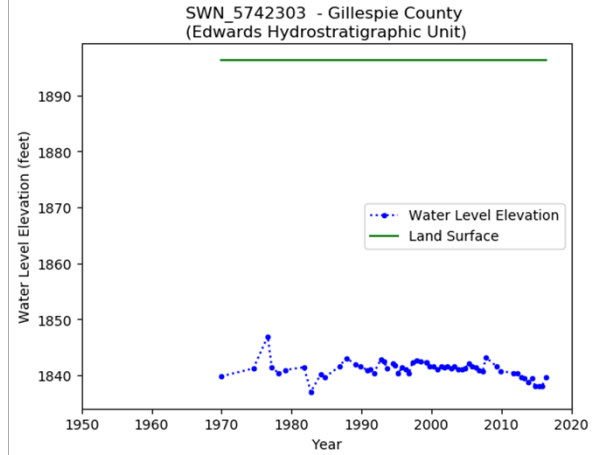
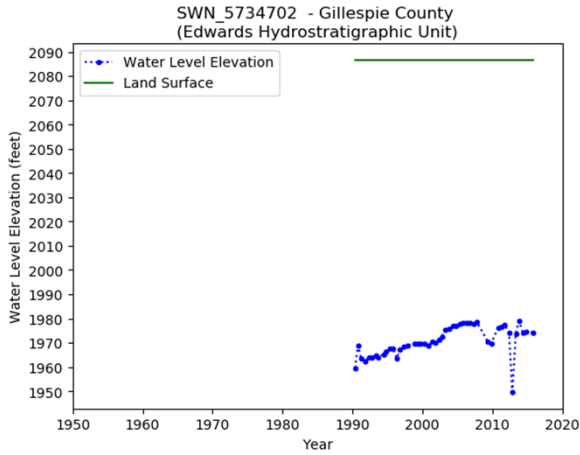
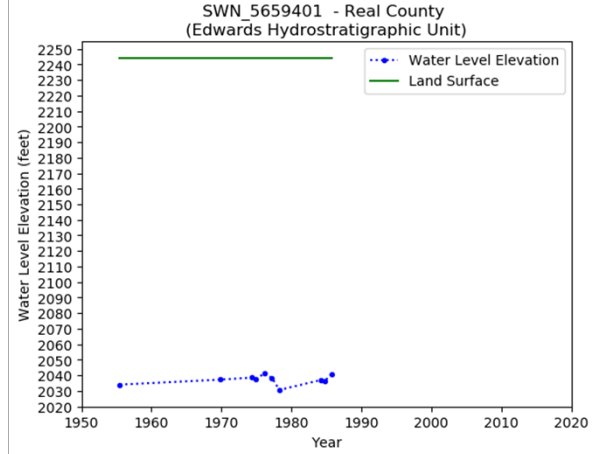
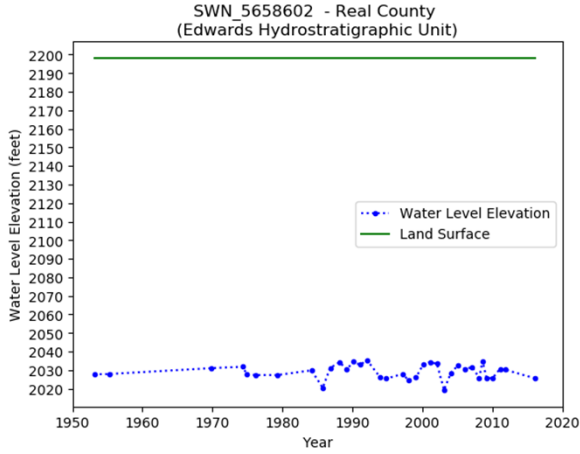

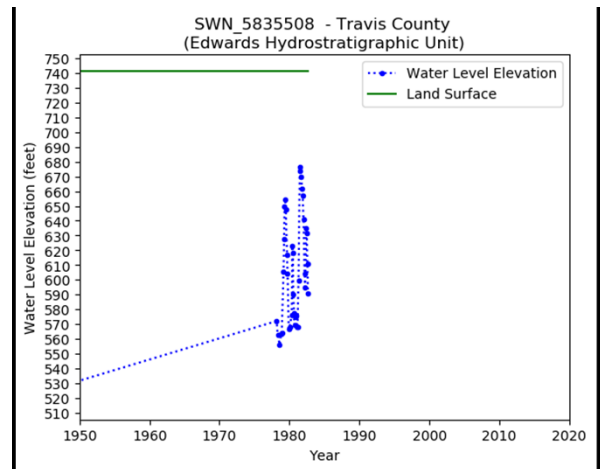
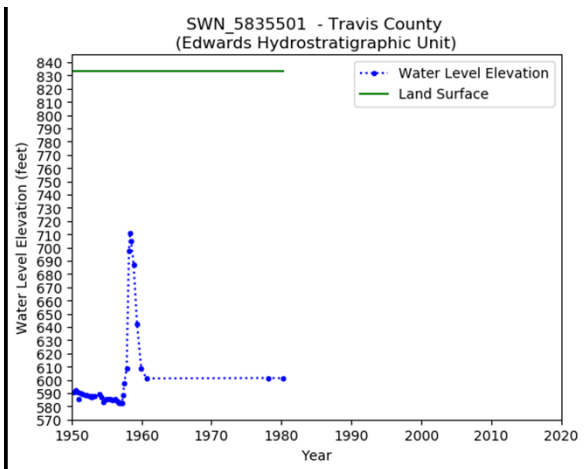
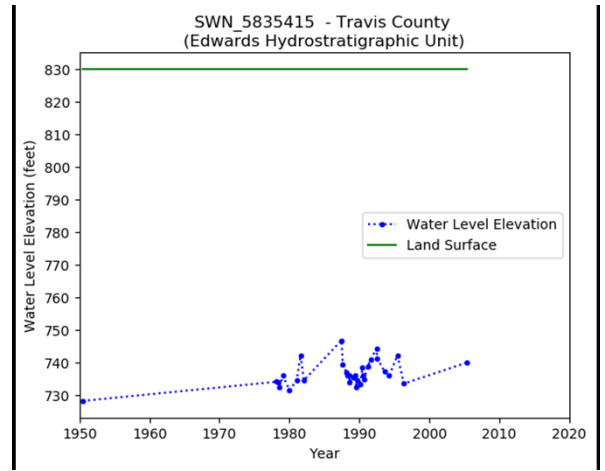
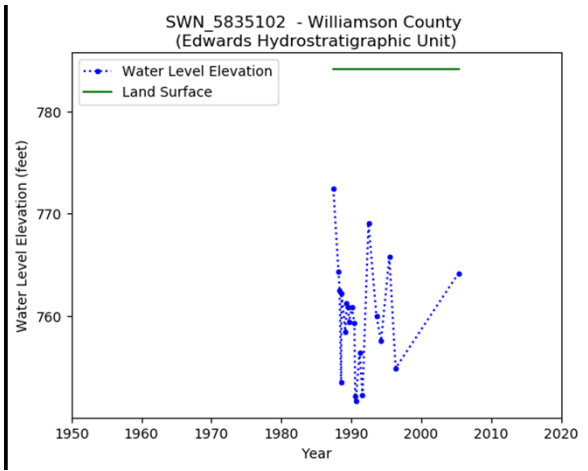
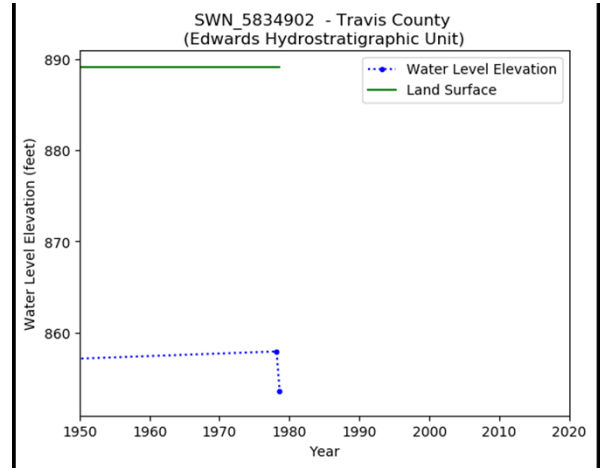
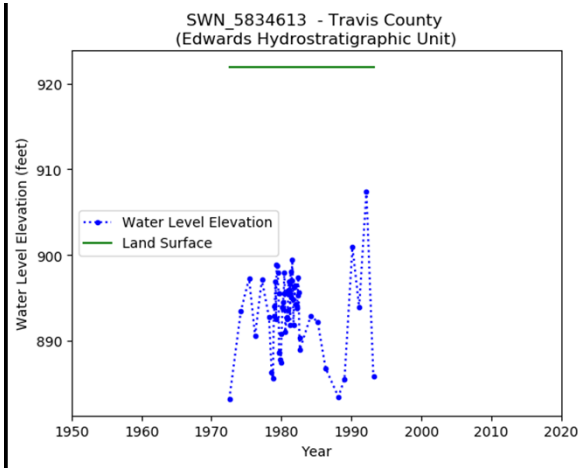

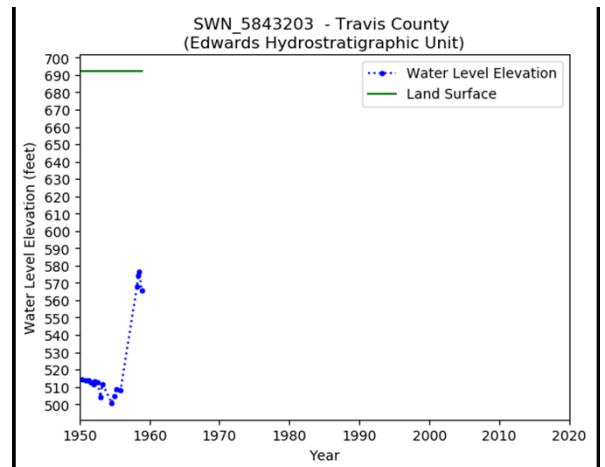
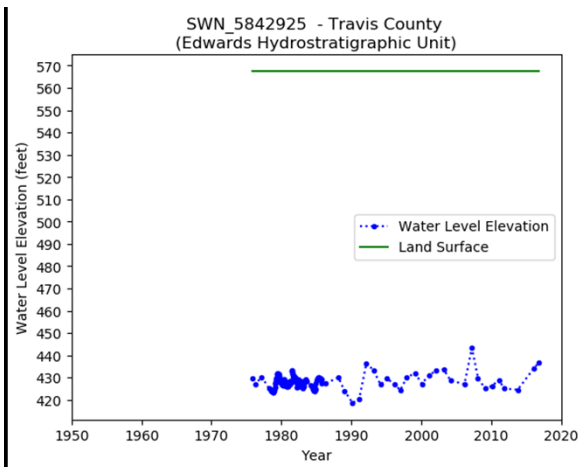
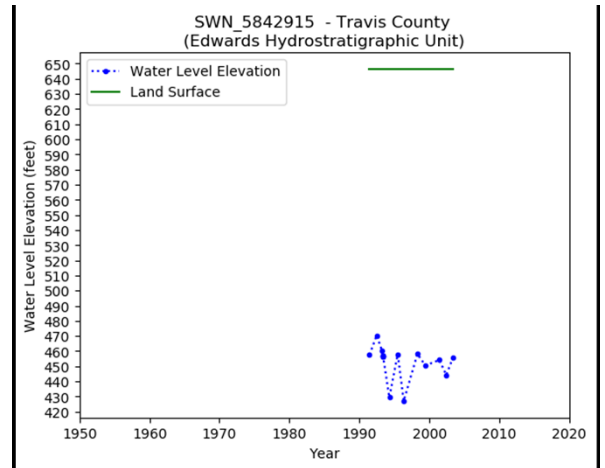
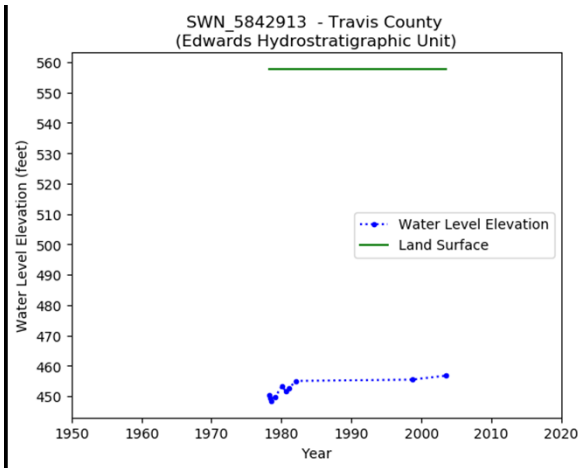
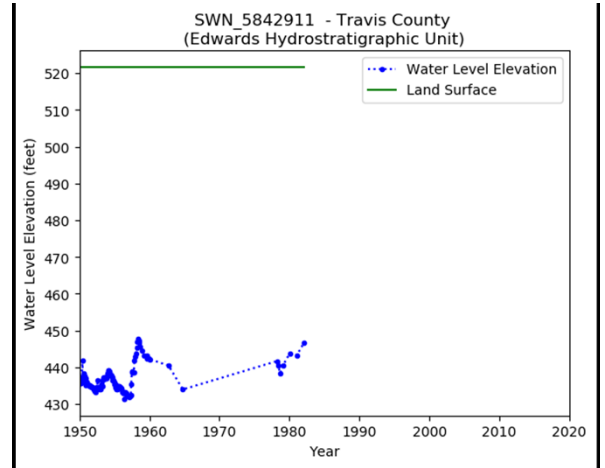
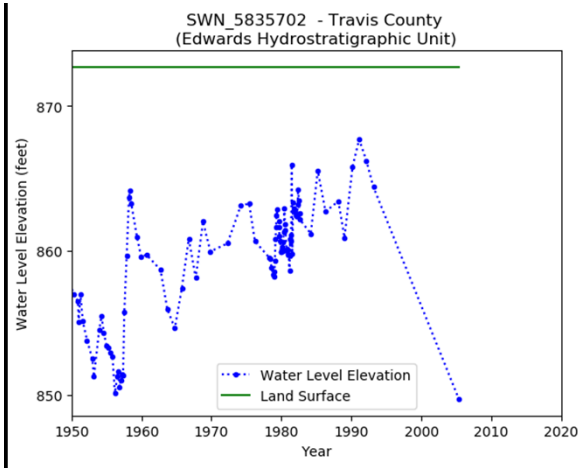

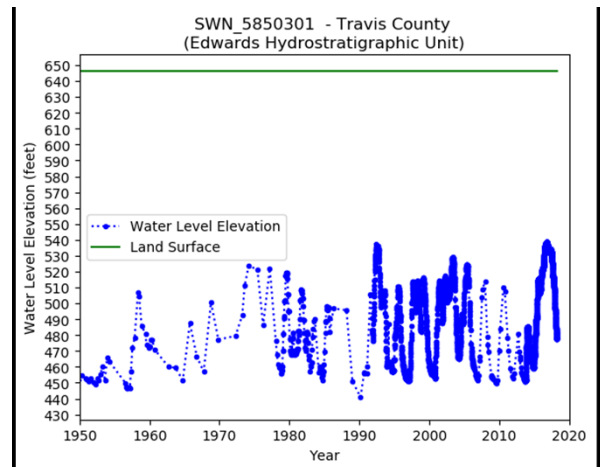
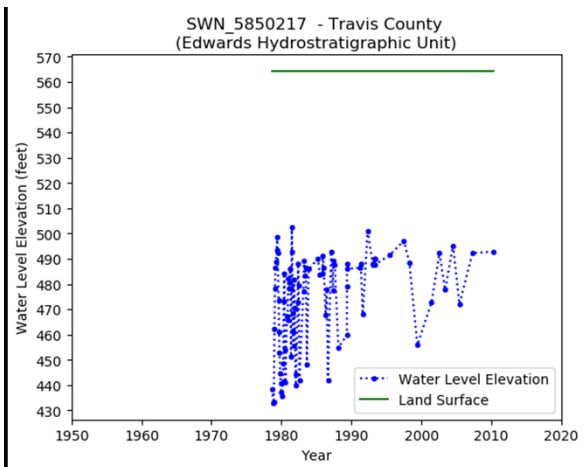
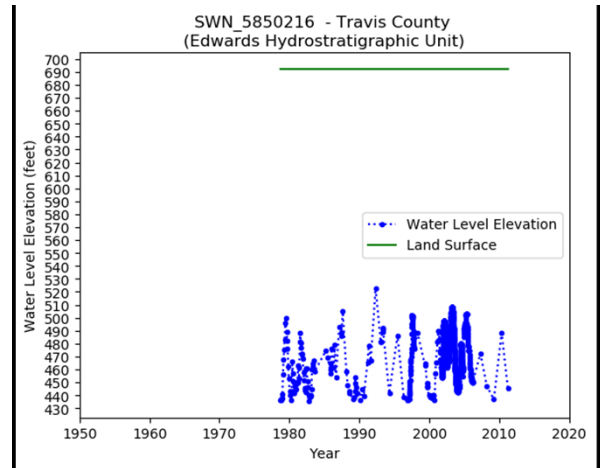
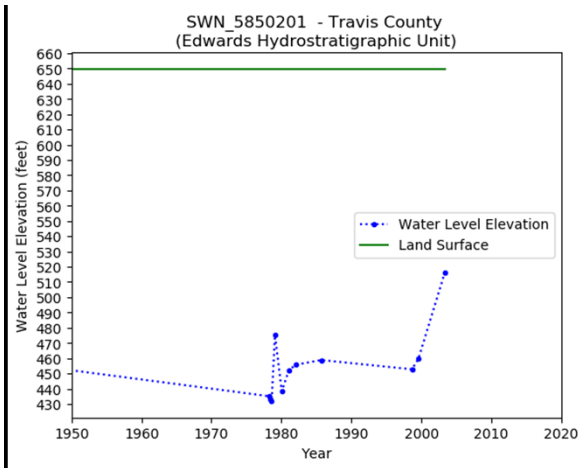
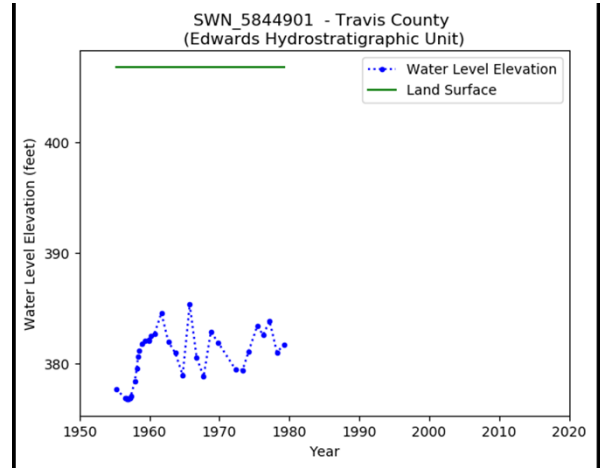
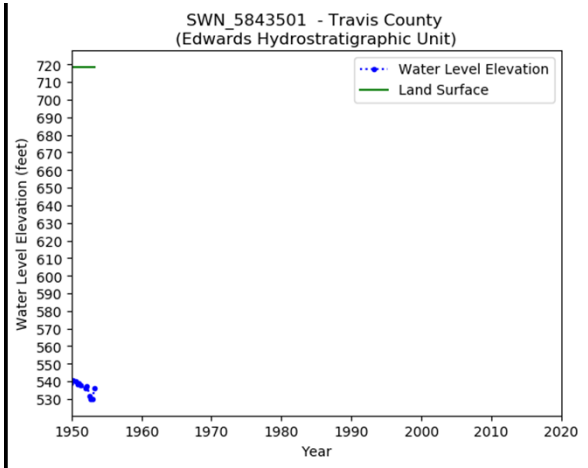

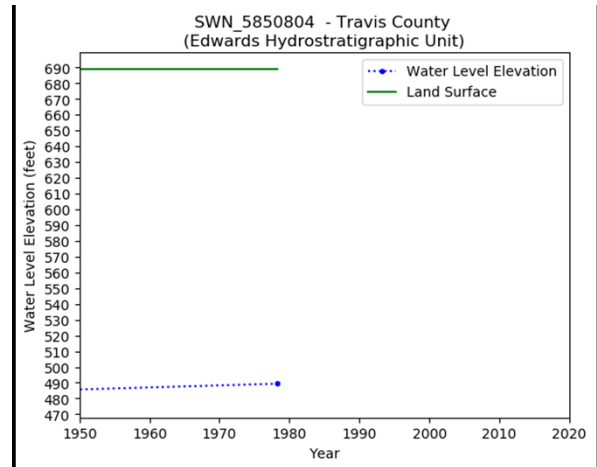
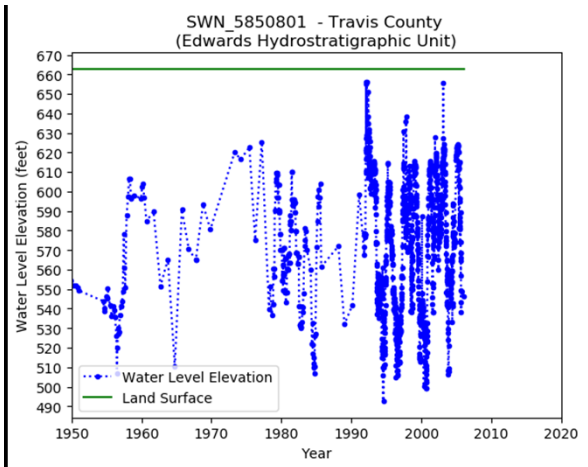
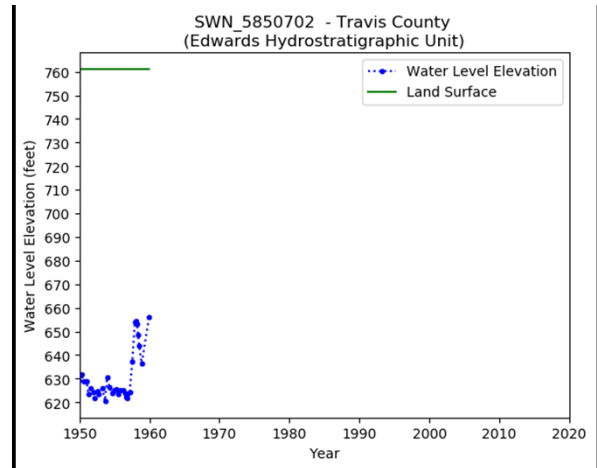
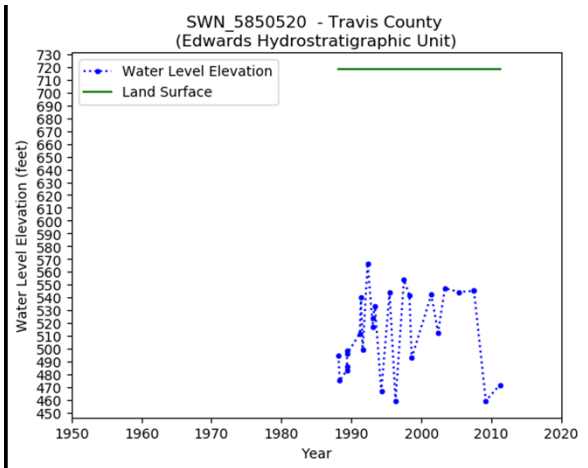
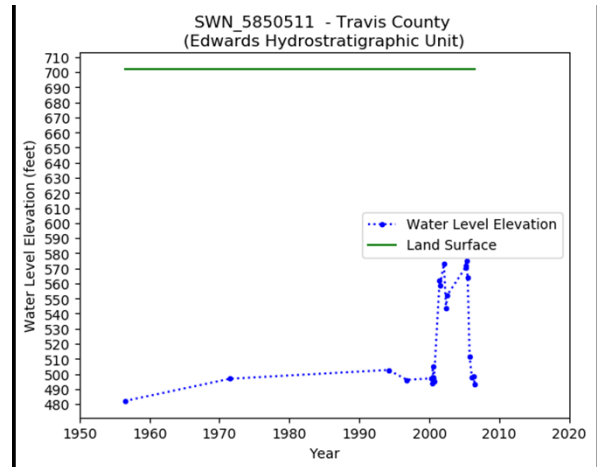
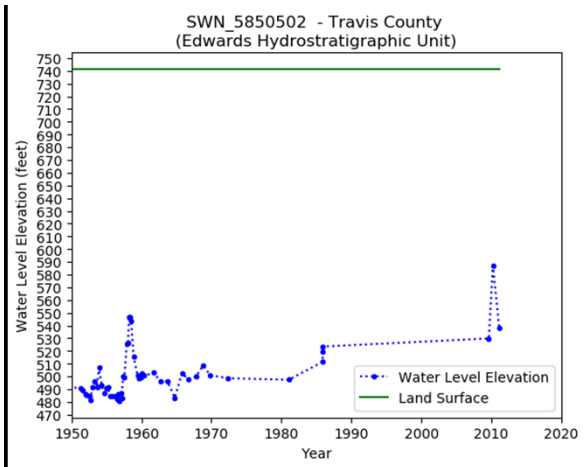

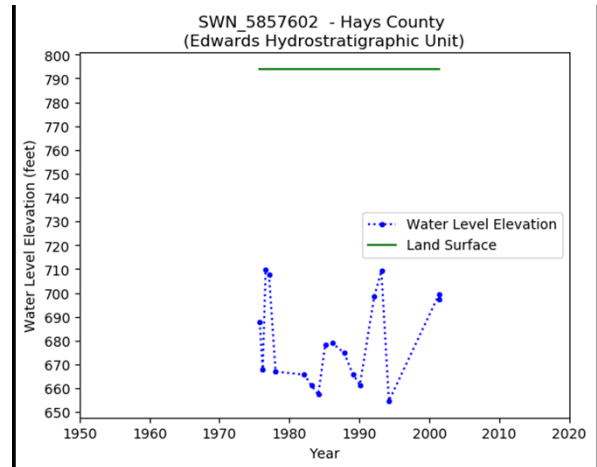
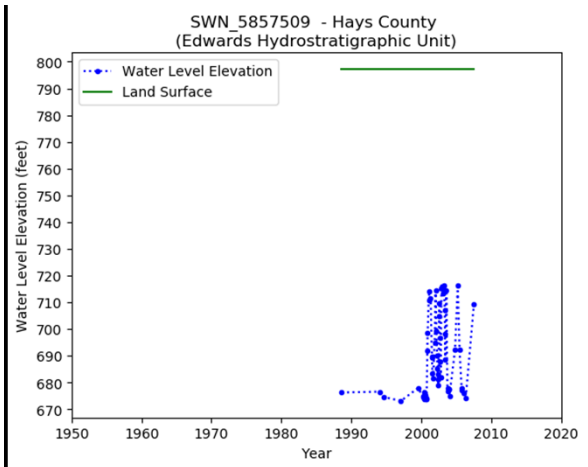
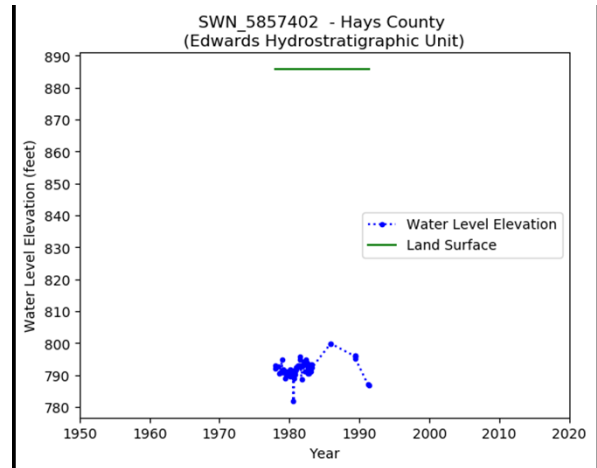
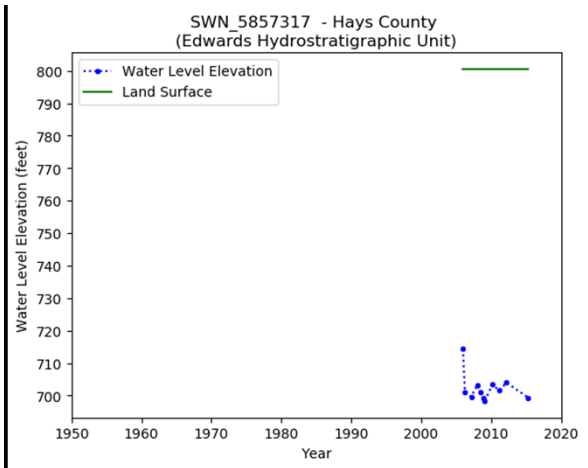
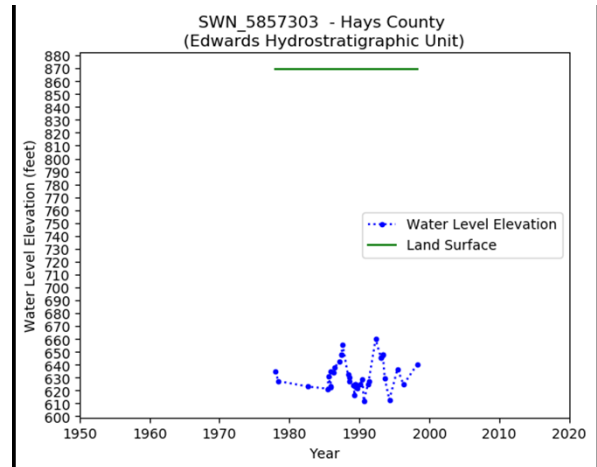
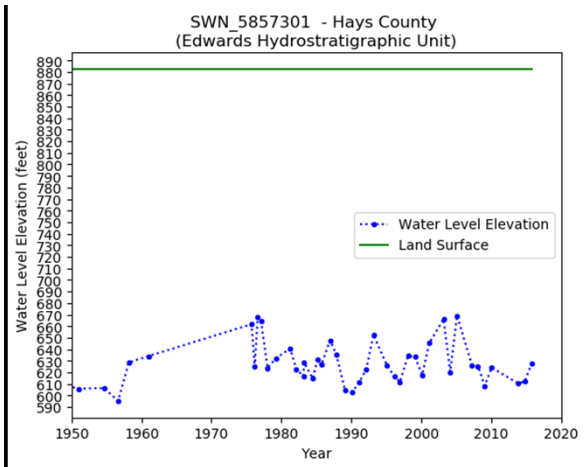

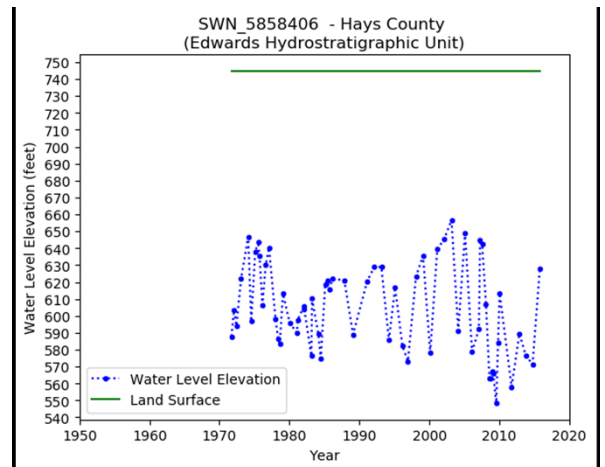
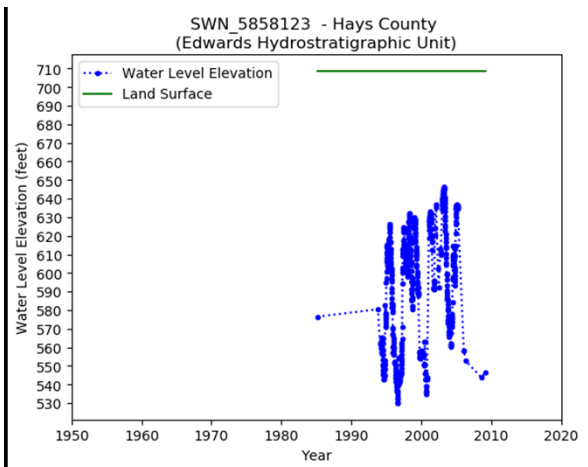
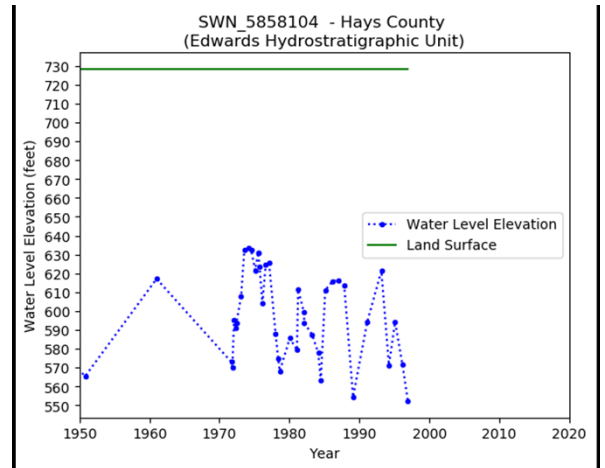
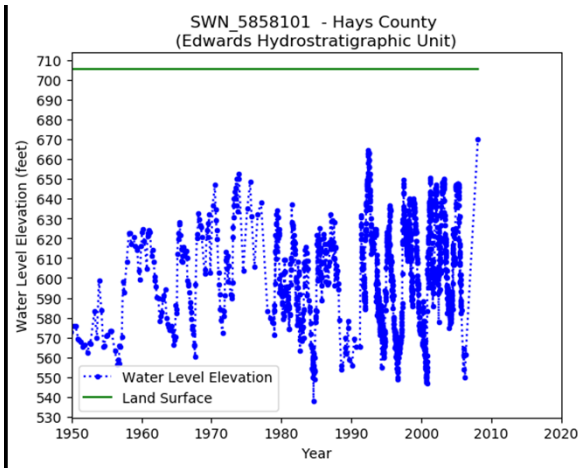
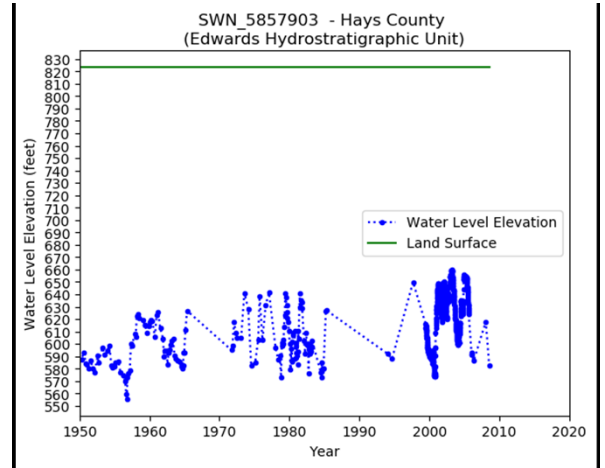
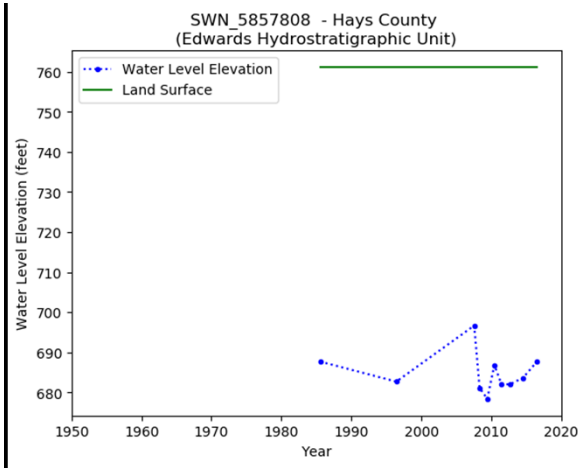

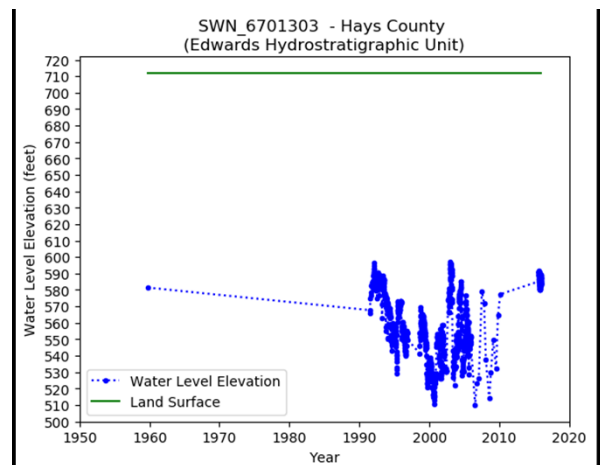
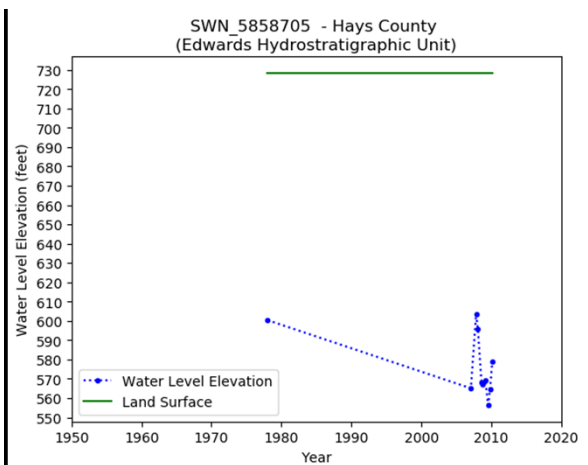
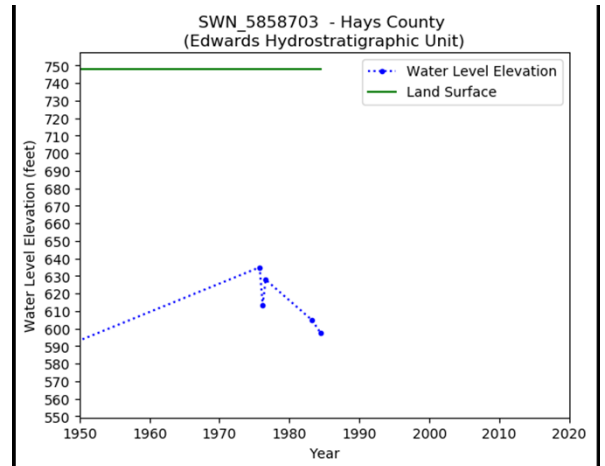
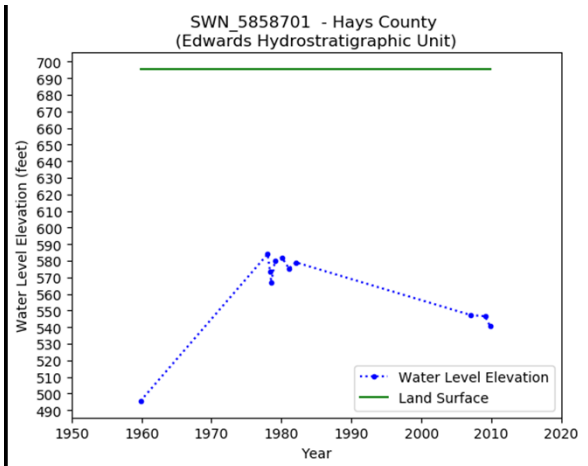
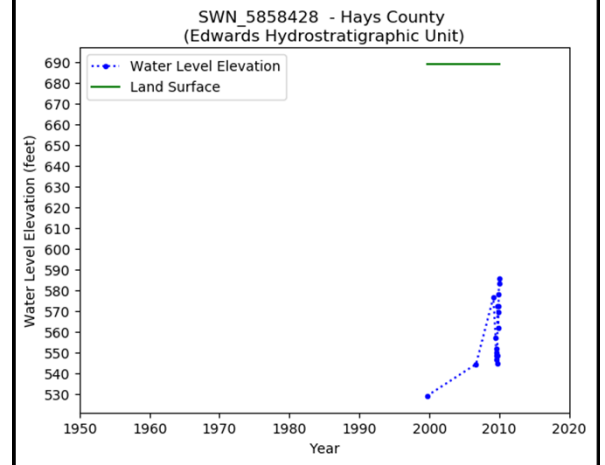
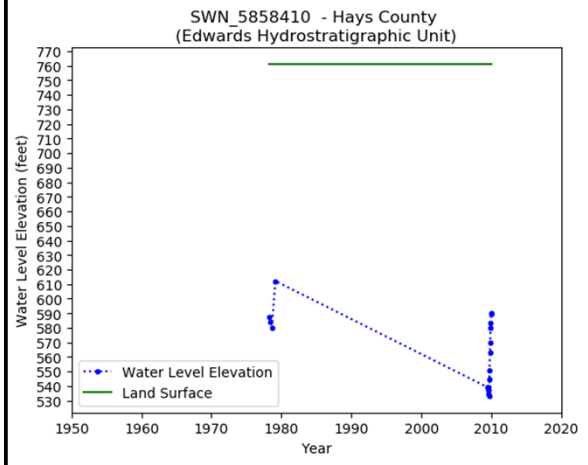

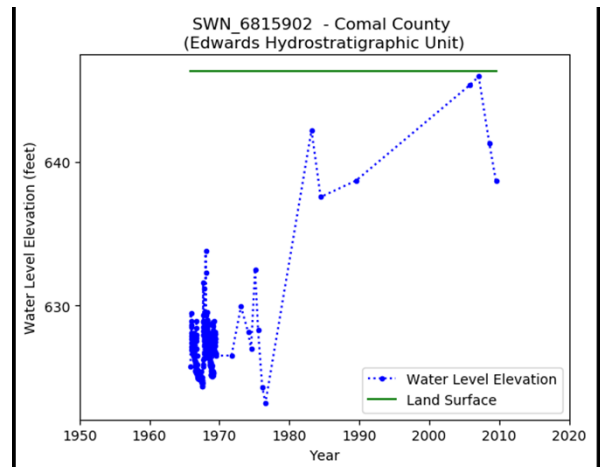
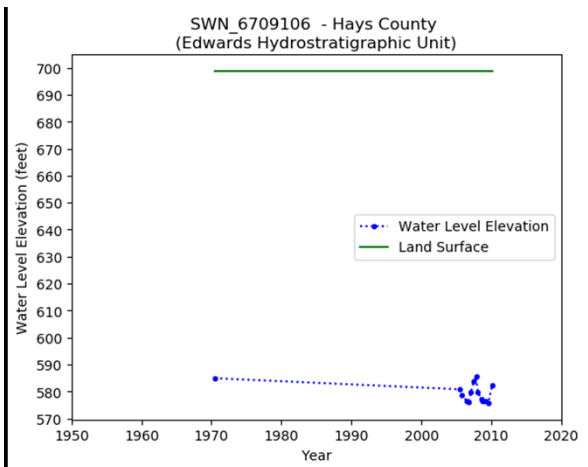
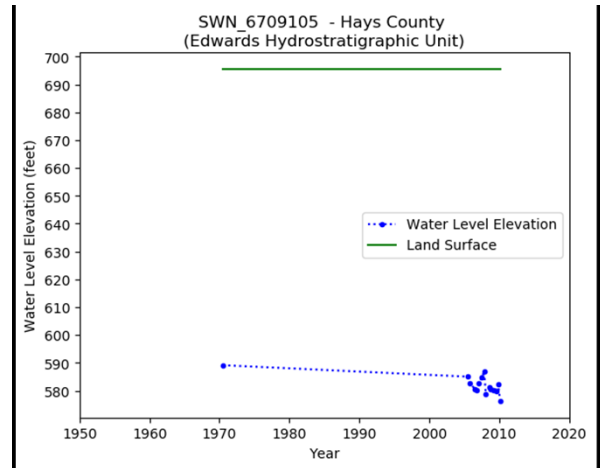
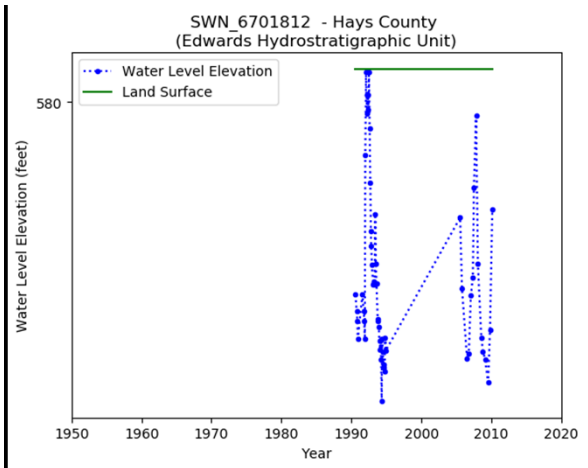
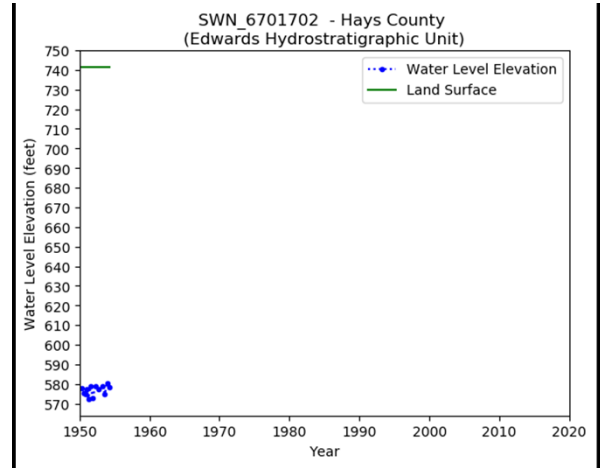
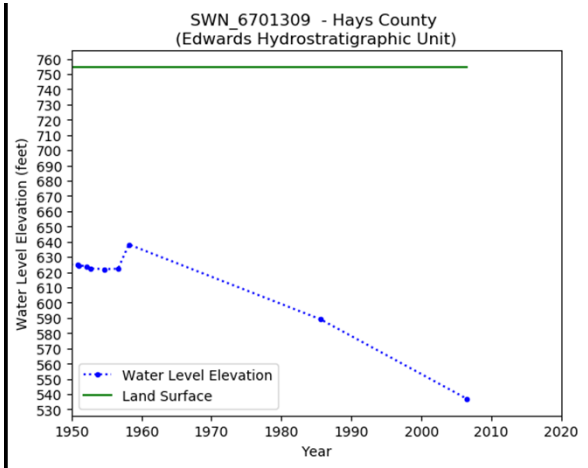

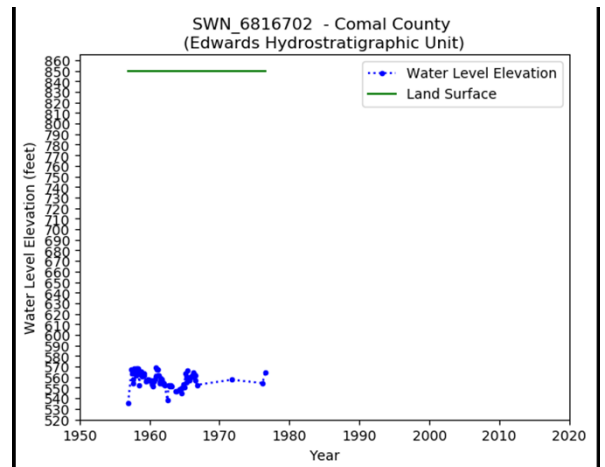
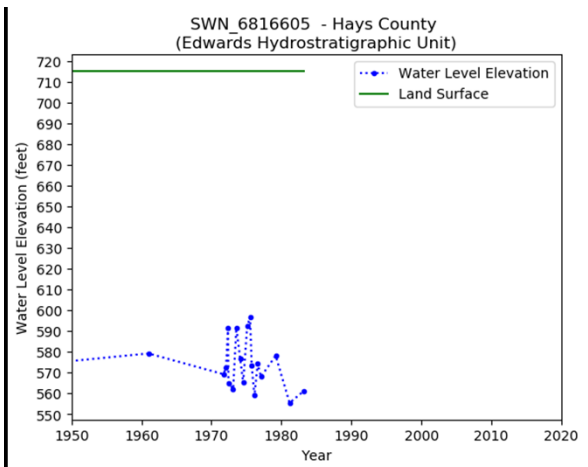
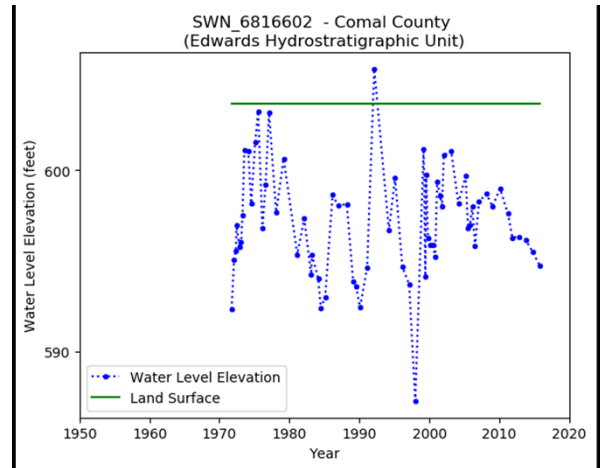
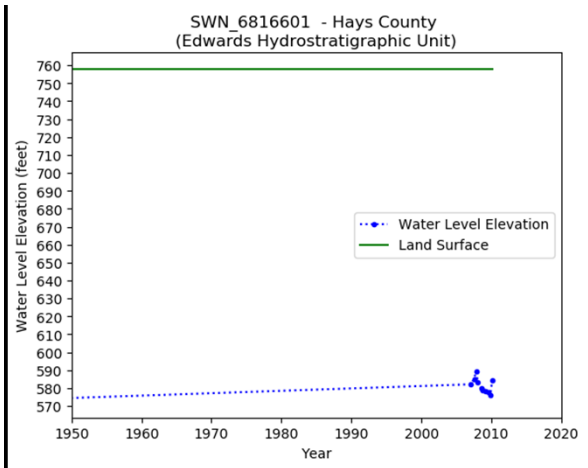
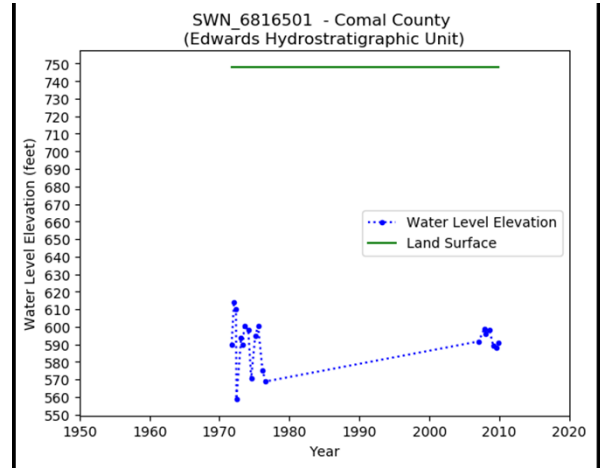
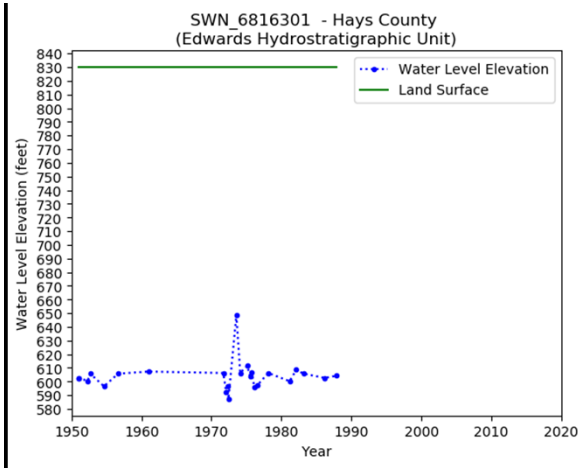

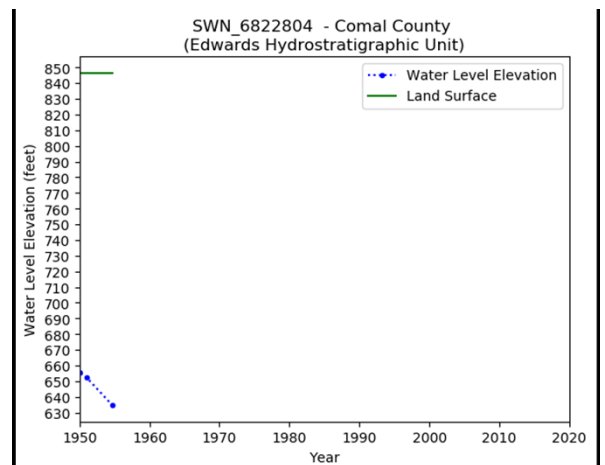
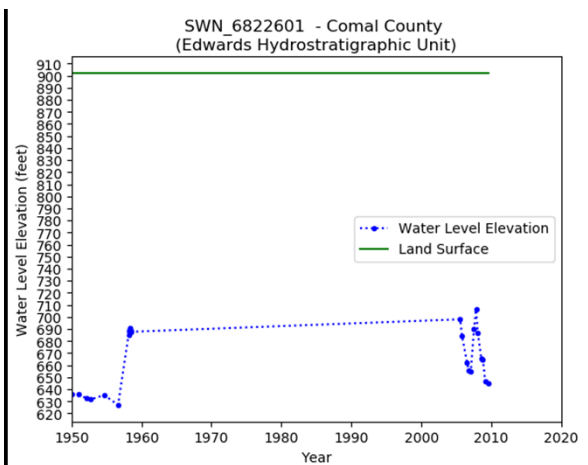
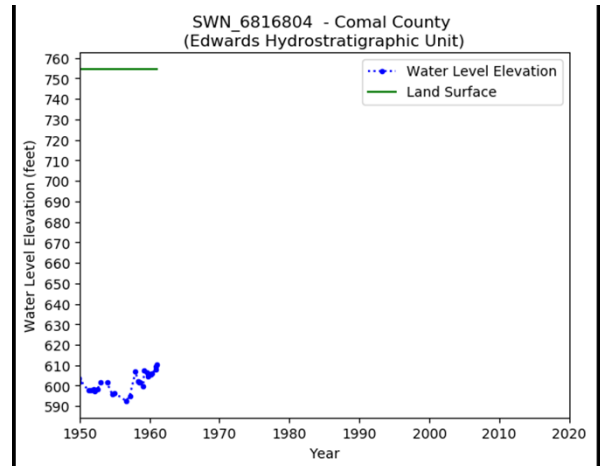
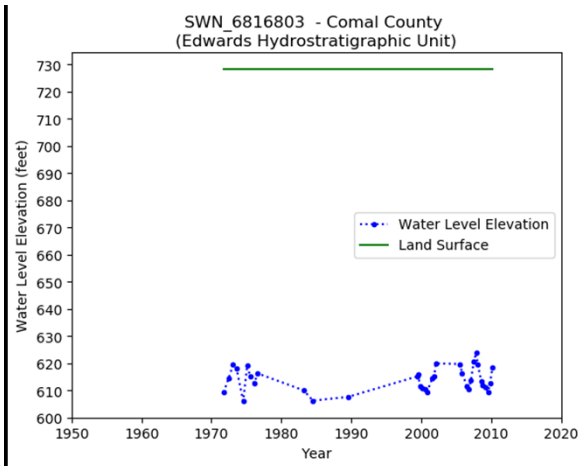
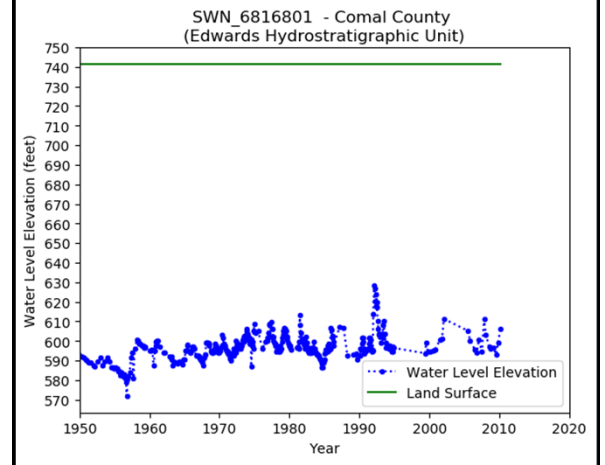
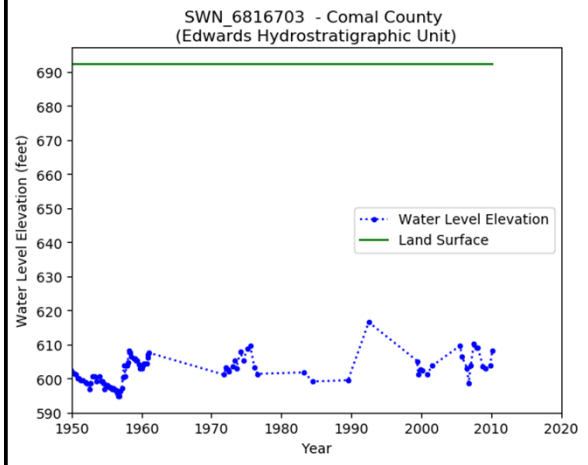

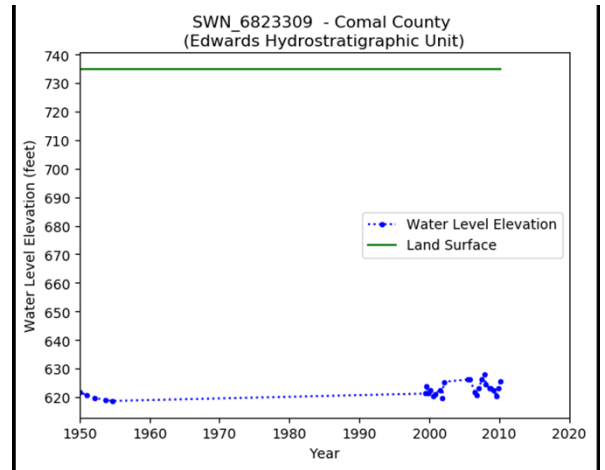
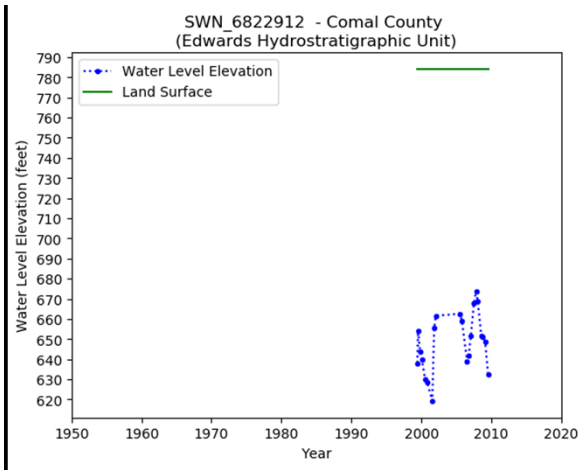
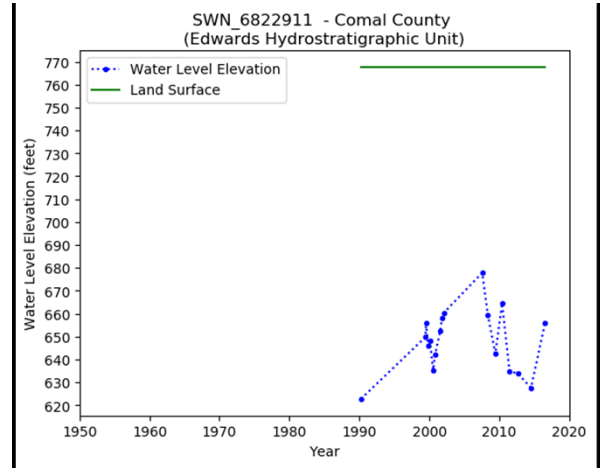
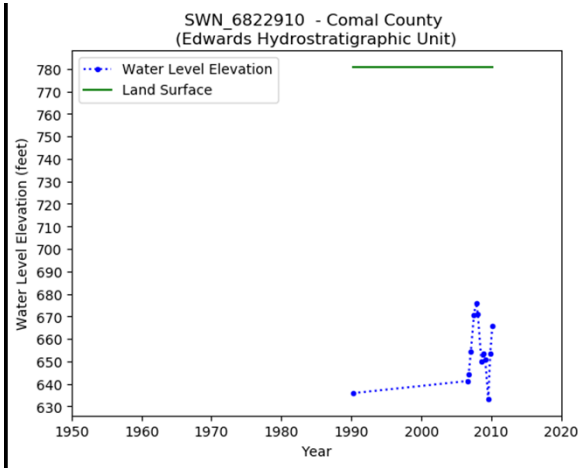
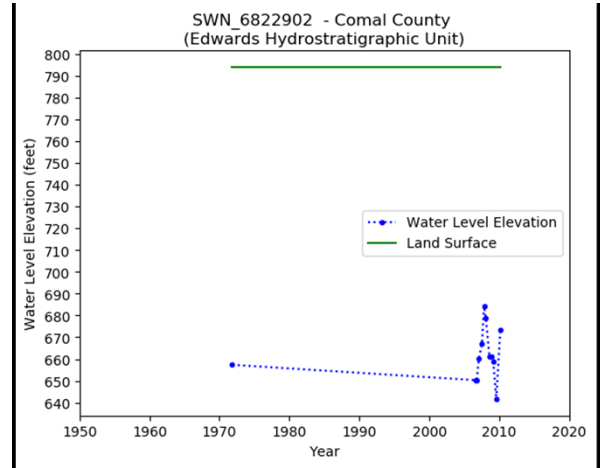
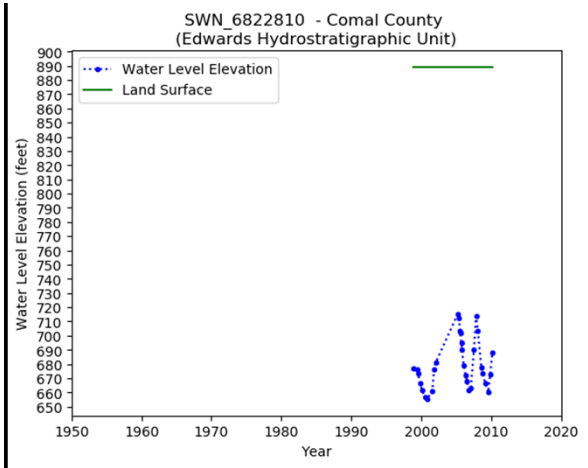

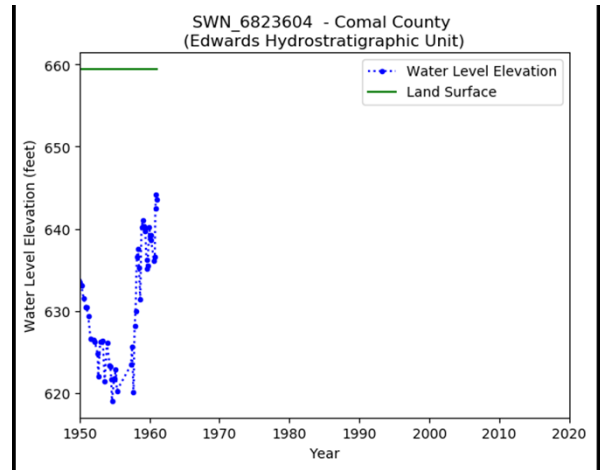
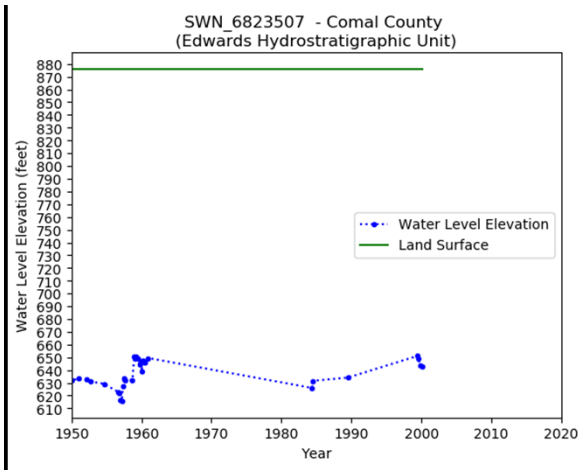
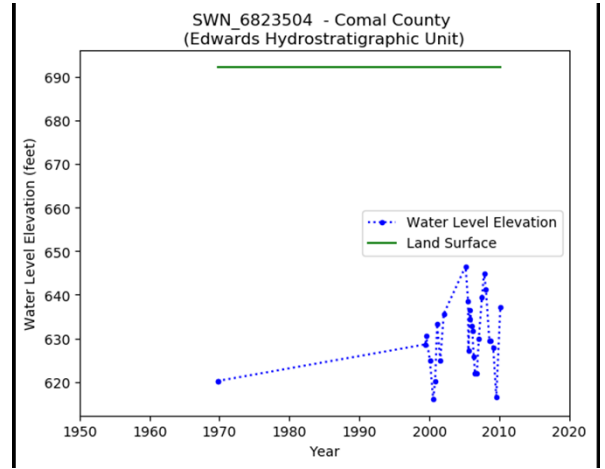
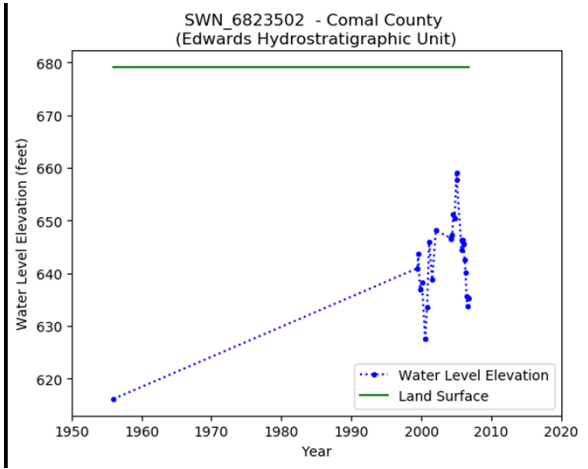
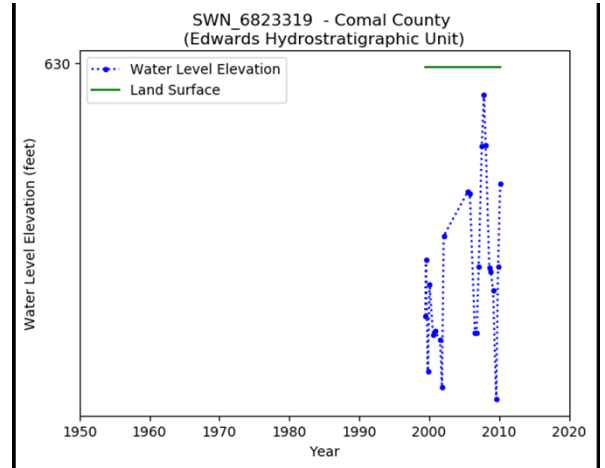
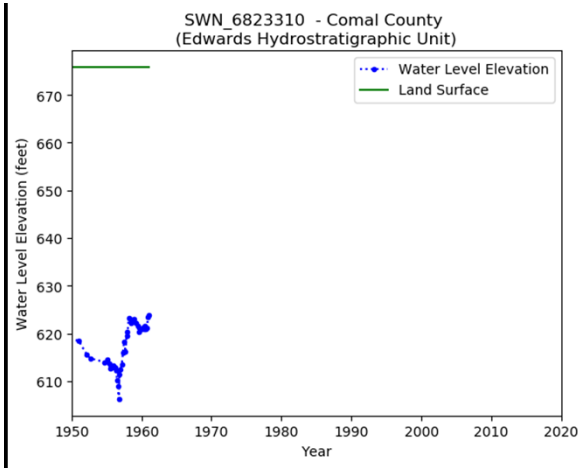

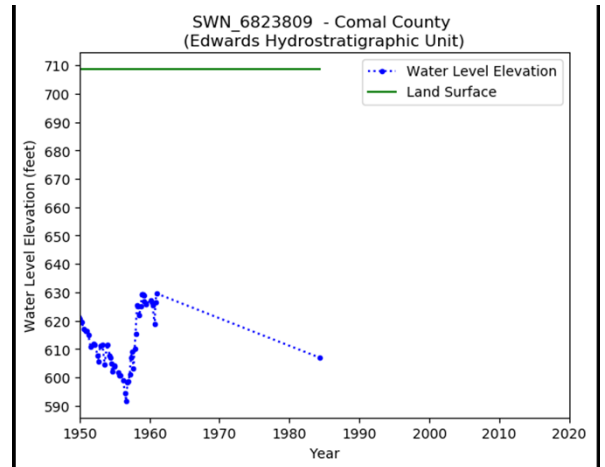
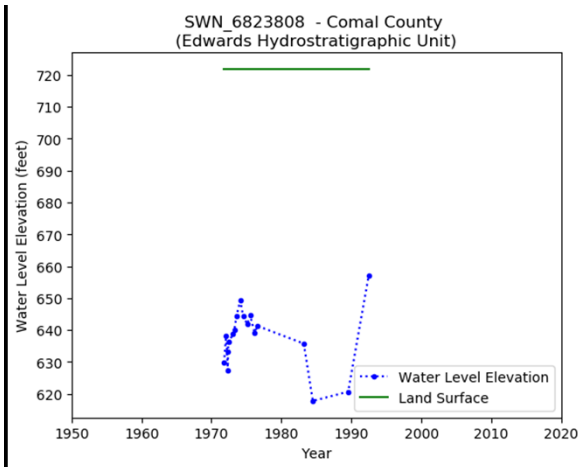
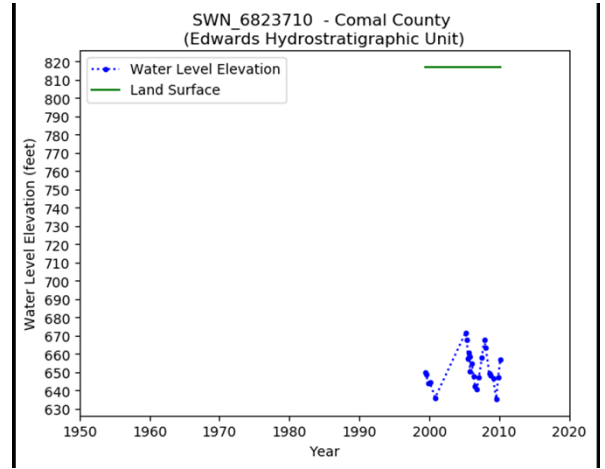
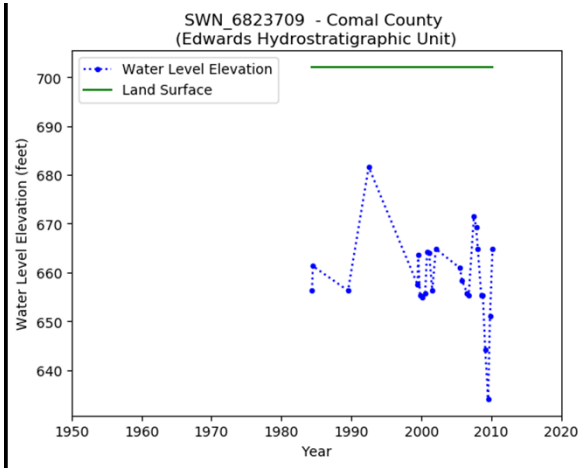
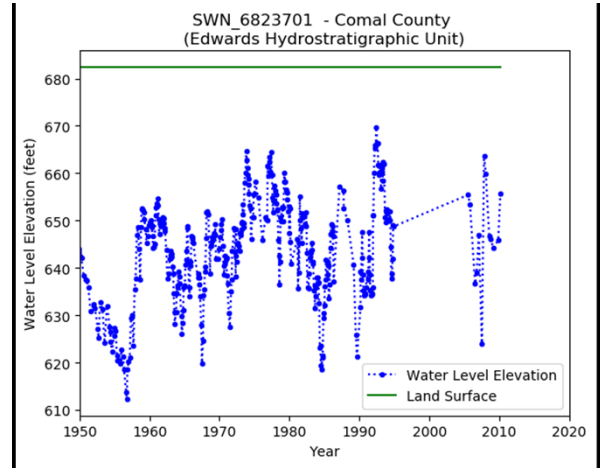
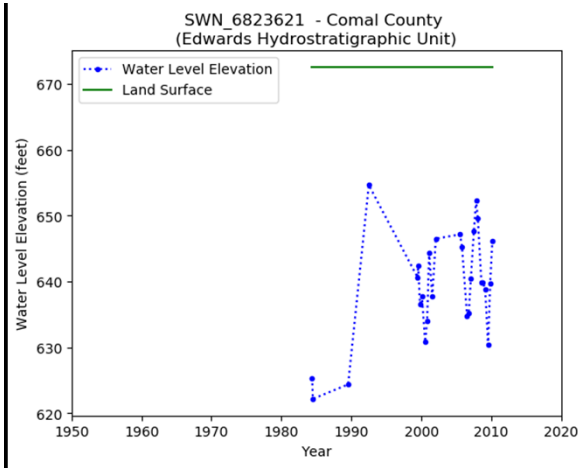

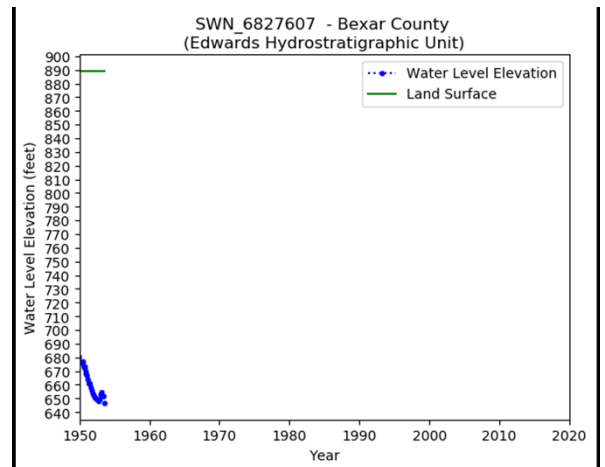
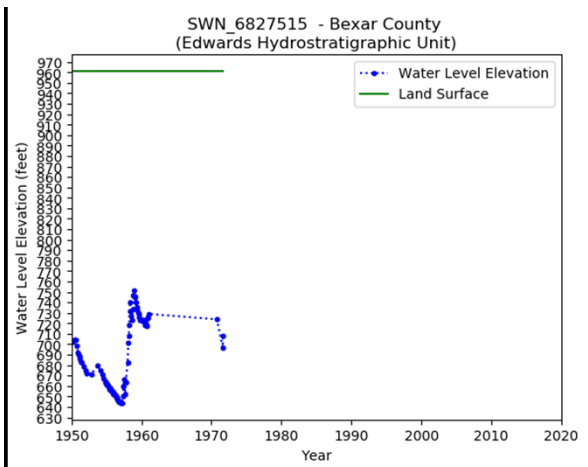
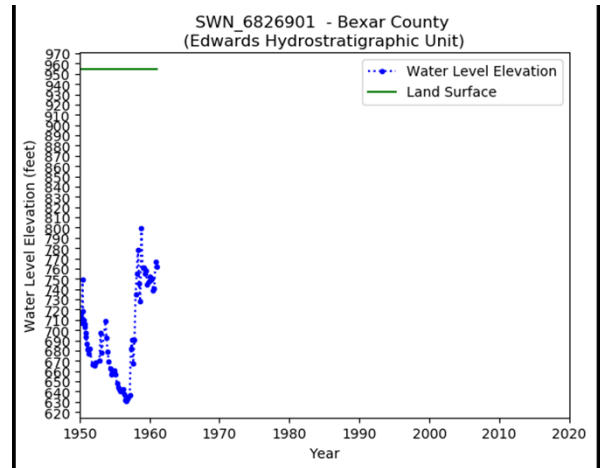
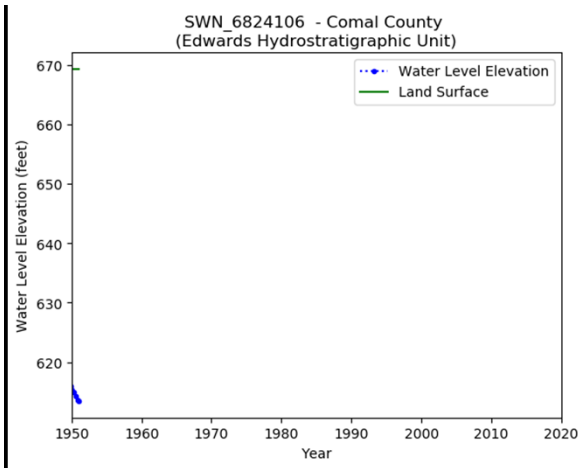
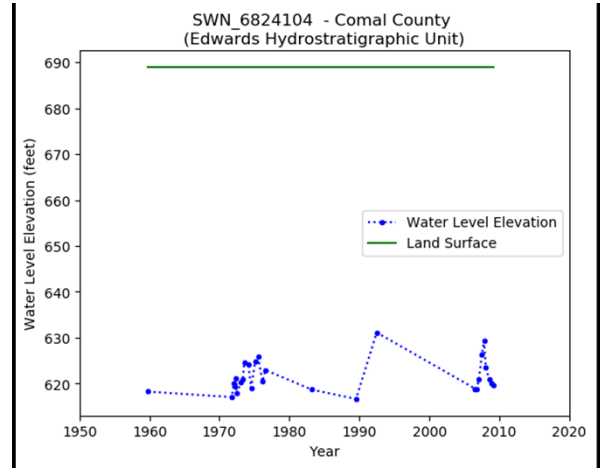
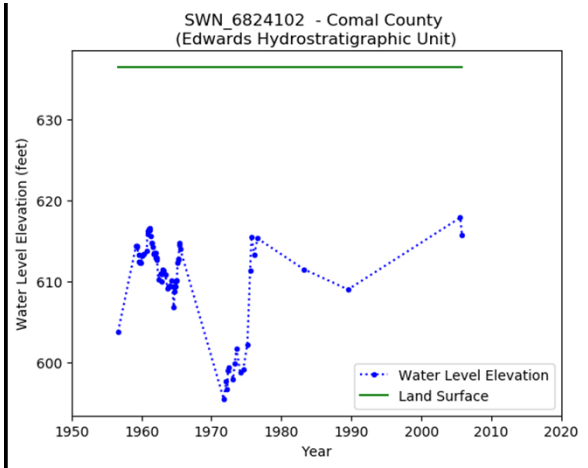

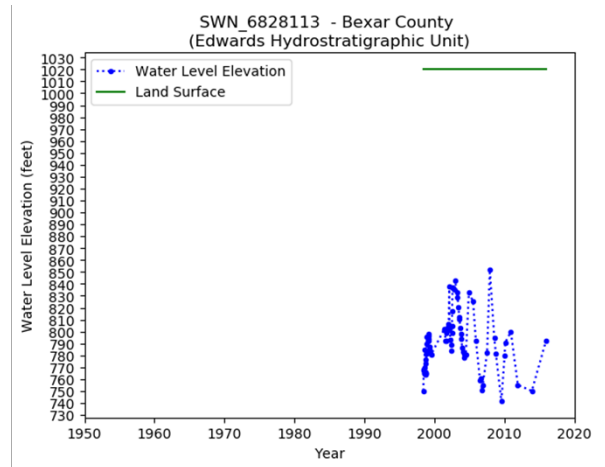
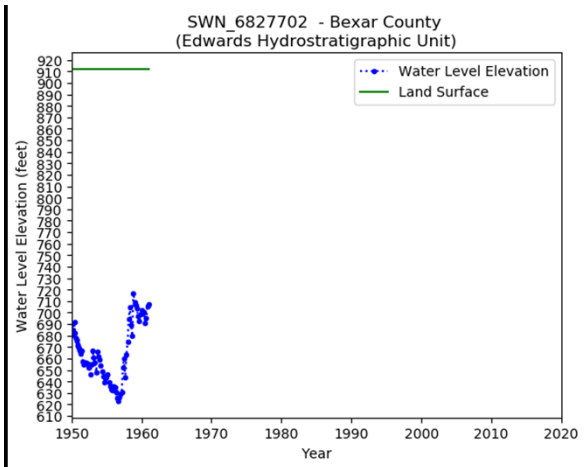
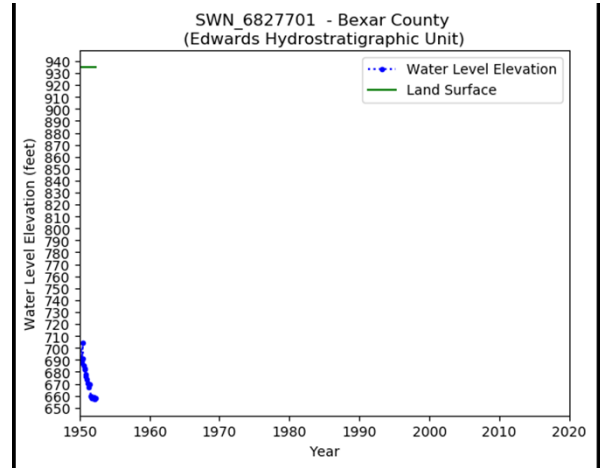
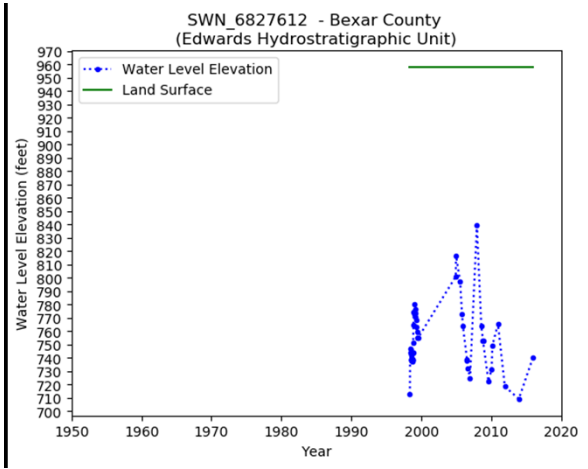
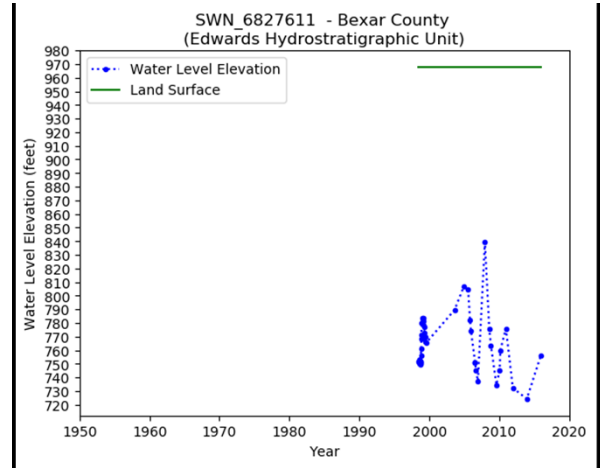
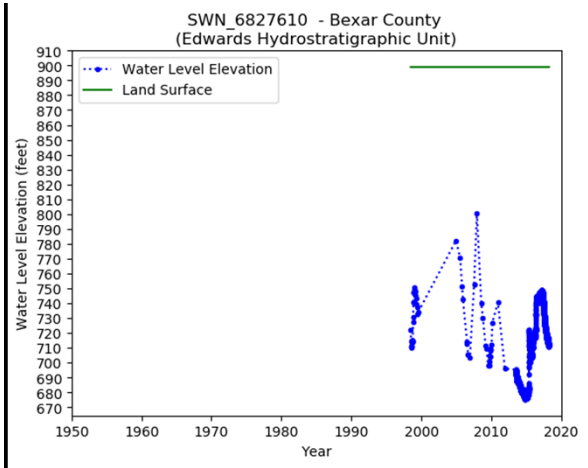

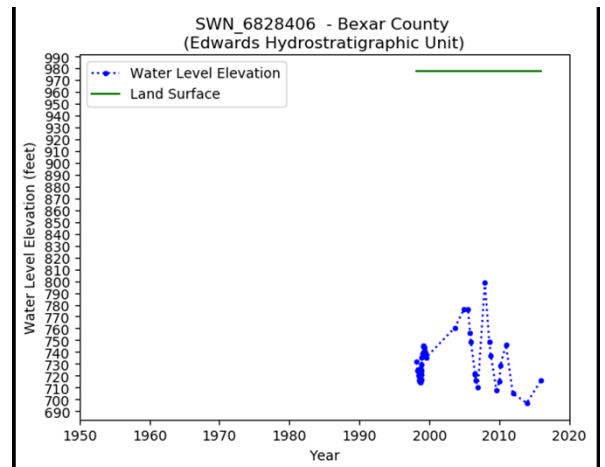
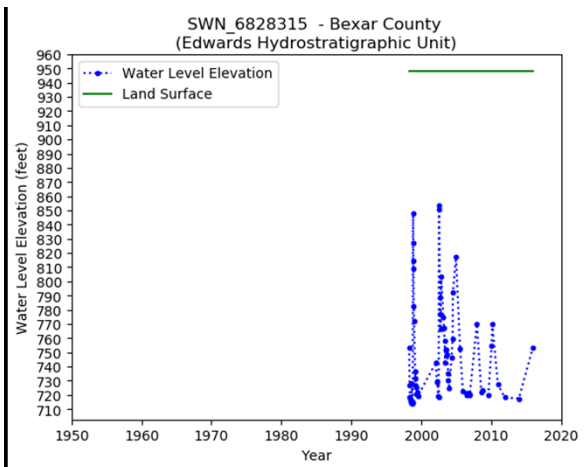
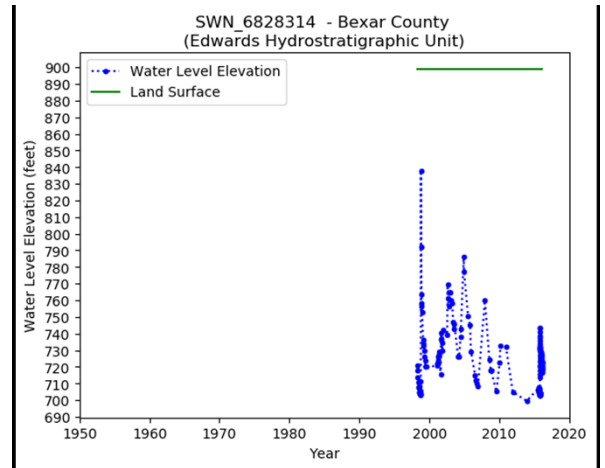
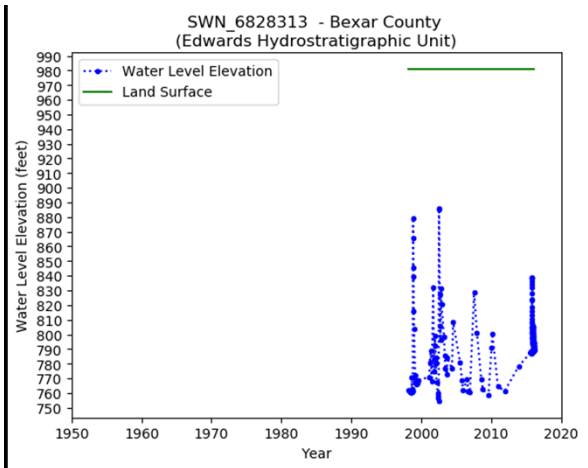
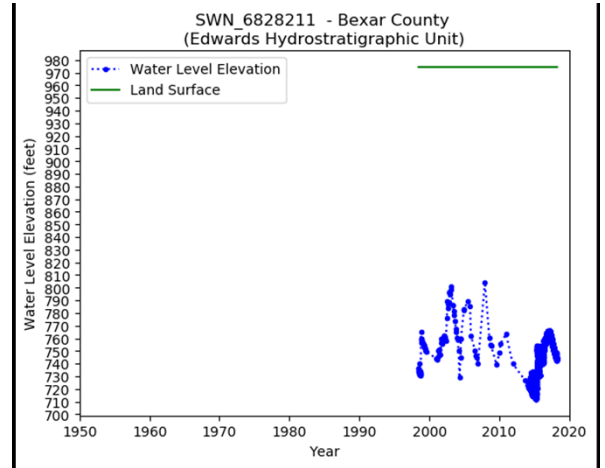
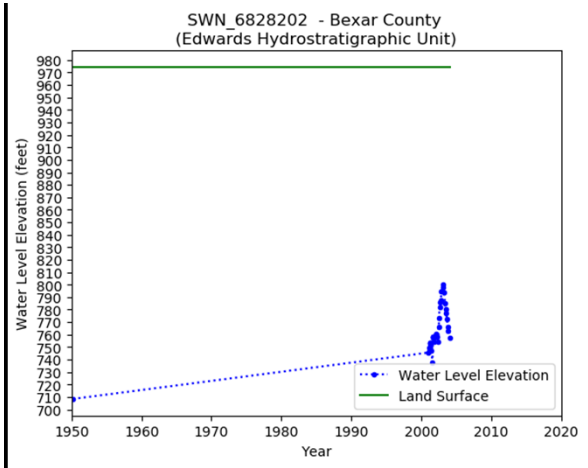

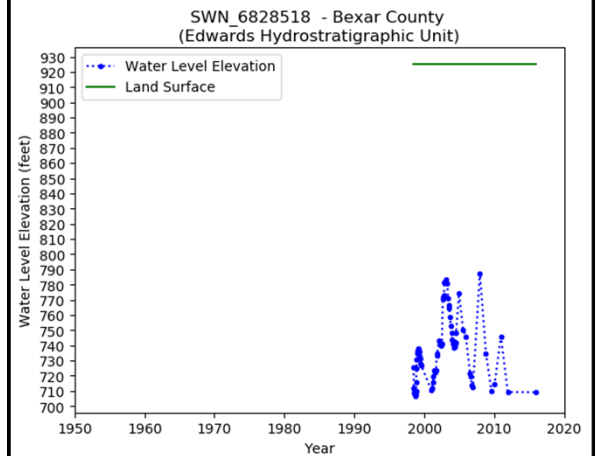
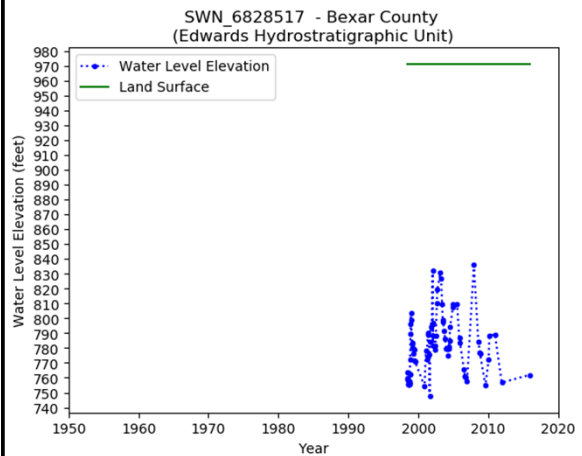
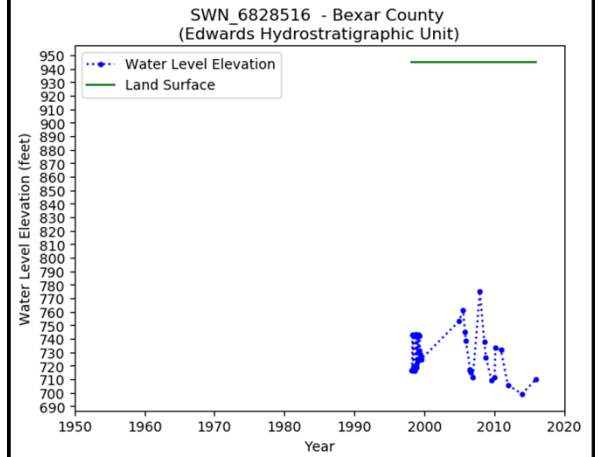
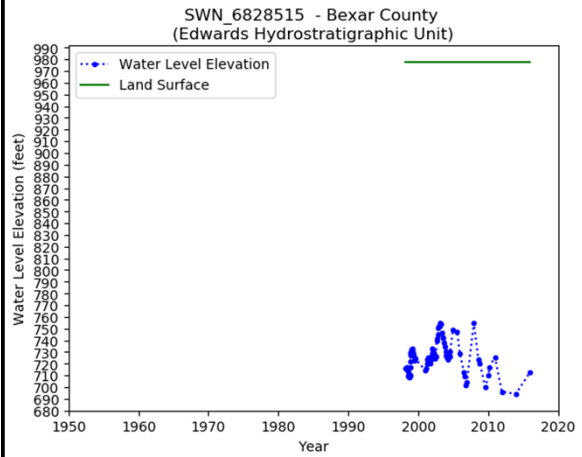
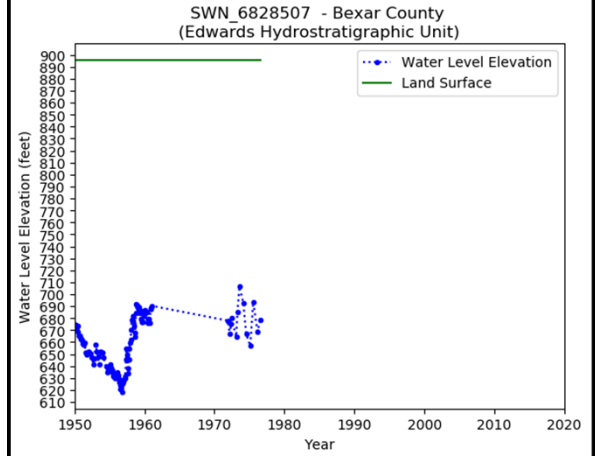
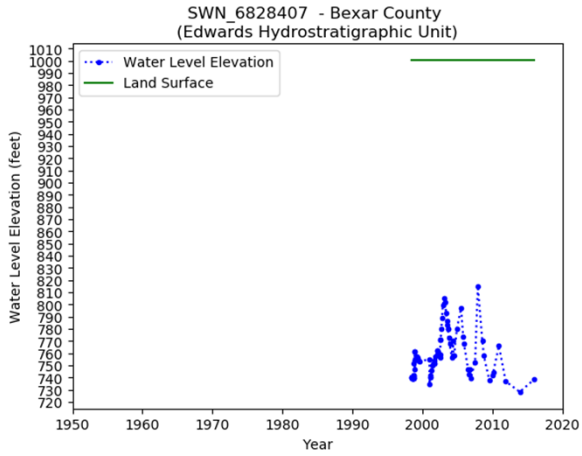

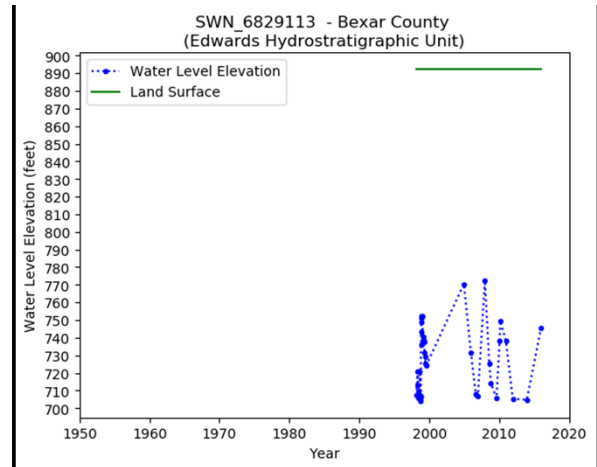
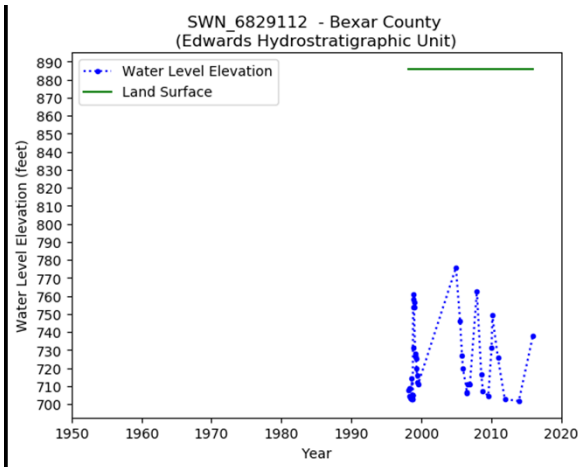
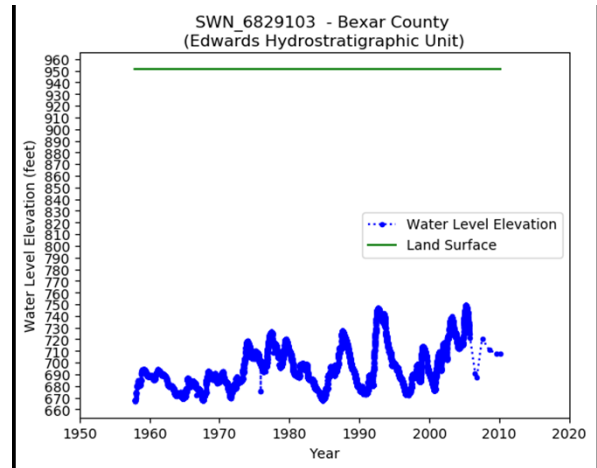
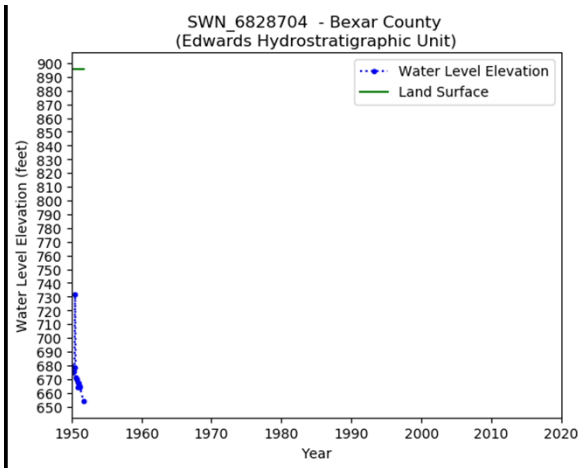
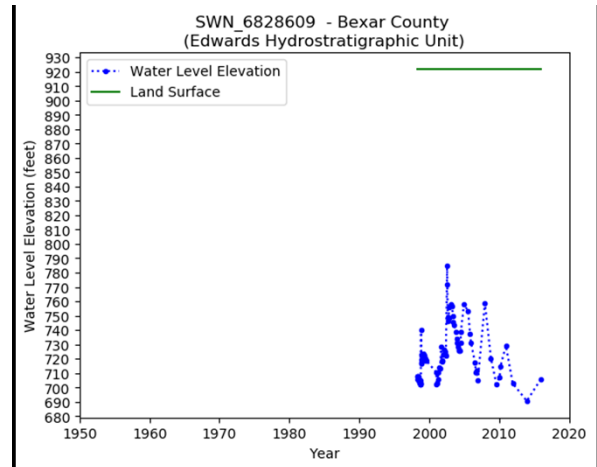
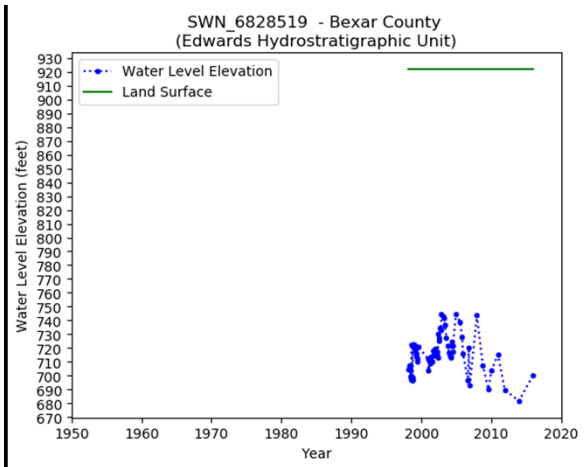

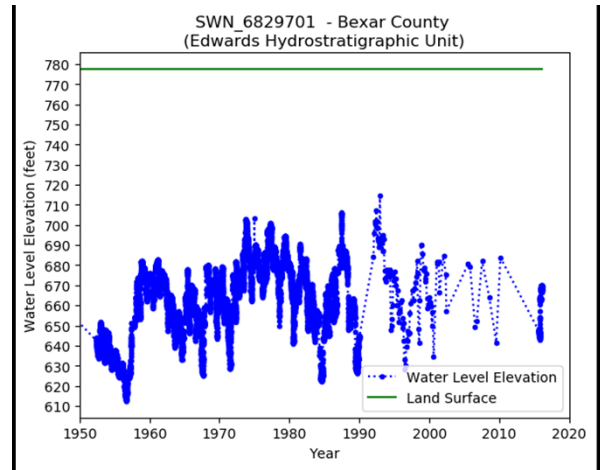
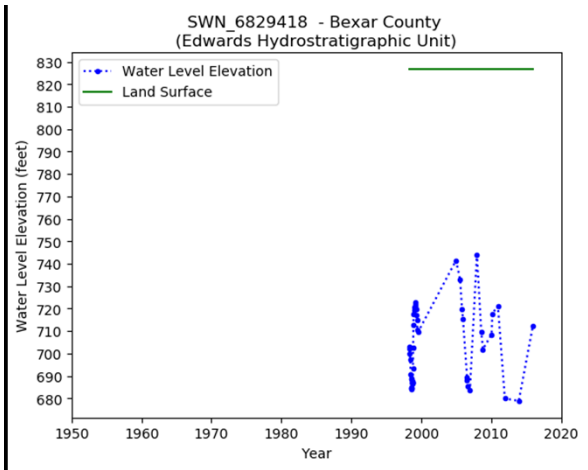
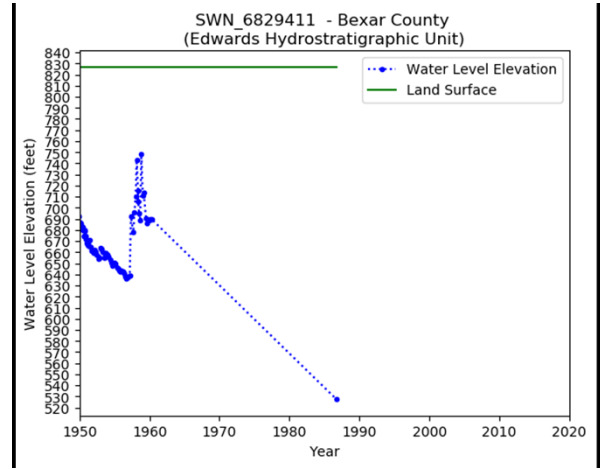
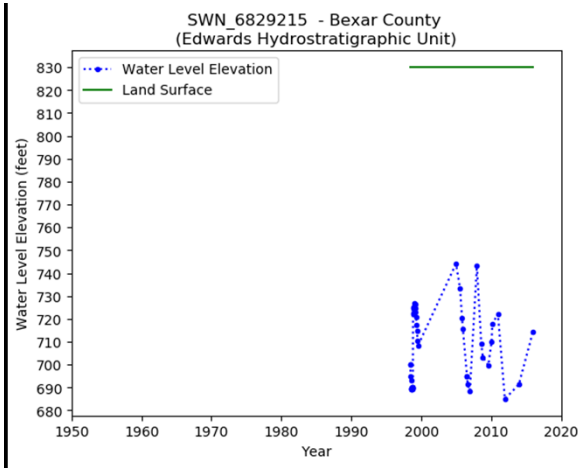
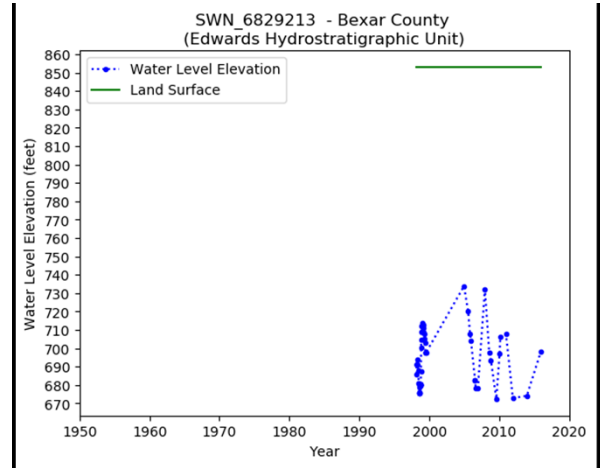
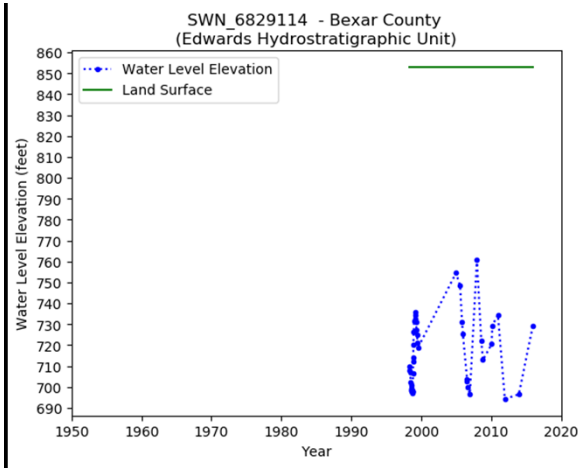

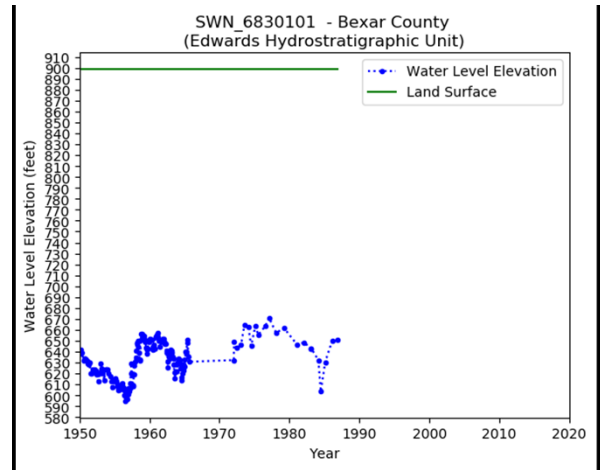
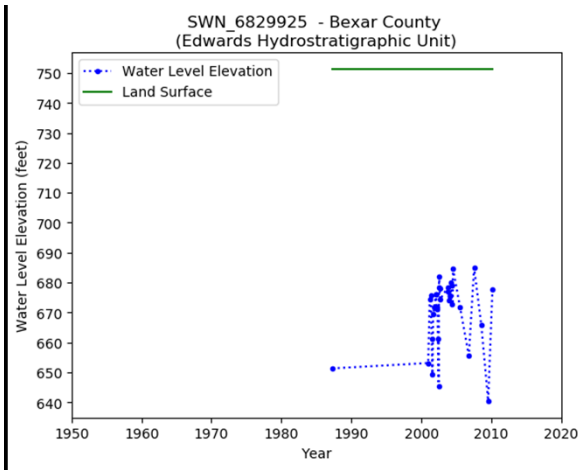
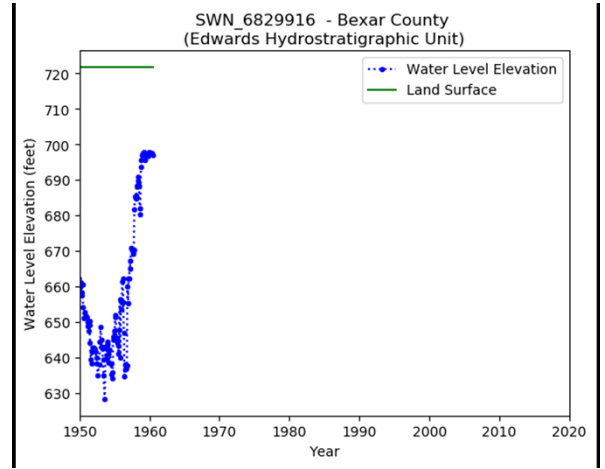
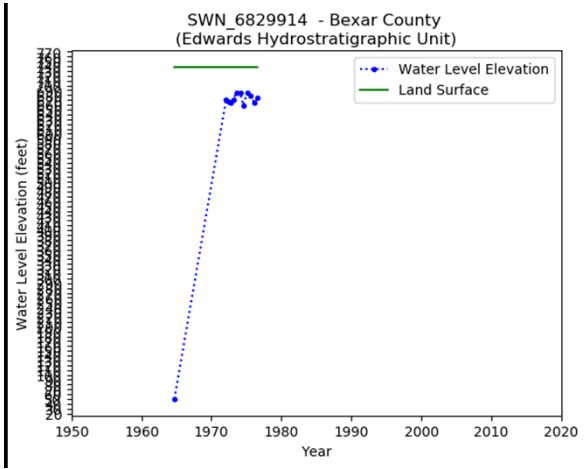
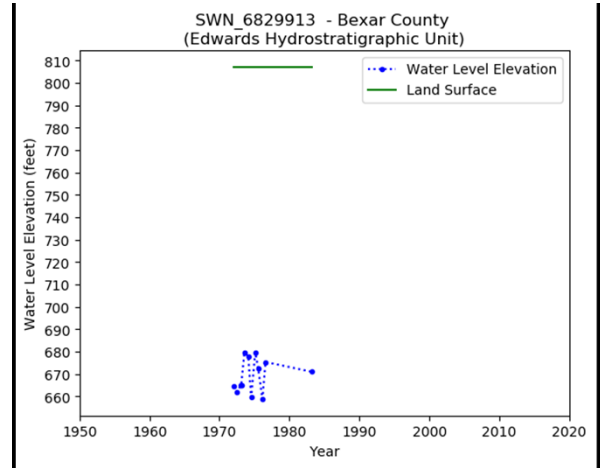
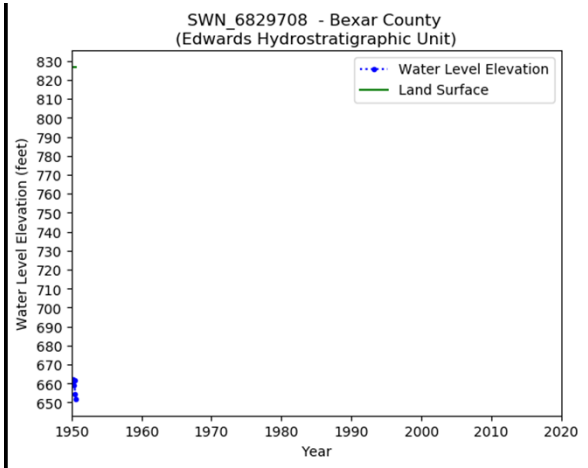

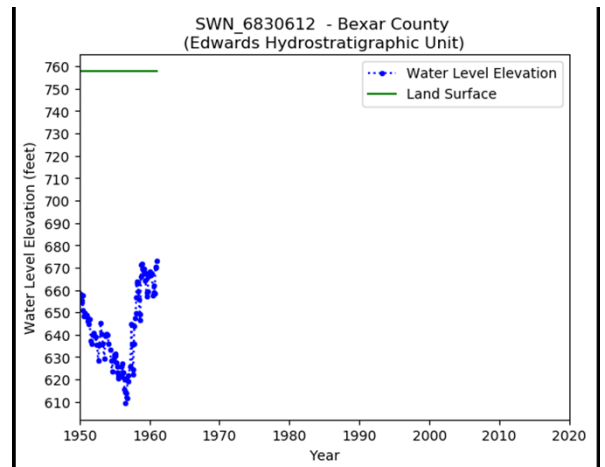
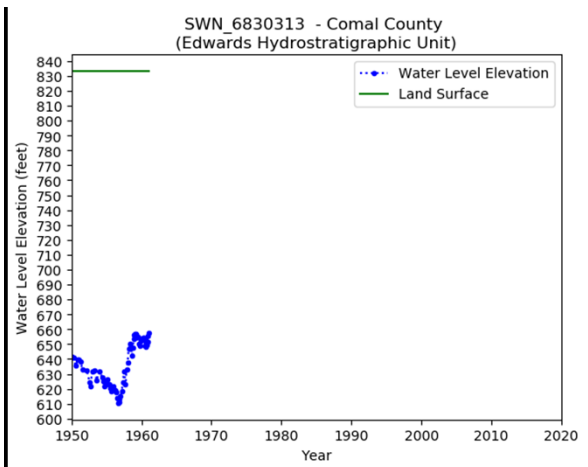
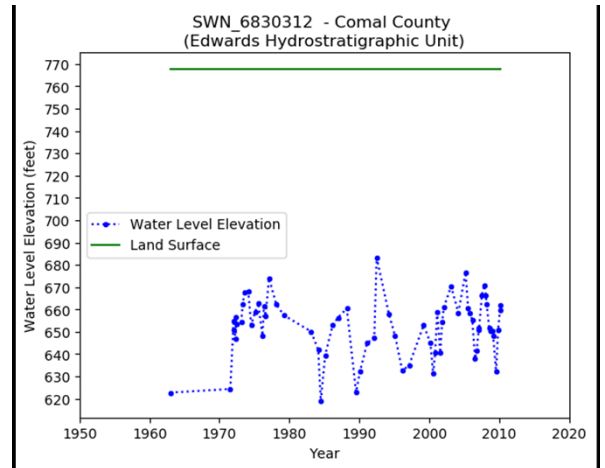
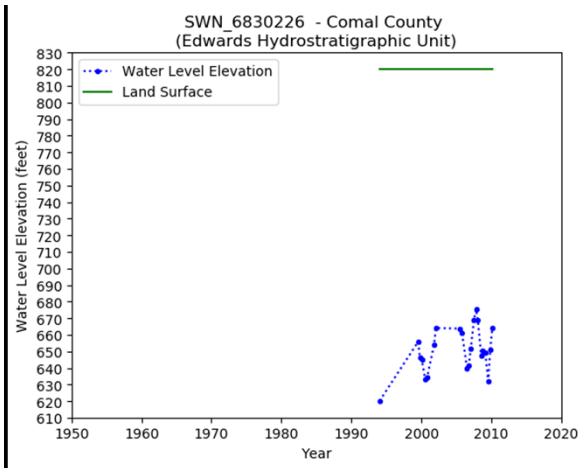
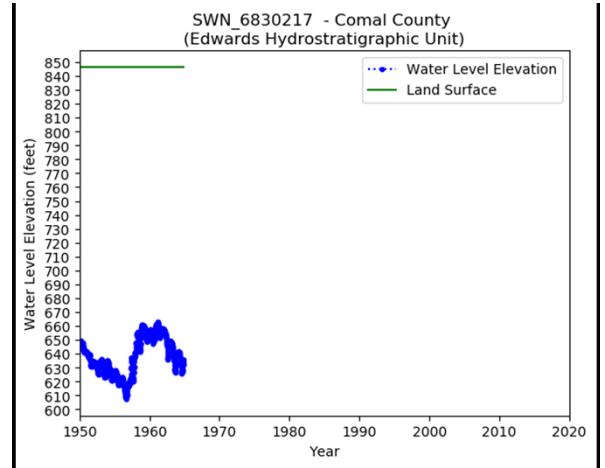
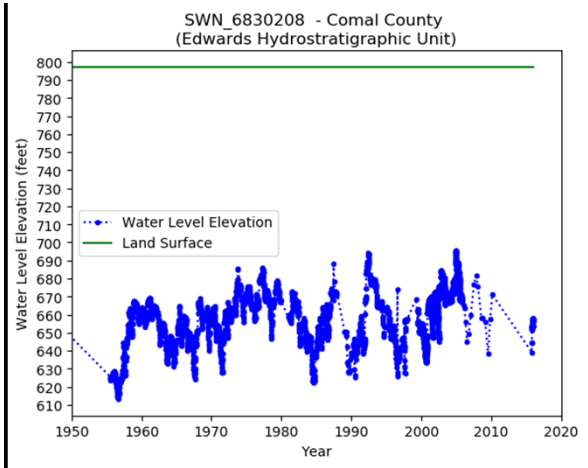

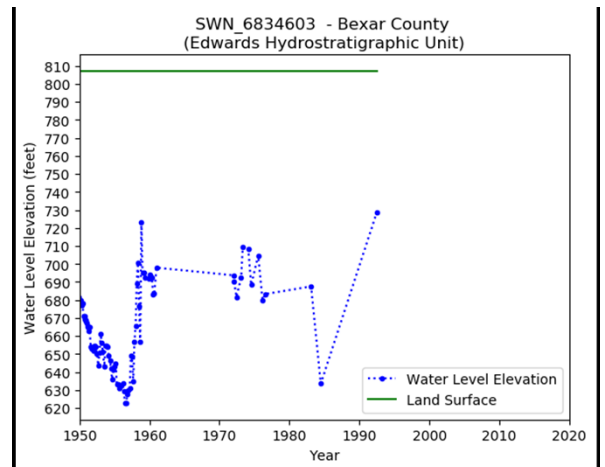
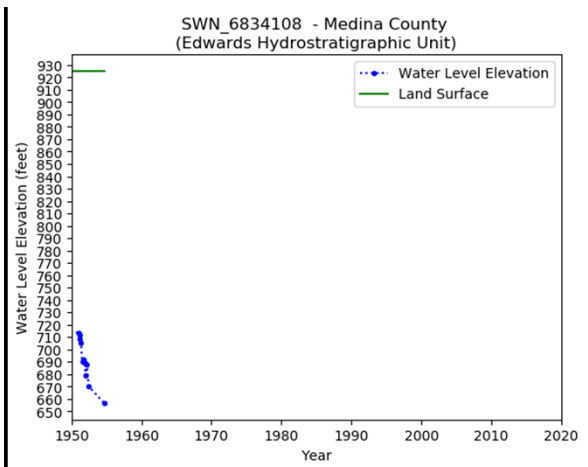
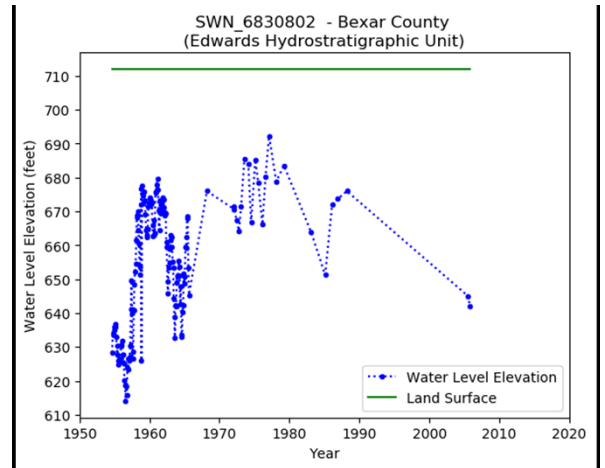
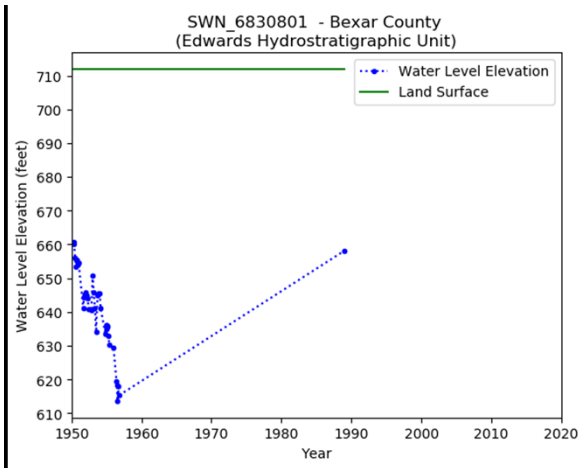
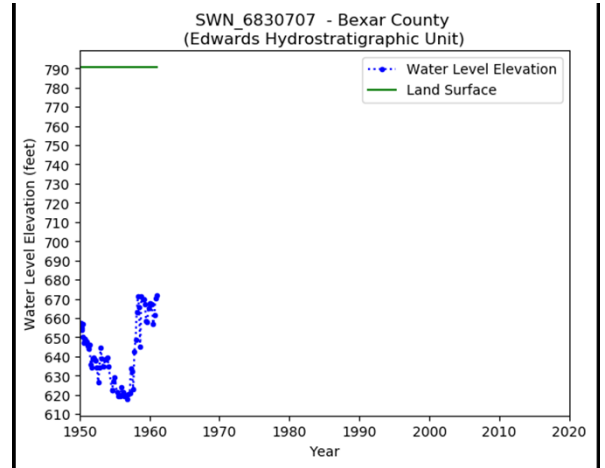
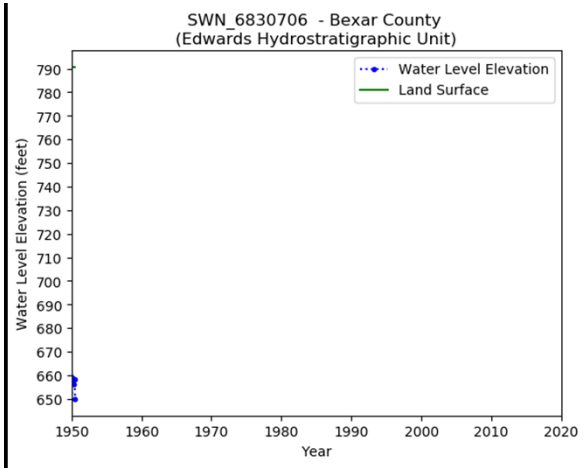

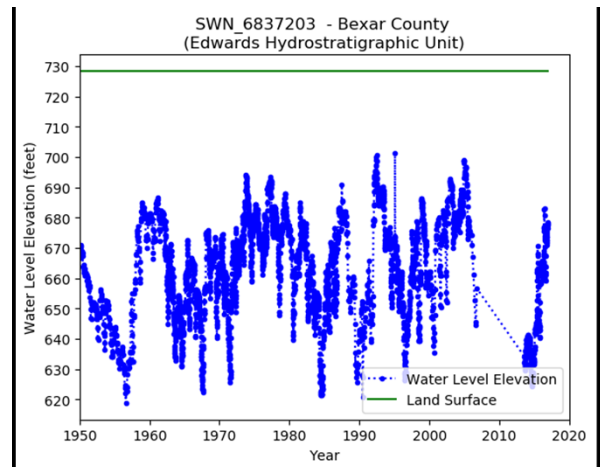
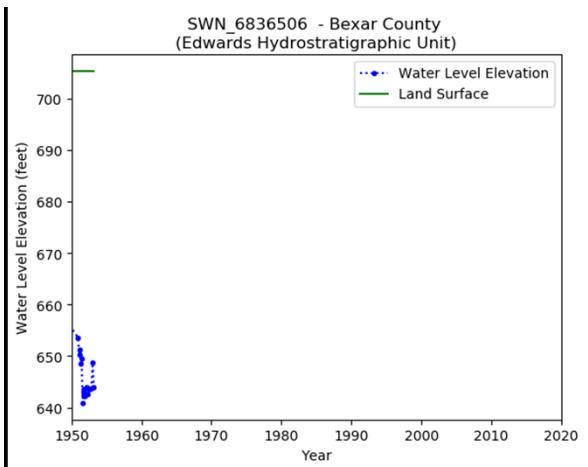
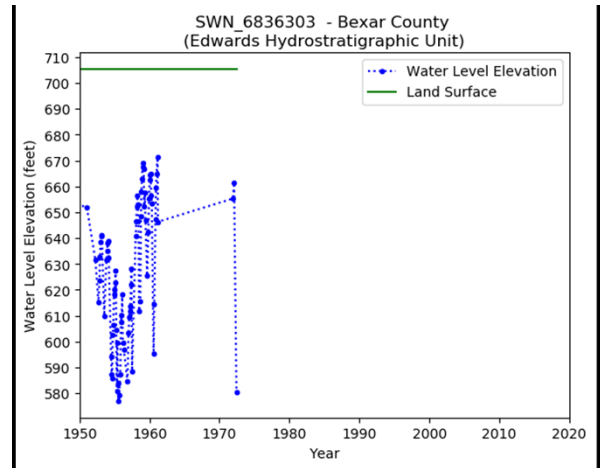
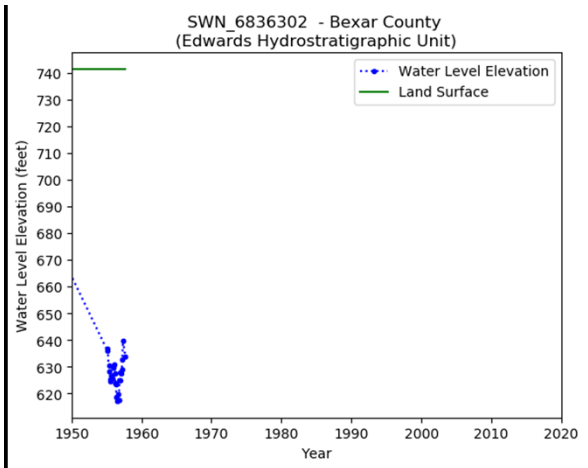
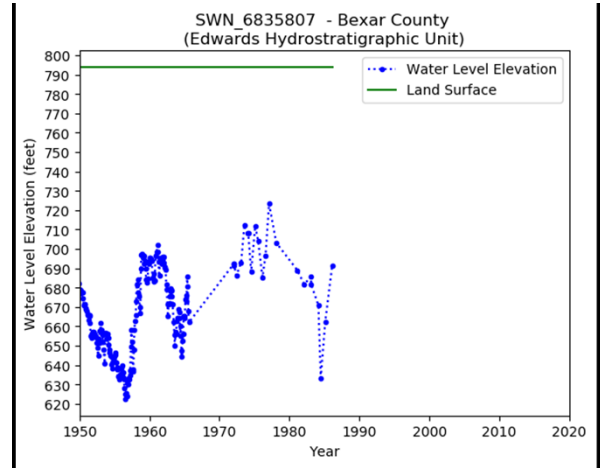
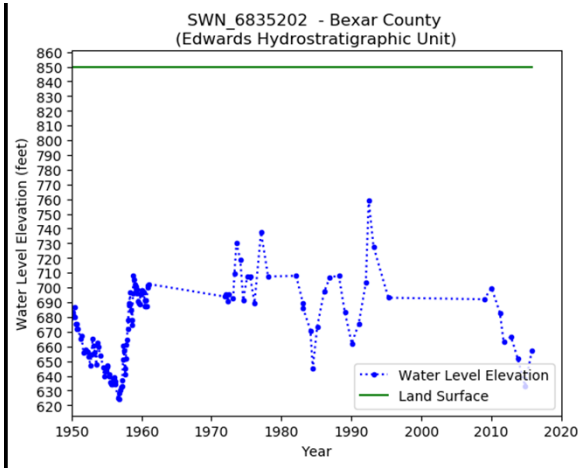

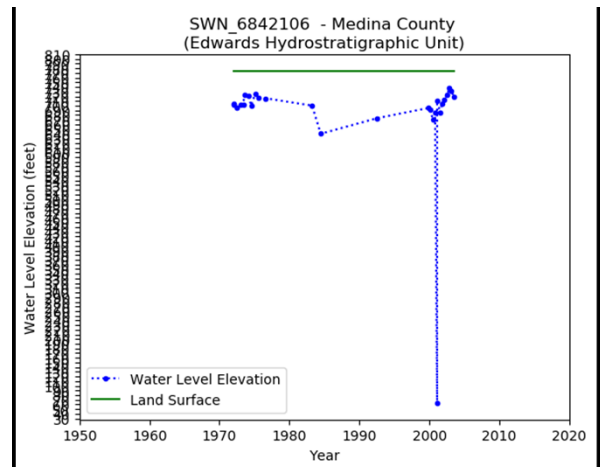
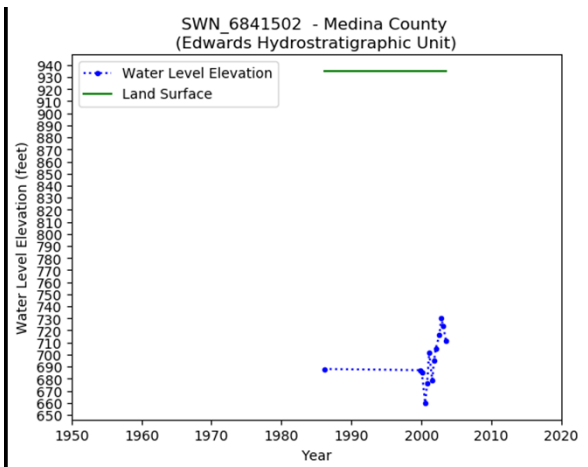
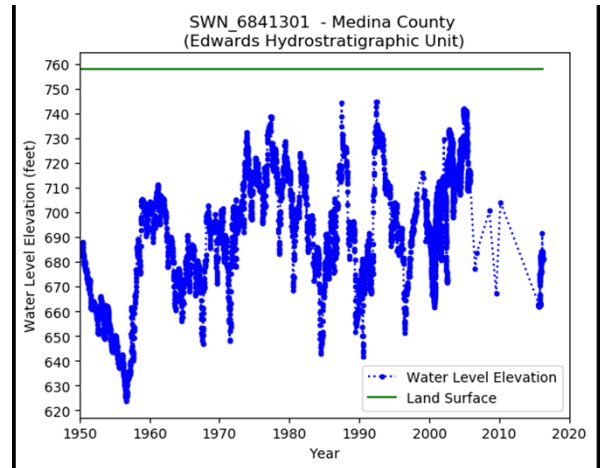
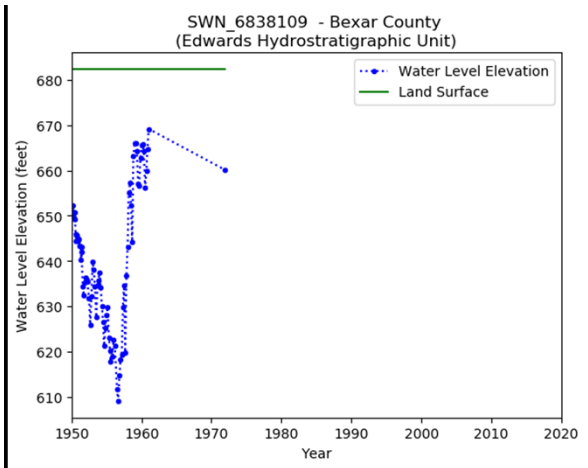
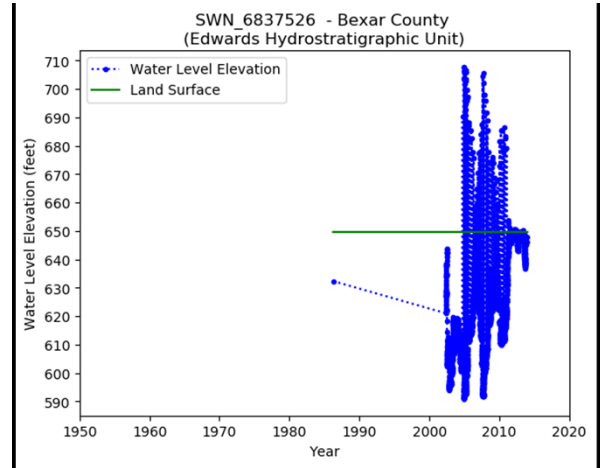
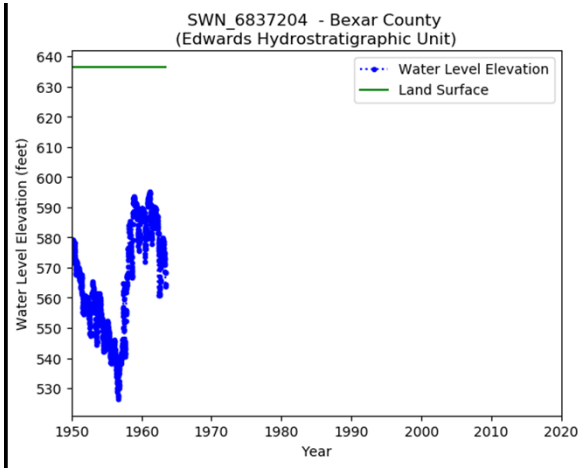

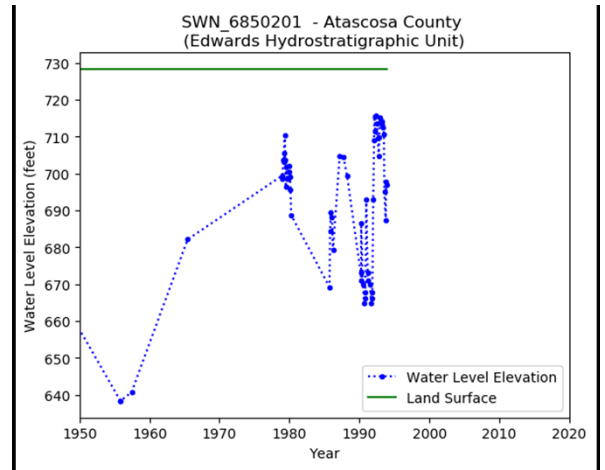
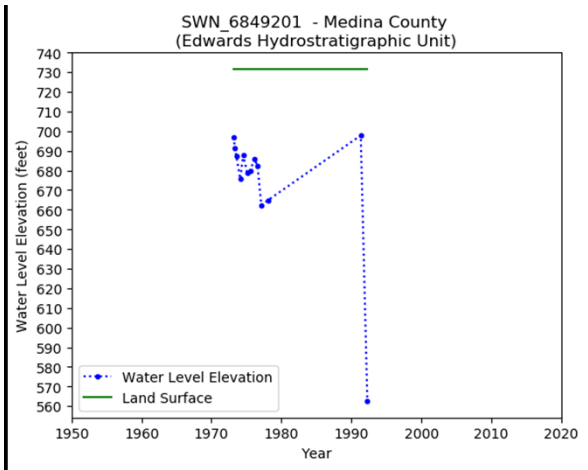
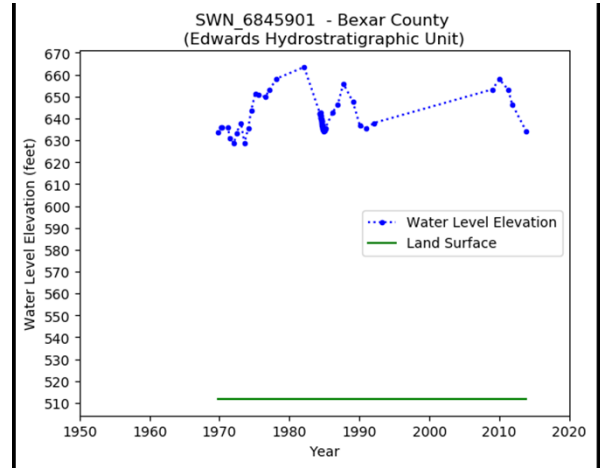
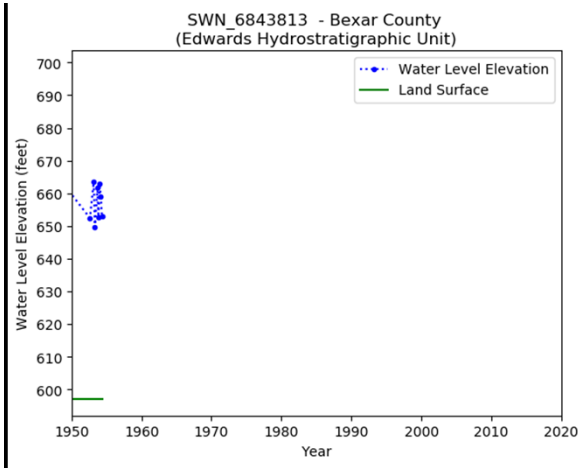
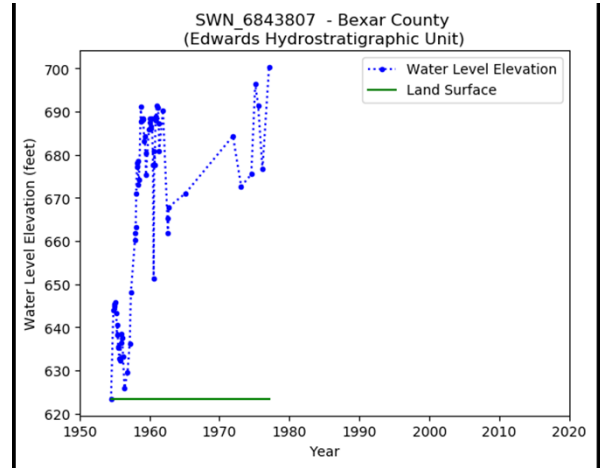
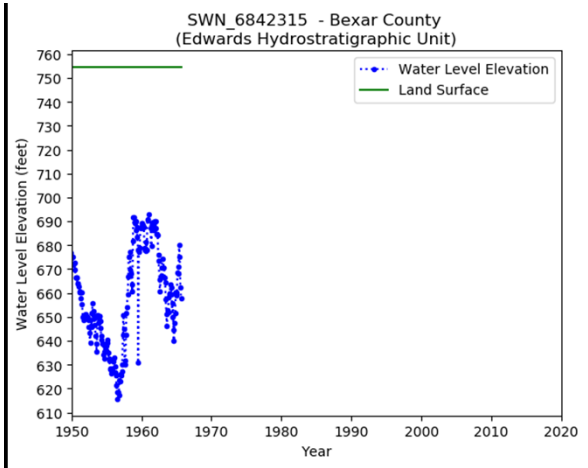

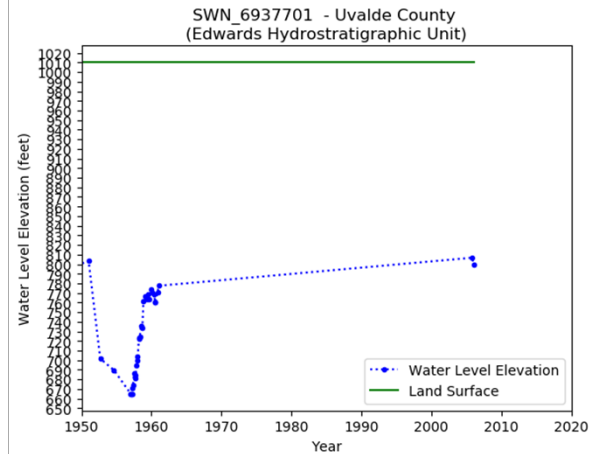
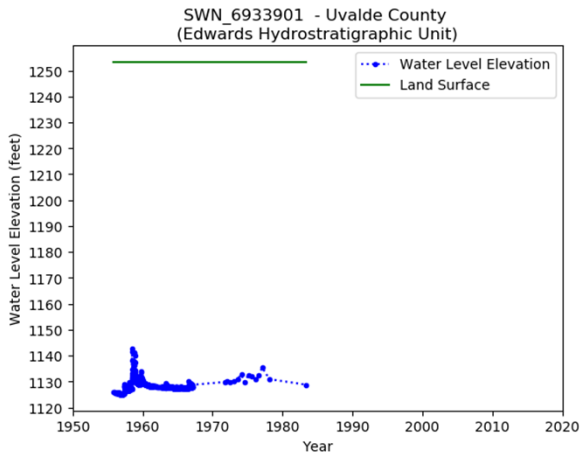
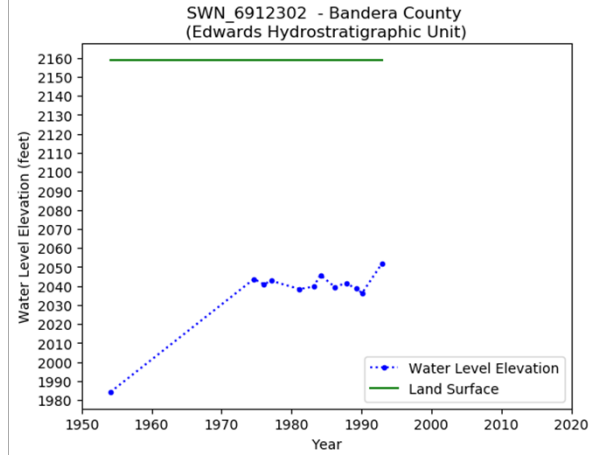
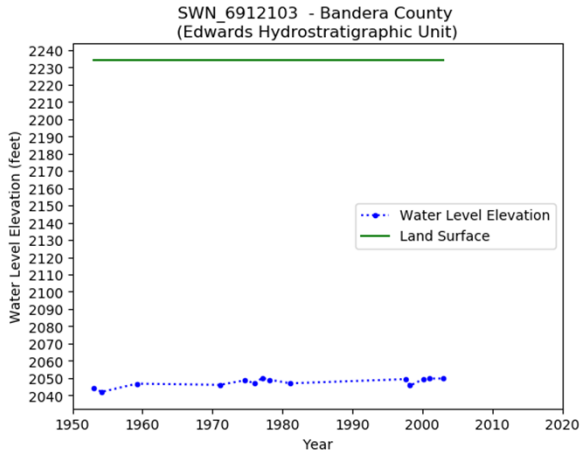
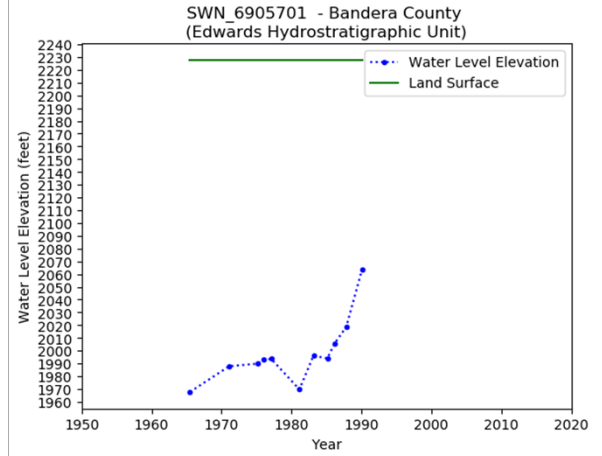
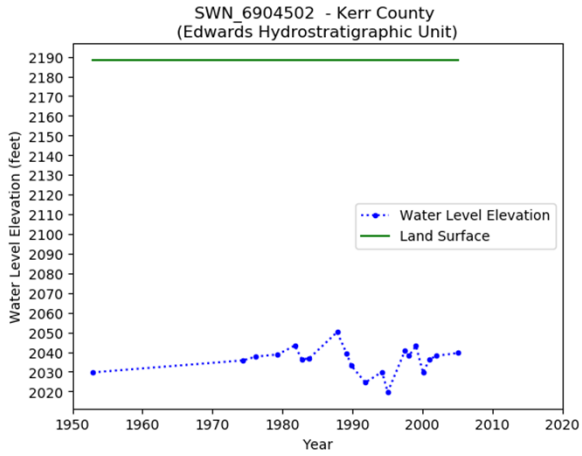

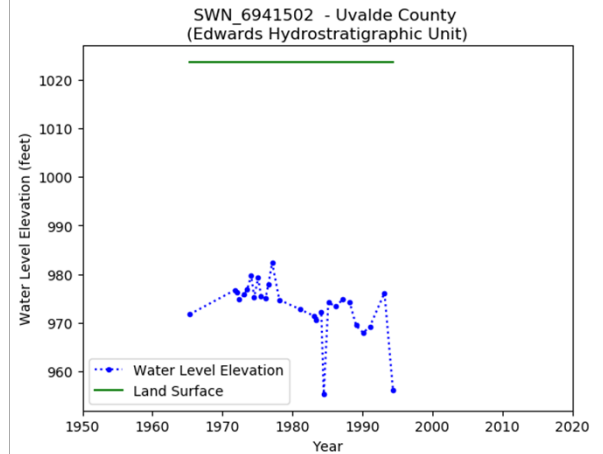
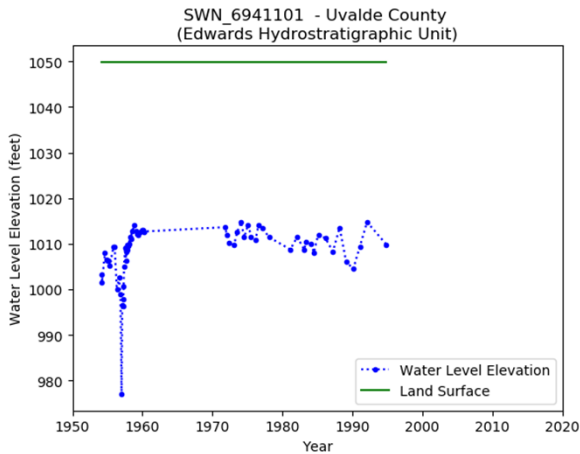
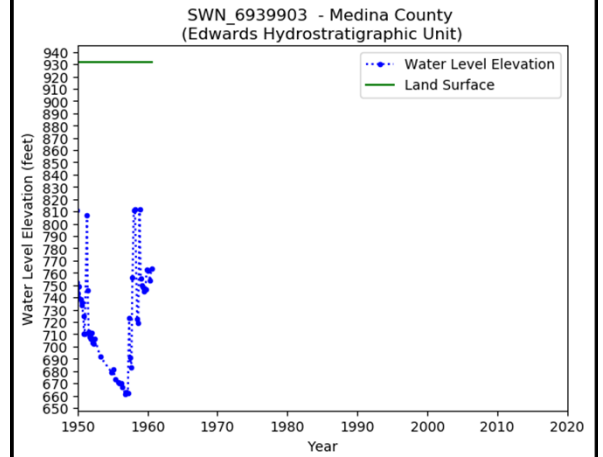
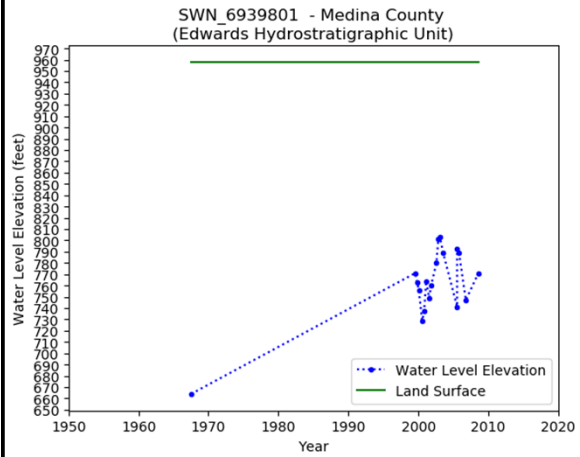
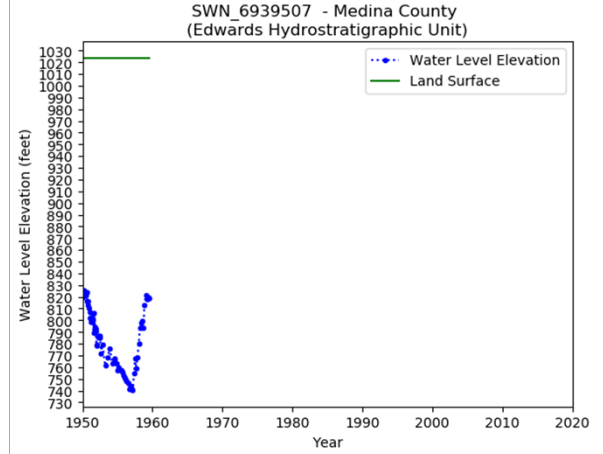
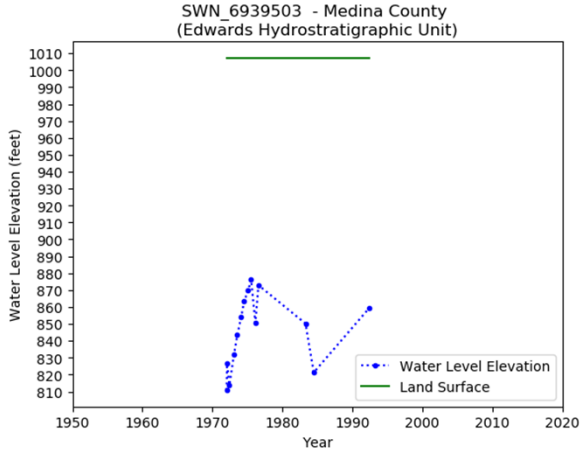

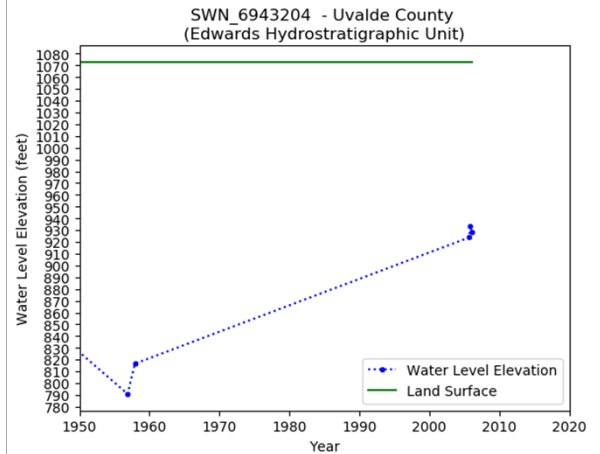
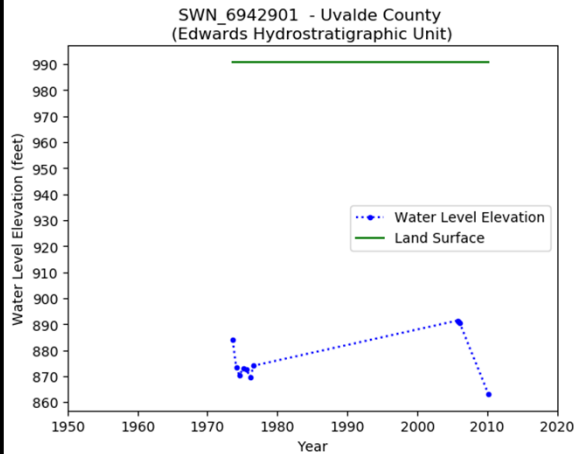
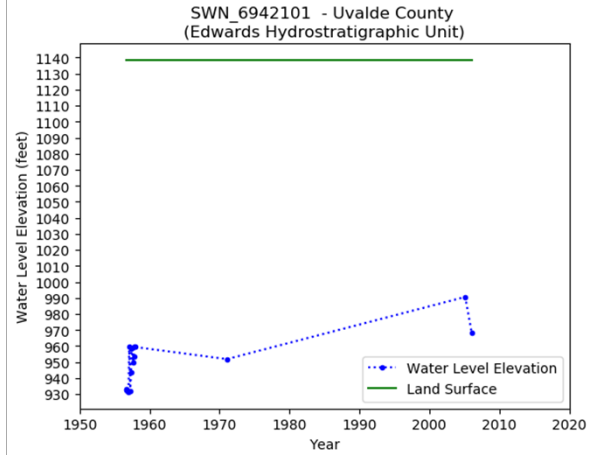
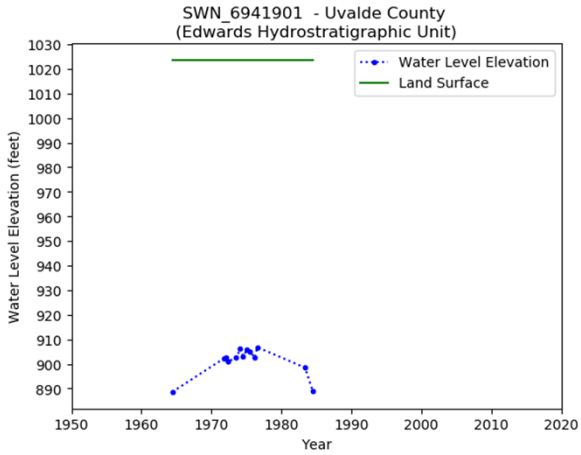
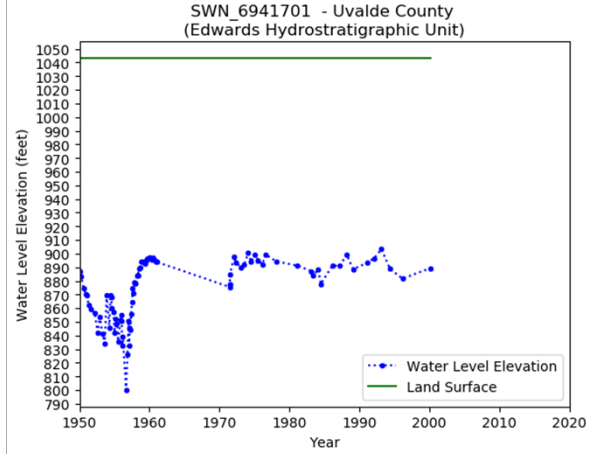
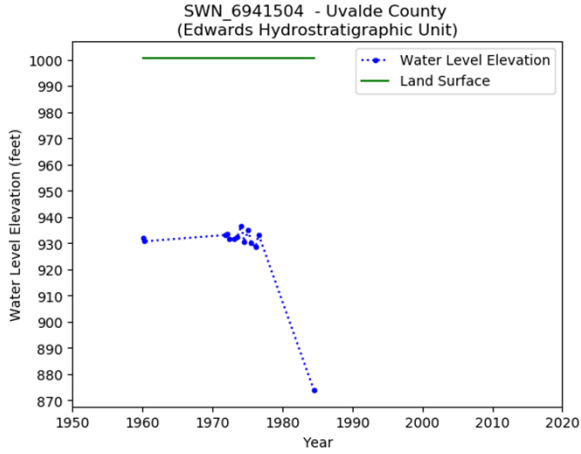

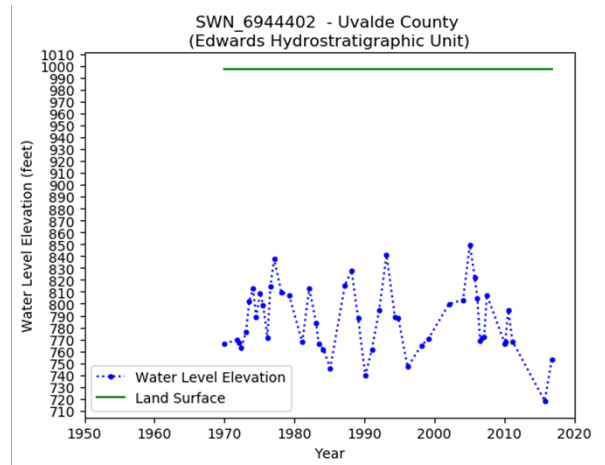
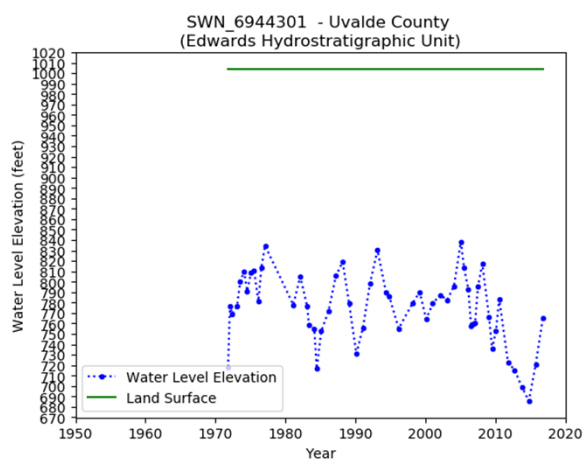
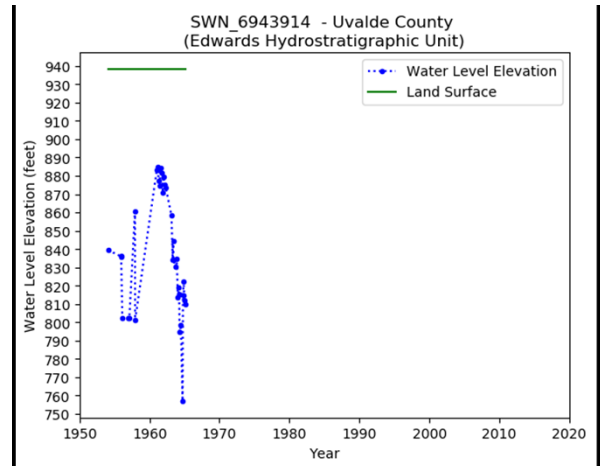
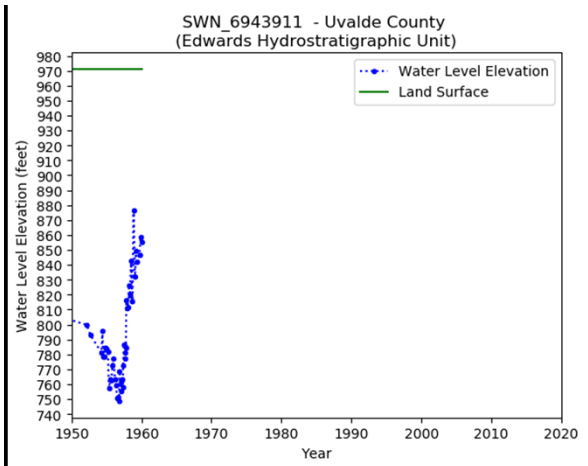
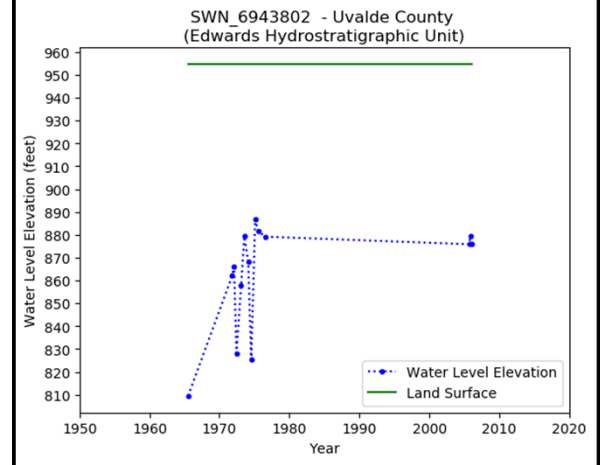
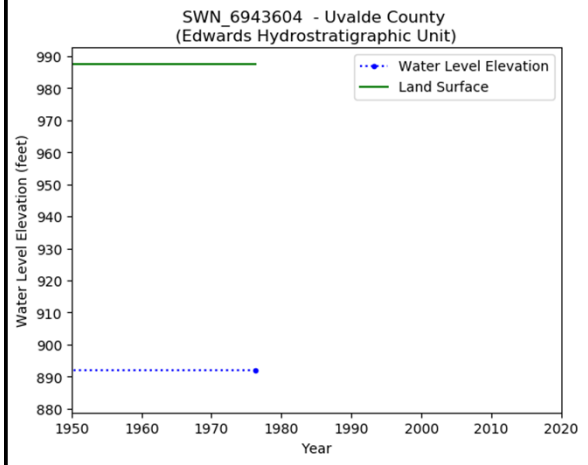

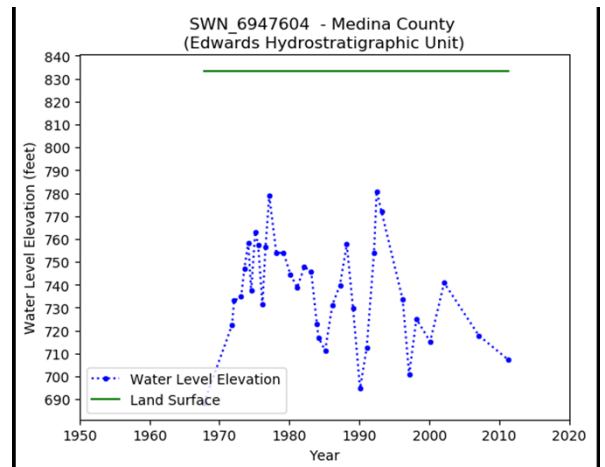
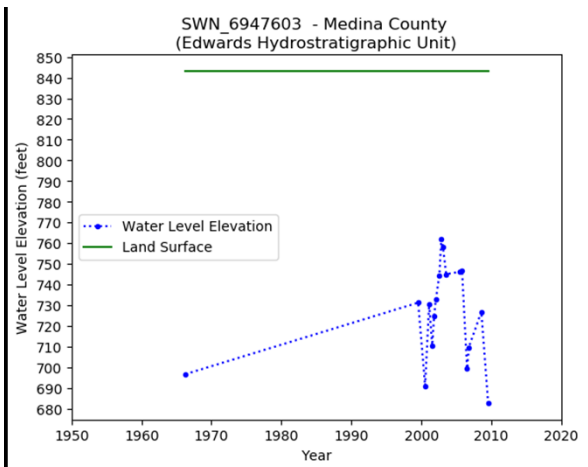
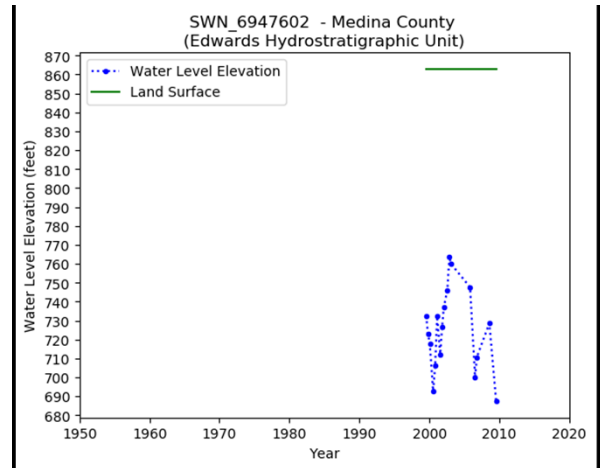
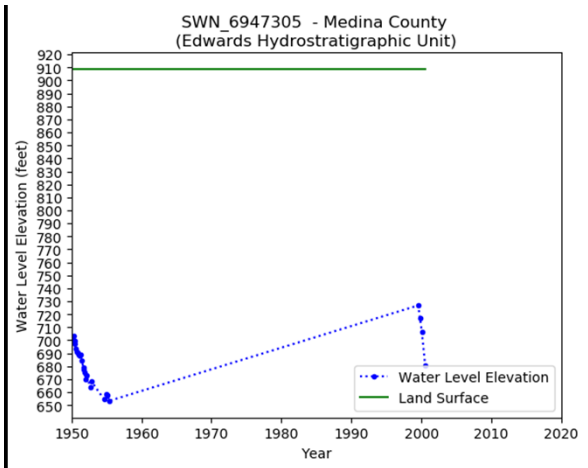
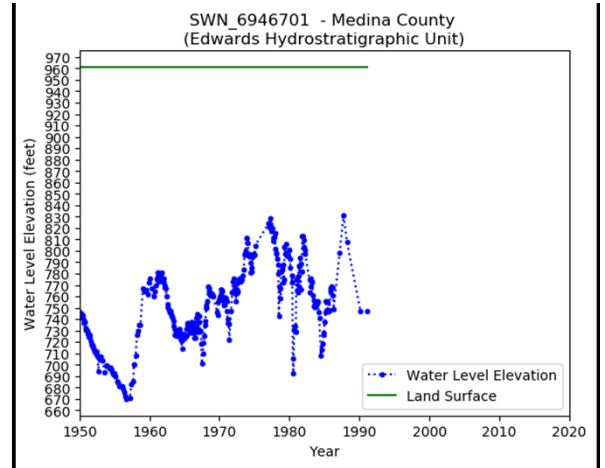
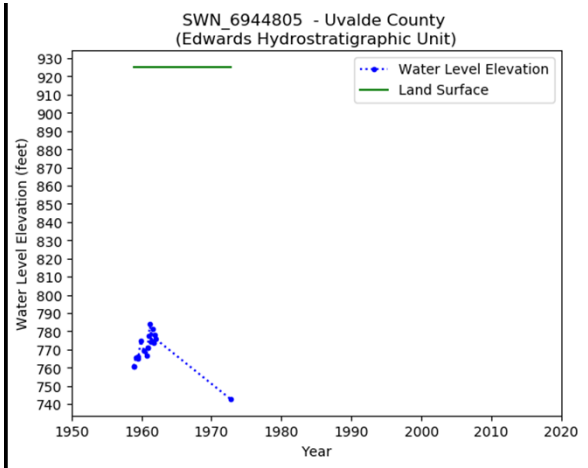

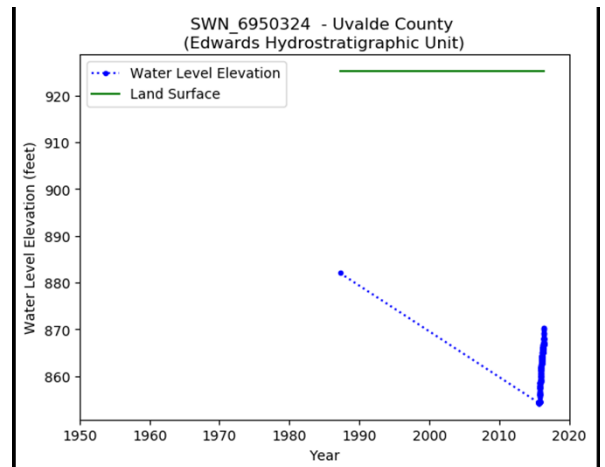
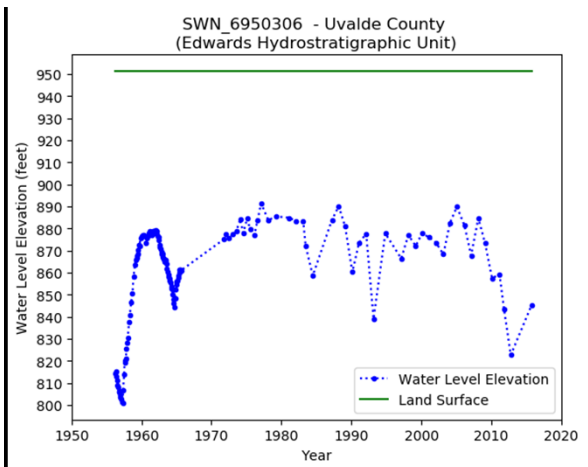
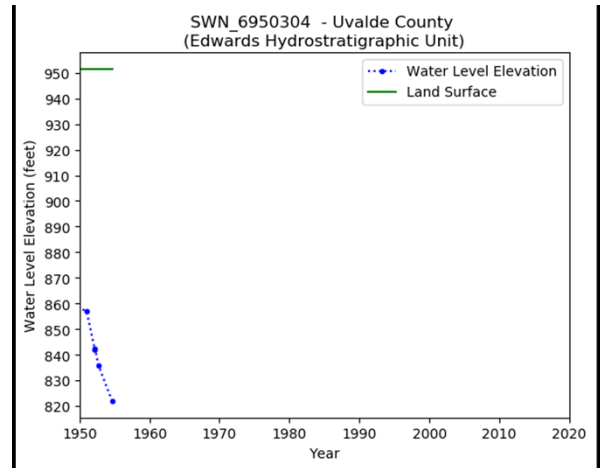
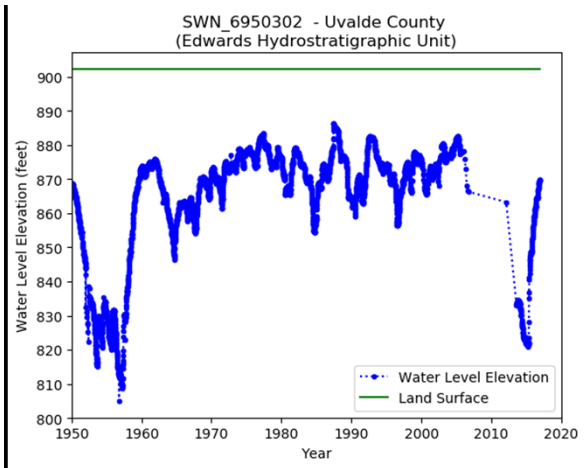
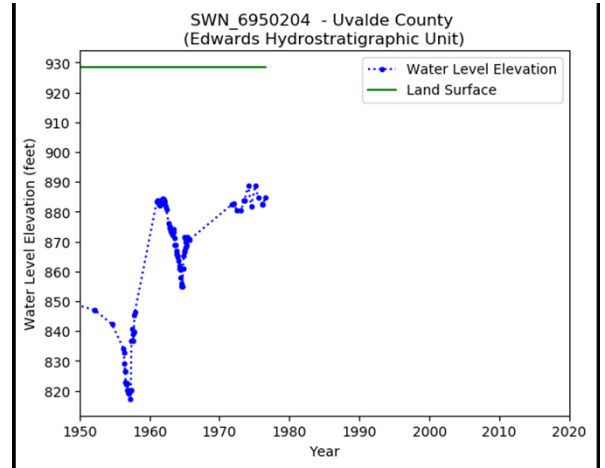
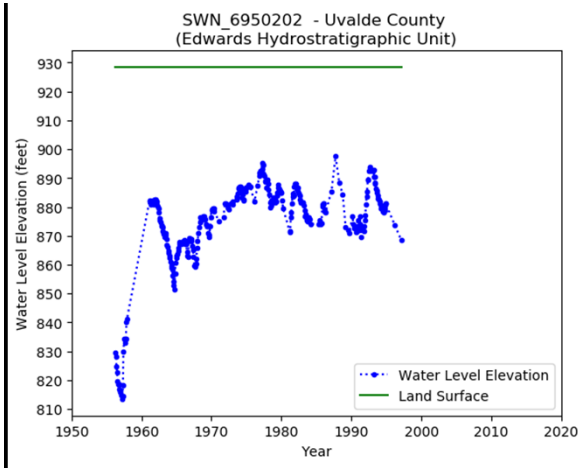

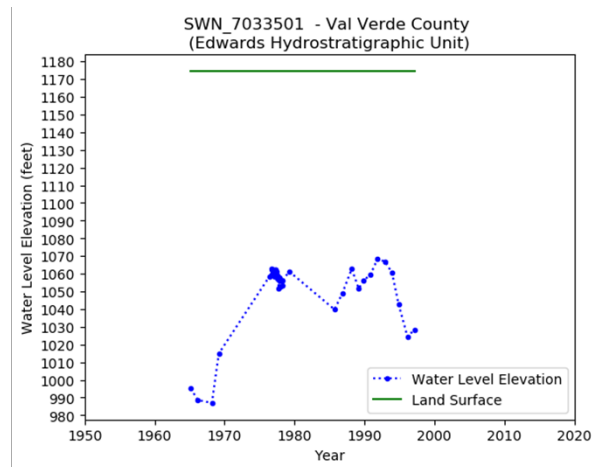
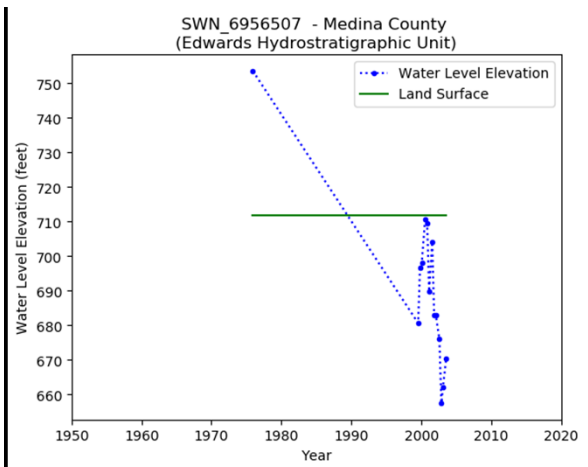
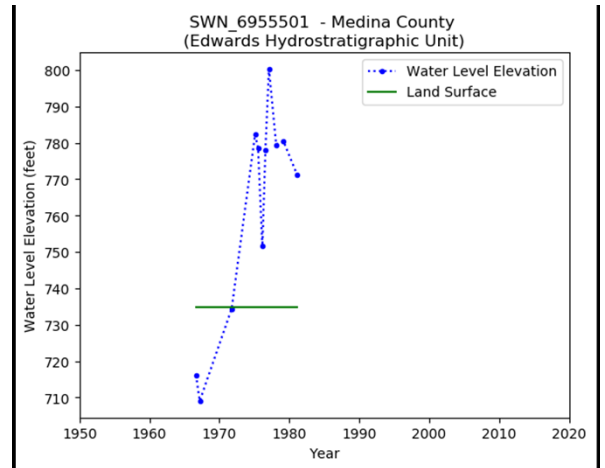
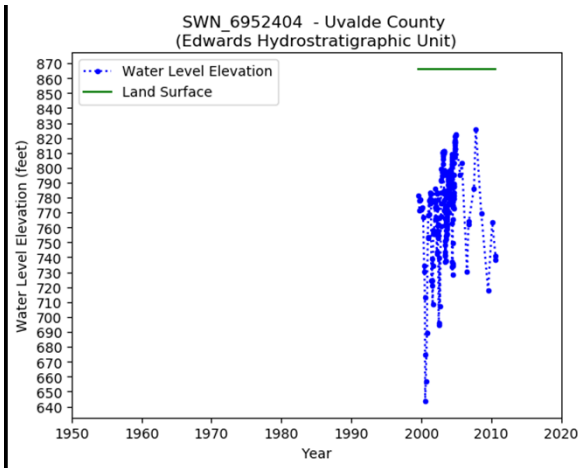
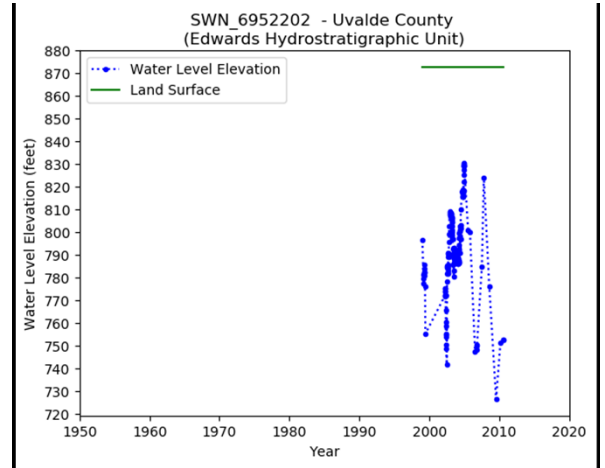
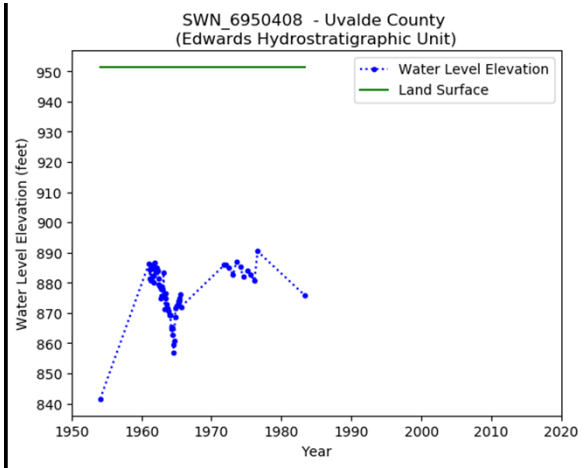

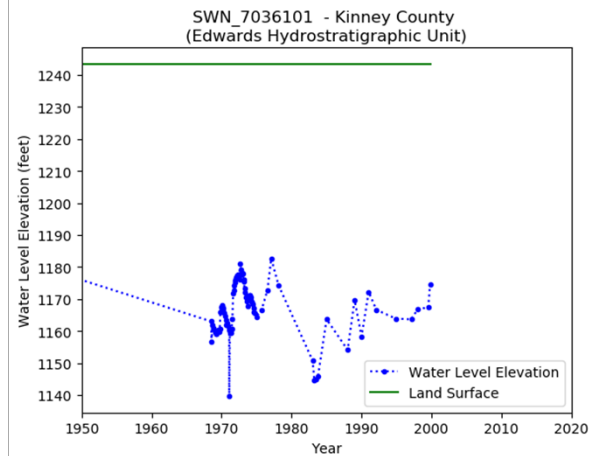
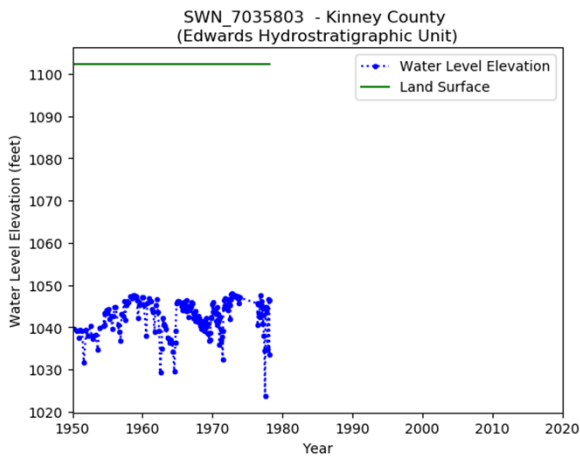
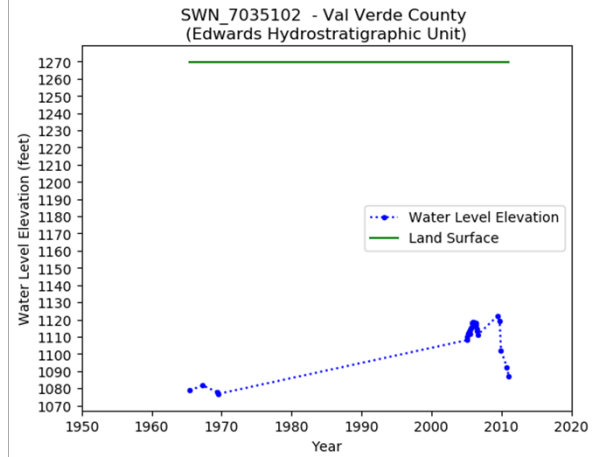
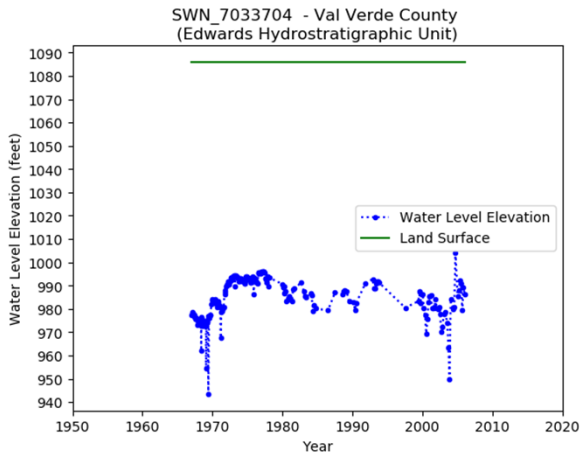
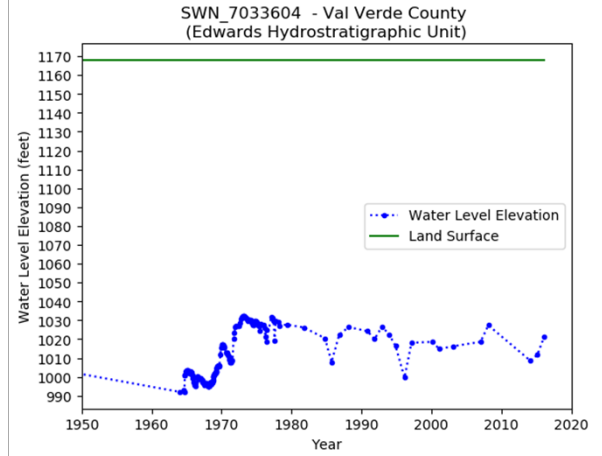
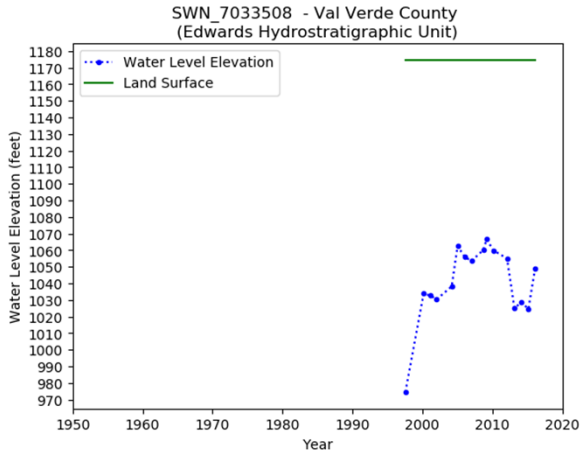

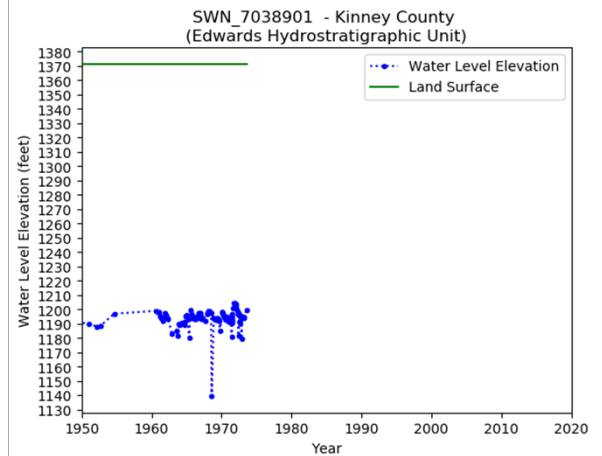
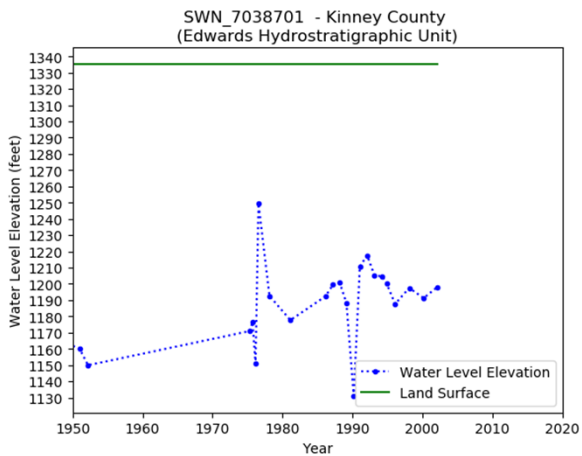
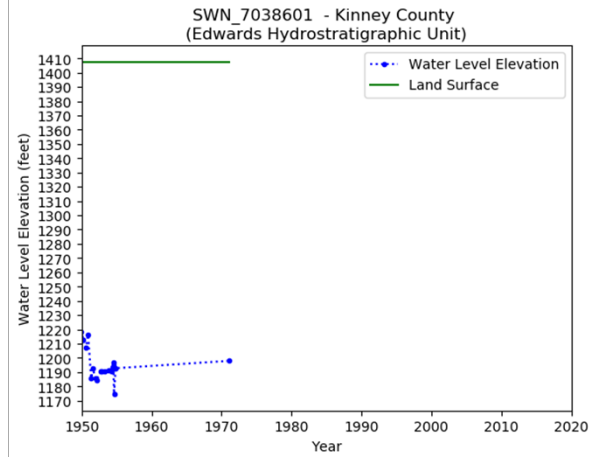
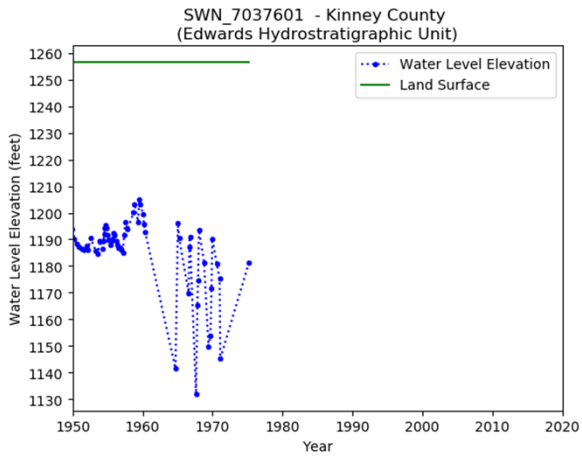
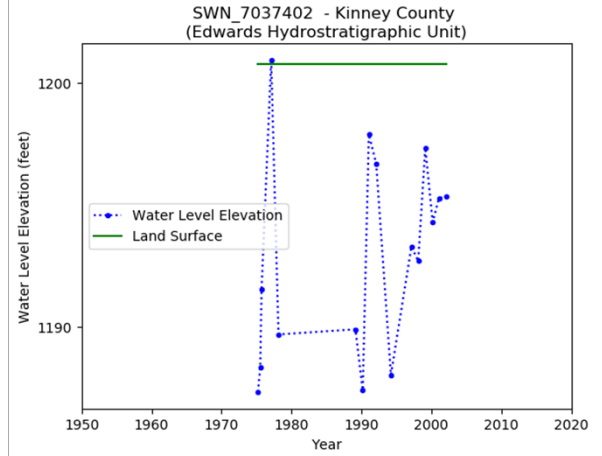
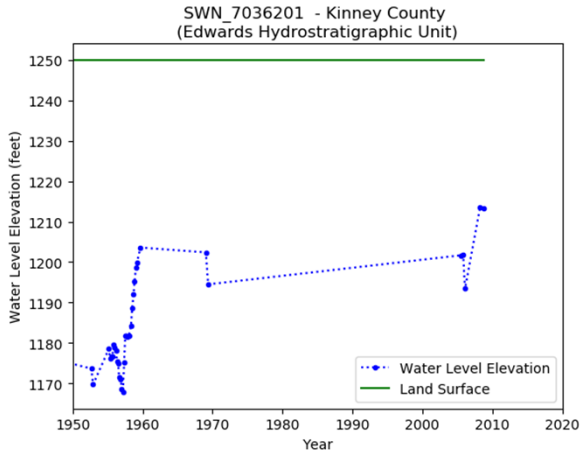

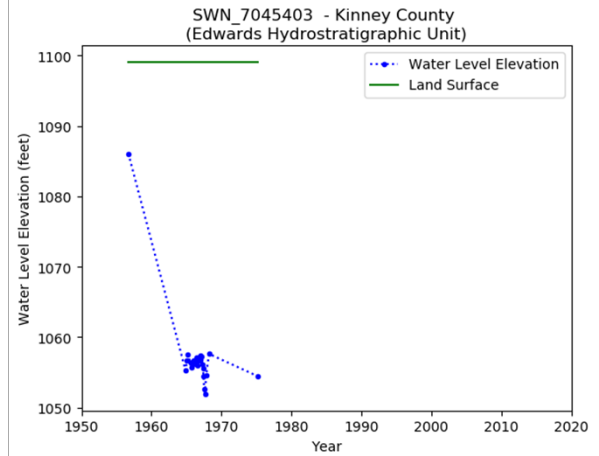
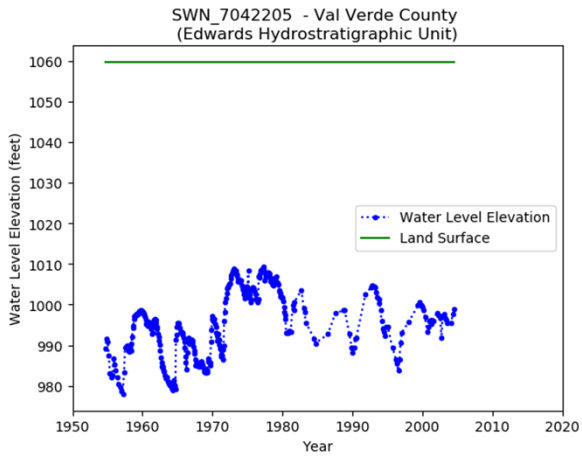
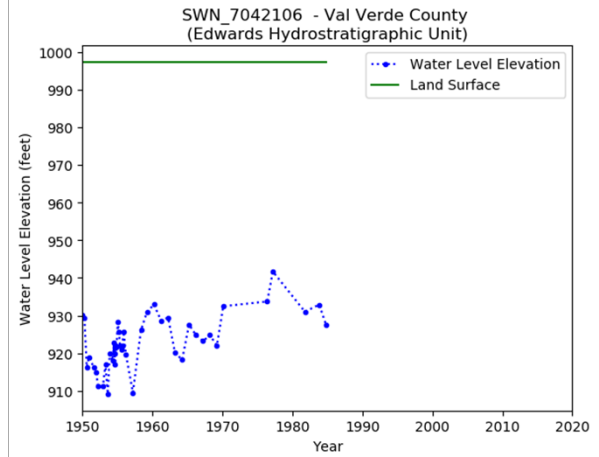
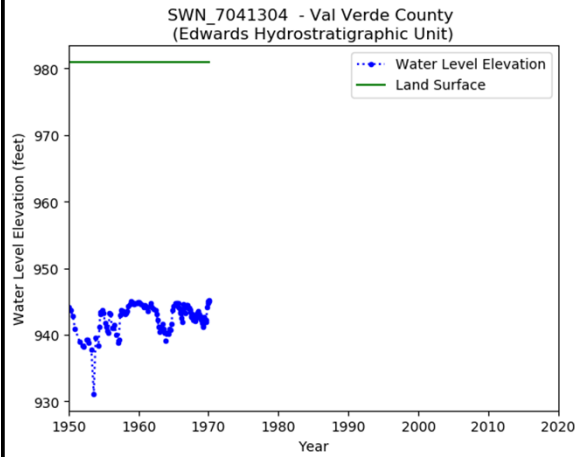
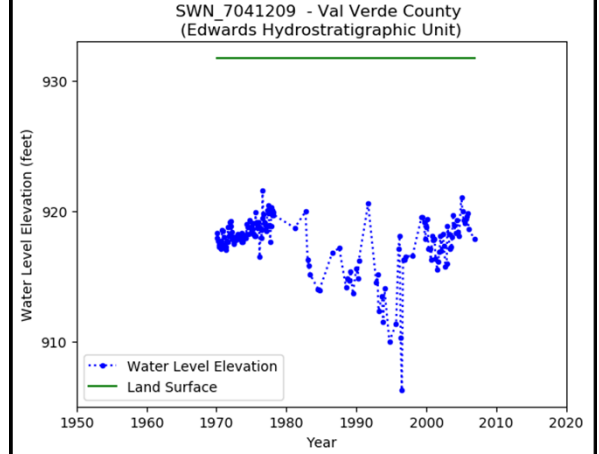
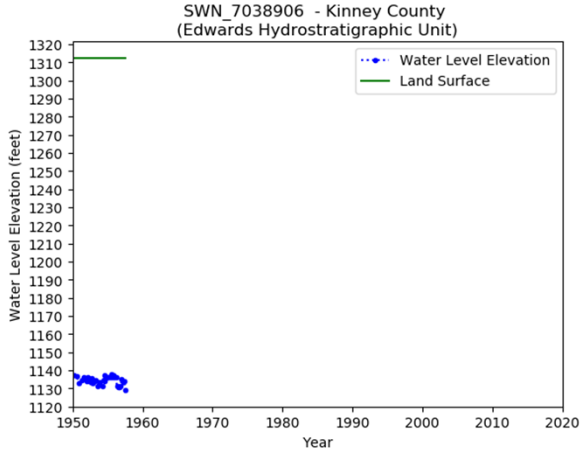

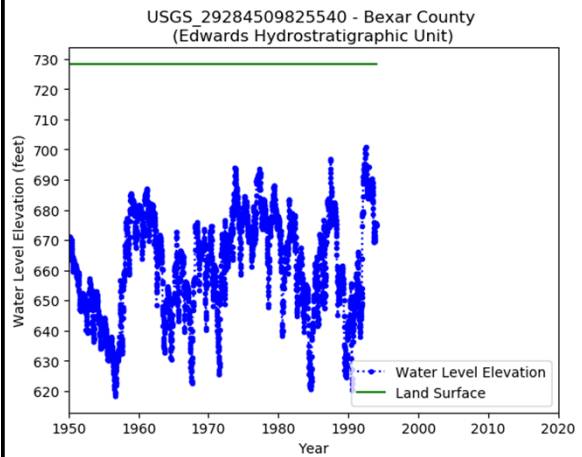
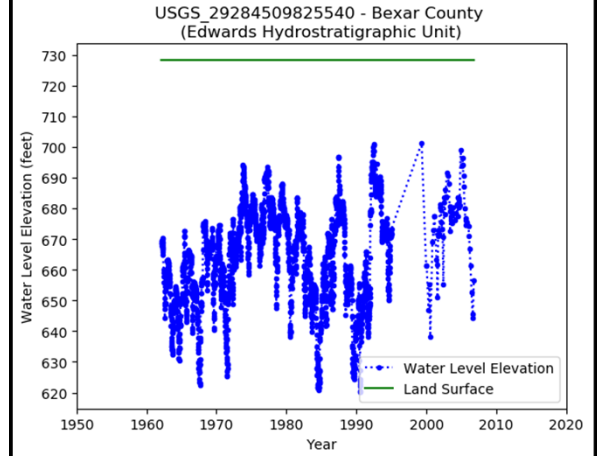
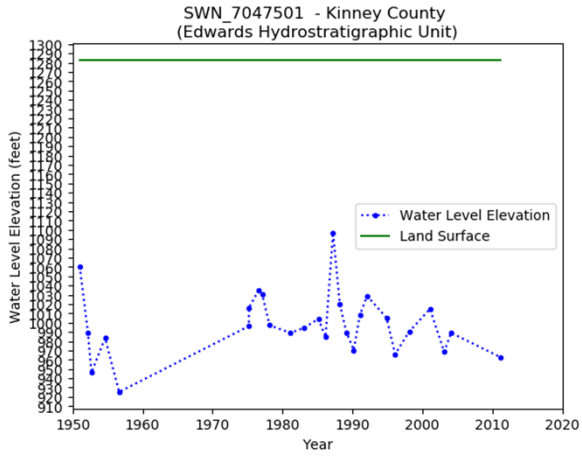

Upper Trinity Hydrographs

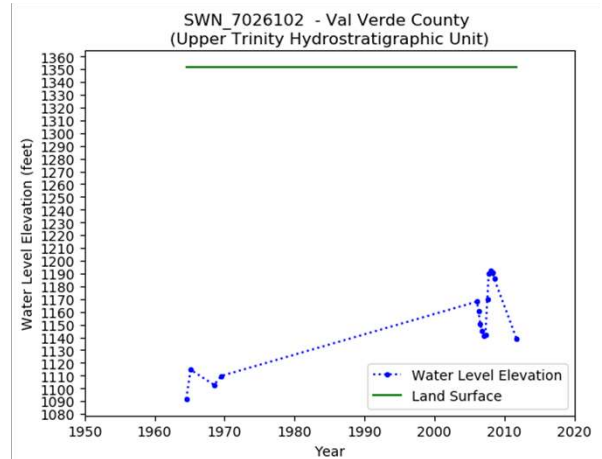
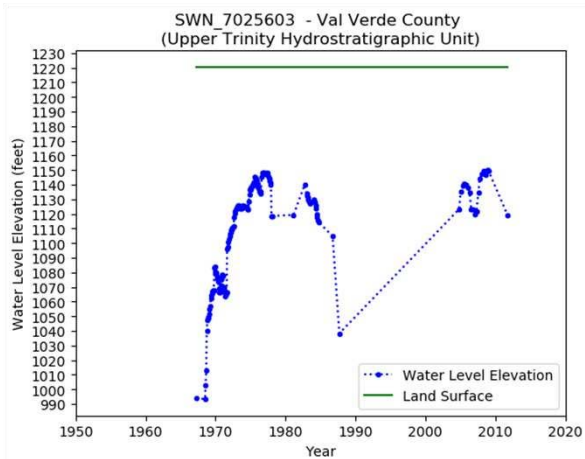
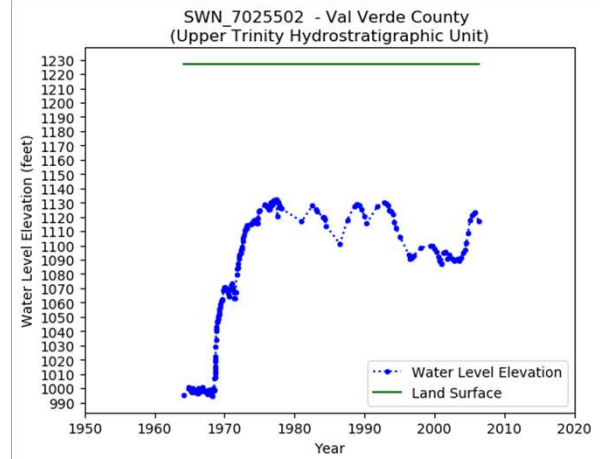
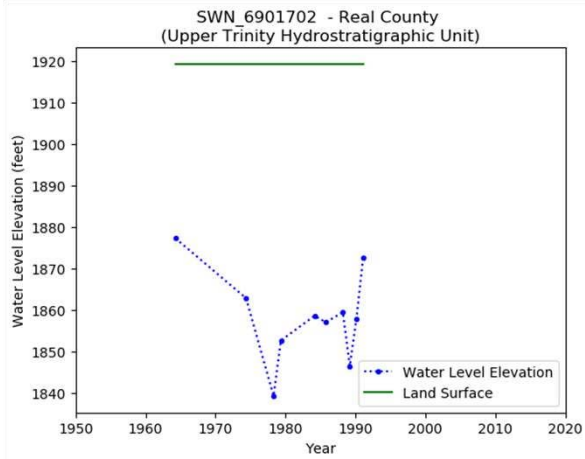
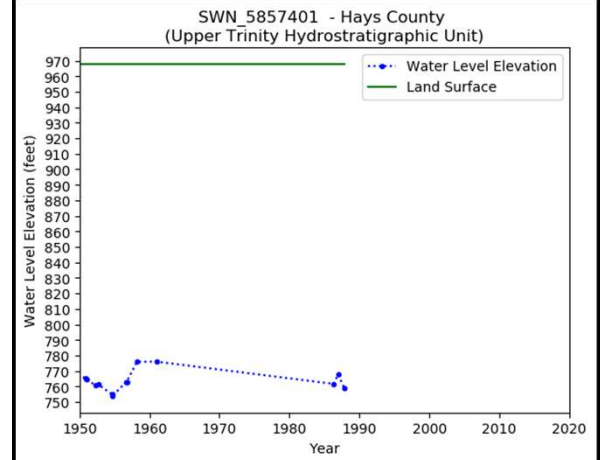
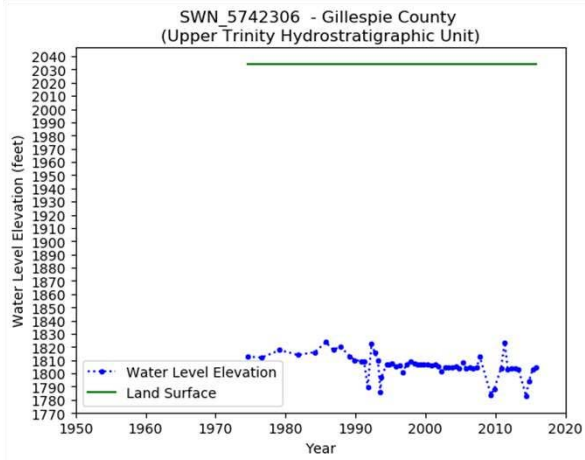

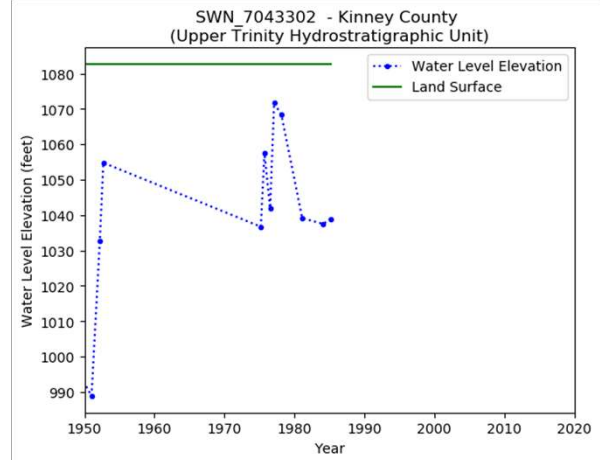
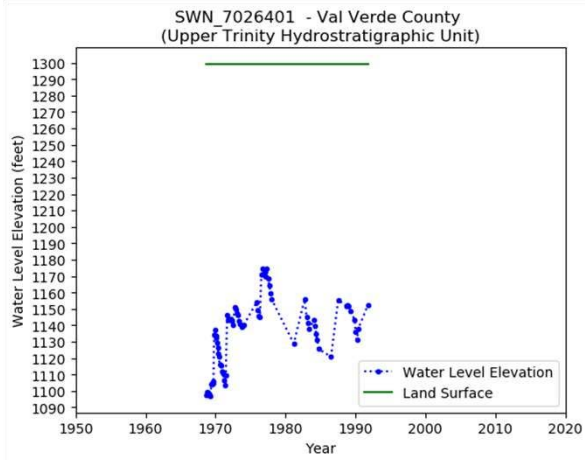

Middle Trinity Hydrographs

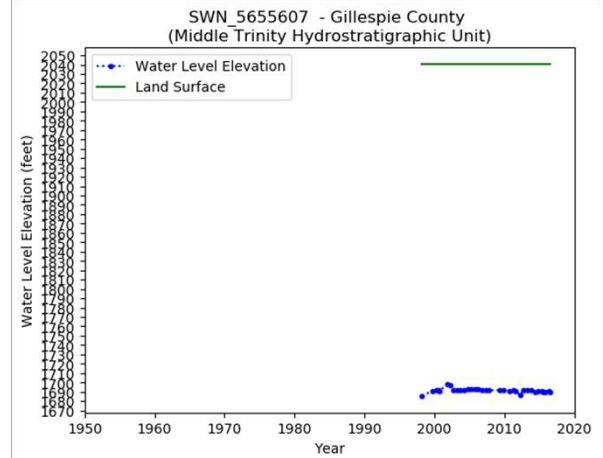
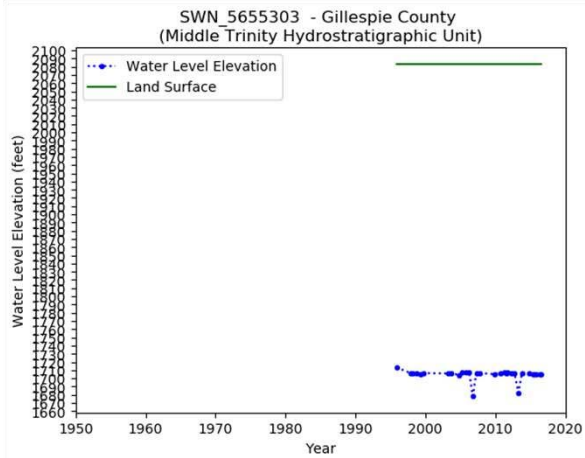
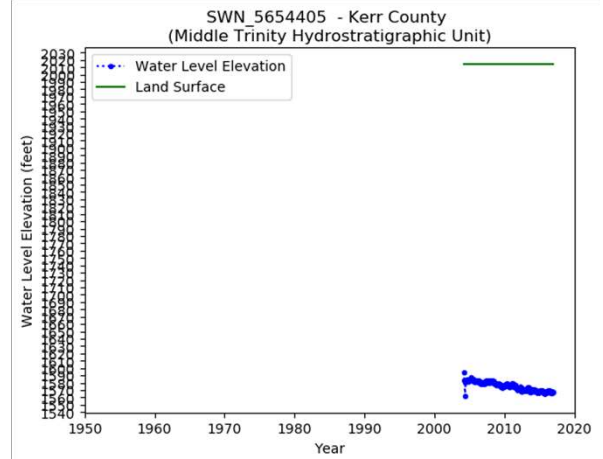
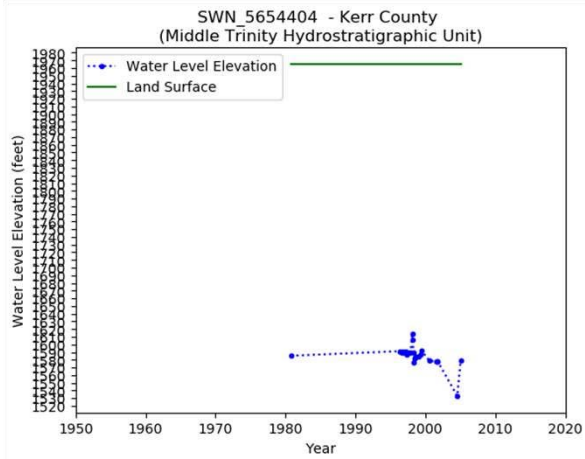
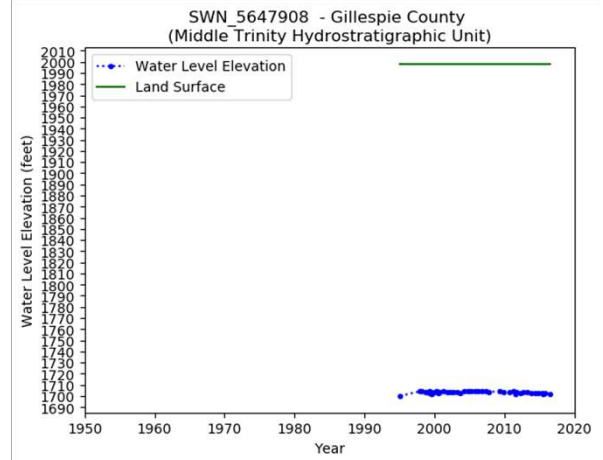
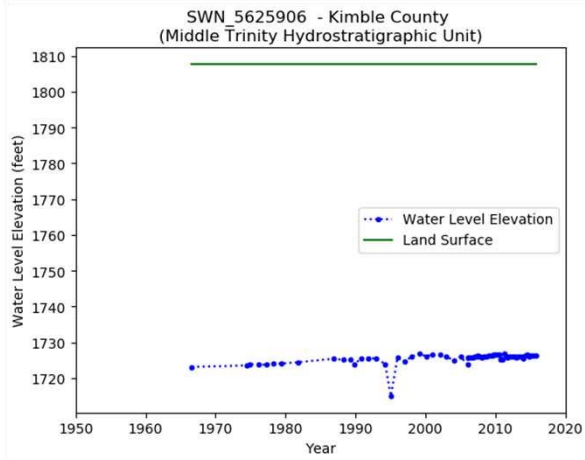

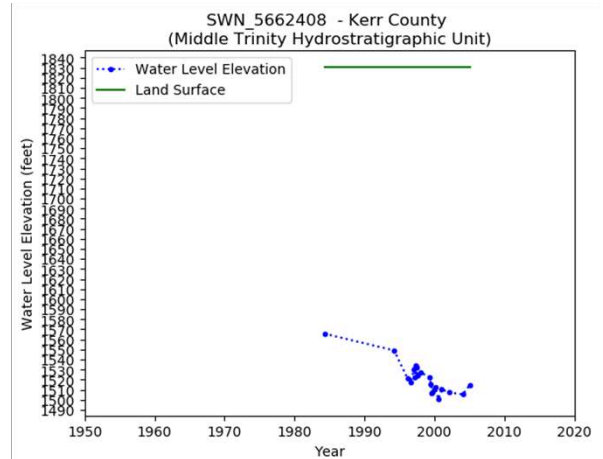
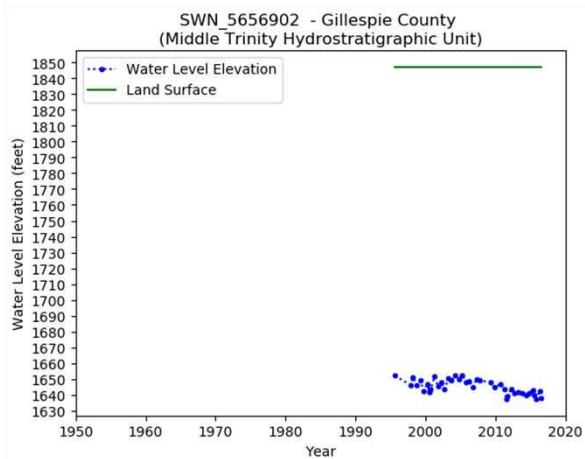
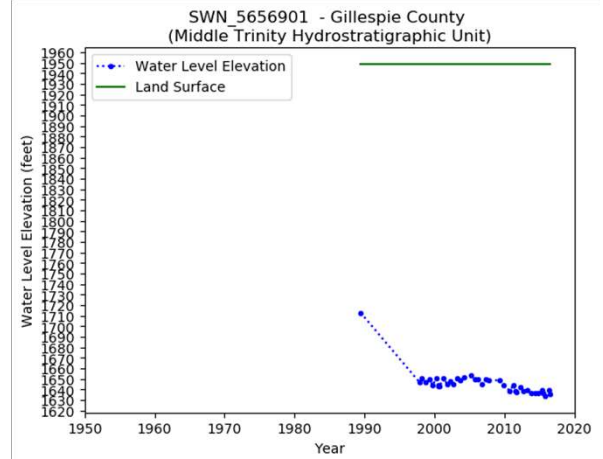
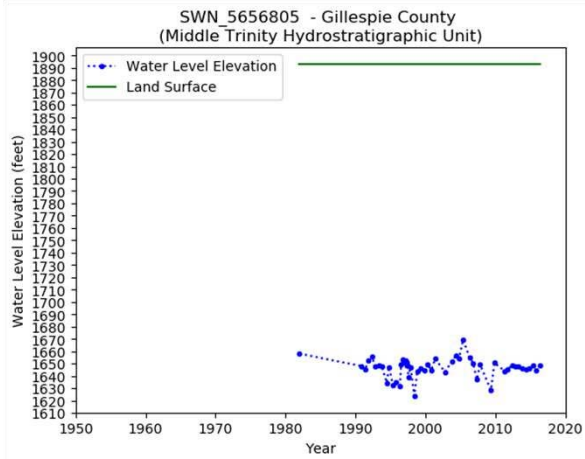
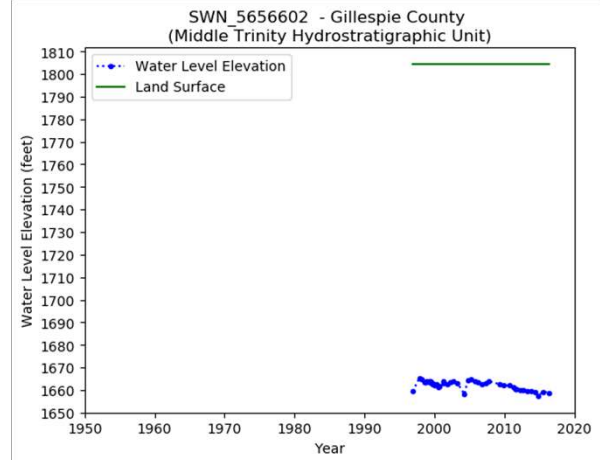
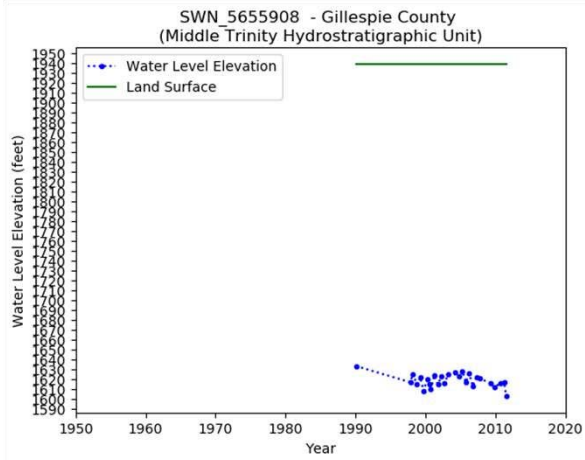

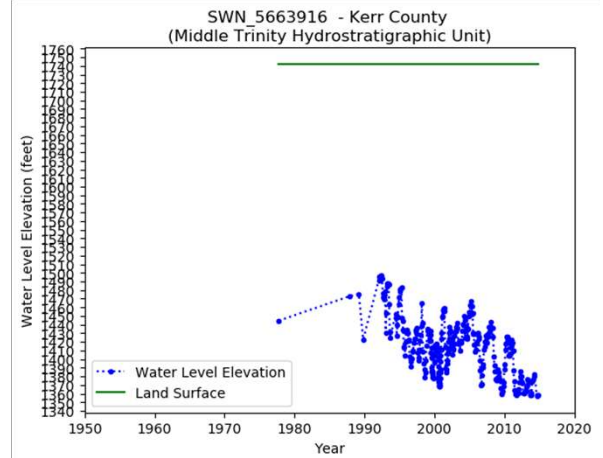
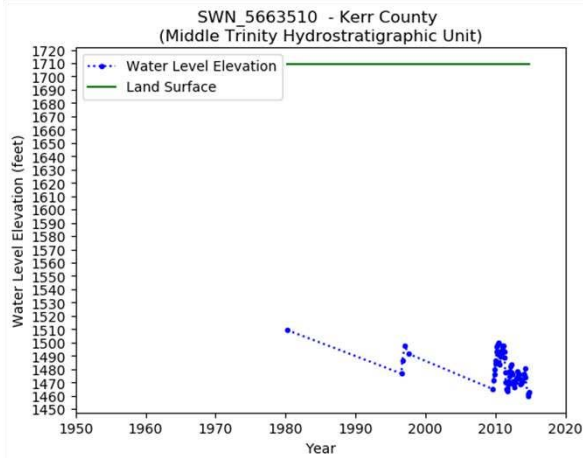
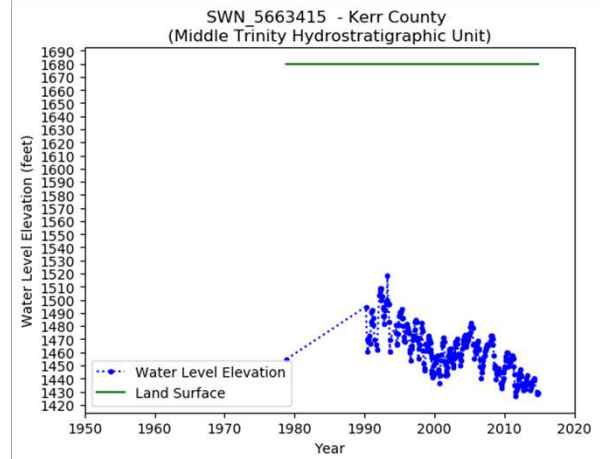
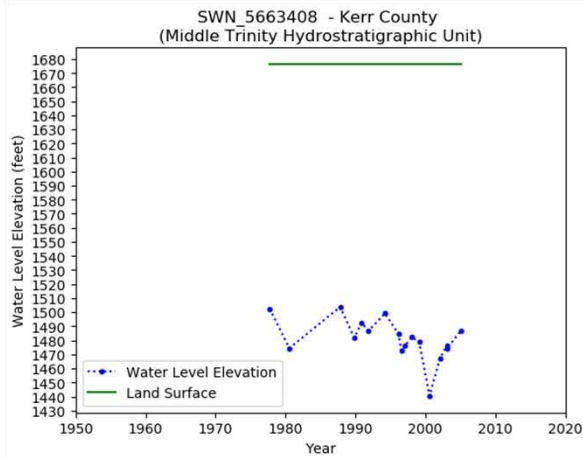
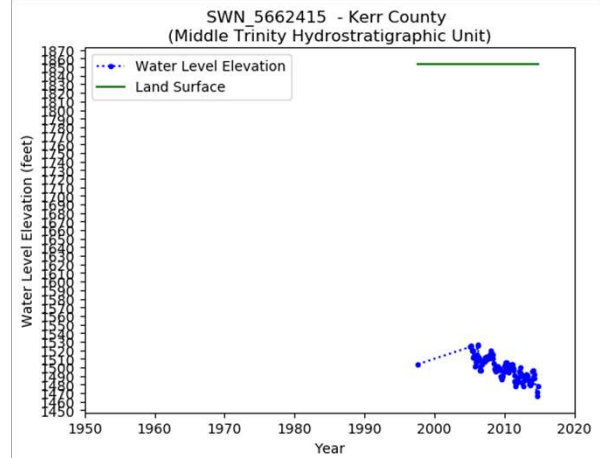
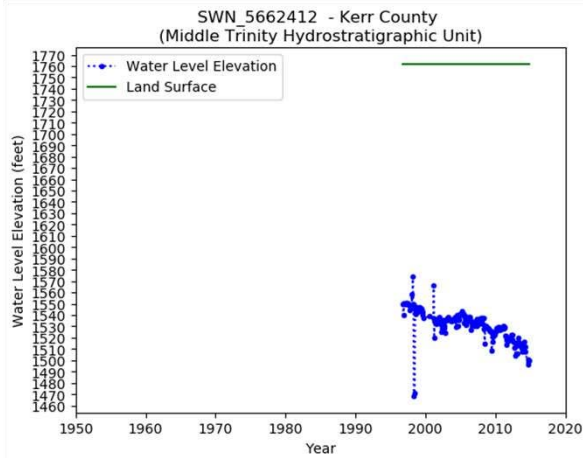

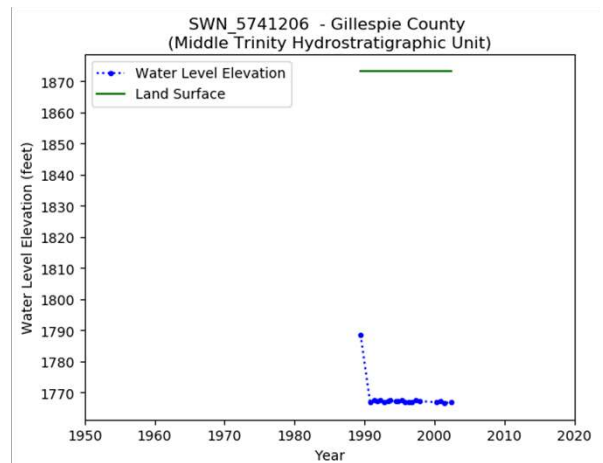
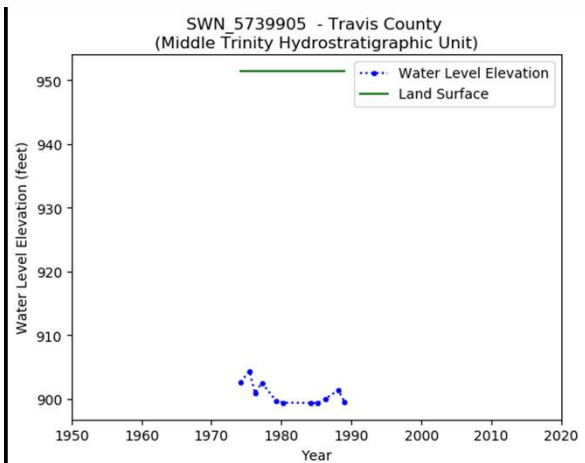
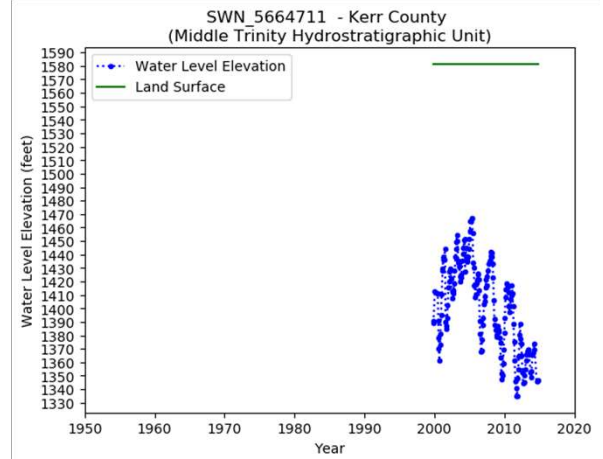
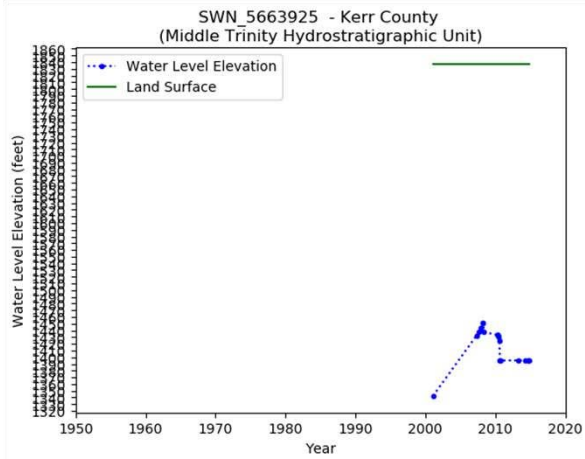
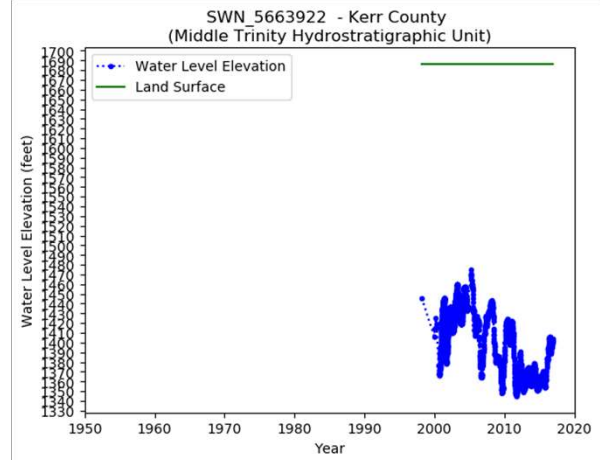
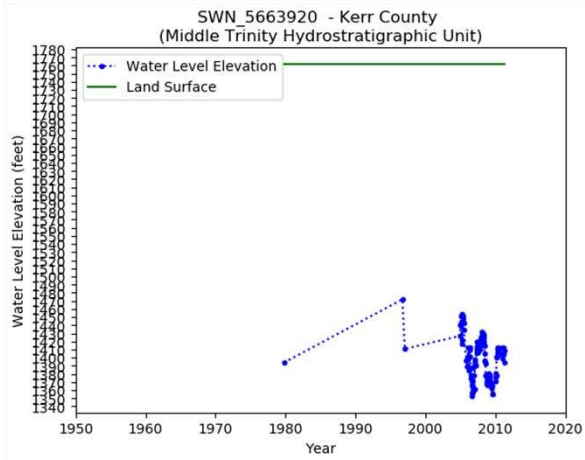

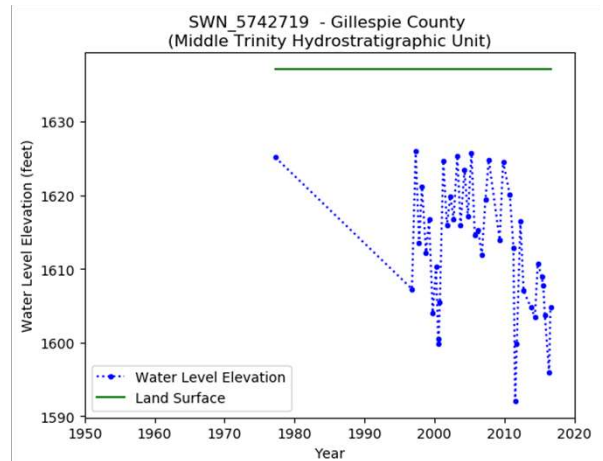
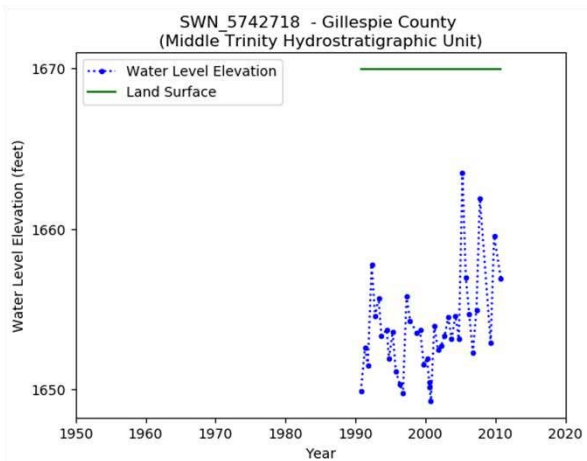
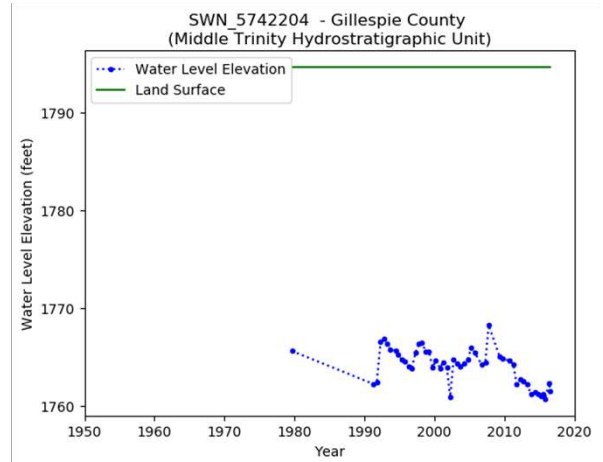
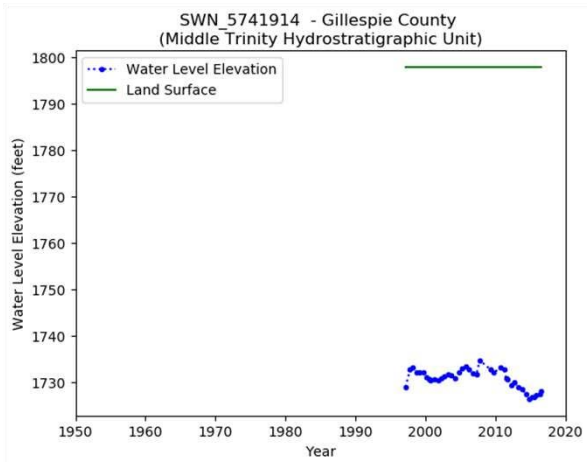
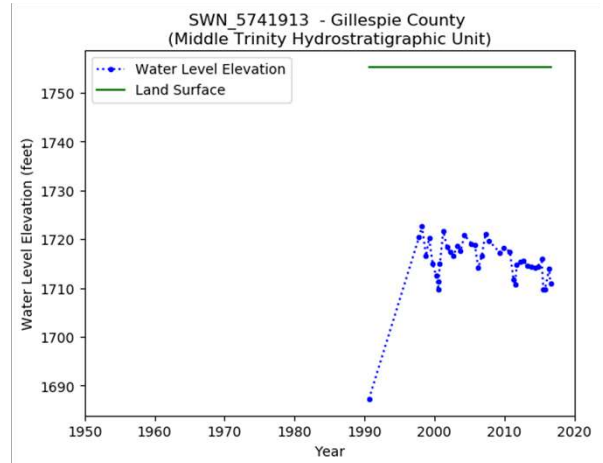
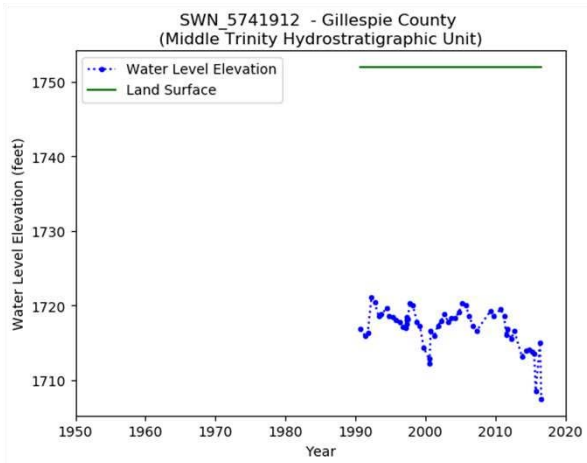

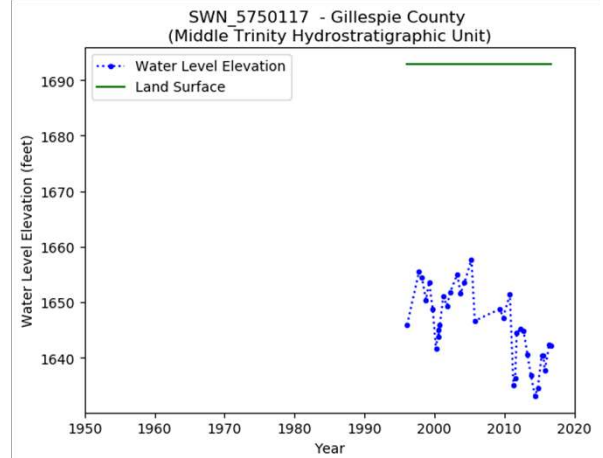
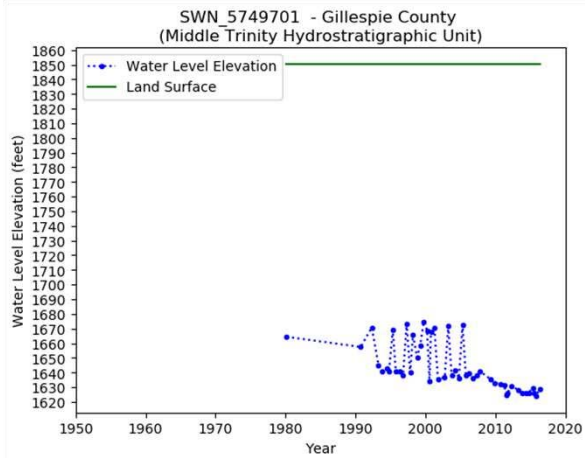
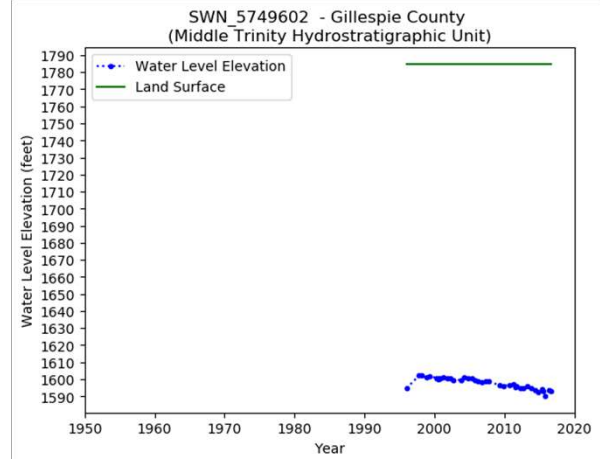
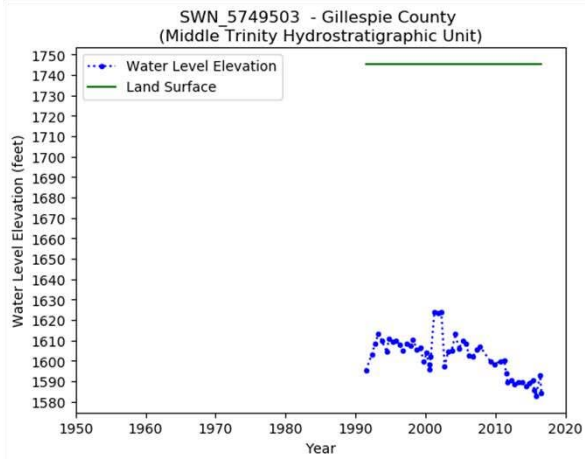
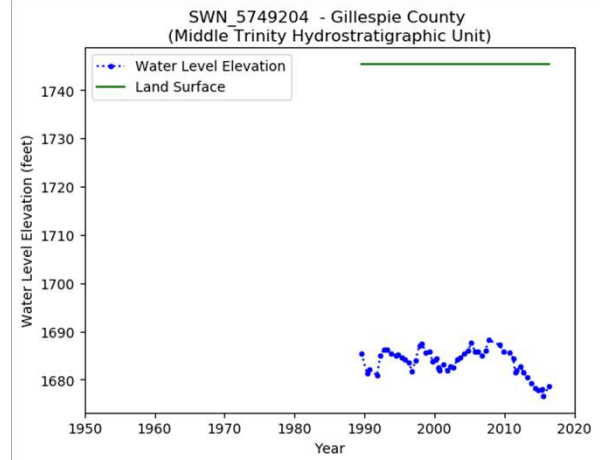
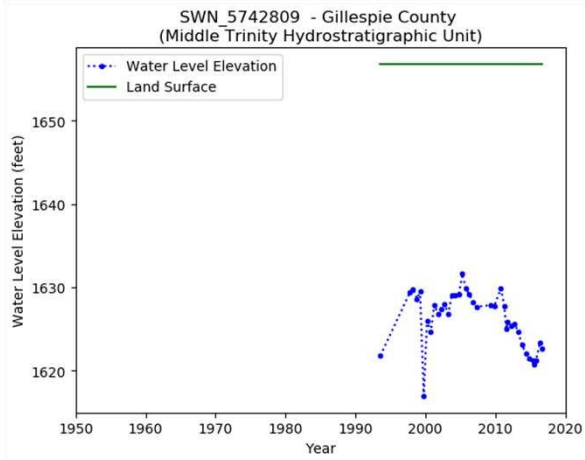

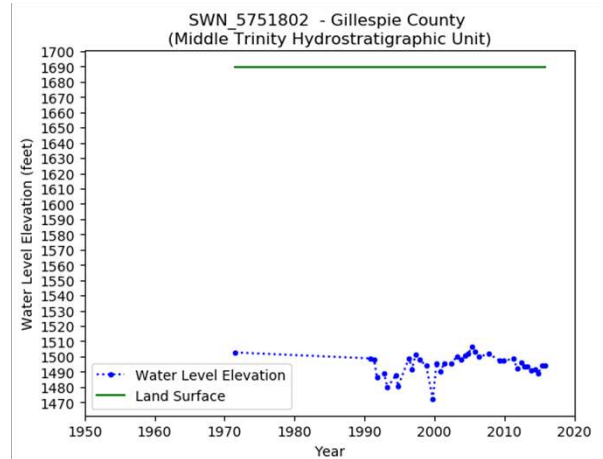
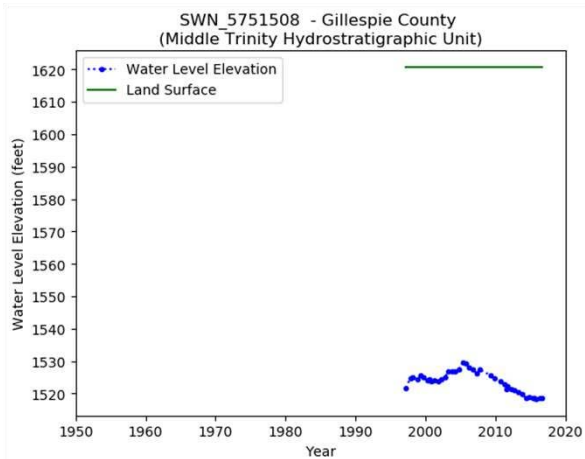
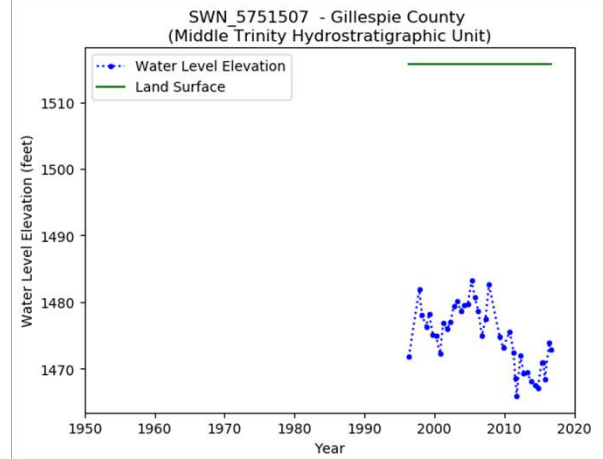
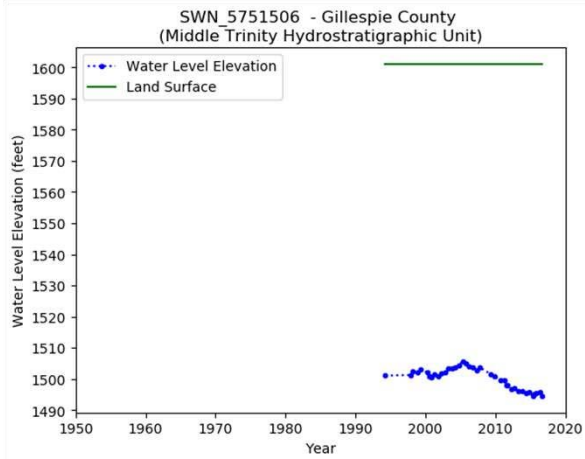
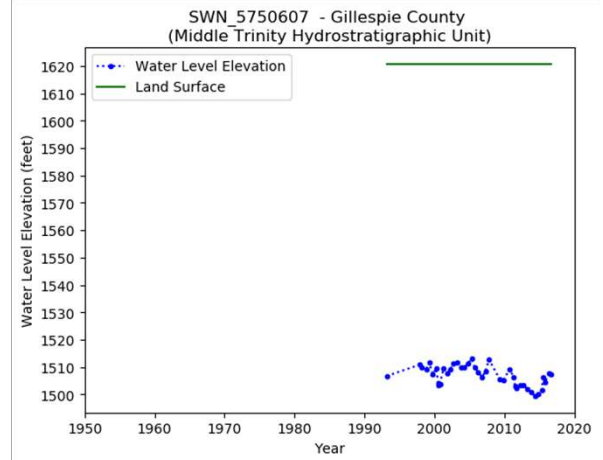
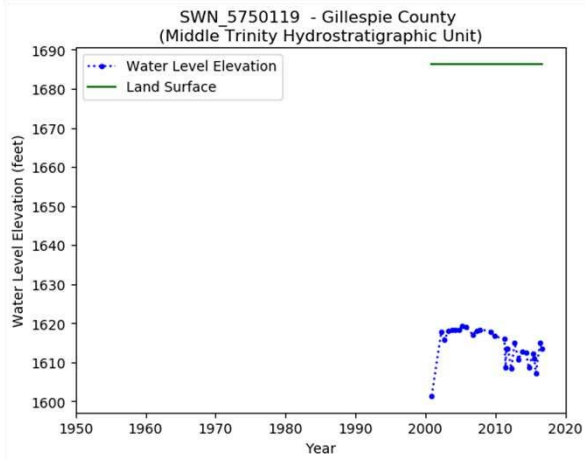

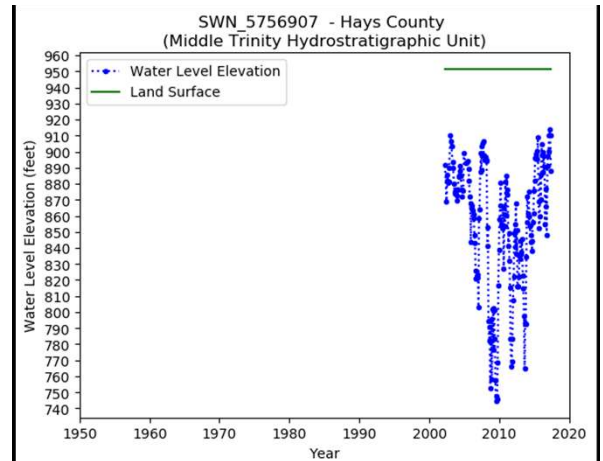
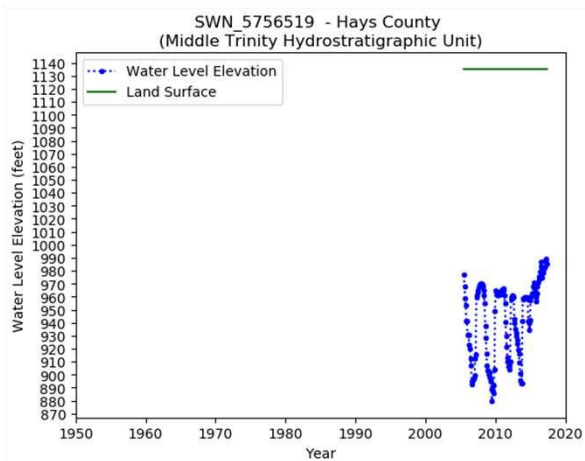
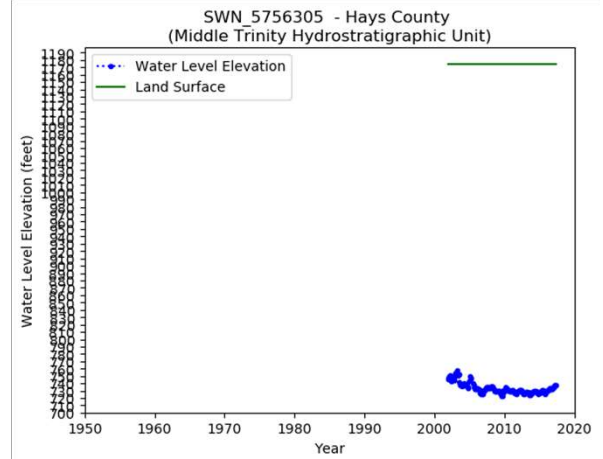
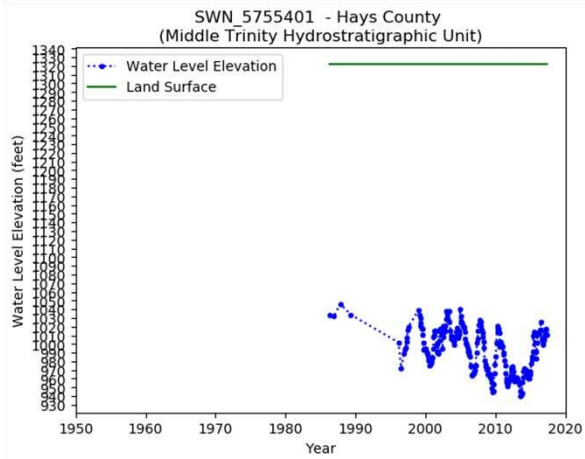
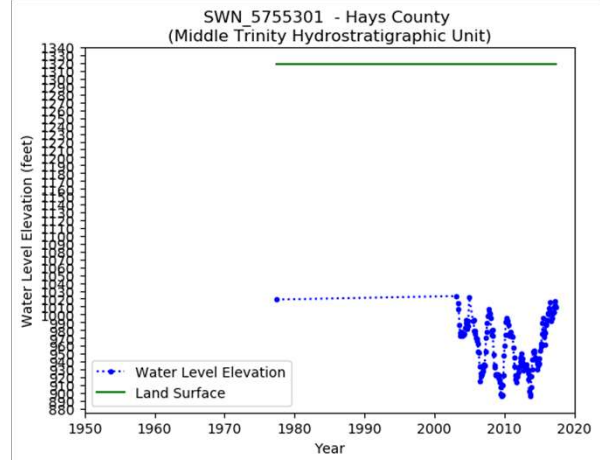
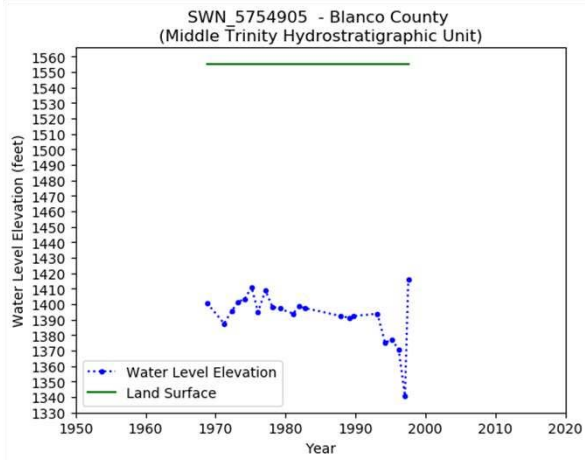

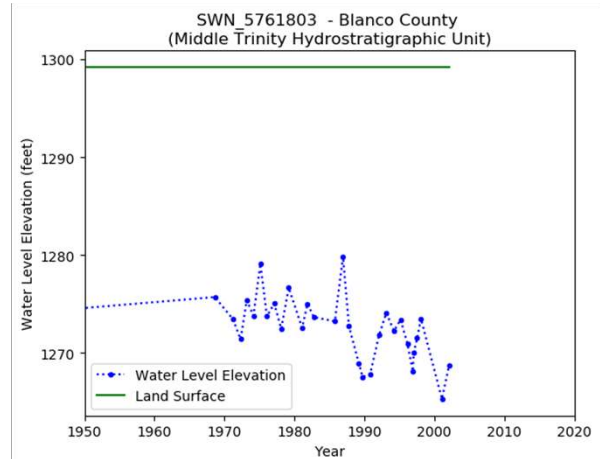
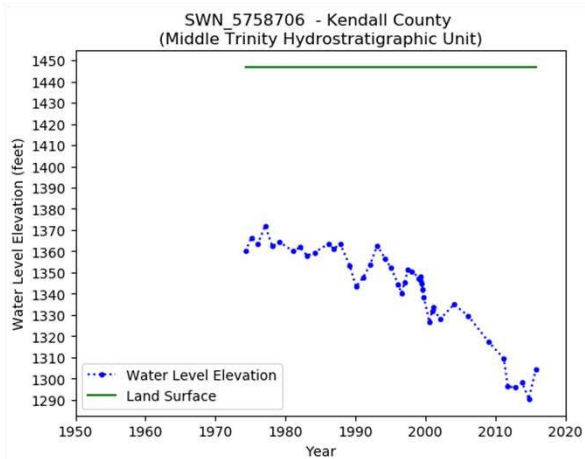
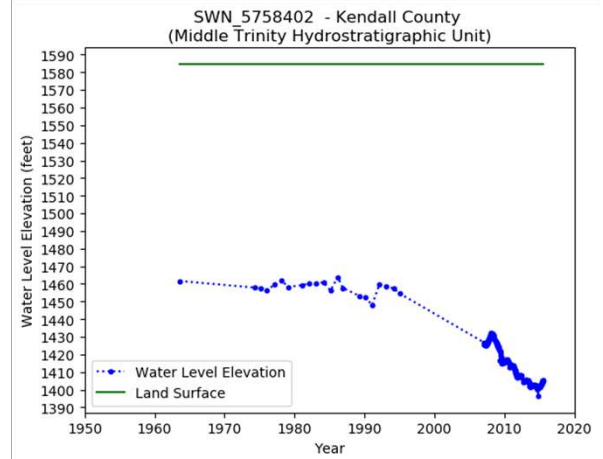
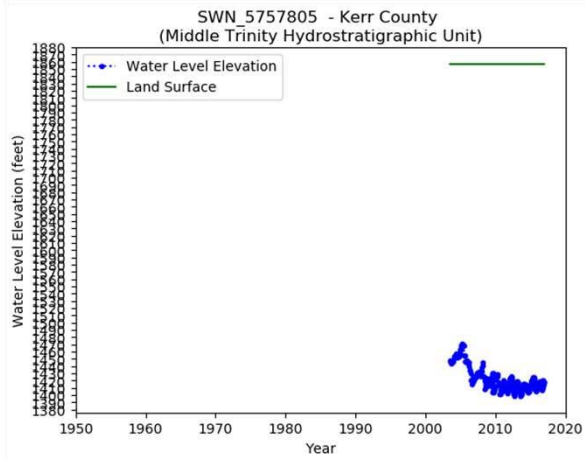
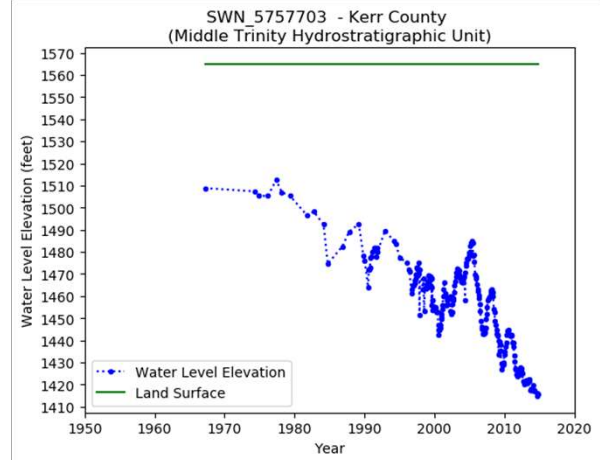
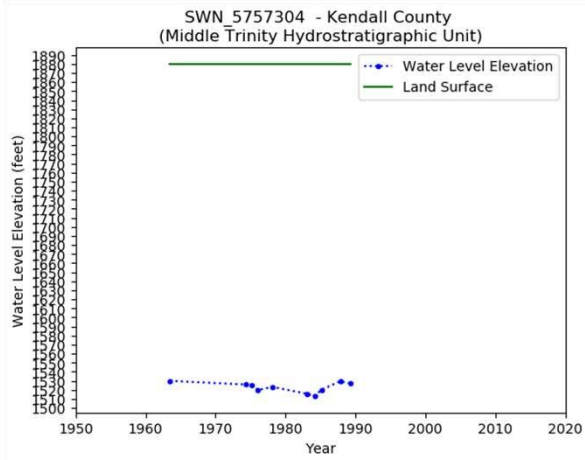

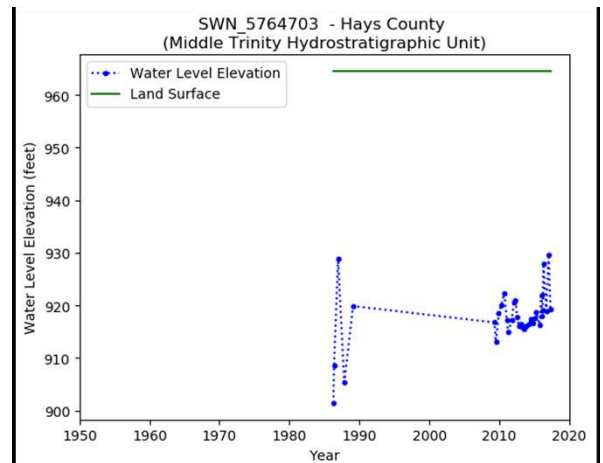
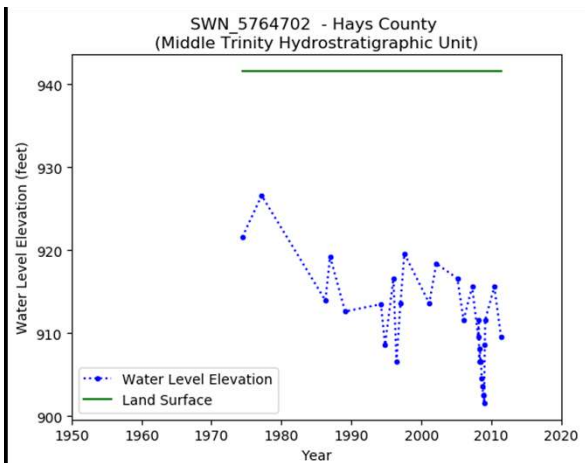
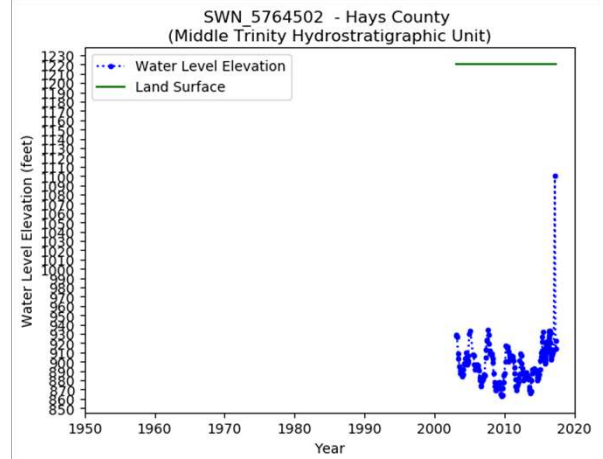
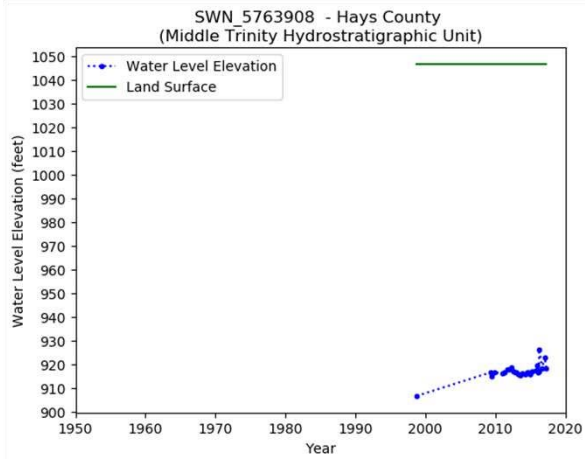
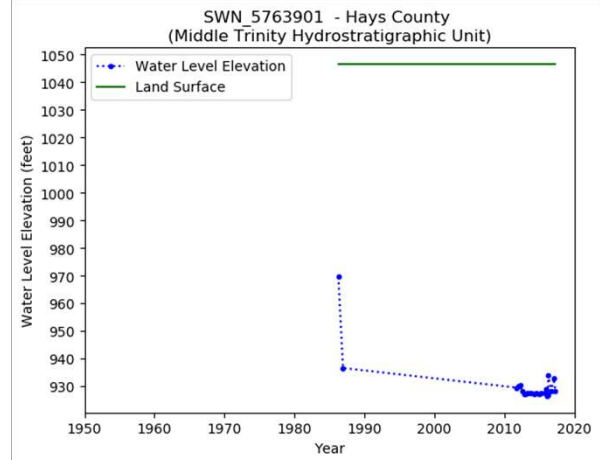
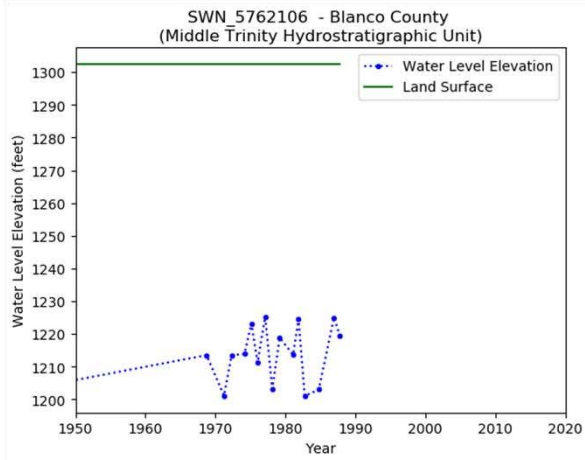

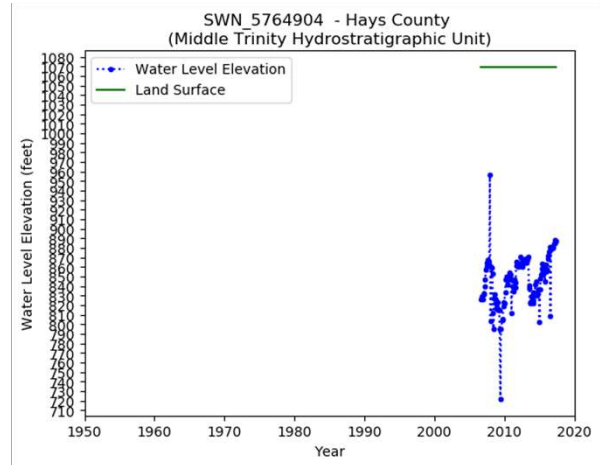
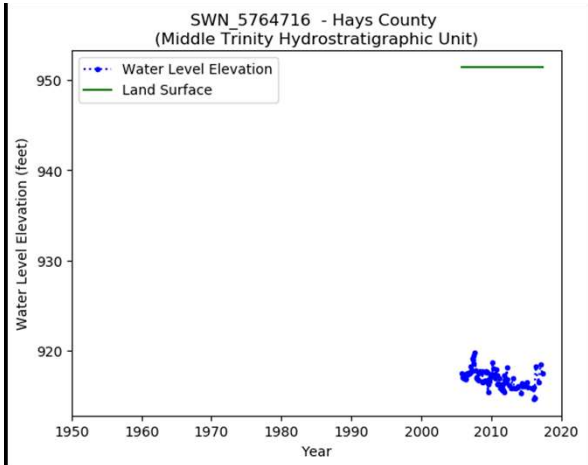
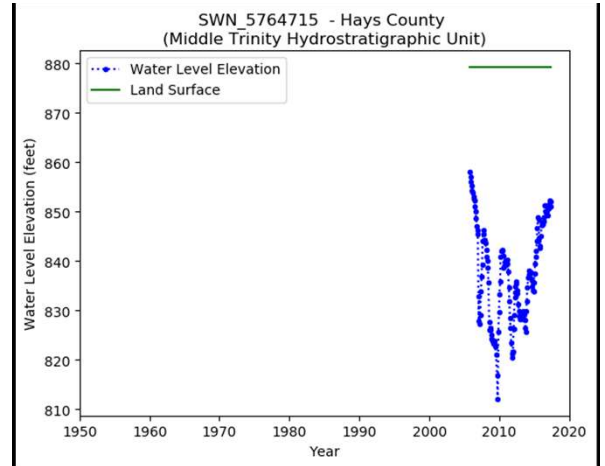
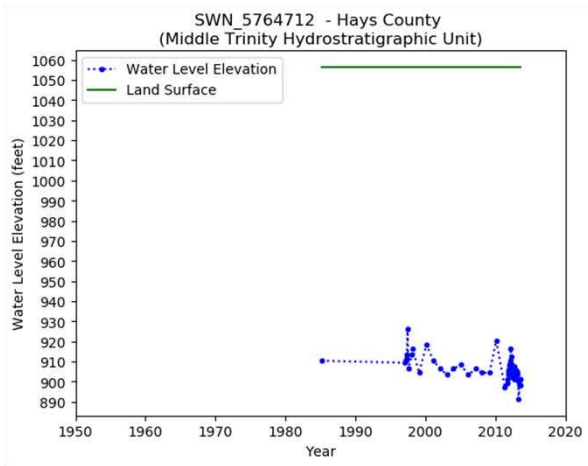
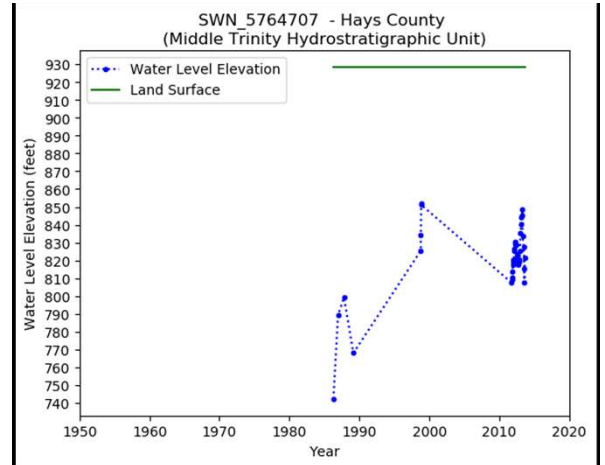
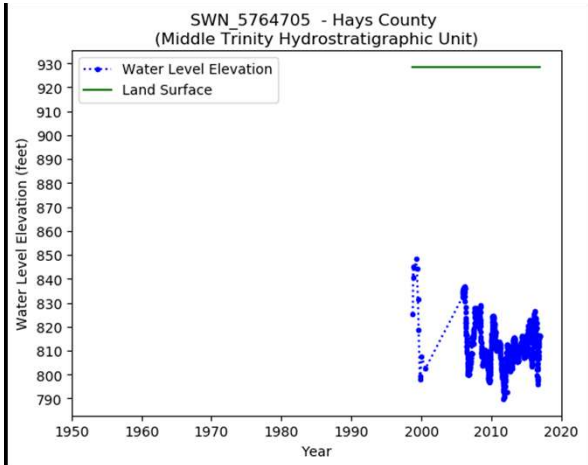

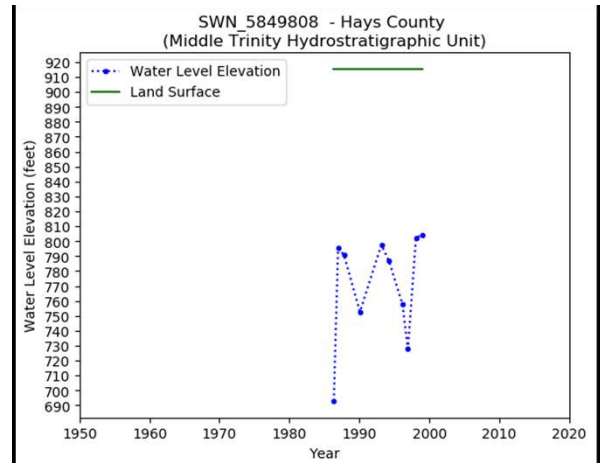
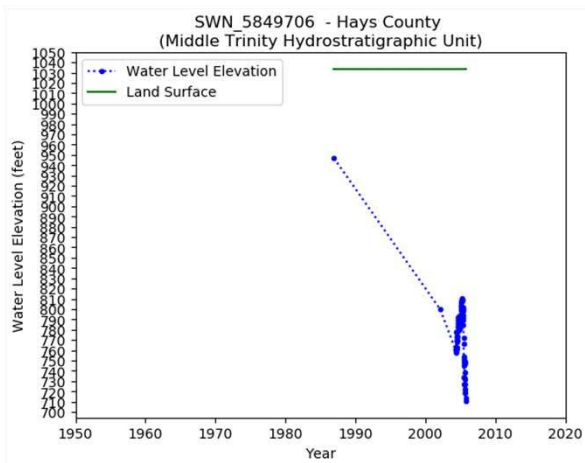
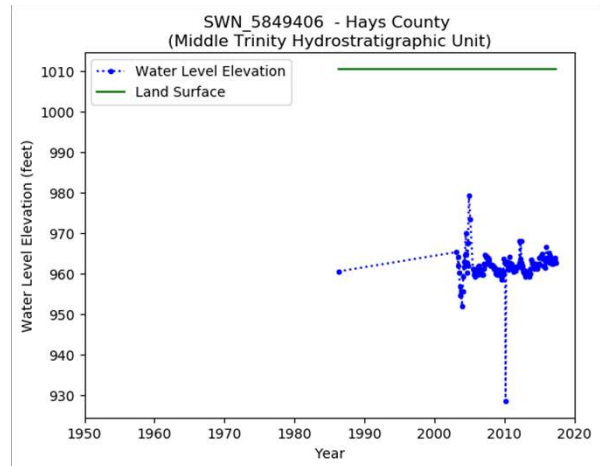
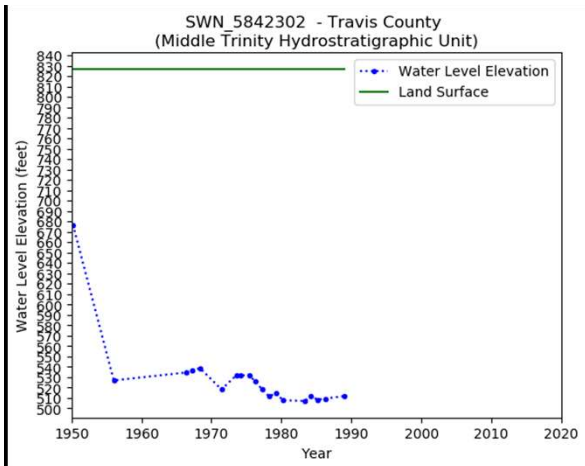
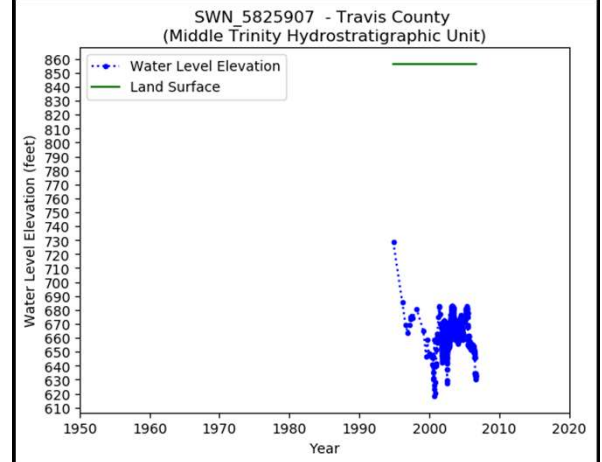
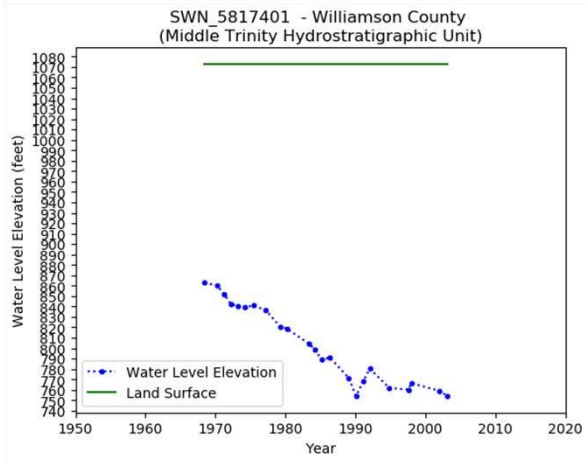

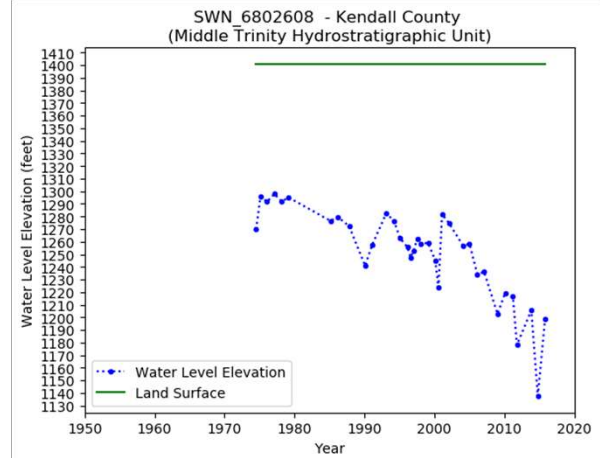
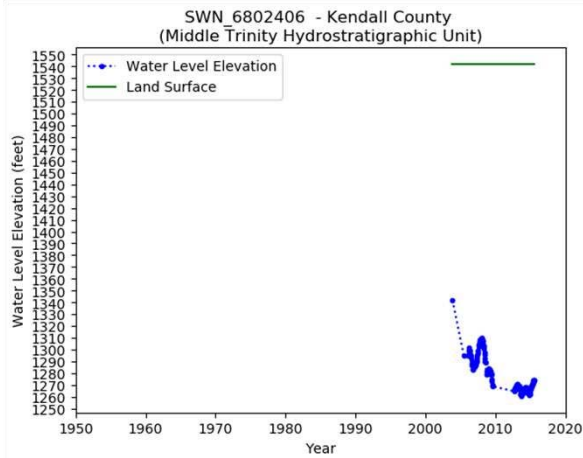
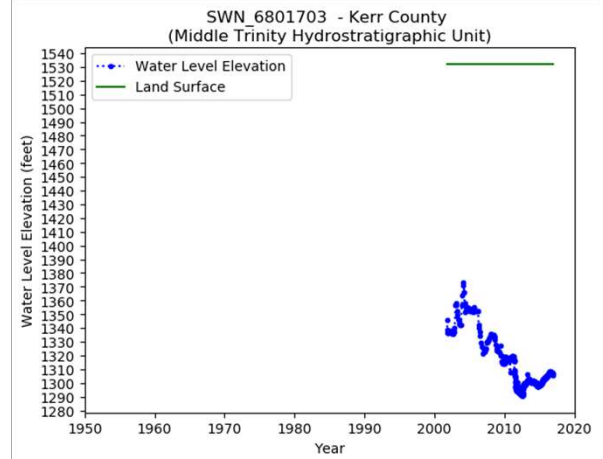
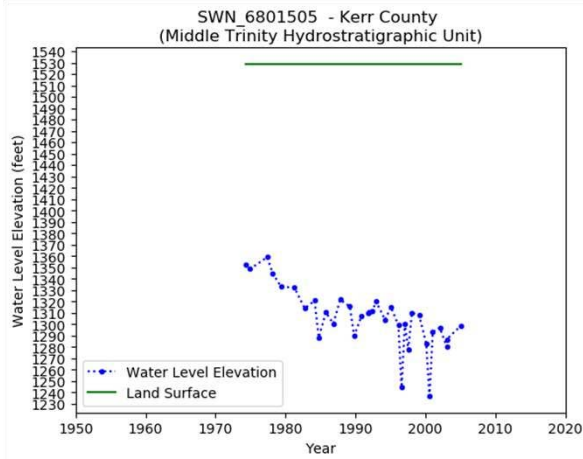
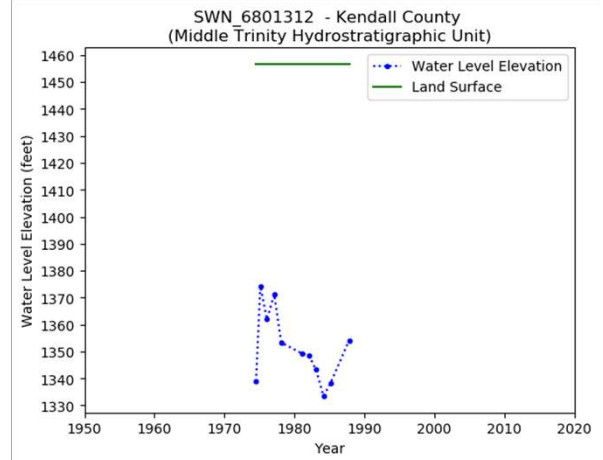
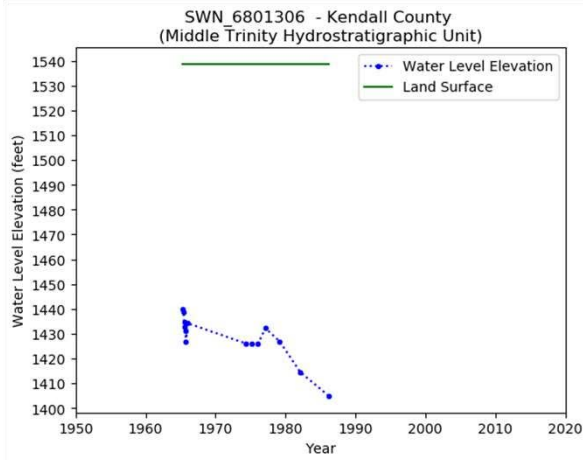

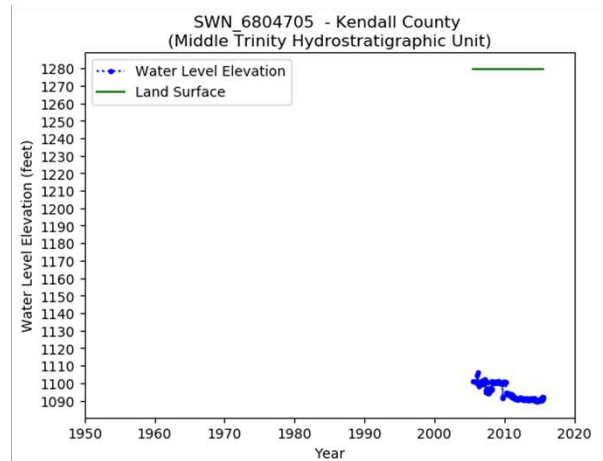
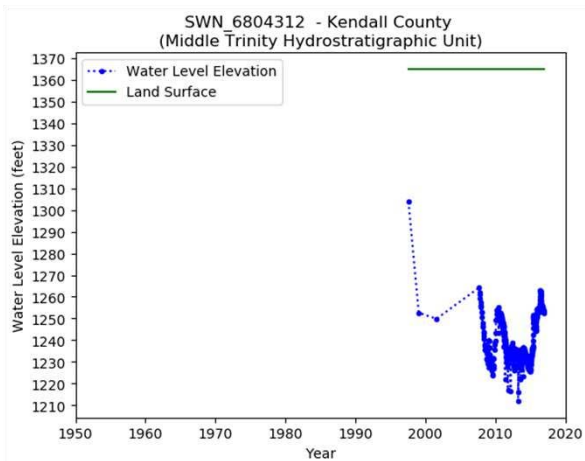
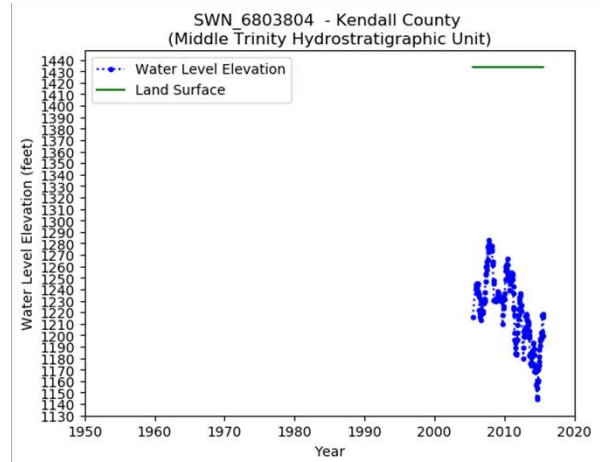
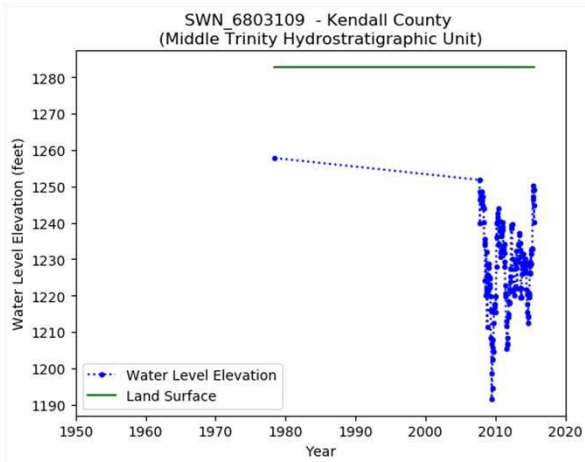
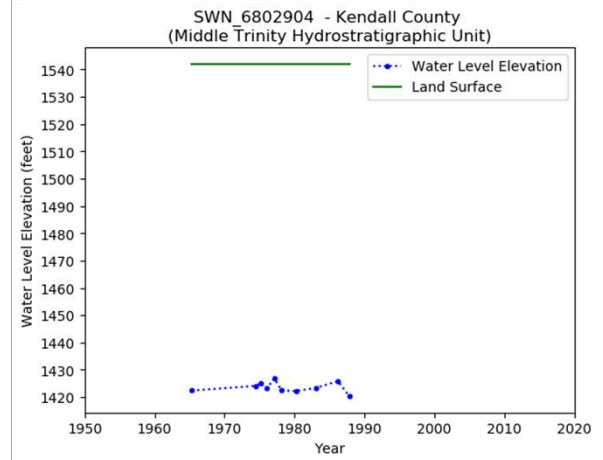
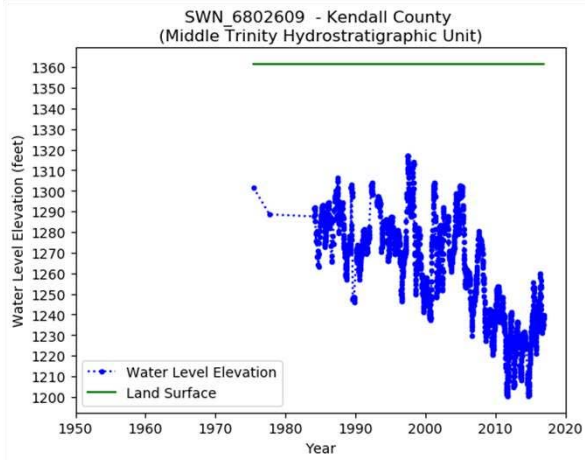

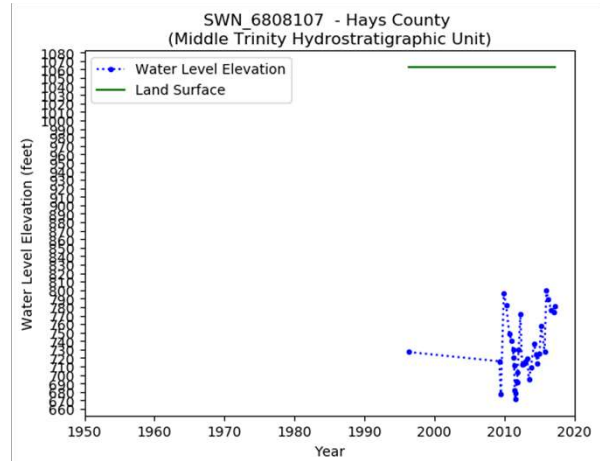
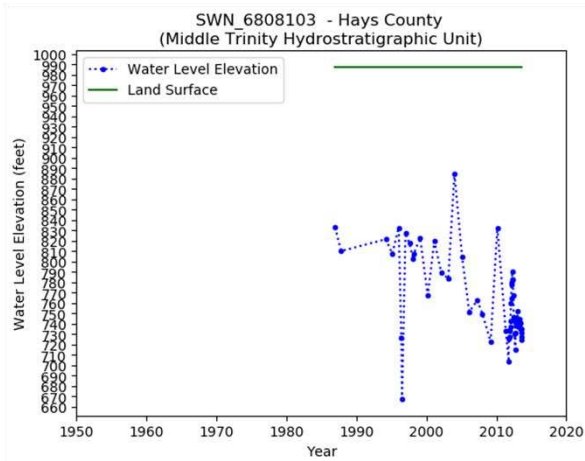
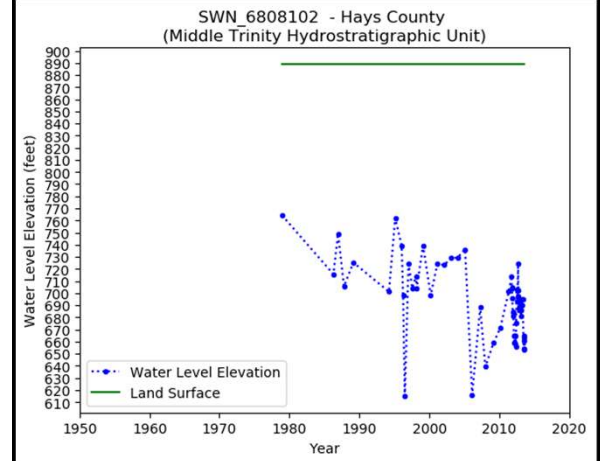
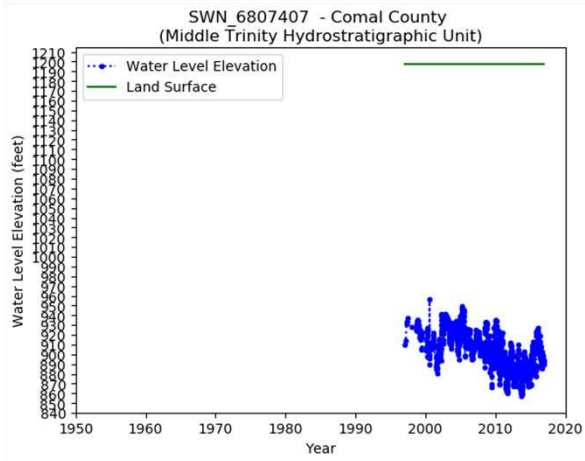
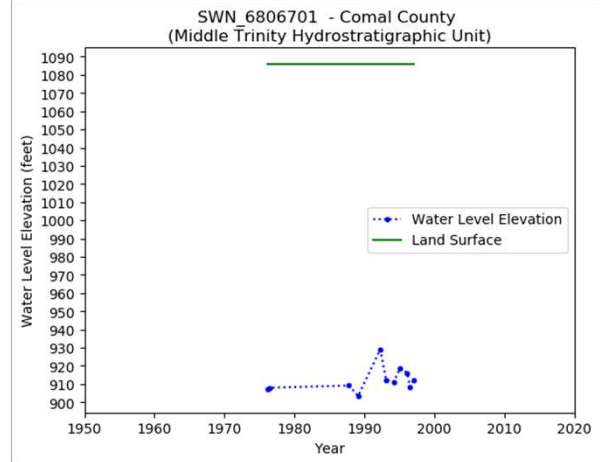
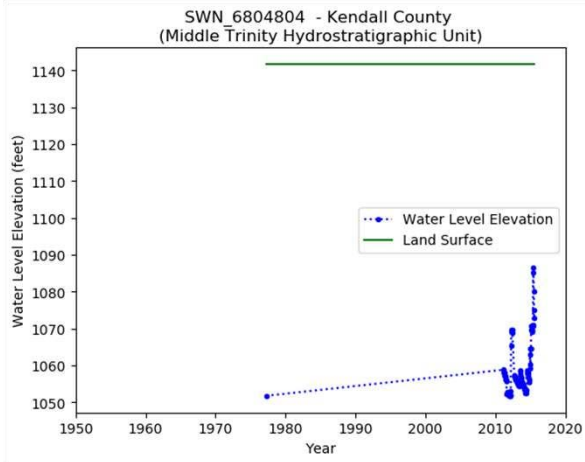

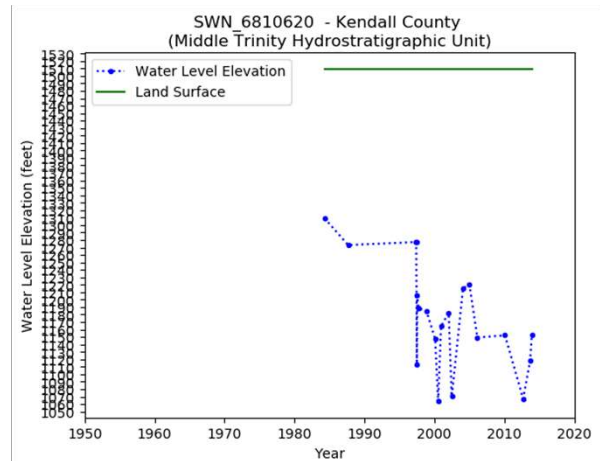
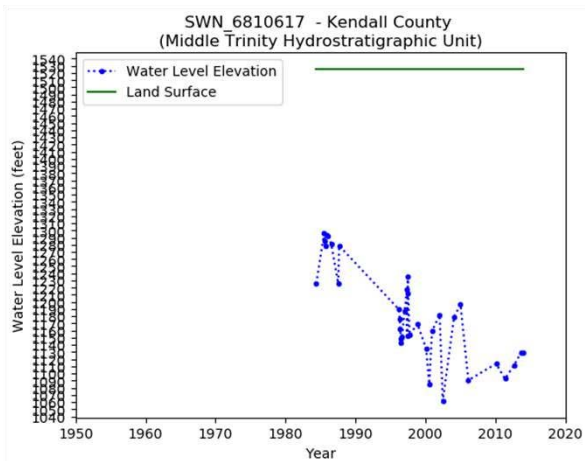
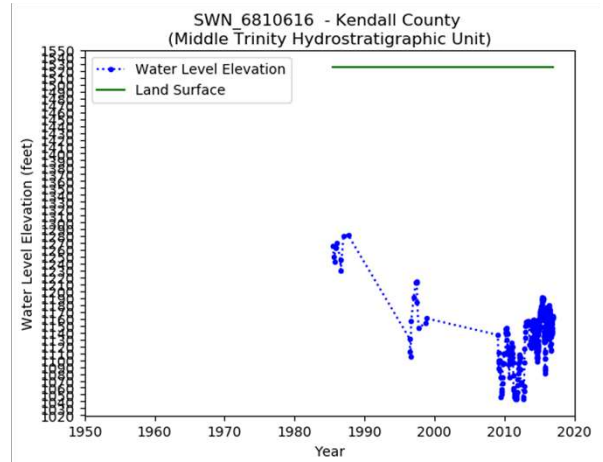
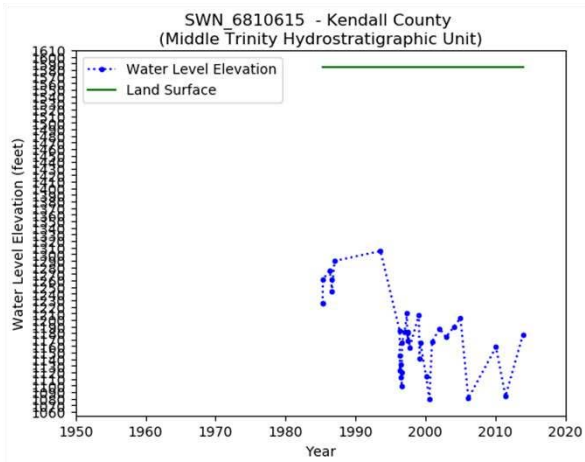
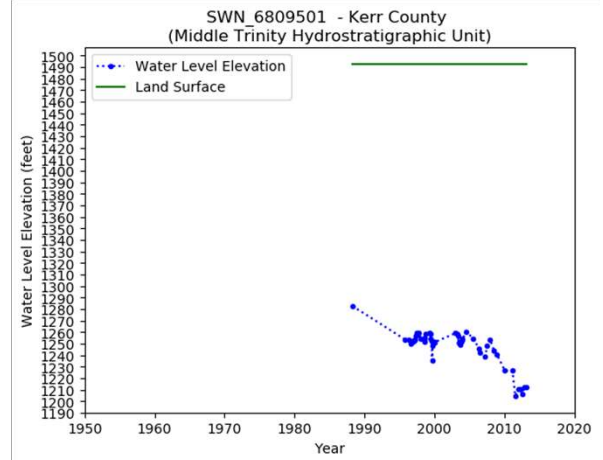
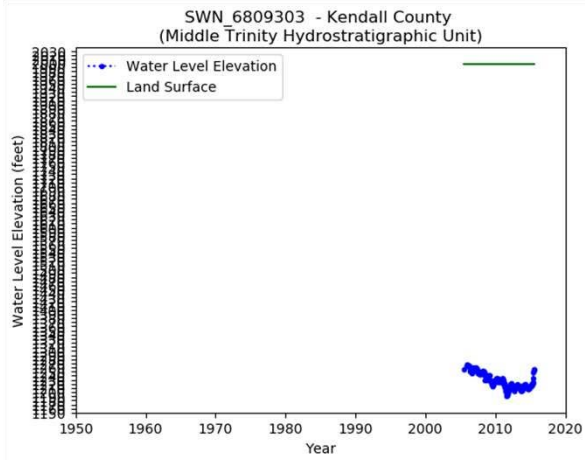

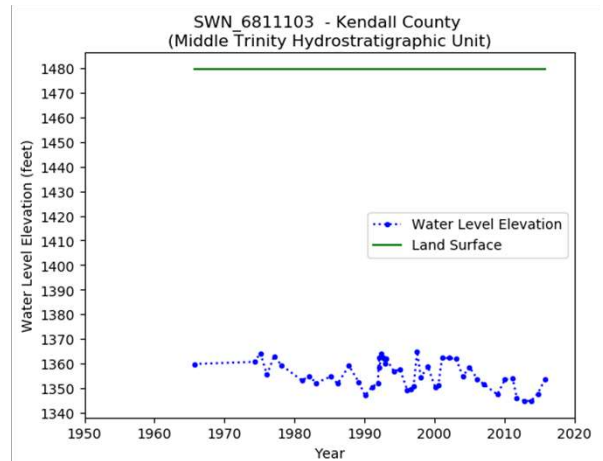
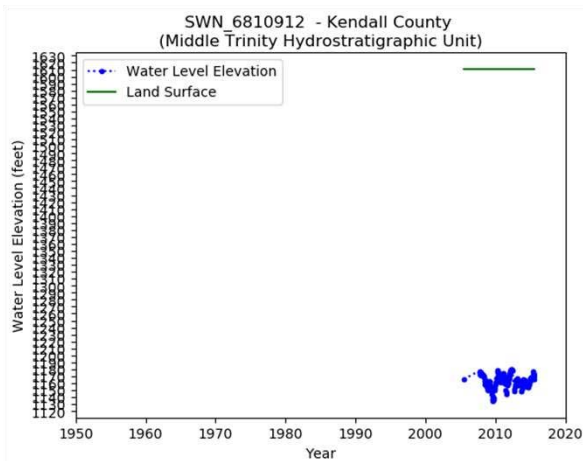
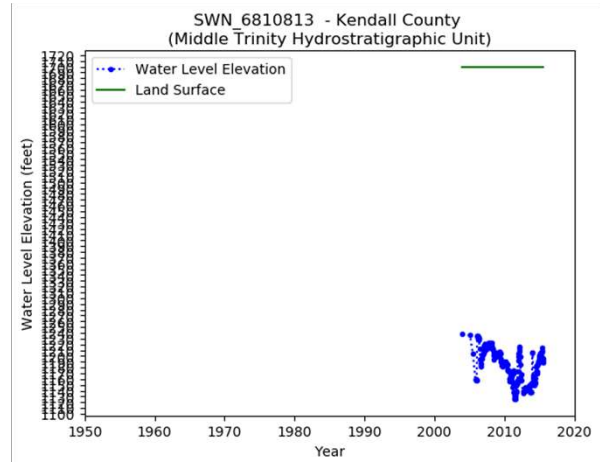
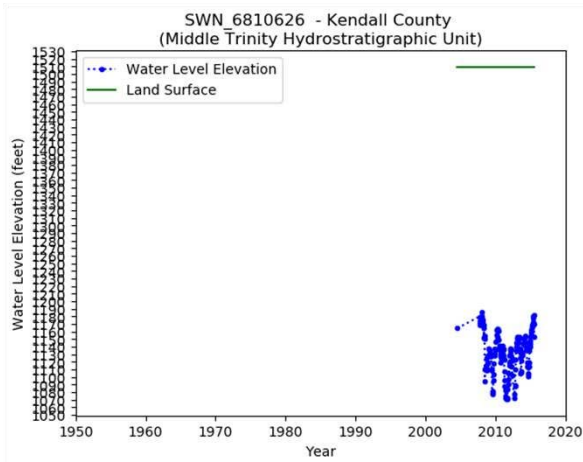
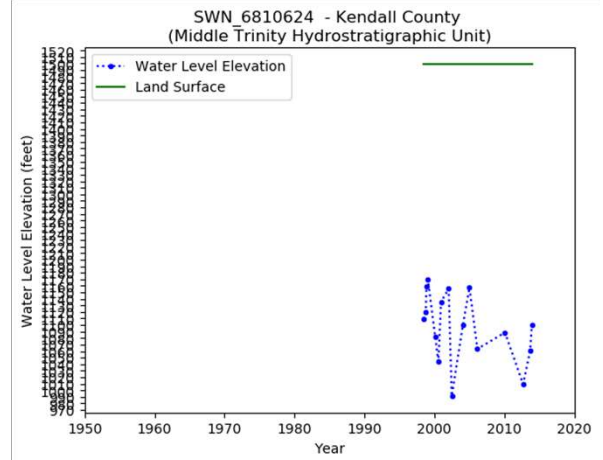
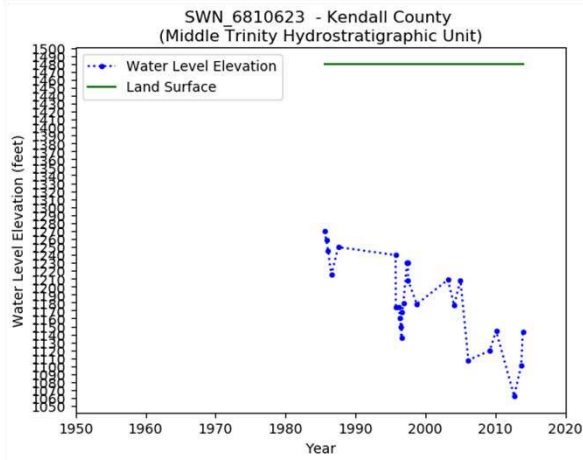

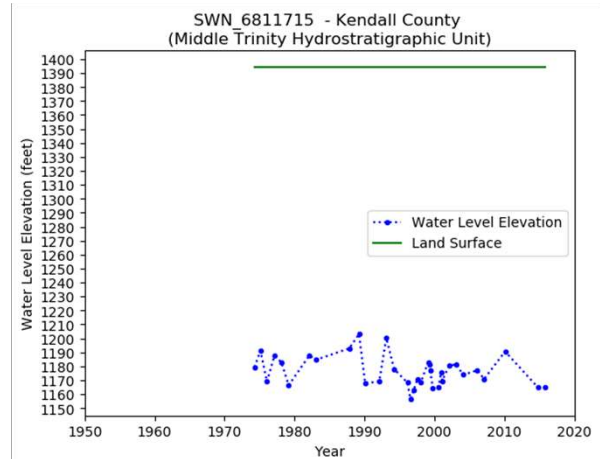
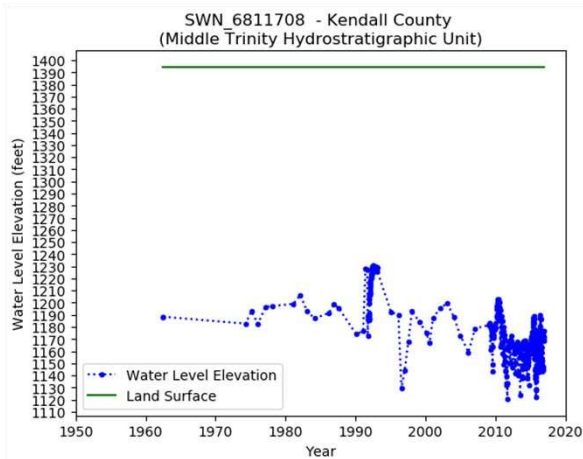
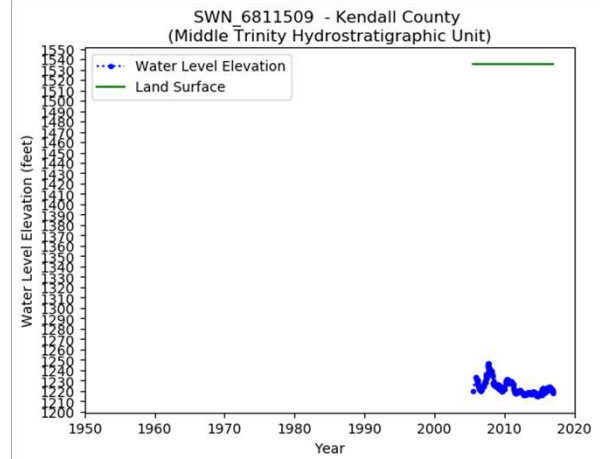
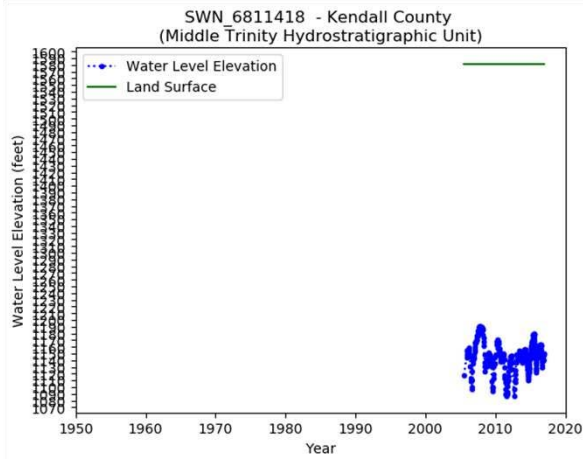
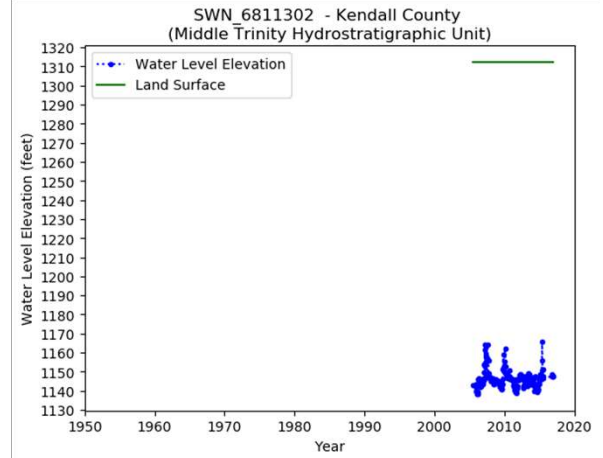
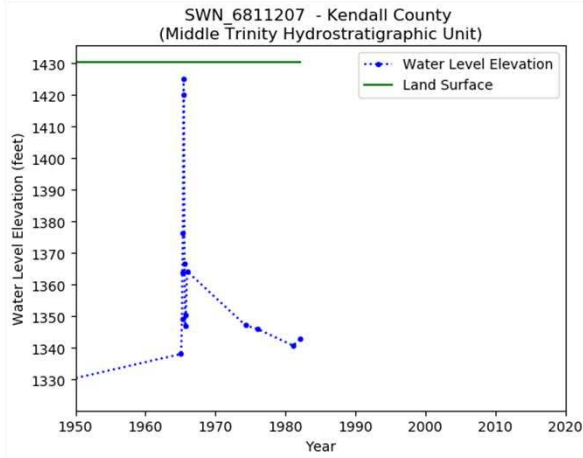

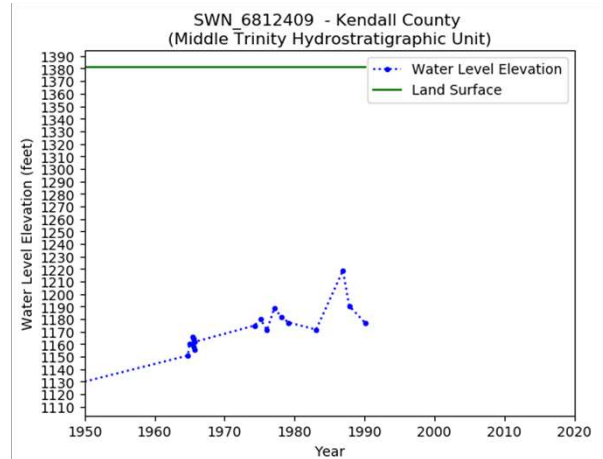
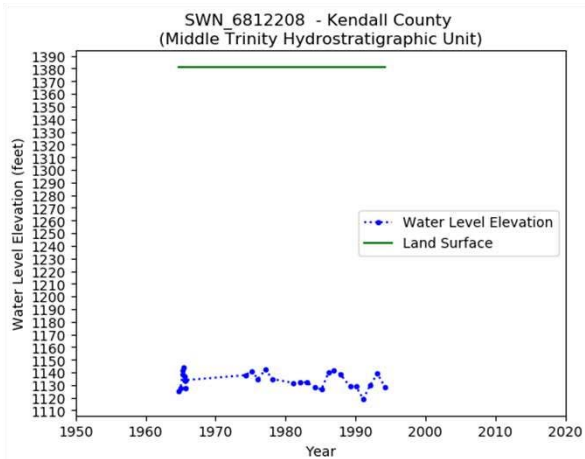
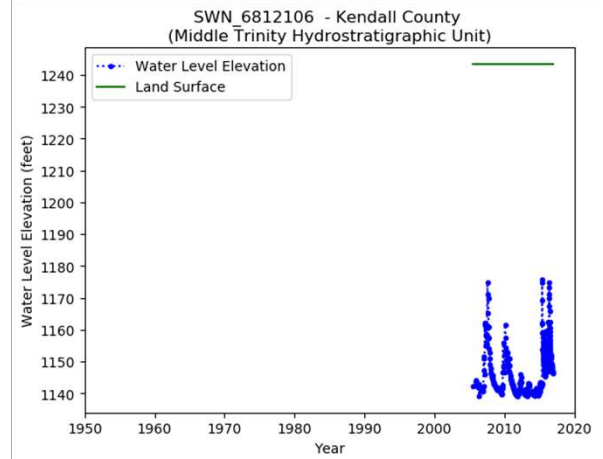
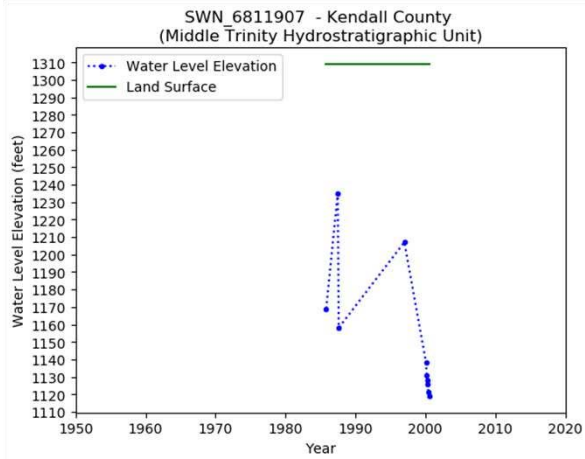
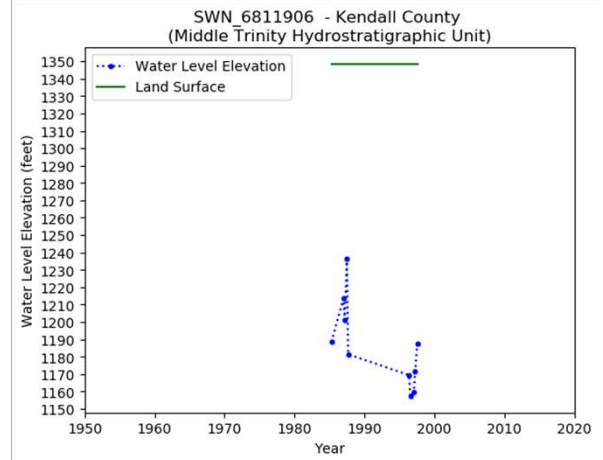
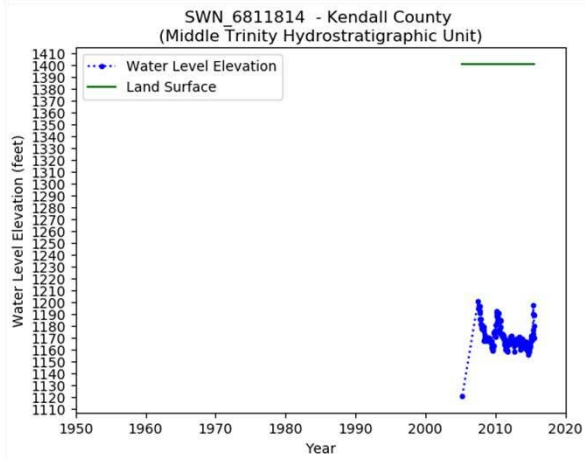

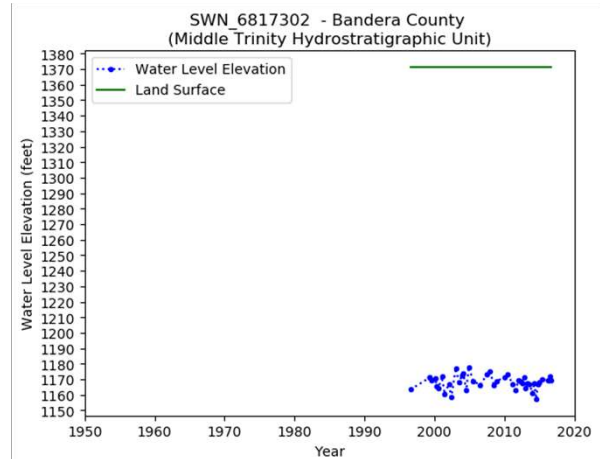
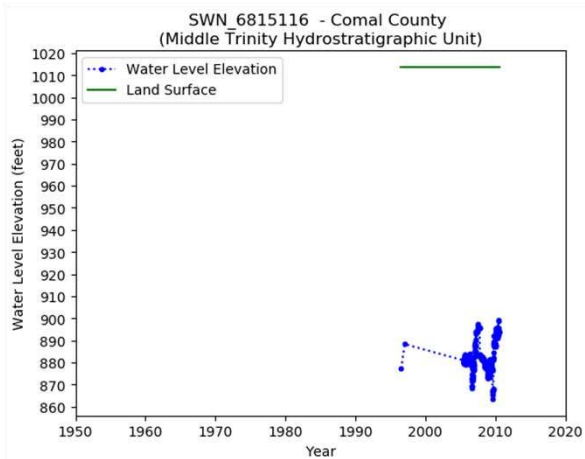
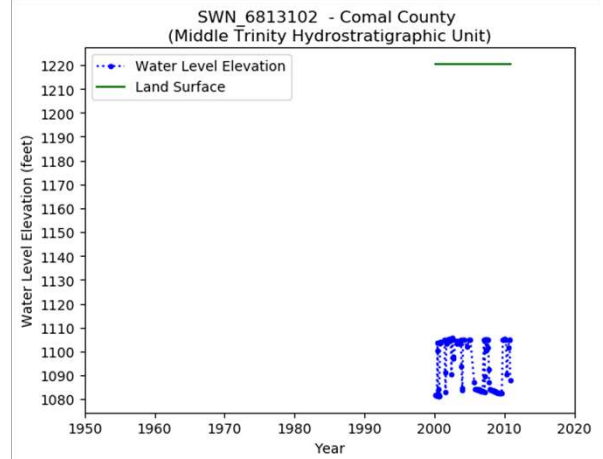
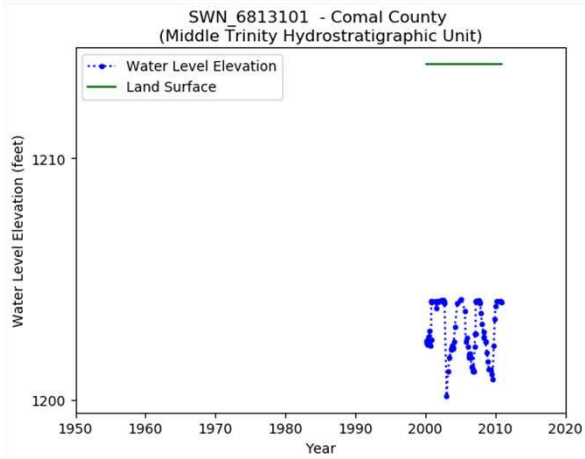
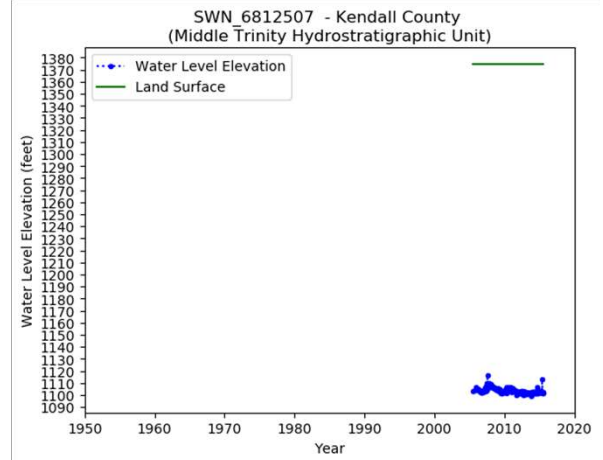
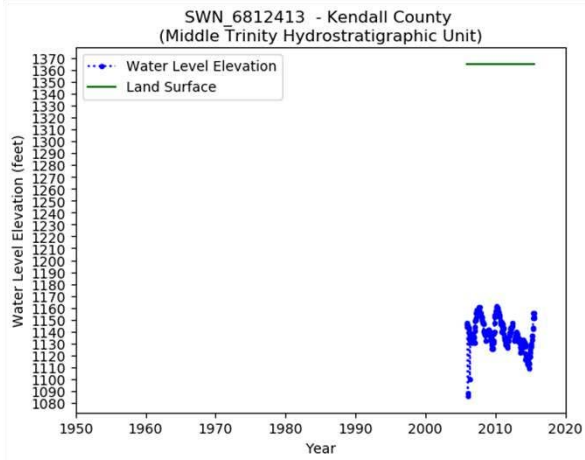

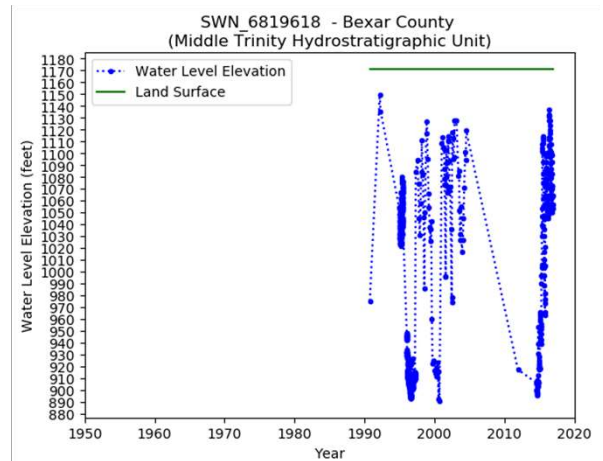
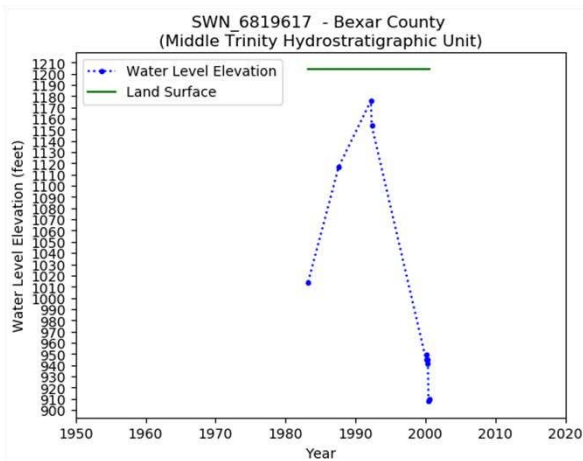
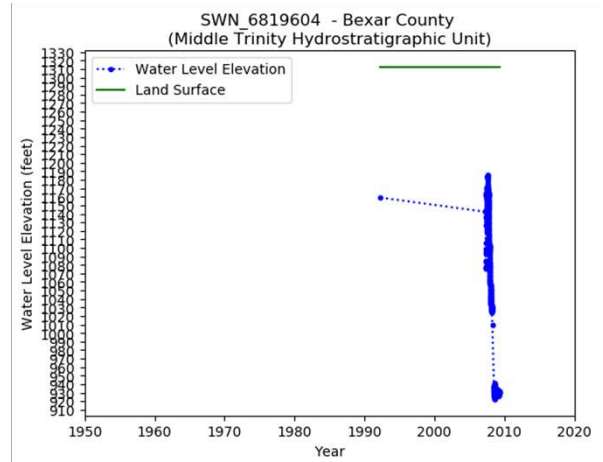
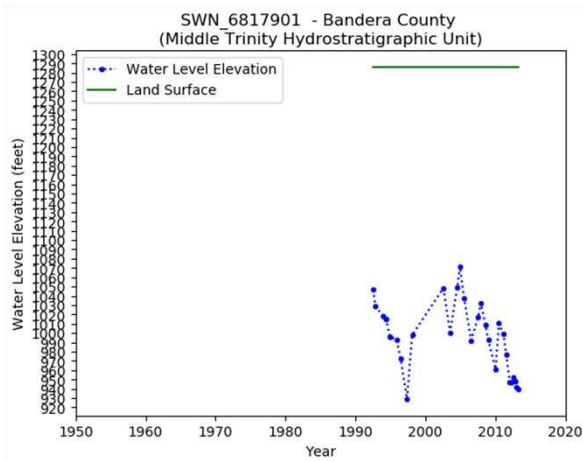
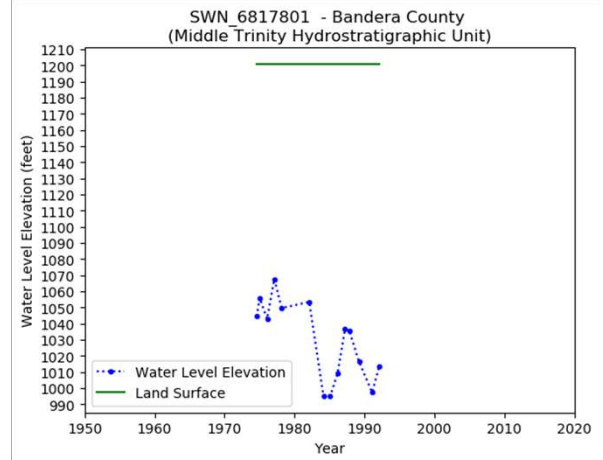
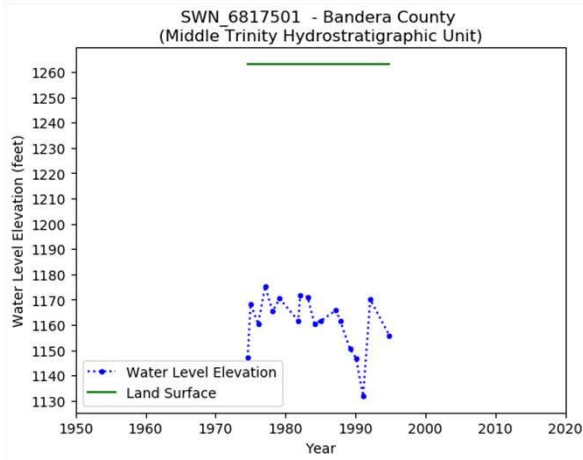

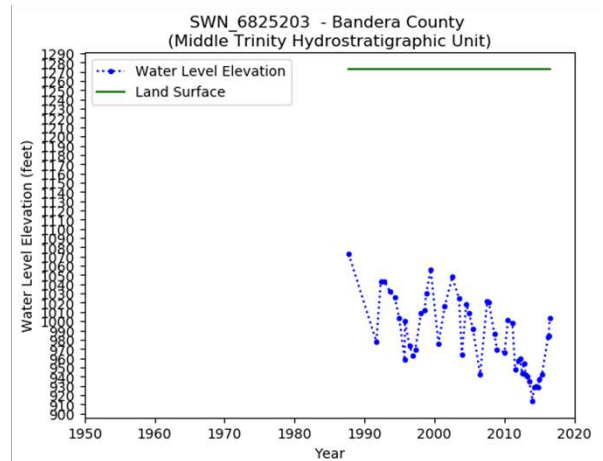
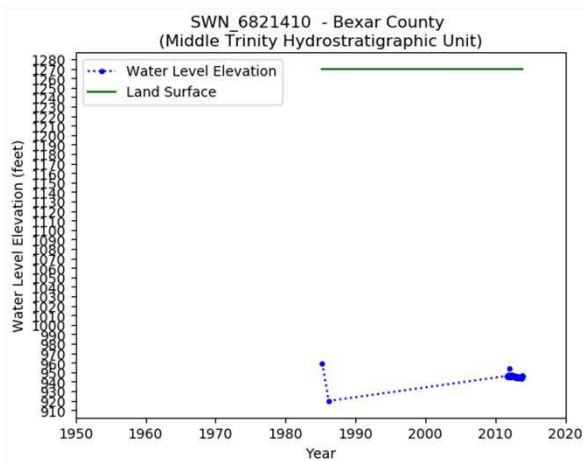
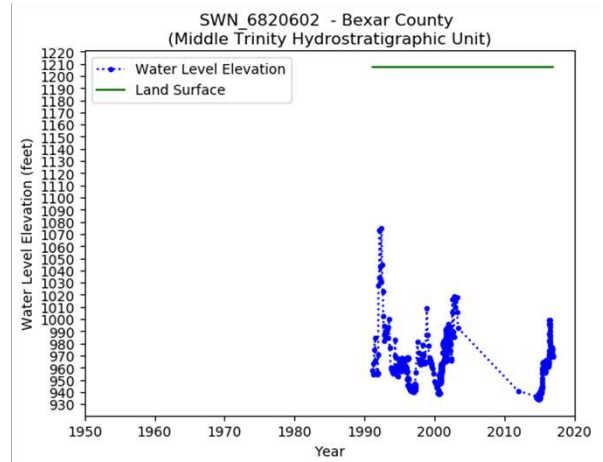
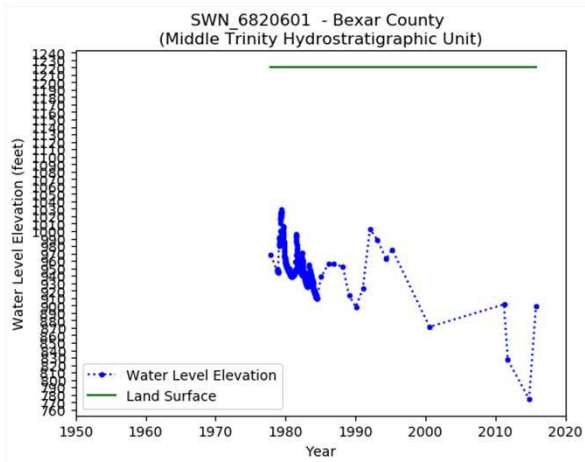
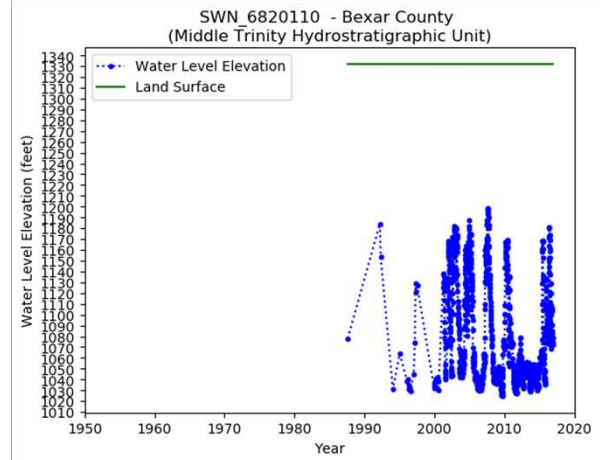
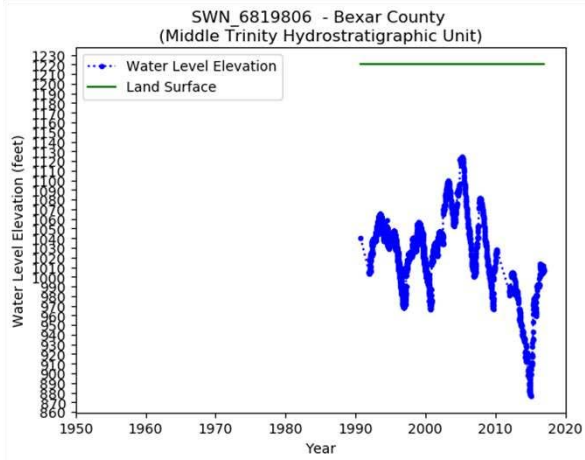

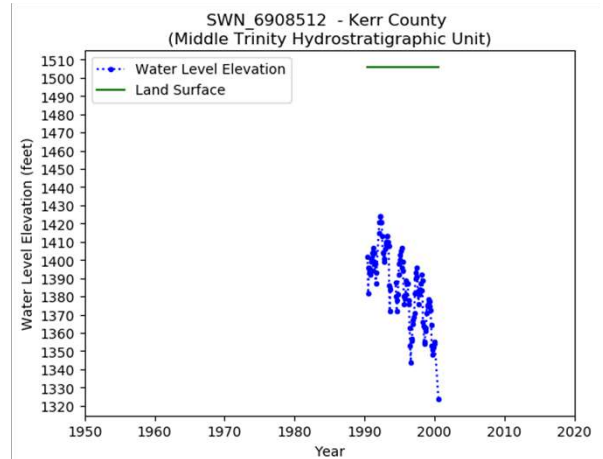
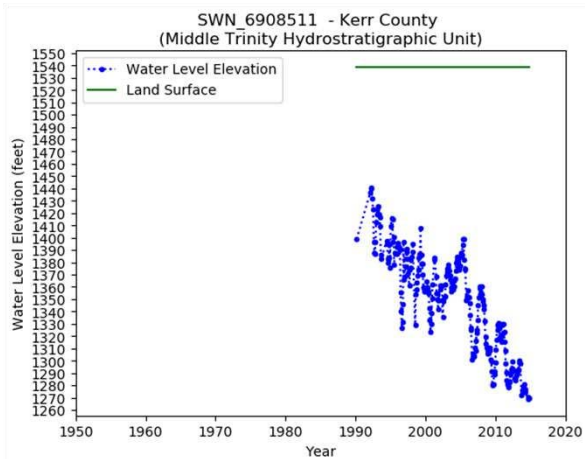
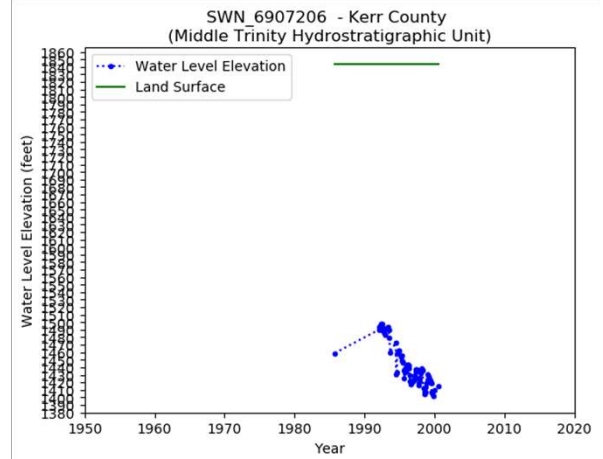
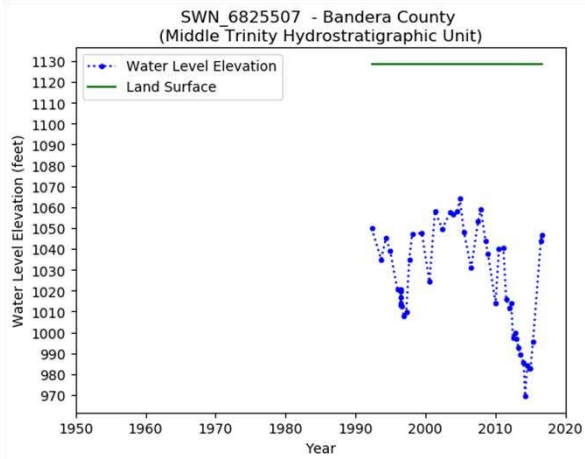
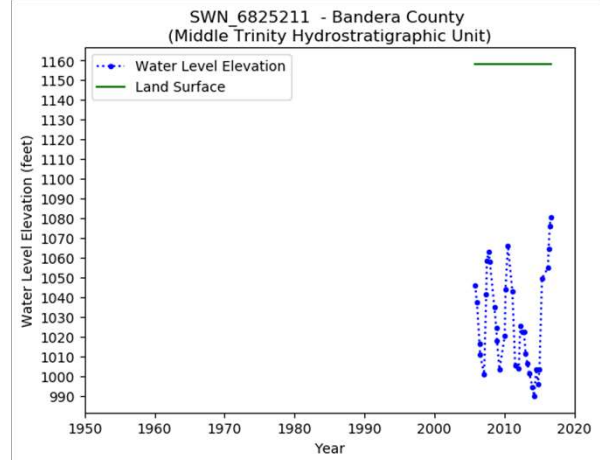
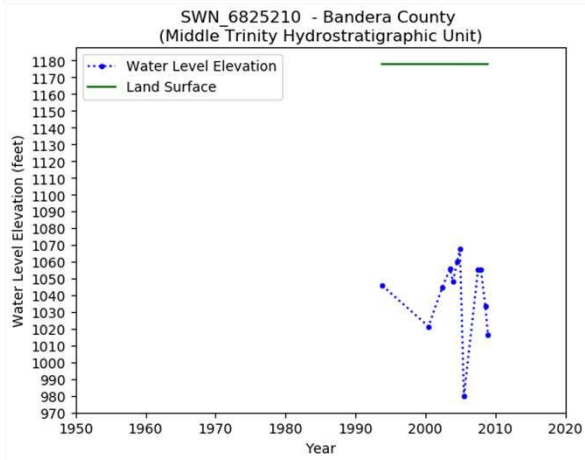

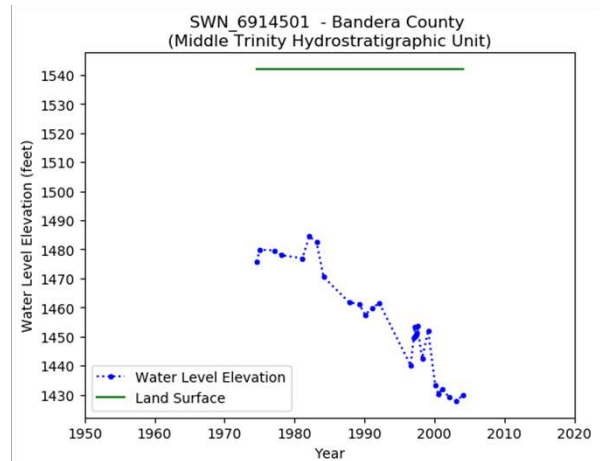
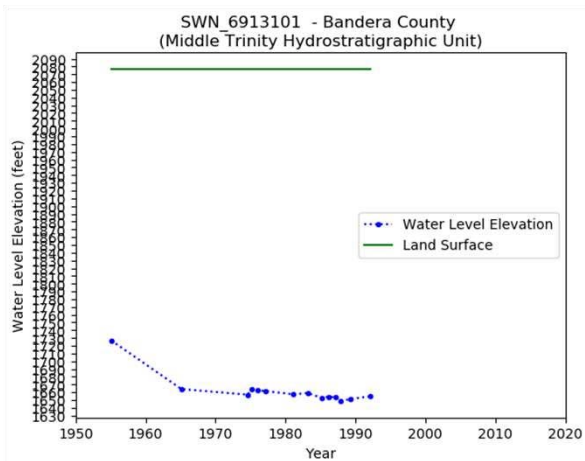
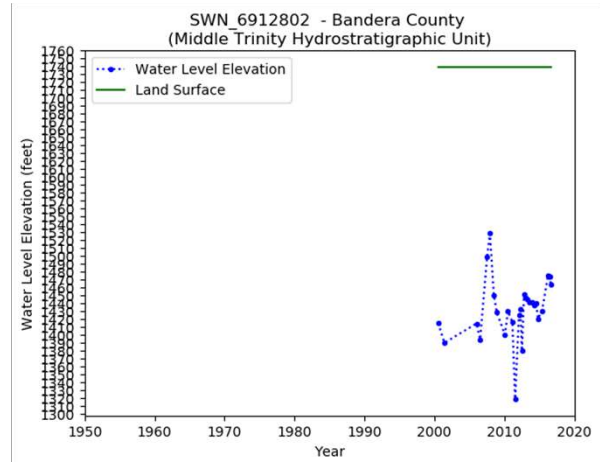
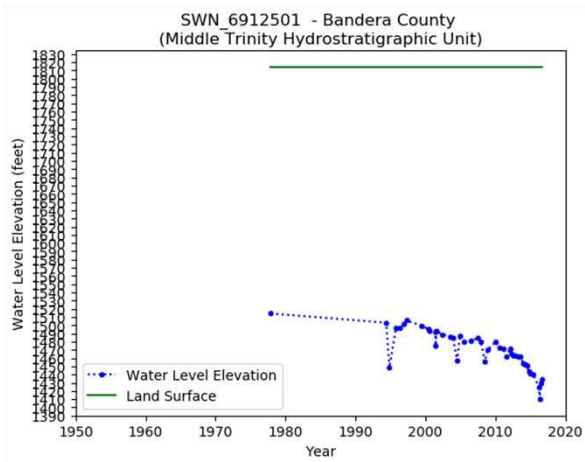
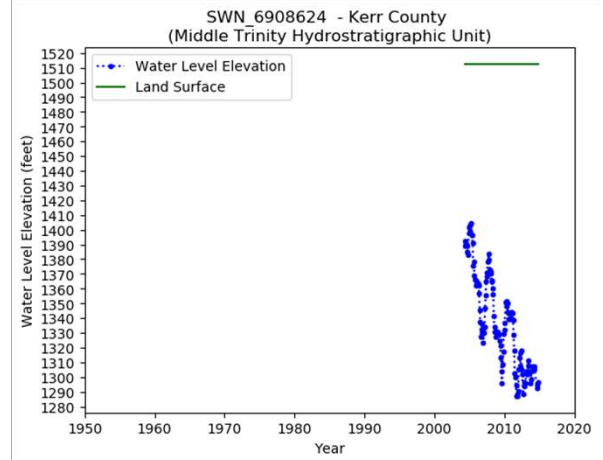
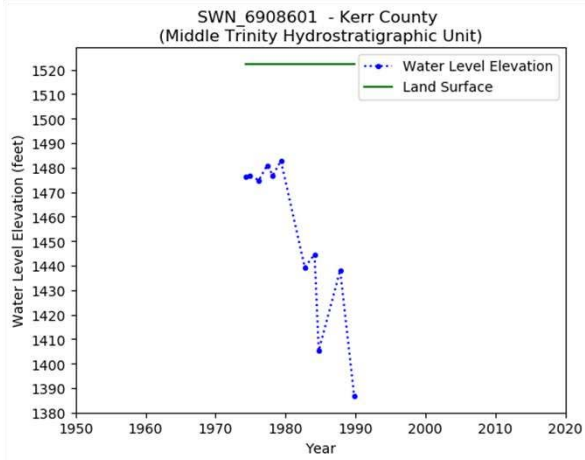

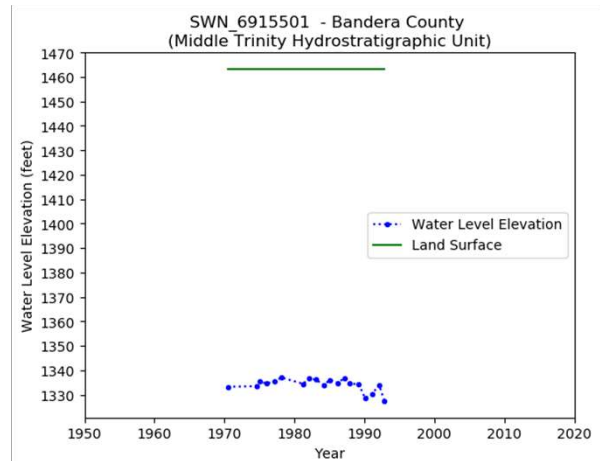
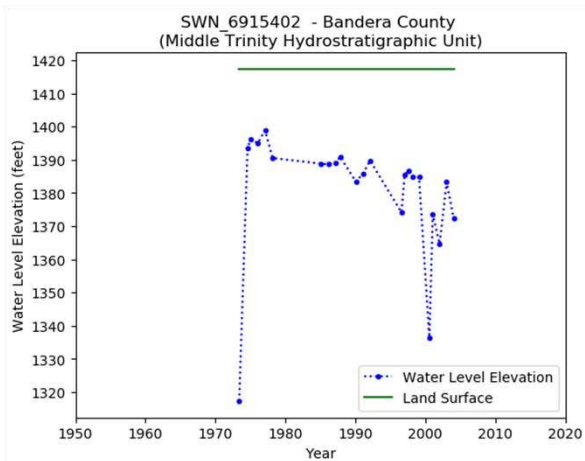
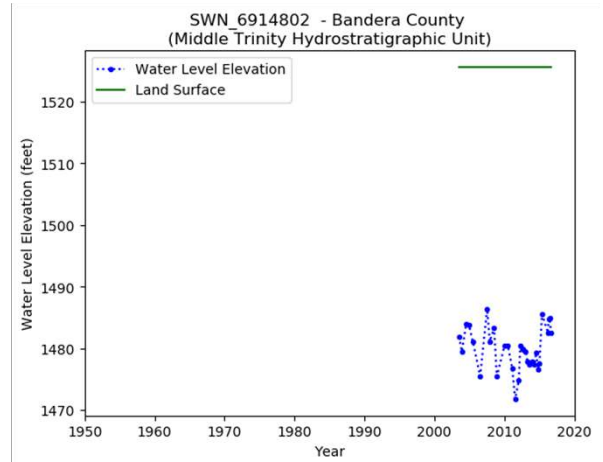
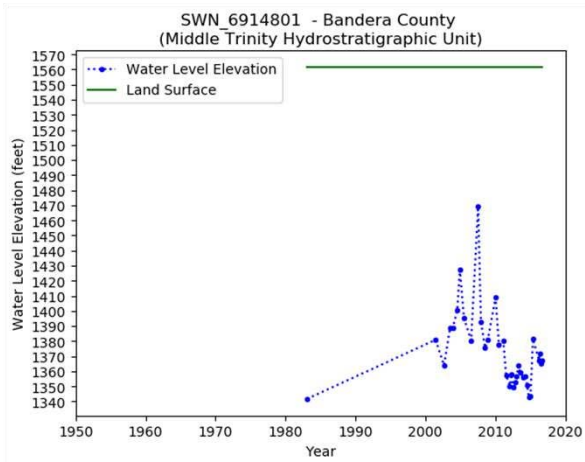
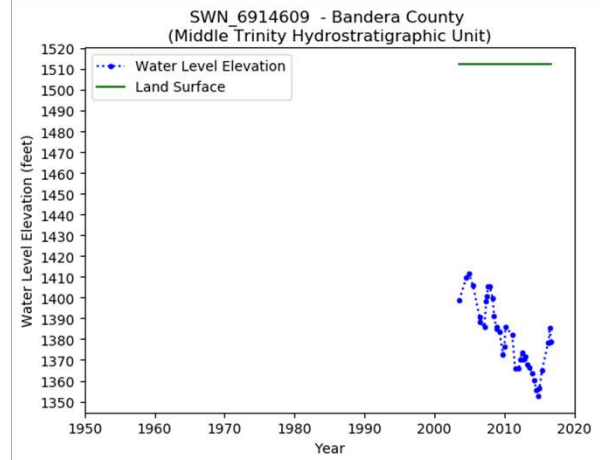
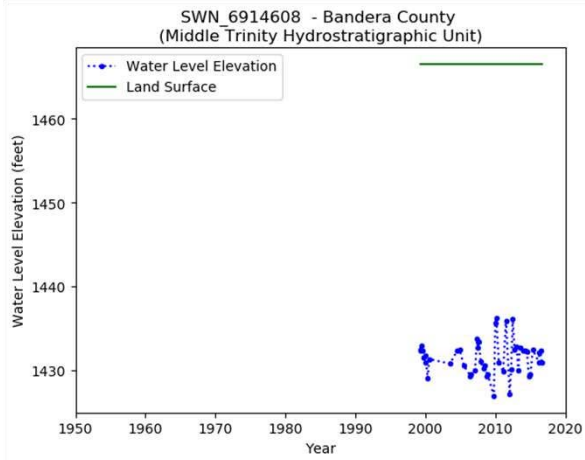

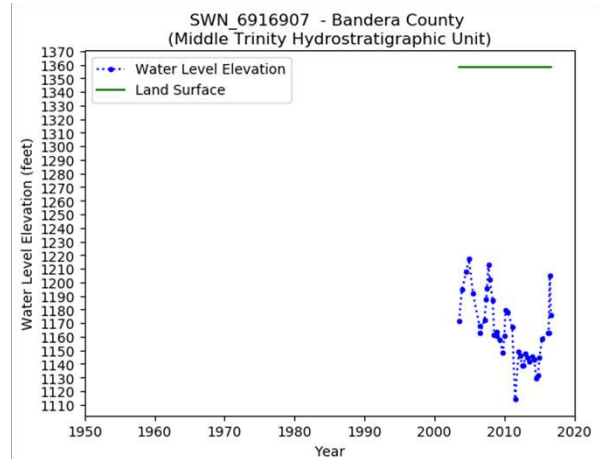
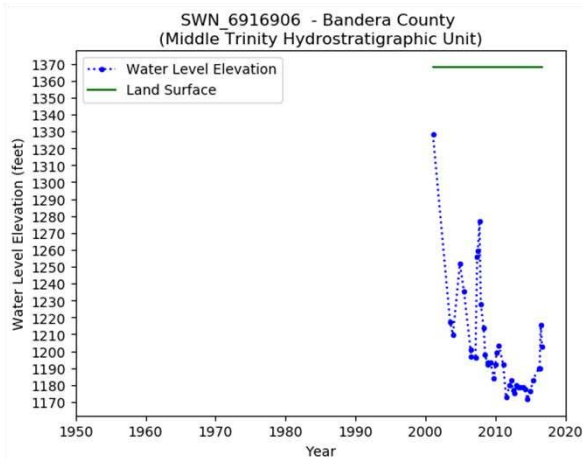
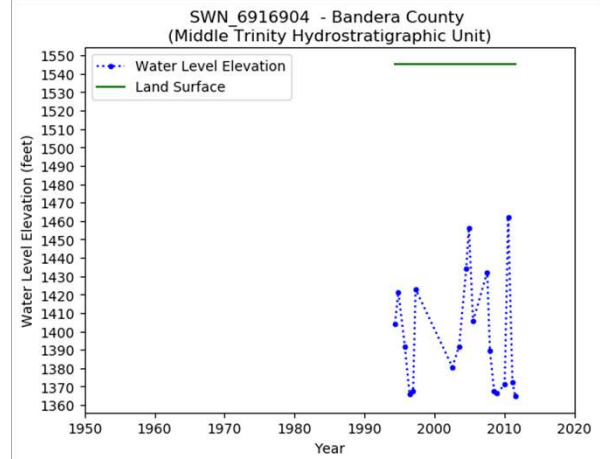
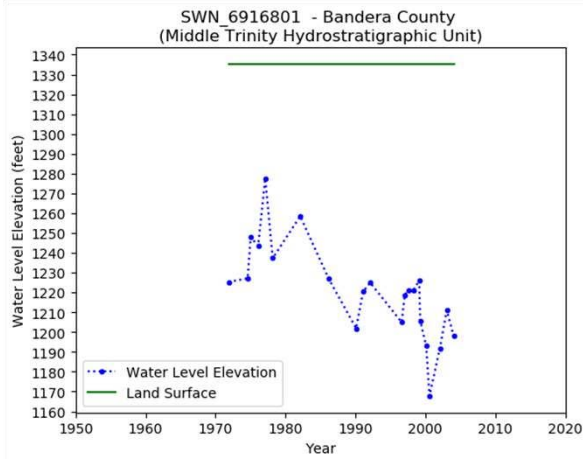
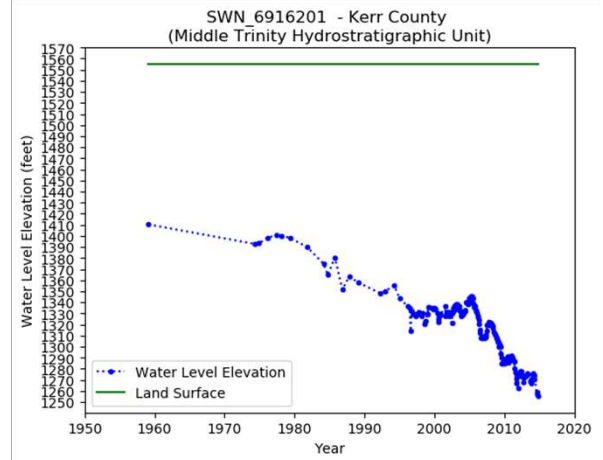
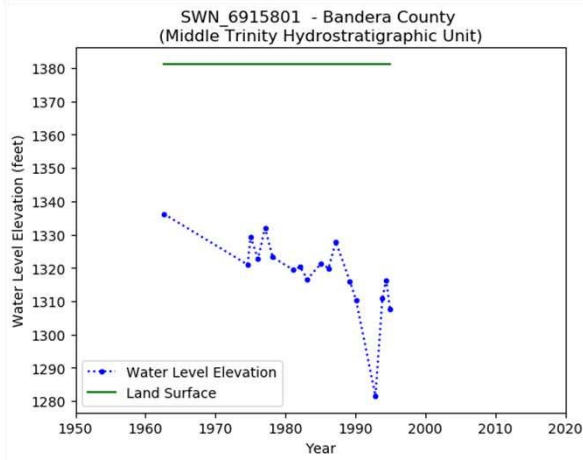

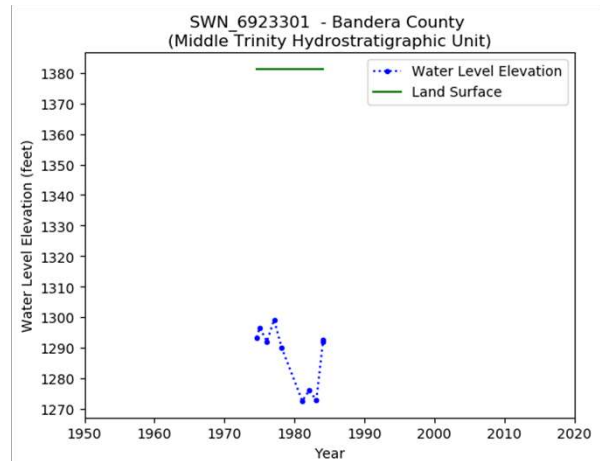
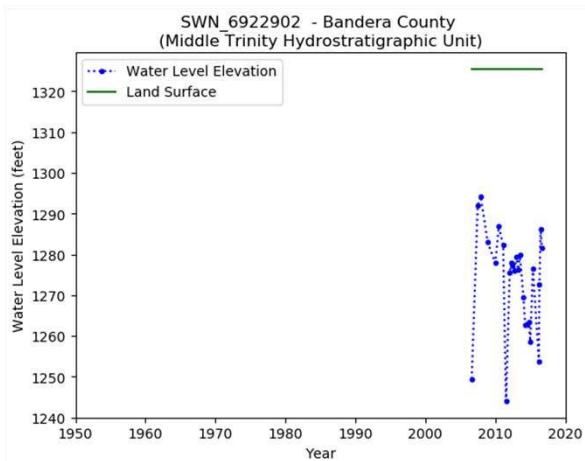
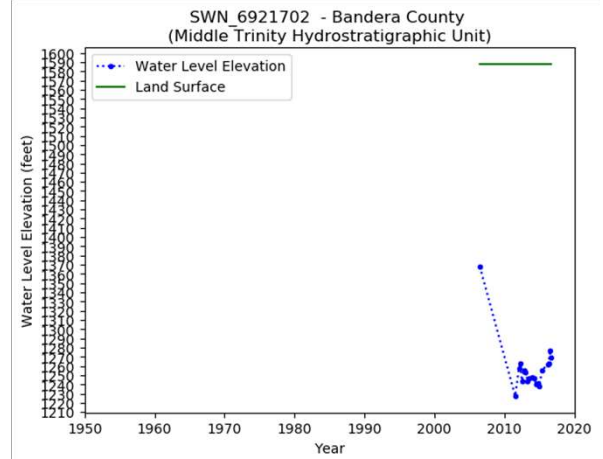
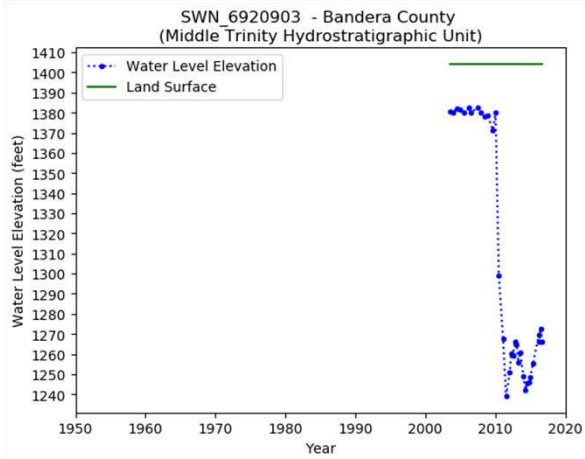
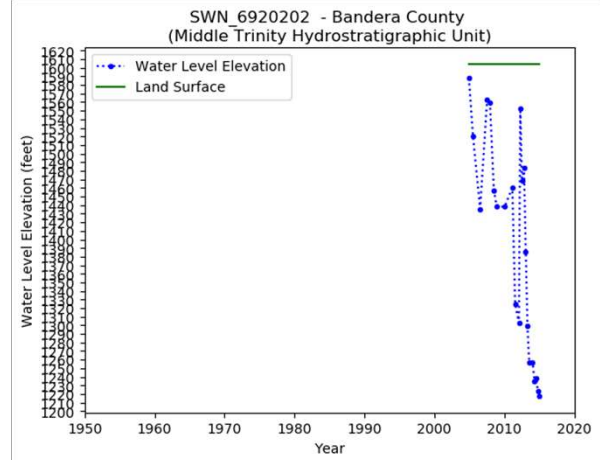
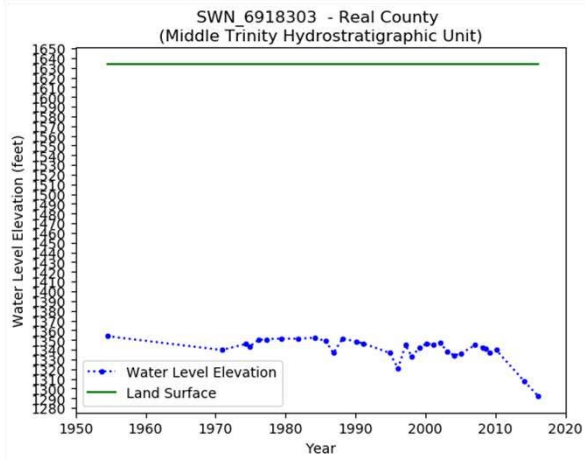

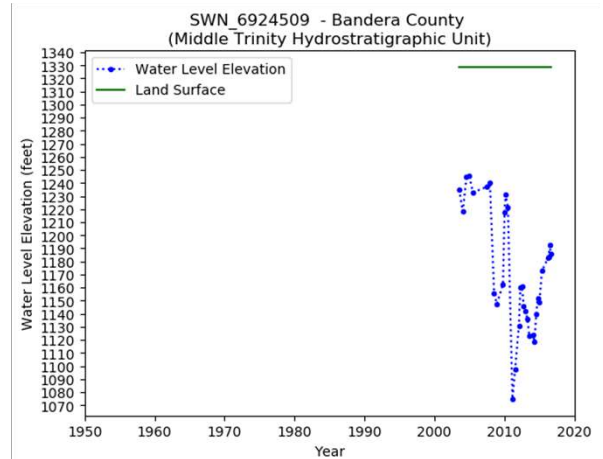
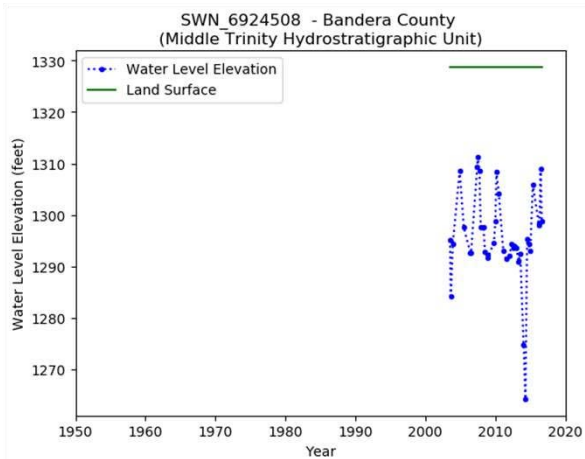
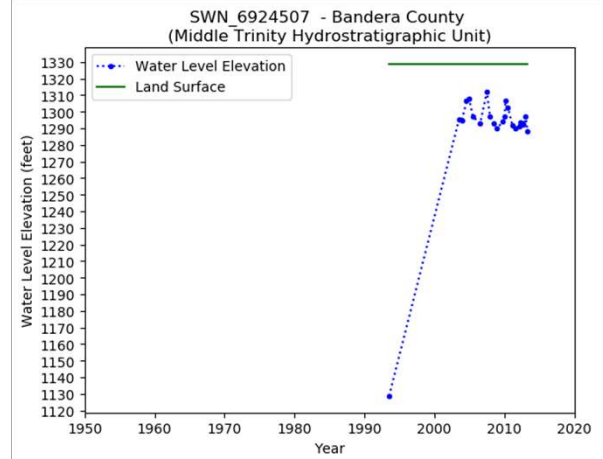
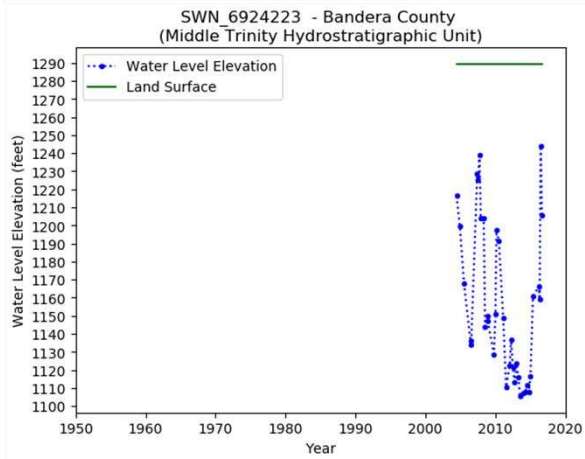
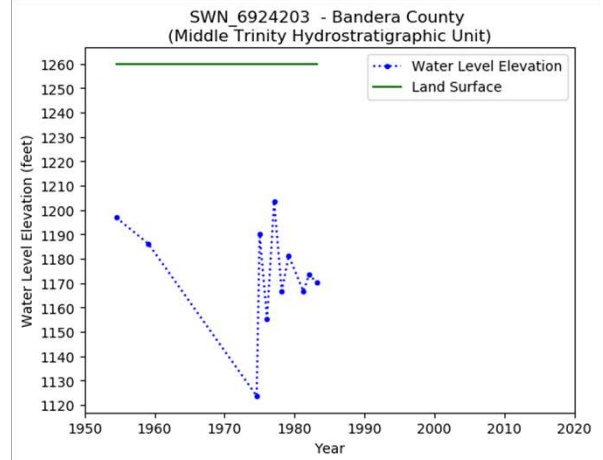
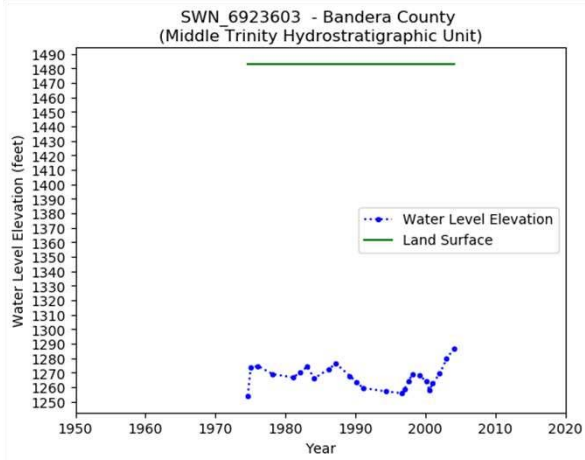

Lower Trinity Hydrographs

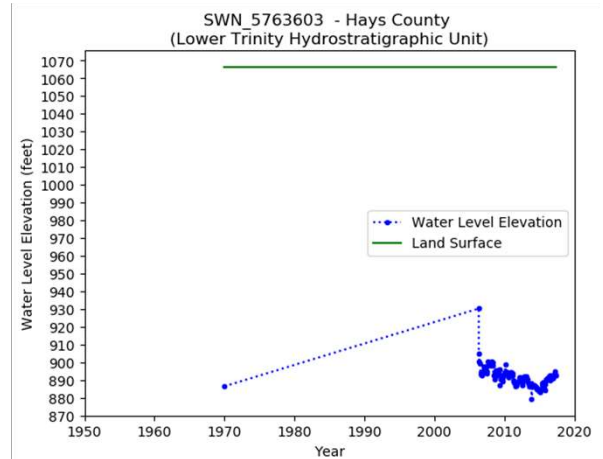
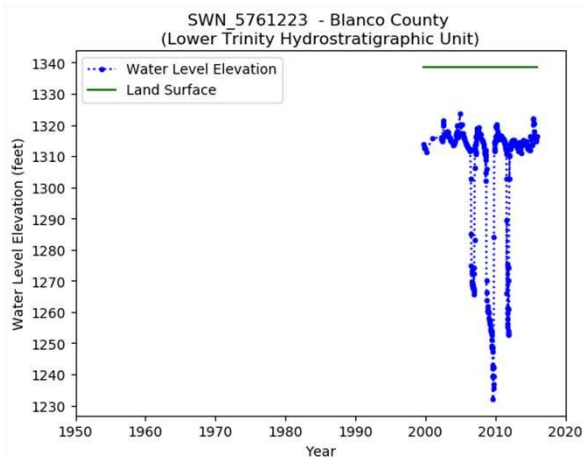
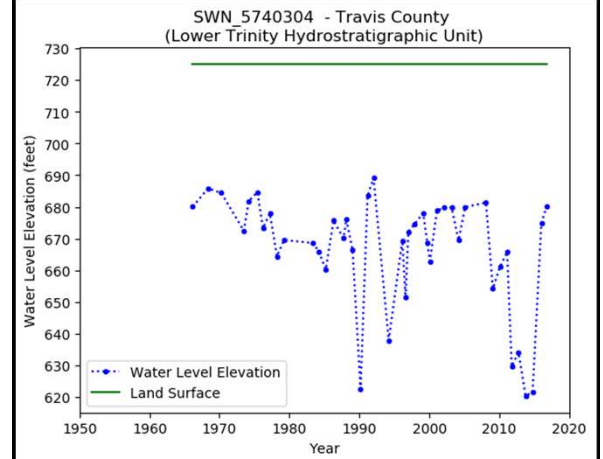
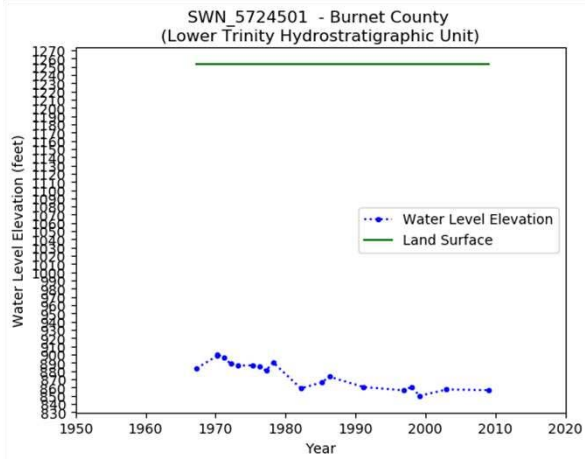
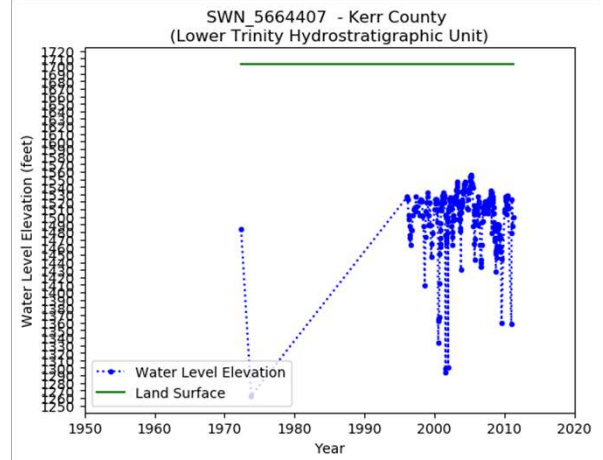
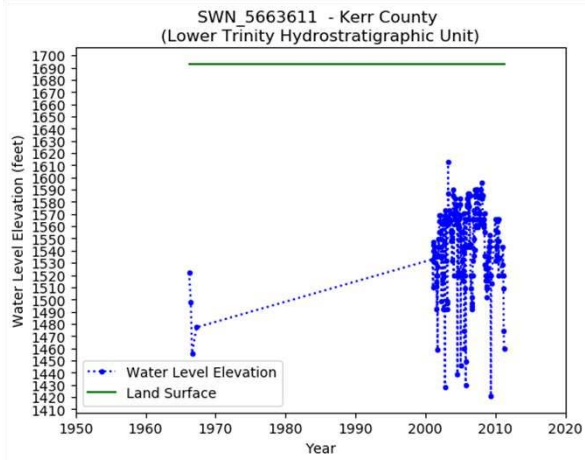

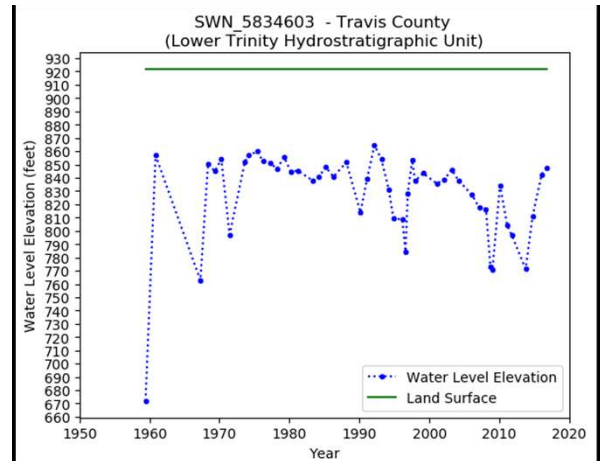
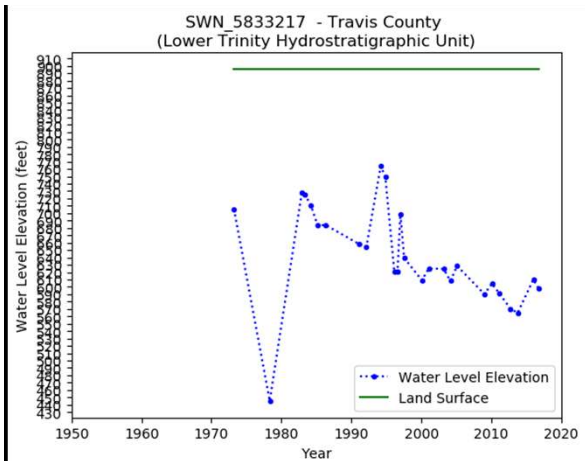
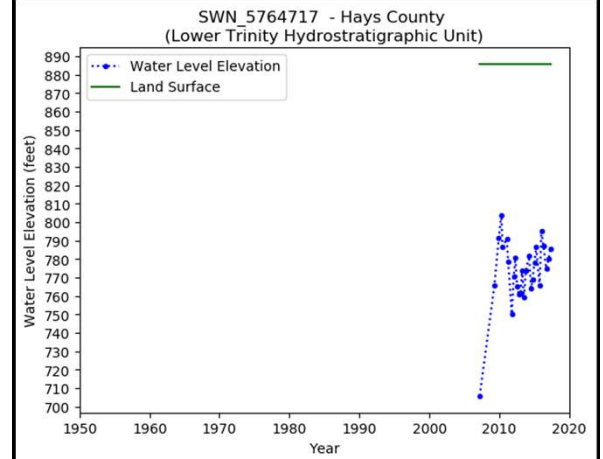
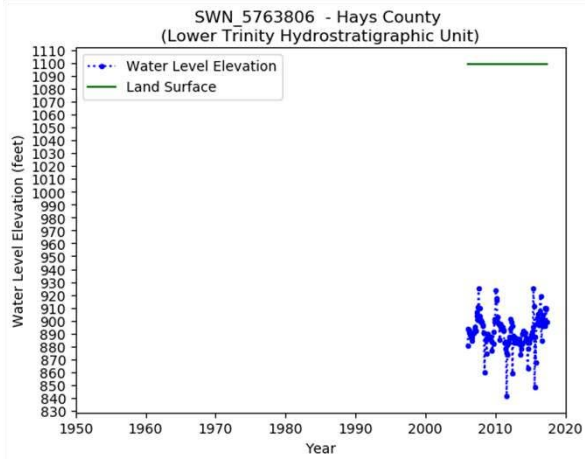
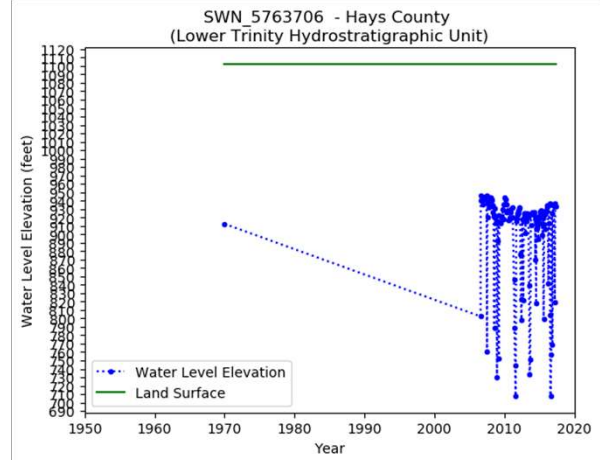
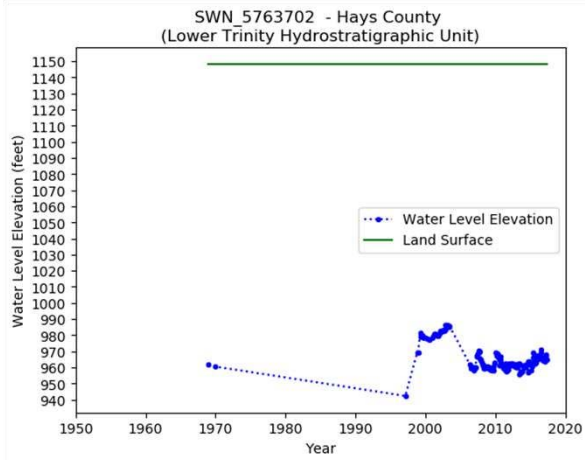

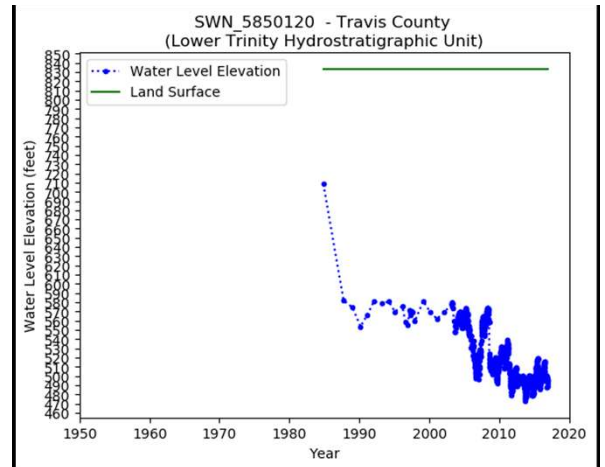
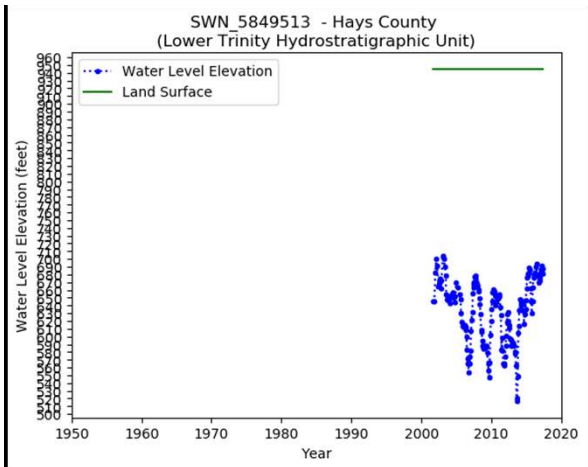
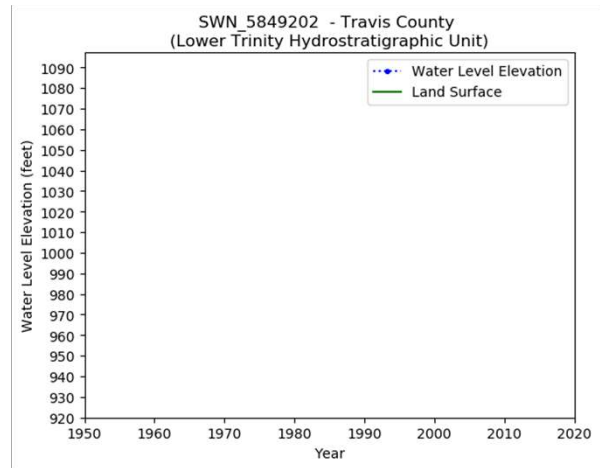
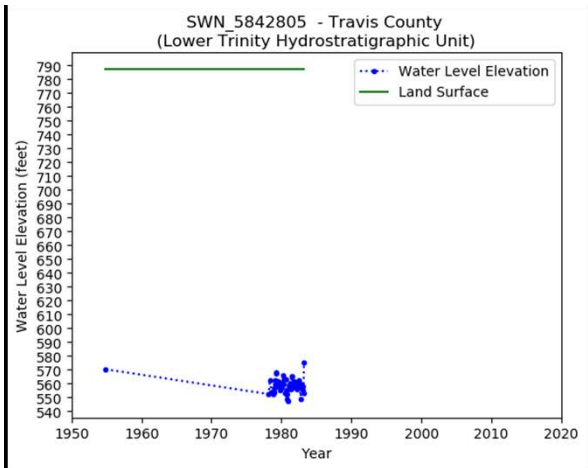
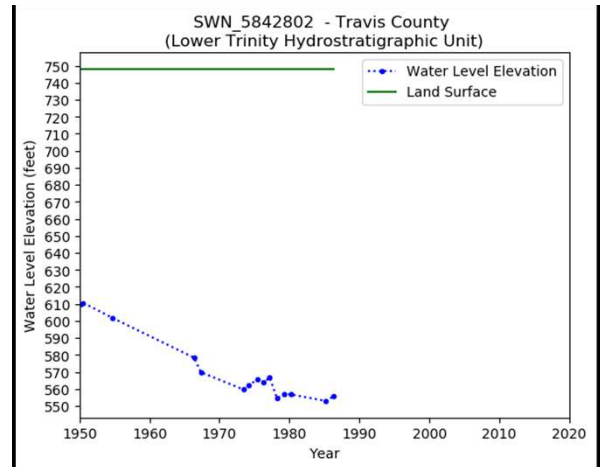
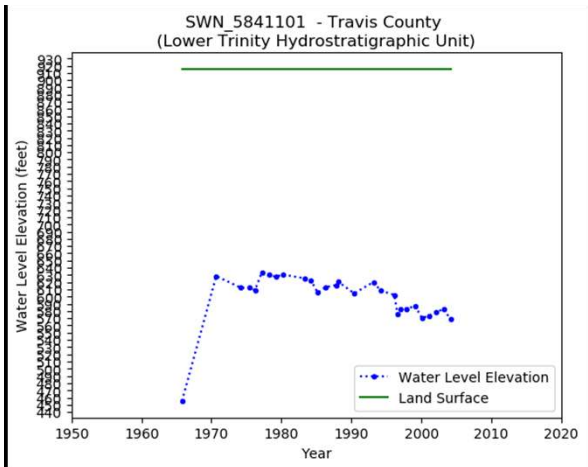

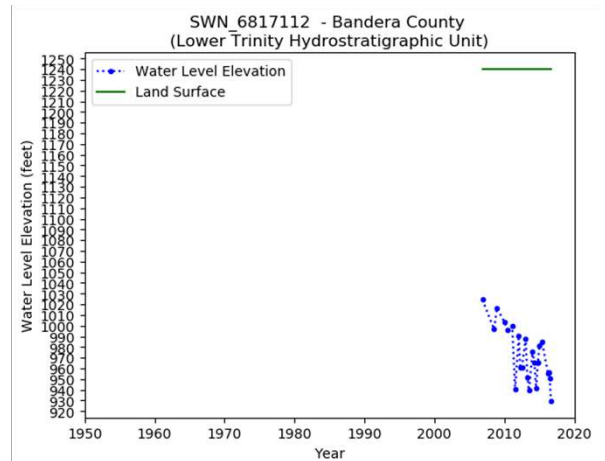
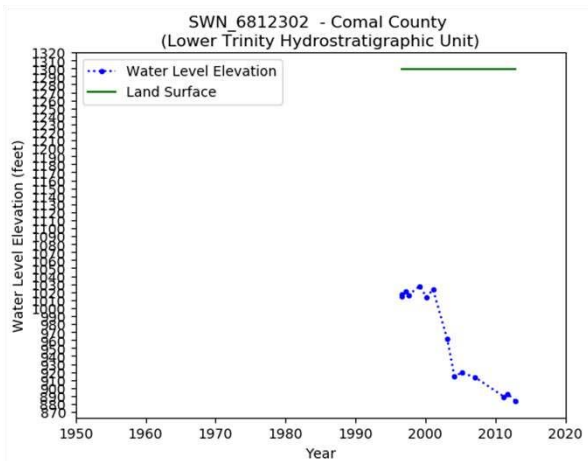
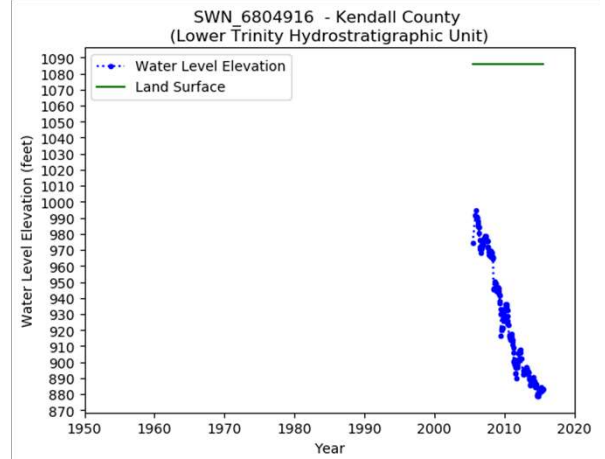
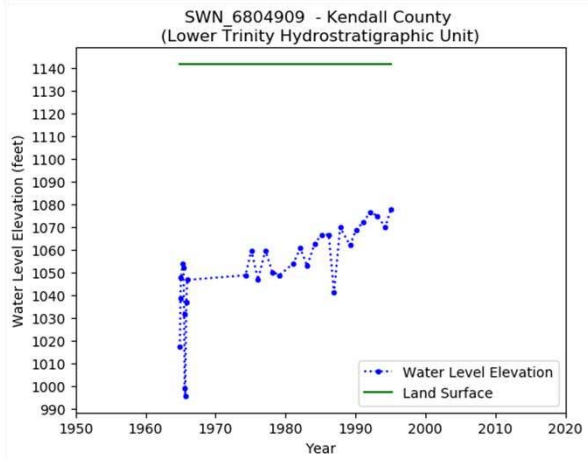
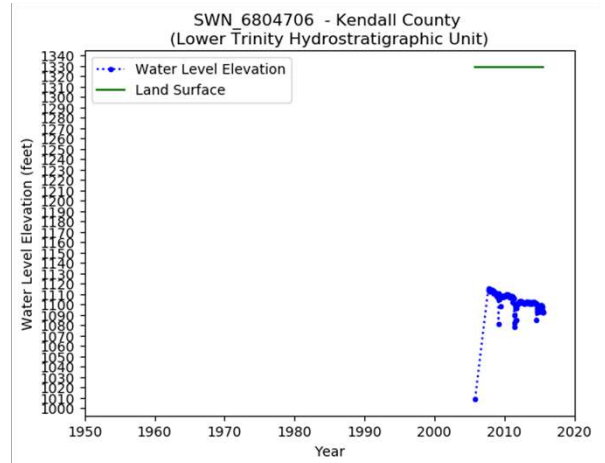
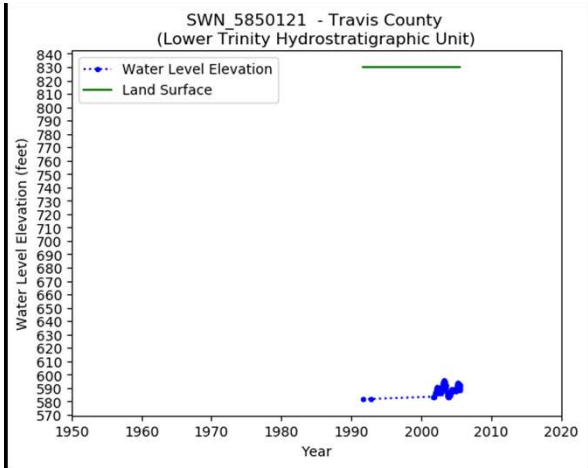

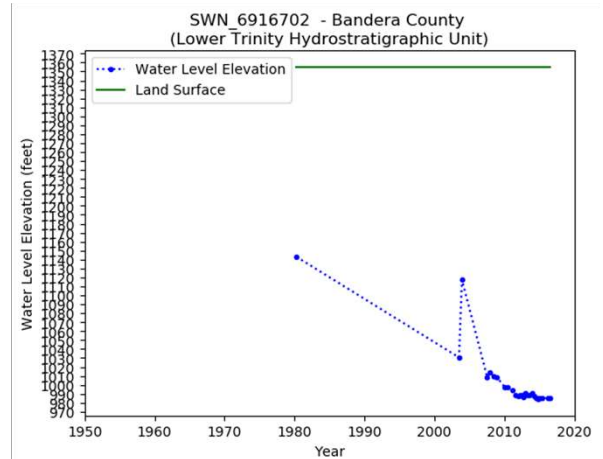
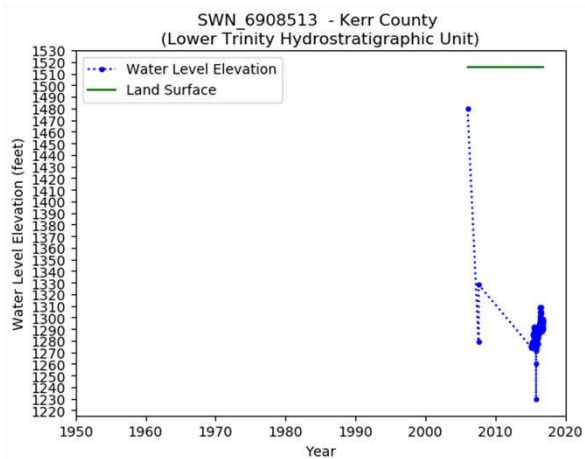
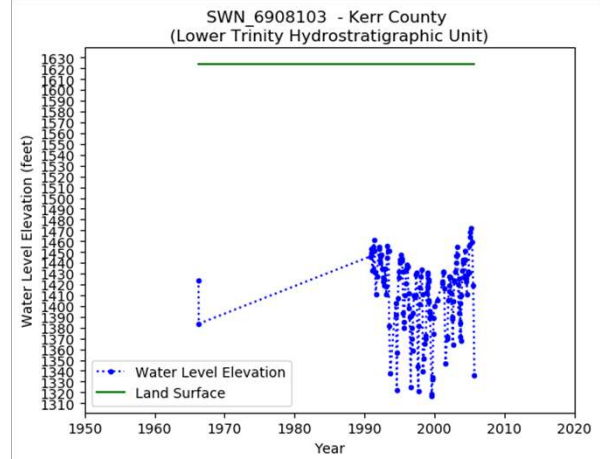
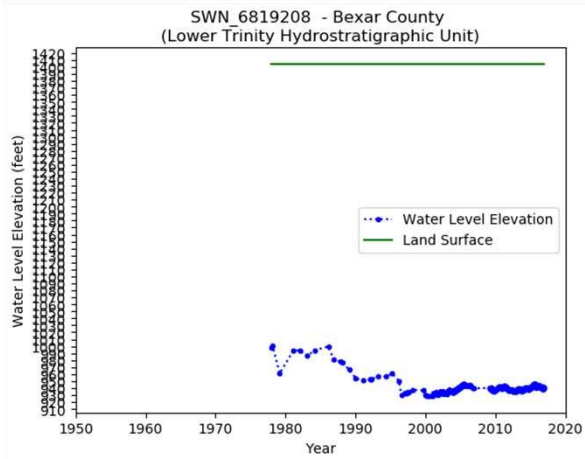
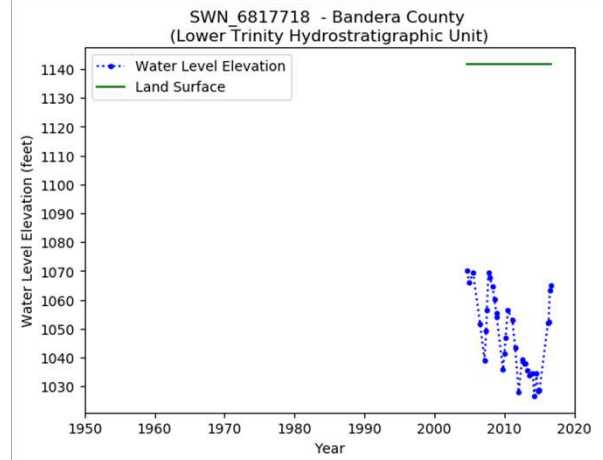
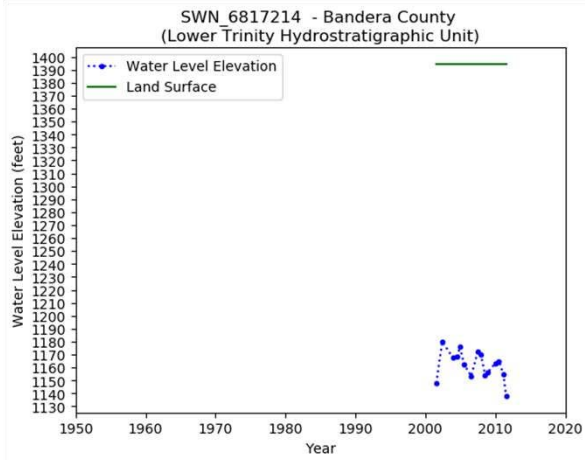

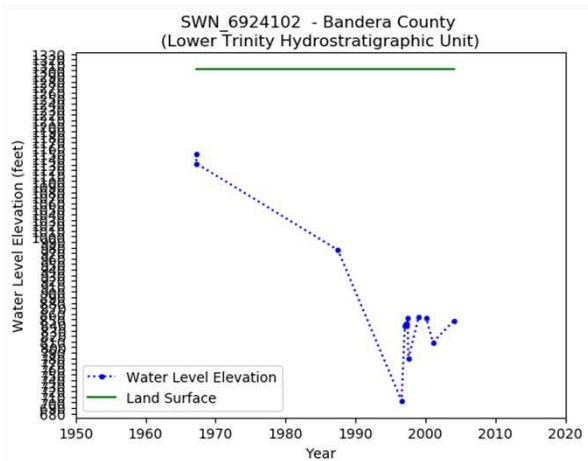

Comment Number	Comment		Action Taken	Response
1	Per Exhibit B, Attachment 1: Please review the report for grammatical errors.	Accepted	Text modified	
2	Per Exhibit C, Attachment 3, Section 4.1 of the contract: Please change all occurrences of "et al." to "and others".	Accepted	Text modified	
3	Per Section II, Article III, Section 4 of the contract: Please ensure that the report complies with accessibility statutes. Please add alternative text to all figures and tables in the report.	Accepted	terms followed	
4	Per Exhibit B, Attachment 3: Please specify whether citations for Rose (2016) are 2016a or 2016b.	Accepted	Text modified	
5	Per Exhibit B, Attachment 1: Please change all occurrences of "Edwards Aquifer" to "Edwards (Balcones Fault Zone) Aquifer to be consistent with TWDB aquifer nomenclature.	Accepted	Text modified	
6	Per Exhibit B, Attachment 3: The numbered report by Mace and others (2000b) supersedes Mace and others (2000a), please delete all references to Mace and others (2000a).	Accepted	Text modified	
7	Per Exhibit B, Attachment 1: Where ever it occurs in the report, please change "Hensel" to "Hensell".	Accepted	Text modified	As noted, the fault displacements came from Hovorka and others (1988). It is not feasible to extract displacement gradients for each fault on each horizon. Offsets for each fault have been presented in the structured horizons provided.
8	Per Section II: Fault displacement data from Hovorka and others (1998) and Fratesi and others (2015) that were used to develop the stratigraphic surfaces are missing from the text and source geodatabase. Please include this data in the final deliverables.	Rejected		
9	Per Exhibit B, Attachment 1: Please change all occurrences of "ft" to "feet".	Accepted	Text modified	
10	Per Exhibit B, Attachment 1: Please the full name of all stratigraphic units in text. For example, "Hensell Formation" instead of "Hensell".	Accepted	Text modified	
11	Per Exhibit B, Attachment 1: Please change all occurrences of "GCD" to "groundwater conservation district".	Accepted	Text modified	
12	Per Exhibit B, Attachment 1: Please spell out units of measure, for example, feet per day instead of ft/day and square feet per day instead of ft2/day.	Accepted	Text modified	

13	Per Exhibit B, Attachment 1: Please use consistent nomenclature for aquifer names, they vary throughout the text.	Accepted	Text modified
14	Per Exhibit B, Attachment 1: Please ensure that the references in the list of references are arranged in alphabetical order by date.	Accepted	Text modified
15	Page iii: Please change "Seal" to "Seals".	Accepted	Text modified
16	Table of Figures: Please add Figure 1.0.1 to the list of figures.	Accepted	Text modified
17	Table of Figures: Please add Figure 2.0.10 to the list of figures.	Accepted	Text modified
18	Table of Figures: Please change "Wermund (1966)" to "Wermund (1996)".	Accepted	Text modified
19	Table of Figure: Please revise the figure numbers for Figures 4.3.1 through 4.3.5 for consistency.	Accepted	Text modified
20	Table of Figures: Please add Figures 4.5.1 through 4.5.14 to the list of figures.	Accepted	Text modified
21	Section 1.0, page 1, paragraph 1: Please change "Figure 1.0" to "Figure 1.0.1"	Accepted	Text modified
22	Section 1.0, page 1, paragraph 1: Please change "... it overlies." to "... it underlies."	Accepted	Text modified
23	Section 1.0, page 1, paragraph 1: Please change "...the Trinity (Hill Country) Aquifer and the Northern Trinity and Woodbine Aquifer." to "... Hill Country and northern portions."	Accepted	Text modified
24	Section 1.0, page 1, paragraph 1: Please change "Ridgeway and Petrini, 1991" to "Ridgeway and Petrini, 1999"	Accepted	Text modified
25	Section 2.0, page 3, paragraph 1: Please change "... 19 counties ..." to "... 14 counties ..."	Accepted	Text modified
26	Section 2.0, page 4, Figure 2.0.11: Please change Figure to 2.0.1.	Accepted	Text modified
27	Section 2.1, page 14, paragraph 1: Please use the same terminology in the text and figures. Please refer to Blackland Prairies and Interior Coastal Plains instead of the Balcones Escarpment and Gulf Coastal Plains, respectively, with appropriate definitions.	Accepted	Text modified

28	Section 2.1, page 14, paragraph 1: Please add publication date to "... Economic Geology".	Accepted	Text modified	
29	Section 2.1, page 14, paragraph 2: Please change " ... contains four ..." to "... contains five ...".	Accepted	Text modified	
30	Section 2.1, page 15, paragraph 1: Please change 2,420 to 2,421 to match legend in Figure 2.1.3.	Accepted	Text modified	
31	Section 2.1, page 16, paragraph 2: Please change the citation from "Soil Staff ..." to "USDA".	Accepted	Text modified	
32	Section 2.2.1, page 29, paragraph 1: Please delete the reference to "smaller aquifers" and instead refer to the subdivisions of the Hill Country portion of the Trinity Aquifer- the upper, middle, and lower Trinity.	Accepted	Text modified	
33	Section 2.2.1, page 29, paragraph 1, line 6: Please clarify using the term "uncomfortably" versus describing an unconformity. If the author is describing an unconformity, please include the type-disconformity, nonconformity, angular unconformity, and so forth.	Accepted	Text modified	
34	Section 2.2.1, page 29, paragraph 1: Please change "Balcones" to "Balcones Fault Zone".	Accepted	Text modified	
35	Section 2.2.1, page 29, paragraph 1: Please specify whether "Rose (2016)" is "a" or "b" as cited in the list of references.	Accepted	Text modified	
36	Section 2.2.2, page 29, paragraph 1: Please cite Figures 2.2.1 and 2.2.8.	Accepted	Text modified	
37	Section 2.2.3, page 30, paragraph 3: For consistency, please refer to the "Hammett Formation" as the "Hammett Shale" as appears in the figures.	Accepted	Text modified	
38	Section 2.2.3, page 30, paragraph 4: Please change references to "Upper Glen Rose Formation" and "Lower Glen Rose Formation" to upper and lower members of the Glen Rose Formation. See Figure 2.2.1.	Accepted	Text modified	
39	Section 2.2.3, page 31, paragraph 2: Please add discussion of other Edwards Group formations such as the Fort Terret, West Nueces, Segovia, and other formations that occur in the Edwards Plateau, Hill Country, and Balcones Fault Zone (see Figure 2.2.1).	Rejected		Edwards is not the focus, citations are included that reference the Edwards Group
40	Section 2.2.4, page 31, paragraph 1: Please remove	Accepted	Text modified	

	reference to the Sabine Arch since it lies outside of the study area.			
41	Section 2.2.4, page 31, paragraph 1: Please add a sentence defining "en echelon faults".	Accepted	Text modified	
42	Section 2.2.4, page 31, paragraph 1: Please change "George, 1952" to "George and others, 1952".	Accepted	Text modified	
43	Section 2.2.4, page 31, paragraph 1: Please specify whether "Rose, 1986" is "a" or "b" as cited in the list of references.	Accepted	Text modified	
44	Section 3.0, page 43, paragraph 1: Please delete "a,b". Section 3.0, page 43, paragraph 2: Please revise the sentence "However, it does not cover ..." to instead state that the 2000 and 2011 models did not cover the entire Hill Country portion of the Trinity Aquifer, excluding parts of the aquifer in parts of Blanco, Burnet, Gillespie, Travis counties in the north and parts of Bandera, Real, and Uvalde counties in the west and did not include the confined parts of the aquifer.	Accepted	Text modified	
45	Section 3.0, page 43, paragraph 2: Please delete "a,b" (twice).	Accepted	Text modified	
46	Section 3.0, page 43, paragraph 3: Please add "/" to Barton Springs/Edwards Aquifer Conservation District.	Accepted	Text modified	
47	Section 3.0, page 44, paragraph 1: Please change "Hooligan" to "Holligan".	Accepted	Text modified	
48	Section 4.1, page 45, paragraph 1: Please specify whether Johnson and others (2010) is "a" or "b".	Accepted	Text modified	
49	Section 4.1, page 45, paragraph 2: Please add a figure showing the location of the Edwards (Balcones Fault Zone) Aquifer.	Accepted	Text modified	
50	Section 4.1, page 46, paragraph 4: Please change "Edwards-Trinity" to "Edwards-Trinity (Plateau)". Please change "Aquifers" to "aquifers" and "ro" to "to".	Addressed	Text modified	Figure reference added.
51	Section 4.1.1, page 46, paragraph 1: In the sentence "We collected (from literature ...", please add the Glen Rose Formation to the list or explain why it was not included.	Accepted	Text modified	
52	Section 4.1.1, page 46, paragraph 1: It is stated that "... stratigraphic picks and unit thickness information from	Accepted	Text modified	added upper and lower Glen Rose
53		Accepted	Text Modified	877 wells were evaluated from various sources, but only 632 wells were used to build

	literature for 877 wells (Figure 4.1.1)." The "Formation_Picks.xls" spreadsheet only contains data for 632 wells and the "Well_Formation_Tops" point feature in the Hill Country Trinity_GDB geodatabase contains a subset of 489 of these wells. Please provide ALL formation picks used to create the hydrostratigraphic surfaces in the required format.			the framework model.
54	Section 4.1.1, page 46, paragraph 1: Please discuss that when picks were extracted from literature that a consistent methodology for interpretation was verified. Mixing stratigraphic and lithologic approaches may and often results with inconsistent variations across the study domain. The assumptions should be documented in the geodatabase to allow modelers the option to test various assumptions.	Accepted	Text modified	Added "stratigraphic" to the sentence so that it is clear that the well correlations were for stratigraphy and not lithology.
55	Section 4.1.1, page 46, paragraph 1: This section refers to Figure 4.1.1 that shows location of wells from literature, raster log, and geophysical log interpretation. Text stated 11 wells with geophysical logs were interpreted; however, it appears only 10 are visible on Figure 4.1.1.	Accepted	Text modified	
56	Section 4.2, page 76, paragraph 2: Please change "'Hill Country Trinity" region" to "Hill Country Trinity region" to be consistent with Figure 4.2.1.	Accepted	Text modified	
57	Section 4.2, page 76, paragraph 2: Please change, "...TWDB extent of the Edwards-Trinity Plateau Aquifer..." to "...TWDB extent of the Edwards-Trinity (Plateau) Aquifer..."	Accepted	Text modified	
58	Section 4.2, page 76, paragraph 2: Please change, "...TWDB extent of the Edwards Balcones Fault Zone Aquifer..." to "...TWDB extent of the Edwards (Balcones Fault Zone) Aquifer..."	Accepted	Text modified	No change made. This information is provided in the two succeeding paragraphs which describe both how previous studies defined the pre-development time period and how the current study defines the pre-development time period.
59	Section 4.2.4, page 80, paragraph 1: Please refine the definition of "pre-development" by including a time period over which pre-development conditions existed.	Rejected		
60	Section 4.2.4, page 80, paragraph 1: Please delete the second sentence in this paragraph. Pre-development conditions are not synonymous with steady-state conditions because seasonal and interannual fluctuations of recharge	Accepted	Text modified	This sentence has been re-worded for clarification.

61	will result in associated water-level and discharge variation. Section 4.2.4 subsection Upper Trinity hydrostratigraphic unit, page 81: please review this paragraph for punctuation and spacing and update as needed. Please remove uppercase Water when used in the middle of a sentence in this section and following sections.	Accepted	Text modified		
62	Section 4.2.82, page 88: Please changes this section number to 4.2.8.2.	Accepted	Text modified		
63	Section 4.3.1, page 122, paragraph 3: Please add (1) a reference for the equation, and (2) an equation number.	Accepted	Text modified		
64	Section 4.3.1, pages 123 to 125: please remove page breaks on page 123 and 124 and adjust table of contents as needed.	Accepted	Formatting adjusted		
65	Section 4.3.1, page 125, paragraph 1: please check grammar in this paragraph and adjust as needed.	Accepted	Text modified		
66	Section 4.3.2, page 125: Please add a figure that sums up both diffused and focused recharge to the aquifer.	Accepted	incorporated into Fig 4.3.7		
67	Section 4.3.2, page 125, paragraph 2: Please extend the spatial distribution of the focused recharge analysis to include the entire study area to be consistent with the diffused recharge analysis.	Accepted	Figure modified		
68	Section 4.3.2, page 125, paragraph 3: Please add (1) a reference for the equation, and (2) an equation number.	Accepted	Text modified		
69	Section 4.4.1, page 136, paragraph 2: Please change "Arnold et al. (1996, 1999)" to "Arnold and others (1995) and Arnold and Allen (1999)".	Accepted	Text modified		
70	Section 4.4.1, page 137, paragraph 3: Please add a reference for the inter-formational flow program results.	Accepted	Text modified		
71	Section 4.4.2, page 137, paragraph 1: Please note that in addition to the 1950s and mid-1960s, Lake Travis also had large water-level declines in the early 2010s.	Accepted	Text modified		
72	Section 4.4.2, page 137, paragraph 1: Please change "fig. 36" to Figure "4.4.7".	Accepted	Text modified		
73	Section 4.4.2, page 137, paragraph 1: Please add discussion of Lake Buchanan, Lake Amistad, Lake Austin, Inks Lake, and Lake LBJ.	Accepted	Text modified		

74	Section 4.5, page 154, paragraph 7: Please delete "..., or units of ft ⁻¹ ".	Accepted	Text modified
75	Section 4.5.7, page 161, paragraph 2: Please change "High Plains" to "Plateau".	Accepted	Text modified
76	Section 4.5.7, page 162, paragraph 2: Please change "High Plains" to "Plateau".	Accepted	Text modified
77	Section 4.5.7, page 162, paragraph 3: Please change "High Plains" to "Plateau".	Accepted	Text modified
78	Section 4.6.1, page 180, paragraph 2: Please add "Table 4.6.1" at the end of the last sentence.	Accepted	Text modified
79	Section 4.6.2.1.1, page 181, paragraph 1: Please change "Table 4.6.1" to "Table 4.6.2".	Accepted	Text modified
80	Section 4.6.2.1.1, page 181, paragraph 1: Please specify the time period for pre-development water-elevations.	Accepted	Text modified
81	Section 4.6.2.1.2, page 182, paragraph 3: Please change "Table 4.6.1" to "Table 4.6.3".	Accepted	Text modified
82	Section 4.6.2.2, page 183, paragraph 1: Please delete "(pgd)".	Accepted	Text modified
83	Section 4.6.2.4, page 186, paragraph 2: Please change "Table 4.6.3" to "Table 4.6.4".	Accepted	Text modified
84	Section 4.6.2.6, page 189, paragraph 2: Please change "Figure 4.1.10" to "Figure 4.6.10".	Accepted	Text modified
85	Section 4.6.2.6, page 189, paragraph 3: Please change "Figure 4.1.11, Figure 4.1.12, and Figure 4.1.13" to "Figures 4.6.11 through 4.6.13".	Accepted	Text modified
86	Section 4.7, page 212, paragraph 1: Please correct "TWDB, 2018".	Accepted	Text modified
87	Section 4.7, page 212, paragraph 1: Please change "WQP, 2018" to "NWQMC, 2017".	Accepted	Text modified
88	Section 4.7.1, page 212, paragraph 1: Please revise the second sentence. "The distribution of ..." to clarify what is meant by Trinity Aquifer. The data clearly do not match with the data in Figures 4.7.2 through 4.7.4 which represent the upper, middle, and lower portions of the Trinity Aquifer.	Accepted	Text modified
89	Section 4.7.1, page 212, paragraph 1: The statement "...generally less than 500 mg/L in updp and western portions	Accepted	Text modified

	of the revised model area but increases downdip ..." applies to the data in Figure 4.7.1 but not Figures 4.7.2 through 4.7.4 where there are no apparent spatial trends, especially in the middle and lower Trinity hydrostratigraphic units.		
90	Section 4.7.1, page 212, paragraph 1: The sentence "The median ...", please change "300-500 mg/l" to "250 or 200-500 mg/l".	Accepted	Text modified
91	Section 4.7.1, page 212, paragraph 2: Please change "calcium-magnesium carbonate" to "calcium-carbonate to calcium-magnesium carbonate".	Accepted	Text modified
92	Section 4.7.1, page 212, paragraph 2: There is only a few sodium-chloride samples in Figure 4.7.6, most of the high sodium groundwater samples are sodium-carbonate. Please change "...sodium chloride in areas ..." to "... sodium-chloride and sodium-carbonate in areas ...".	Accepted	Text modified
93	Section 4.7.1, page 212, paragraph 2: Please change "... sulfate and chloride concentrations ..." to "... increasing sulfate and chloride concentrations ...".	Accepted	Text modified
94	Section 4.7.1, page 212, paragraph 2: Please investigate whether the trends observed are due to wells only penetrating the Edwards Group portion of the Edwards-Trinity (Plateau) Aquifer and revise the text as appropriate.	Accepted	Text modified
95	Section 4.7.3, page 213, paragraphs 2 and 3: Please delete these paragraphs because they do not contribute new information.	Accepted	Text modified
96	Section 4.7.3, page 214, paragraph 1: Figure 4.7.11 shows overlapping stable oxygen and hydrogen isotope composition of groundwater in the Trinity and Edwards (Balcones Fault Zone) aquifers as indicated by Darling (2016). This figure only indicates mixing of groundwater from the Edwards (Balcones Fault Zone) Aquifer with surface water from Lake Medina, not with the Trinity Aquifer. Please delete this paragraph along with Figure 4.7.11.	Accepted	Text modified
97	Section 4.7.3, page 214, paragraph 2: This text adds no useful information about interaction between the Trinity and Edwards (Balcones Fault Zone) aquifers. Please delete it.	Accepted	Text modified
98	Section 5.1, page 226, paragraph 1: Please change " ...	Accepted	Text modified

	interformational recharge ... " to "... inter-formational inflow ...			
99	Section 5.1, page 226, paragraph 2: Please change "Trinity Formation" to "Trinity Aquifer".	Accepted	Text modified	
100	Section 5.1, page 227, paragraph 1: Please delete the last four sentences in this paragraph.	Accepted	Text modified	
101	Section 5.1, page 227, paragraphs 2 through 5: Please delete these paragraphs.	Accepted	Text modified	
102	Section 5.2: Please delete this section and associated figures and references.	Accepted	Text modified	
103	Section 5.3, page 238, paragraph 1: Please add Figure 5.1.7 to the sentence that begins with "The cross sections were prepared ...".	Accepted	Text modified	
104	Section 5.3, page 239, paragraph 2: Please change "5.3.15" to "5.3.6" where it appears in the text.	Accepted	Text modified	
105	Section 5.3, page 239, paragraph 2: Please change "(i) TWDB" to "(i) TWDB groundwater database".	Accepted	Text modified	
106	Section 5.3, page 239, paragraph 3: Please delete this paragraph.	Accepted	Text modified	
107	Section 5.3, page 239, paragraph 4: Please delete this paragraph.	Accepted	Text modified	
108	Section 5.3, page 240, paragraph 1: Please delete this paragraph.	Accepted	Text modified	
109	Section 5.3, page 240, paragraphs 2 and 3: Please move these paragraphs to Section 4.6.1.	Accepted	Text modified	
110	Section 5.3, page 240, paragraph 4: Please delete this paragraph.	Accepted	Text modified	
111	Section 5.5: Please delete this section.	Accepted	Text modified	
112	Section 5.6: Please move the text and figure in this section to Section 4.2.	Accepted	Text modified	
113	Section 6.0: Please add Sharp and Banner (1997) to the list of references.	Accepted	Reference added	
114	Section 6.0: Please add Johnson and others (2002) to the list of references.	Accepted	Reference added	

115	Section 6.0: Please add TWDB (2009) to the list of references.	Accepted	Reference added	
116	Section 6.0: Please include the list of authors in the reference for Fyre and others (1984).	Accepted	Reference modified	
117	Section 6.0: Please add the year (2018) after the author to the reference for Soil Survey ... (2018).	Accepted	Reference modified	
118	Section 6.0: Please change the author "Soil Survey ..." to "United States Department of Agriculture".	Accepted	Reference modified	
119	Section 6.0: Please add TPWD (1984) to the list of references.	Accepted	Reference added	
120	Section 6.0: Please add Lozo and Stricklin (1956) to the list of references.	Accepted	Reference added	
121	Section 6.0: Please add Inden (1974) to the list of references.	Accepted	Reference added	
122	Section 6.0: Please add Abbott (1966) to the list of references.	Accepted	Reference added	
123	Section 6.0: Please add Morris and others (2014) to the list of references.	Accepted	Reference added	
124	Section 6.0: Please add Laubach and Jackson (1990) to the list of references.	Accepted	Reference added	
125	Section 6.0: Please add Murray (1956) to the list of references.	Accepted	Reference added	
126	Section 6.0: There are two references that can be cited as Johnson and others (2010). Please cite as "a" and "b" and change the citations in the text.	Accepted	Text modified	
127	Section 6.0: Please list all of the authors in Farlow and others (2006).	Accepted	Reference modified	
128	Section 6.0: Please add Hill (1891) to the list of references.	Accepted	Reference added	
129	Section 6.0: Please delete Mace and others (2000a), change Mace and others (2000b) to (2000) and make appropriate changes to the text.	Accepted	Reference deleted	
130	Section 6.0: Please add Johnson and others (2002) to the list of references.	Accepted	Reference added	

131	Section 6.0: Please add Schultz (1992) to the list of references.	Accepted	Reference added
132	Section 6.0: Please add Maclay and Small (1983) to the list of references.	Accepted	Reference added
133	Section 6.0: Please add Clark (2000) to the list of references.	Accepted	Reference added
134	Section 6.0: Please add TNRIS (1997) to the list of references.	Accepted	Reference added
135	Section 6.0: Please add Zahm and others (1998) to the list of references.	Accepted	Reference added
136	Section 6.0: Please add Hayes (2000) to the list of references.	Accepted	Reference added
137	Section 6.0: Please add Mace (2011) to the list of references.	not found	none
138	Section 6.0: Please add Allan (1989) to the list of references.	Accepted	Reference added
139	Section 6.0: Please add Maclay (1989; 1995) to the list of references.	Accepted	Reference added
140	Section 6.0: Please add Ferrill and Morris (2001) to the list of references.	Accepted	Reference added
141	Section 6.0: Please add Arnow (1963) to the list of references.	Accepted	Reference added
142	Section 6.0: Please add Caine and others (1996) to the list of references.	Accepted	Reference added
143	Section 6.0: Please add Knipe (1997) to the list of references.	Accepted	Reference added
144	Section 6.0: Please add Yielding and others (1997) to the list of references.	Accepted	Reference added
145	Section 6.0: Please add Ferrill and Morris (2003) to the list of references.	Accepted	Reference added
146	Section 6.0: Please add Finkbeiner and others (1997) to the list of references.	Accepted	Reference added
147	Section 6.0: Please add Ferrill and others (1999b) to the list of references.	Accepted	Reference added
148	Section 6.0: Please add Antonelli and Aydin (1994) to the list of references.	Accepted	Reference added

	of references.			added	
149	Section 6.0: Please add Mayer and Sharp (1998) to the list of references.	Accepted		Reference added	
150	Section 6.0: Please add Ferrill and others (2000) to the list of references.	Accepted		Reference added	
151	Section 6.0: Please add Fisher (1983) to the list of references.	Accepted		Reference added	
152	Section 6.0: Please add Fratesi and others (2013) to the list of references.	Accepted		Reference added	
153	Section 6.0: Please spell out "TWDB" where it occurs in the list of references.	Accepted		Reference modified	
154	Section 6.0: Please add USGS (2018) to the list of references.	Accepted		Reference modified	
155	Section 6.0: Please delete one occurrence of Arnold and others (1995).	Accepted		Reference deleted	
156	Section 6.0: Please add TAMU (2018) to the list of references.	Accepted		Reference added	
157	Section 6.0: Please add Kuniandy (1990) to the list of references.	Accepted		Reference added	
158	Section 6.0: Please add Guyton and Associates (1958; 1970) to the list of references.	Accepted		Reference added	
159	Section 6.0: Please add Espey Huston and Associates (1982; 1989) to the list of references.	accepted		Reference added	
160	Section 6.0: Please delete TWDB (2017) from the list of references.	Accepted		Reference added	
161	Section 6.0: Please add Fry and others (2006) to the list of references.	Accepted		Reference added	
162	Section 6.0: Please spell out "BSEACD".	Accepted		Reference modified	
163	Section 6.0: Please add WQP (2018) to the list of references.	Accepted		Reference added	
164	Section 6.0: Please add Green and others (2008) to the list of references.	Accepted		Reference added	
165	Section 6.0: There are two Green and others (2012)	Accepted		Reference	

	references in the list of references. Please number them a and b and correct the citations in the text.		modified
166	Section 6.0: Please add Lowry (1955) to the list of references.	Accepted	Reference added
167	Section 6.0: Please add Bader and others (1993) to the list of references.	Accepted	Reference added
168	Section 6.0: Please add Tremallo and others (2014) to the list of references.	Accepted	Reference added
169	Section 6.0: Please add publication date and report number to "Texas Bureau of Economic Geology".	Accepted	Reference modified
170	Section 6.0: Please delete one of Tucker (1962a or 1962b) and revise the citation in Table 2.2.1.	Accepted	Reference modified
171	Section 6.0: The following references in the list of references do not appear in the text. Please delete them.	Accepted	References deleted
	· Anderson and Woessner (1992)		
	· Bateman and Konen (1977)		
	· Fisher and Rodda (1967)		
	· Heitmuller and Reece (2003)		
	· Houston and others (2003a; 2003b; 2003c)		
	· Kromann (2015)		
	· Land and others (1983)		
	· Lindgren and others (2009)		
	· Manford and others (1960)		
	· Slade and others (1982)		

	<ul style="list-style-type: none"> Stepchinski and others (2017) 			
	<ul style="list-style-type: none"> TWDB (2001) 			
	<ul style="list-style-type: none"> TWDB (2017c) 			
	<ul style="list-style-type: none"> USGS (2016) 			
	<ul style="list-style-type: none"> USGS (1965) 			
172	Figure 1.0.1: Please revise to reflect current major aquifer boundaries.	Accepted	Figure modified	
173	Figure 2.0.1: Please change "Figure 2.0.2.11" to "Figure 2.0.1".	Accepted	Figure modified	
174	Figure 2.0.3: Please spell out "RWPAs". Please remove Coastal Bend and Rio Grande RWPAs from this figure.	Accepted	Figure modified	
175	Figure 2.0.4: Please remove GMA 15 and 16 from this figure. Please make sure color for Groundwater Management Area 8 in legend is the same color used in the figure. Please spell out groundwater management areas.	Accepted	Figure modified	
176	Figure 2.0.5: Please spell out "groundwater conservation districts", "UWCDs", and "CDs" or add to caption. Please use patterns to distinguish the Edwards Aquifer Authority from overlapping groundwater conservation districts.	Accepted	Figure modified	
177	Figure 2.0.10: Please remove the aquifers not mentioned in the text-Dockum, Sparta, and Yegua-Jackson aquifers.	Accepted	Figure modified	
178	Figure 2.1.1: Please change "Wermund (1966)" to "Wermund (1996)".	Accepted	Figure modified	
179	Figure 2.1.7: This figure is not cited in the text. Please revise the text to discuss the information in this figure.	Accepted	Text added	
180	Figures 2.1.8, 2.1.9, and 2.1.10: Please consider using the same scale for graphs in each figure so the reader can easier compare data in all of graphs posted.	Rejected		It was decided to retain current scales to illuminate higher resolution changes
181	Figure 2.1.11, Please consider numbering or adding some variation with hatching to distinguish between categories.	Accepted	Figure modified	

182	Figure 2.1.12: Please change the citation from "Soil Staff ..." to "USDA".	Accepted	Figure modified	
183	Figure 2.2.1: In the hydrostratigraphic section of the figure, please replace the Trinity stratigraphic units with the hydrostratigraphic units of the Trinity Aquifer-Upper, Middle, and Lower Trinity.	Accepted	Figure modified	
184	Figure 2.2.1: Please specify whether Rose (2016) is "a" or "b" as appears in the list of references.			
185	Figure 2.2.2: Please change "Balcones" to "Balcones Fault Zone".	Accepted	Figure modified	
186	Figure 2.2.4: Please add Devils River Trend to this figure. Please use the same terminology in both the figure and text. For example, "Ouachita-Marathon fold thrust belt" in the text and "Ouachita-Marathon Thrust Front" appears in the figure.	Rejected		Devils river trend is a facies change not a structural feature. It is shown on other figures. Ouachita-Marathon fold thrust belt refers to the entire orogenic system; the line on the figure represents the thrust front as described.
187	Figure 2.2.5: Please change "Figure 2.2.1" to "Figure 2.2.2".	Accepted	Figure modified	
188	Figure 2.2.6: Please change "Figure 2.2.1" to "Figure 2.2.2".	Accepted	Figure modified	
189	Figure 2.2.6: Cross-section is several miles away from the axis of the San Marcos Arch. Please "San Marcos Arch" from this figure.	Rejected		The labels correlate to the stratigraphic column. San Marcos Arch label represents San Marcos Arch region stratigraphy not the actual structure.
190	Figure 2.2.7: Please change "Figure 2.2.1" to "Figure 2.2.2".	Accepted	Figure modified	
191	Figure 2.2.7: Please specify whether Rose (2016) is "a" or "b" as appears in the list of references.	Accepted	Caption modified	
192	Figure 4.1.2: Text infers this figure was from (Hovorka and others, 1998). If so, please add this reference to the caption.	Accepted	Caption modified	
193	Figures 4.1.2 and 4.1.5: Please provide feature class within the Geology Feature Dataset of the fault data attributed with fault throw displacements from Hovorka et al. (1988) discussed within Fault Model text on pages 46 and shown in the figures on pages 50 and 53.	Rejected		As noted, the fault displacements came from Hovorka and others (1988). It is not feasible to extract displacement gradients for each fault on each horizon. Offsets for each fault have been presented in the structured horizons provided.
194	Figures 4.1.3: Please provide feature class within the Geology	Rejected		The model described in Fratesi et al was not

	Feature Dataset of the fault data attributed with fault throw displacements from Fratesi et al. (2015) discussed within Fault Model text on page 46 and shown in the figure on page 51.			part of this project and was only included to show a better representation of faults.
195	Figure 4.1.5: Please correct typographical errors in this figure.	Accepted	Figure modified	
196	Figure 4.1.8: Please use classified ranges to better indicate top elevations of the top the stratigraphic unit.	Accepted	Figure modified	
197	Figure 4.1.10: Please use classified ranges to better indicate top elevations of the top the stratigraphic unit.	Accepted	Figure modified	
198	Figure 4.1.12: Please use classified ranges to better indicate top elevations of the top the stratigraphic unit.	Accepted	Figure modified	
199	Figure 4.1.14: Please use classified ranges to better indicate top elevations of the top the stratigraphic unit.	Accepted	Figure modified	
200	Figure 4.1.16: Please use classified ranges to better indicate top elevations of the top the stratigraphic unit.	Accepted	Figure modified	
201	Figure 4.1.18: Please use classified ranges to better indicate top elevations of the top the stratigraphic unit.	Accepted	Figure modified	
202	Figure 4.1.20: Please use classified ranges to better indicate top elevations of the top the stratigraphic unit.	Accepted	Figure modified	
203	Figure 4.1.22: Please use classified ranges to better indicate top elevations of the top the stratigraphic unit.	Accepted	Figure modified	
204	Figure 4.1.24: Please use classified ranges to better indicate top elevations of the top the stratigraphic unit.	Accepted	Figure modified	
205	Figure 4.2.6: Please use separate y-axes for the number of water-level measurements and number of wells.	Accepted	Figure modified	
206	Figure 4.2.7: Please use separate y-axes for the number of water-level measurements and number of wells.	Accepted	Figure modified	
207	Figure 4.2.9: There are no contours over a large portion of the aquifer outcrop. This is inconsistent with Jones and others (2011) and Anaya and Jones (2009). Please revise this figure to fill in the gaps.	Accepted	Figure modified	
208	Figures 4.2.24 through 4.2.29: Please provide the time series data used to create these hydrographs.	Accepted	Data added to deliverable folder	

209	Figure 4.3.4: Please change caption from "Distribution of recharge ..." to "Distribution of diffuse recharge ...".	Accepted	Caption modified	
210	Figure 4.3.4: Please change the units from feet per day to inches to be consistent with Figures 4.3.7 and 4.3.8.	Accepted	Units changed to inch/month	
211	Figure 4.3.5: Please change the units from feet per day to inches to be consistent with Figures 4.3.7 and 4.3.8.	Accepted	Units changed to inch/month	
212	Figure 4.4.7: Please correct the captions of the pages 151 through 153.	Accepted	Caption modified	
213	Figure 4.4.7: Please change the graph title from "Austin" to "Lake Austin".	Accepted	Figure modified	
214	Figure 4.5.13: Please use larger font text in the graphs.	Accepted	Figure modified	
215	Figure 4.7.1: Please use the same symbol with contrasting colors for each category in this figure. Where points are clustered, especially in the eastern part of the study area, it is difficult to distinguish between the 1,000-3,000 mg/l and 3,000-10,000 mg/l categories.	Accepted	Figure modified	
216	Figure 4.7.1: Please revise to reflect required changes to the text.	Accepted	Figure modified	
217	Figure 4.7.2: Please use the same symbol with contrasting colors for each category in this figure.	Accepted	Figure modified	
218	Figure 4.7.3: Please use the same symbol with contrasting colors for each category in this figure.	Accepted	Figure modified	
219	Figure 4.7.4: Please use the same symbol with contrasting colors for each category in this figure.	Accepted	Figure modified	
220	Figure 5.1.1: Please add the outline of the Hill Country portion of the Trinity Aquifer.	Accepted	Figure modified	
221	Figure 5.1.2: This is identical to Figure 2.2.2. Please delete this figure and reference Figure 2.2.2.	Accepted	Figure deleted	
222	Figure 5.1.6: This figure show groundwater flow across a no-flow boundary, please revise.	Accepted	Figure modified	
223	Figure 5.1.9: Please delete the conceptual model boundary.	Accepted	Figure modified	

224	Figure 5.3.1: Please renumber and move this figure (Figure 5.4.1).	Accepted	Figure renumbered	
225	Figure 5.3.2: Please change "TWDB" to "TWDB groundwater database".	Accepted	Figure modified	
226	Figure 5.3.2: Please add an explanation for the abbreviations used in the figure (UGR, HEN, CCK, ...).	Accepted	Figure modified	
227	Figure 5.6.1: Please change the reference from "Jones et al., 2011" to "Jones, 2011"-Jones, I. C., 2011, Interaction between the Hill Country portion of the Trinity and Edwards aquifers: model results: in Gary, M. O., Gary, R. H., and Hunt, B. B., eds., Interconnection of the Trinity (Glen Rose) and Edwards aquifers along the Balcones Fault Zone and related topics: Karst Conservation Initiative, held February 17, 2011, p. 36-37.	Accepted	Figure modified	
228	Table 2.2.1: Please change "George (1952)" to "George and others (1952)".	Accepted	Table modified	
229	Table 2.2.1: Please change "Johnson et al. (2010)" to "Johnson and others (2010a or b)" as appropriate.	Accepted	Text modified	
230	Table 2.2.1: Please specify whether Tucker (1962) is "a" or "b".	Accepted	Text modified	
231	Per Article III, number 3, of the contract 1648302061: "one electronic copy of all the related documented source and derived data in the appropriate geodatabase(s)": Please include missing PETREL datasets.	Accepted	Petrel Folder added to deliverable	The full petrel project will be added to the deliverable. Not all Petrel files can be converted to ArcGIS format.
232	Per Exhibit B, Scope of Work, Task 4, Scope deliverables, page 5 of 14: "Three software packages will be used for developing the hydrostratigraphic framework model: (i) Microsoft Excel 2010, (ii) ESRI ArcGIS, and (iii) Schlumberger PETREL.". Please provide the PETREL data files used to construct the hydrostratigraphic framework model.	Accepted	Petrel Folder added to deliverable	The full petrel project will be added to the deliverable. All files used to construct the framework model are included in the Petrel project.
233	Per Exhibit B, Scope of Work, Task 4, Scope deliverables, page 3 of 14: "Geophysical log interpretation will be central to providing information relating to the upper and lower Trinity Formation boundaries and fault locations for each hydrogeological framework model layer. Geophysical logs will be accessed from the BRACS database, the Texas Commission for Environmental Quality (TCEQ) Public Works	Rejected	none	Per Exhibit B, Scope of Work, Task 4, Scope deliverables, the recommended sources were included in compilation of geophysical logs. It is not feasible at this point in time to create a file with the sources for all of the logs evaluated as a part of the project.

234	<p>Systems records, the existing dataset of geophysical logs for the Trinity (Hill Country) Aquifer GAM, Texas Railroad Commission Q-logs, the Bureau of Economic Geology (BEG) Subsurface Library, and logs supplied via an agreement with IHS Global Well Log." Please provide a file or look-up table to determine the source of the logs used for the framework surface picks.</p> <p>Per Exhibit B, Scope of Work and Attachment 2, Section 1.2, Data deliverables, page 2 of 4: "All datasets used for GAM projects shall include metadata that documents the content, data structure, source(s), date(s), quality, and other characteristics of the data within the geodatabases.": please include metadata documentation for all Microsoft Excel Workbooks/Spreadsheets and all GIS data sets within the geodatabase(s) including attribute field descriptions and units of measure for numeric values where applicable and code/categorical descriptions for attribute fields with classification information.</p>	Accepted	
235	<p>TWDB staff reviewed the stratigraphy by selecting a central area of the study (Kendall, Comal, Bexar, and Hays Counties), where the geology is well documented and can in part be verified by a third party study (Wierman and others, 2010). Based on the review of 65 wells with 318 correlations, 155 picks were reasonable. The other half contained 87 picks that were more than 100 feet off.</p> <p>11010 HWY 46</p>	Addressed	<p>Much of the science in determining formation picks from imperfect data (i.e., wells of limited or poor quality, projecting literature data, etc.) relies on professional judgement. The project team acknowledges that some variation in determining formation picks will result when different qualified parties interpret data differently. Variations between the project team's formation picks and formation picks of others have been determined to not materially change either the formation surfaces or the conceptual interpretation of the hydrogeology of the study area. These variations in formation pick designations are reflective of differences of geological interpretation and are not indicative of a study wide problem with the stratigraphic correlations.</p> <p>Please see Response 235B</p>

37800	Addressed		Please see Response 235B
43757	Addressed		Please see Response 235C
53272	Addressed		Please see Response 235B
55589	Addressed		Please see Response 235A
55623	Addressed		Please see Response 235B
83033	Addressed		Please see Response 235B
CHECK RANCH 1	Addressed		Please see Response 235B
Pahl Thomas	Addressed		
ROGERS RANCH 1	Addressed		Please see Response 235B
16766	Addressed		Please see Response 235B
37806	Addressed		Please see Response 235B
5759901_check	Addressed		Please see Response 235B
53273	Addressed		Please see Response 235B
55593	Addressed		Please see Response 235A
55626	Addressed		Please see Response 235A
ADAM C A WI-3	Addressed		Please see Response 235B
GAILOWELL3	Addressed		Please see Response 235B

R W ANDERSON #1	Addressed	Please see Response 235B
TALLEY JAMES HADY 1	Addressed	Please see Response 235B
34394	Addressed	Please see Response 235B
42769	Addressed	Please see Response 235B
53148	Addressed	Please see Response 235B
55484	Addressed	Please see Response 235A
55597	Addressed	Please see Response 235A
83030	Addressed	Please see Response 235B
AY-68-27-5	Addressed	Please see Response 235B
Holy Archangels Greek Orthodox Monastery	Addressed	Please see Response 235B
Rebecca Creek Ranch 1	Addressed	Please see Response 235B
13 picks were above the well log:	Addressed	Please see Response 235D
37806	Addressed	Repeated well from above
53149	Addressed	Please see Response 235B
ELLISON 1	Addressed	Please see Response 235B
EWERT 1	Addressed	Please see Response 235B
THEIS ADOLF 1	Addressed	Please see Response 235B

	62 picks were below the log	Addressed		Please see Response 235D
	33501	Addressed		Please see Response 235B
	53149	Addressed		Repeated well from above
	55467	Addressed		Please see Response 235A
	55525	Addressed		Please see Response 235A
	55590	Addressed		Please see Response 235A
	55623	Addressed		Repeated well from above
	AY-68-27-1	Addressed		Please see Response 235B
	48666	Addressed		Please see Response 235B
	55464	Addressed		Please see Response 235A
	55484	Addressed		Repeated well from above
	55570	Addressed		Please see Response 235A
	55597	Addressed		Repeated well from above
	55628	Addressed		Please see Response 235A
	AY-68-27-5	Addressed		Please see Response 235B
	55656	Addressed		Please see Response 235A
	55465	Addressed		Please see Response 235A

55522		Addressed	Please see Response 235A
55575		Addressed	Please see Response 235A
55601		Addressed	Please see Response 235A
83023		Addressed	Please see Response 235B
	Holy Archangels Greek Orthodox Monastery	Addressed	Repeated well from above
	Please provide geological justification for these anomalous correlations and explain why they are not indicative of a study wide problem with the stratigraphic correlations.	Addressed	Please see Responses 235A, 235B, and 235C
236	There are 665 stratigraphic picks in the file "Formation_Picks.xls" that are below the total depth of the wells they are associated with. Please detail the method/methods used to create these stratigraphic picks.	Accepted	Stratigraphic picks below the total depth of the well were inferred based on formation thicknesses from nearby wells and/or published regional thicknesses from literature
237	Based on the data deliverables provided, it appears that many formation picks were obtained by determining the values of existing surfaces where they intersected well locations. Please indicate if this assumption is correct or not. Please also provide justification for using this method. Based on Figure 4.1-5, well tops would be created by "using existing picks from literature or creating new picks from log signatures" and then "compared to geophysical log signatures and published literature for thickness and depositional environment".	Addressed	Your assumption is correct. Formation picks at wells with no log or no log at the subject depth were determined by projecting surfaces through the well location.
238	Please provide all formation picks in correct data format. Each file entry should contain a unique well identifier, stratigraphic name, depth in well, source of data, and whether depth was verified on a: 1) geophysical well log, 2) drillers log, 3) cross-section (provide publication reference), 4) other (provide details).	Addressed	A total of 4,529 formation picks were determined during the project. Information gathered at the time was believed to be consistent with the requirements of the project. It is not reasonable or feasible to re-establish this data base at the conclusion of the project.
239	Please explain the geologic justification for picking the Cow Creek Limestone at a depth of 827 feet in BRACS well#55540. This correlation differs by 185 feet from the Cow Creek Limestone pick as published in (Wierman and others,	Addressed	These BRACs wells are not included in the formation picks database of this project

240	2010). Please explain the geologic justification for picking the Cow Creek Limestone at a depth of 325 feet in BRACS well#55460. This correlation differs by 485 feet from the Cow Creek Limestone pick as published in (Wierman and others, 2010). Please explain why these erroneous picks are not indicative of a study wide problem with the stratigraphic correlations.	Accepted		Same as comment 236: Stratigraphic picks below the total depth of the well were inferred from formation thicknesses from nearby wells and/or published regional thicknesses from literature.
241	Please explain why 123 wells in the file "Formation_Picks.xls" have correlations below the total depth of these wells. Provide details on how these "picks" were made and provide the supporting technical data. Some examples include BRACS wells (33020, 36585, 39063, 43756, 50271, 53273, 55590, and 55662). Please submit all well related data in BRACS Database format.	Rejected		Data format used was the one understood from the scope of work In some areas there was minimal well control, but elsewhere in the study area there was sufficient well control to interpolate an accurate surface. Please see figure regarding workflow to clarify procedure used to create hydrostratigraphic surfaces.
242	Please provide details on the methods and data that was used to model stratigraphic surfaces in down-dip areas where there was no well control available.	Accepted		
243	Please ensure that each feature dataset and class has associated metadata including summary, description, credits, and descriptions of each field in the attribute data.	Accepted		check all metadata
244	Please add the Fault feature class that appear in Figure 4.1.2 along with the associated fault displacement data.	Addressed	See explanation	Faults in this figure are the GAT faults in the study area from the Faults_Combined feature class in the Geology feature dataset. Fault displacement gradients can be found in Hovorka et al. (1998) figure 5.
245	Please delete the edwardsop grid that is outside of the geodatabase.	Accepted	modified	
246	Please edit 00_list_of_contents.txt replacing out of date information.	Accepted	modified	
247	Please add the climatic classification regions that appear in Figure 2.1.4 to the geodatabase.	Accepted	modified	
248	Please add monthly PRISM temperature data to the geodatabase.	Accepted	modified	Monthly Rasters added to Geodatabase in ClimatePrismTemp raster catalogue

249	Please add the average annual precipitation data for the study area to the geodatabase.	Accepted	Metadata added to appropriate feature	The Ave Annual Precip for 1980-2015 exists in the DirectRecharge_PrismCells_Polygons feature under the Recharge feature dataset. The average annual precip in inches/month is in field AveInchesP
250	GAM_SRCDATA_v3: Please delete the last paragraph description and replace it with Southwest Research Institute contact information.	Accepted	Metadata added to appropriate feature	
251	Boundary: Please delete the ConceptualModelBoundary feature class.	Accepted	Database modified	
252	Boundary: Please replace feature classes County-clip and TXDOT_counties with feature classes provided by TWDB.	Accepted	Database modified	
253	Climate: LakeEvapQuads does not contain the average annual lake evaporation data shown in Figure 2.1.10. Please revise.	Accepted	Added to Database	
254	Climate: Vegetation does not contain the data shown in Figure 2.1.11. Please revise.	Addressed		Vegetation feature is located in the Conservation Feature Dataset
255	SubSurfaceHydro: Please replace Major_Aquifers and Minor_Aquifers with current versions of the major and minor aquifer boundaries.	Accepted	Database modified	
256	Transportation: Please delete TXDOT_Routes. It was not used in this project.	Accepted	Database modified	
257	Transportation: Please clip NHS_2013_11 to at most the Texas state boundaries. Also, please report lines that are not roads.	Accepted	Feature class modified	
258	Please add a metadata (readme) file to each folder explaining the contents of that folder and including a list of all files in the folder.			
259	Figures: Please delete 4.1.7_Formation_TopL_FlowChart.jpg Figures: Please revise the Excel file. 4.4.2 Hill Country TrinityStreamBaseFlowProcessed.xlsm. This file should only contain the hydrographs that appear in Figure 4.4.2. Additionally, it would be useful to move the graphs to separate sheets.	Accepted	Jpg deleted	The number of hydrographs is too large to document in their entirety in the report. However, future users may require the baseflow separation results for the other gage stations. Accordingly we reject this request.
260		Rejected	No action	

261	Figures: File(s) for Figure 4.4.7 are missing from this folder. Please include them in the final deliverables.	Accepted	Figure added to deliverables
262	Figures: Please rename the png files for Figures 4.6.3 through 4.6.13 to be consistent with the other files in this folder.	Accepted	
263	Figures: Figures 4.7.5, 4.7.7, 4.7.8, 4.7.10, and 4.7.11 are missing. Please include them in the final deliverables.	Accepted	Figures added to deliverables
264	SSUGRO SOILS_TX_[2006-07-06]: Please rename this folder "SSURGO SOILS_TX_[2006-07-06]".	Accepted	Folder renamed
265	SSUGRO SOILS_TX_[2006-07-06]: Please add metadata to all shapefiles and geodatabase contents. This must include a description of all fields.	Accepted	Database modified
266	Feature Dataset "xxx", Feature Class "xxx": please.		
267	Folder "xxx", File(s) "xxx": please.		
268	Per Article III, number 3, of the contract 1648302061: "one electronic copy of all the related documented source and derived data in the appropriate geodatabase(s)": please		
269	Per Exhibit B, Scope of Work, Task x, Subtask x.x, Scope deliverables, page x of 14: "cited text": please.		
270	Per Exhibit B, Scope of Work and Attachment 2, Section x.x.x, Data deliverables, page x of 4: "cited text": please.		
271	Boundary feature dataset: Please include shape file used to create Figure 4.2.1.	Accepted	Metadata modified
272	Appendix A Hydrographs, pages 1 through 79, All figures: reviewers unable to locate water level data for the appendix, please provide water level data used to develop all the hydrographs in Appendix A Hydrographs.	Accepted	waterlevel data added to deliverable folder
273	Feature Dataset "Boundary", Feature Class "County_clip": please provide the source of this data within the metadata.	Accepted	Metadata modified
274	Feature Dataset "Climate", Feature Class "LakeEvapQuads": please provide the source of this data within the metadata.	Accepted	Metadata added

275	Feature Dataset "Climate", Feature Class "Level_III_ecoregions_Texas": please move this feature class to the Conservation Feature Dataset.	Accepted	Feature class moved	
276	Feature Dataset "Climate", Feature Class "Physiographic_provinces_Texas": please move this feature class to the Conservation Feature Dataset. Additionally, the metadata appears to incorrectly describe state boundaries and a source from Bureau of Census – please correct with appropriate metadata.	Accepted	Feature class moved and metadata updated	
277	Feature Dataset "Climate", Feature Class "PRISM_Stations_30yrann": please provide the 30-year annual precipitation attribute field and include brief descriptions of all attribute fields and their units of measure for numeric data where applicable within the metadata.	Rejected		These are stations only, 30 year annual precip is contained the Recharge feature dataset in the DirectRecharge_PrismCells_Polygons feature class
278	Feature Dataset "Climate", Feature Class "Vegetation": please move this feature class to the Conservation Feature Dataset and include brief descriptions of all attribute fields within the metadata.	Accepted	Feature class moved and modified	
279	Feature Dataset "Climate": please provide the feature class for the climate classification map shown on Figure 2.1.4 of the study report and include brief descriptions of all attribute fields within the metadata.	Accepted	metadata changed	
280	Feature Dataset "Climate", Raster Catalog "ClimatePRISM": please provide within the metadata a table or brief descriptions of the raster dataset nomenclature within the raster catalog.	Accepted	metadata changed	
281	Feature Dataset "Conservation", Raster Catalog "ConservationLandUse": please provide National Land Cover Data (NLCD, 1992, 2001, 2011) raster data sets with appropriate metadata used for this study and shown on Figures 4.6.11, 4.6.12, and 4.6.13 of the study report.	Accepted	database modified	
282	Section 2, page 36, Figures 2.2.2: please provide a feature class within the Geology Feature Dataset used to create the lines of geologic section A to A', B to B', and C to C'.	Accepted	Feature class added	
283	Feature Dataset "Geology", Feature Class "Chittim_Anticline": please provide source of data within the metadata.	Accepted	Metadata modified	
284	Feature Dataset "Geology", Feature Class	Accepted	Metadata	

	“Devils_River_Uplift”: please provide source of data within the metadata.		modified	
	Feature Dataset “Geology”, Feature Class “Faults_Combined”: please include brief descriptions of attribute fields within the metadata including units of measure for numeric data where applicable. Also please provide attributed field for fault throw displacements of faults used in the framework conceptualization as discussed in teleconference meeting on January 8, 2018 and shown on Figure 4.1.2 on page 50 of the study report.	Rejected		Fault displacement gradients can be found in Hovorka et al. (1998) Figure 5.
285	Feature Dataset “Geology”, Feature Class “GAT_CONTACTS”: please provide attribute field for top of formation outcrop points and include brief descriptions of all attribute fields within the metadata including units of measure for numeric data where applicable.	Accepted	Metadata modified	
286	Feature Dataset “Geology”, Feature Class “Laramide_Front”: please provide source of data within the metadata.	Accepted	Metadata modified	
287	Feature Dataset “Geology”, Feature Class “Zavala_Syncline”: please provide source of data within the metadata.	Accepted	Metadata modified	
288	Feature Dataset “Geology”, Raster Catalog “GeologyGridsBottoms”: please provide metadata including brief descriptions of all attribute fields and their units of measure for numeric data where applicable within the metadata and a table or brief descriptions of the raster dataset nomenclature within the raster catalog.	Accepted	Metadata modified	
289	Feature Dataset “Geology”, Raster Catalog “GeologyGridsContinuousSurfaces”: please provide metadata including brief descriptions of all attribute fields and their units of measure for numeric data where applicable within the metadata and a table or brief descriptions of the raster dataset nomenclature within the raster catalog.	Accepted	Metadata modified	
290	Feature Dataset “Geology”, Raster Catalog “GeologyGridsIsopach”: please provide metadata including brief descriptions of all attribute fields and their units of measure for numeric data where applicable within the metadata and a table or brief descriptions of the raster dataset nomenclature within the raster catalog.	Accepted	Metadata modified	
291	Feature Dataset “Geology”, Raster Catalog “GeologyGridsIsopach”: please provide metadata including brief descriptions of all attribute fields and their units of measure for numeric data where applicable within the metadata and a table or brief descriptions of the raster dataset nomenclature within the raster catalog.	Accepted	Metadata modified	

292	Feature Dataset "Geology", Raster Catalog "GeologyGrids_Tops": please provide metadata including brief descriptions of all attribute fields and their units of measure for numeric data where applicable within the metadata and a table or brief descriptions of the raster dataset nomenclature within the raster catalog.	Accepted	Metadata modified	
293	Feature Dataset "Geology", Raster Catalog "GeologyMasks": please provide raster data sets with appropriate metadata or remove the raster catalog from the geodatabase if no hydraulic properties raster data sets were used or developed for this study.	Accepted	Metadata modified	
294	Feature Dataset "Geomorphology", Raster Catalog "GeomorphologyDEM": please provide units of vertical measure within the metadata.	Accepted	Metadata modified	
295	Feature Dataset "Geophysics", Feature Class "Well_Formation_Tops": please include brief descriptions of all attribute fields and their units of measure for numeric data where applicable within the metadata.	Accepted	Metadata modified	
296	Feature Dataset "Geophysics", Feature Class "Well_Logs_Hill Country Trinity": please include brief descriptions of all attribute fields and their units of measure for numeric data where applicable within the metadata. Please also include the attribute field or join table used to delineate hydrostratigraphic characterization well type (from literature vs. raster logs vs. interpreted LAS files) as shown in Figure 4.1.1 on page 49 of the study report.	Addressed		The LAS file interpretations are the same for the bracks project. Picks from literature should match the well groupings titled literature. All the other picks are from raster logs.
297	Feature Dataset "Recharge", Feature Class "DirectRecharge_PrismCells_Polygons": please include brief descriptions of all attribute fields within the metadata.	Accepted	Metadata modified	
298	Feature Dataset "Recharge", Feature Class "FocusedRecharge_StreamCells_Polygons": please include brief descriptions of all attribute fields within the metadata.	Accepted	Metadata modified	
299	Feature Dataset "Soil", Feature Class "SSURGO_STATSGO": reviewer was unable to reproduce map of soil drainage for Figure 2.1.12 on page 28 of the study report using "muaggatt" table provided within the "Hill Country Trinity Deliverable\SSUGRO SOILS_TX_[2006-07-06]" folder. Please provide join table or add an attribute field used to	Rejected		Directions for linking the SSURGO datasets are contained within the folder and are well documented.

	create the figure with data source and metadata including brief descriptions of all attribute fields and their units of measure for numeric data where applicable and/or description of categorical data types.			
300	Feature Dataset "SubSurfaceHydro", Feature Class "All_Aquifer_Test_Data_Points": please include brief descriptions of all attribute fields and their units of measure for numeric data where applicable within the metadata.	Accepted	Metadata modified	
301	Feature Dataset "SubSurfaceHydro", Feature Class "All_Specific_Capacity_Data_Points_w_CalcT_NoDups": please include data source and brief descriptions of all attribute fields and their units of measure for numeric data where applicable within the metadata.	Accepted	Metadata modified	
302	Feature Dataset "SubSurfaceHydro", Feature Class "AllTrin_Outcrop": please provide data source within the metadata.	Accepted	Metadata modified	
303	Feature Dataset "SubSurfaceHydro", Feature Class "Edw_1980_25_clip": please provide data source and metadata including brief descriptions of all attribute fields and their units of measure for numeric data where applicable within the metadata.	Accepted	Feature class removed	This has been removed since it was not used in the report
304	Feature Dataset "SubSurfaceHydro", Feature Class "Edw_1990_25_clip": please provide data source and metadata including brief descriptions of all attribute fields and their units of measure for numeric data where applicable within the metadata.	Accepted	Metadata modified	
305	Feature Dataset "SubSurfaceHydro", Feature Class "Edw_2000_25_clip": please provide data source and metadata including brief descriptions of all attribute fields and their units of measure for numeric data where applicable within the metadata.	Accepted	Metadata modified	
306	Feature Dataset "SubSurfaceHydro", Feature Class "Edw_2010_25_clip": please provide data source and metadata including brief descriptions of all attribute fields and their units of measure for numeric data where applicable within the metadata.	Accepted	Metadata modified	
307	Feature Dataset "SubSurfaceHydro", Feature Class	Accepted	Metadata	

	“EDW_Balcones Fault Zone_Hill Country Trinity_full2”: please provide data source within the metadata.		modified	
308	Feature Dataset “SubSurfaceHydro”, Feature Class “EDW_Outcrop”: please provide data source within the metadata.	Accepted	Metadata modified	
309	Feature Dataset “SubSurfaceHydro”, Feature Class “Edw_preD_25_clpClip”: please provide data source and metadata including brief descriptions of all attribute fields and their units of measure for numeric data where applicable within the metadata.	Accepted	Metadata modified	
310	Feature Dataset “SubSurfaceHydro”, Feature Class “EdwTrinPlat_Hill Country Trinity_full2”: please provide data source within the metadata.	Accepted	Metadata modified	
311	Feature Dataset “SubSurfaceHydro”, Feature Class “HydroAreas”: please provide the data for this empty feature class and include brief descriptions of all attribute fields and their units of measure for numeric data where applicable within the metadata or remove from the geodatabase if it was not used in the study.	Accepted	Metadata modified	Empty placeholder from the TWDB template geodatabase was deleted.
312	Feature Dataset “SubSurfaceHydro”, Feature Class “HydroContours”: please provide the data for this empty feature class and include brief descriptions of all attribute fields and their units of measure for numeric data where applicable within the metadata or remove from the geodatabase if it was not used in the study.	Accepted	Metadata modified	Empty placeholder from the TWDB template geodatabase was deleted.
313	Feature Dataset “SubSurfaceHydro”, Feature Class “LoTrin_1980_25_clpClip_North”: please provide data source and metadata including brief descriptions of all attribute fields and their units of measure for numeric data where applicable within the metadata.	Accepted	Database modified	This has been removed since it was not used in the report.
314	Feature Dataset “SubSurfaceHydro”, Feature Class “LoTrin_1990_25_clpClip_North”: please provide data source and metadata including brief descriptions of all attribute fields and their units of measure for numeric data where applicable within the metadata.	Accepted	Database modified	This has been removed and replaced with “LoTrin_1990_25_clpClip.” The replacement feature class and metadata has been added to the geodatabase.
315	Feature Dataset “SubSurfaceHydro”, Feature Class “LoTrin_2000_25_clpClip_North”: please provide data source	Accepted	Database modified	This has been removed and replaced with “LoTrin_2000_25_clpClip.” The replacement

	and metadata including brief descriptions of all attribute fields and their units of measure for numeric data where applicable within the metadata.			feature class and metadata has been added to the geodatabase.
316	Feature Dataset "SubSurfaceHydro", Feature Class "LoTrin_2000_25_clpCip_South": please provide data source and metadata including brief descriptions of all attribute fields and their units of measure for numeric data where applicable within the metadata.	Accepted	Database modified	This has been removed and replaced with "LoTrin_2000_25_clpCip." The replacement feature class and metadata has been added to the geodatabase.
317	Feature Dataset "SubSurfaceHydro", Feature Class "LoTrin_2010_25_clpCip_North": please provide data source and metadata including brief descriptions of all attribute fields and their units of measure for numeric data where applicable within the metadata.	Accepted	Database modified	This has been removed and replaced with "LoTrin_2010_25_clpCip." The replacement feature class and metadata has been added to the geodatabase.
318	Feature Dataset "SubSurfaceHydro", Feature Class "LoTrin_2010_25_clpCip_South": please provide data source and metadata including brief descriptions of all attribute fields and their units of measure for numeric data where applicable within the metadata.	Accepted	Database modified	This has been removed and replaced with "LoTrin_2010_25_clpCip." The replacement feature class and metadata has been added to the geodatabase.
319	Feature Dataset "SubSurfaceHydro", Feature Class "LoTrin_pred_25_clpCip_North": please provide data source and metadata including brief descriptions of all attribute fields and their units of measure for numeric data where applicable within the metadata.	Accepted	Database modified	This has been removed and replaced with "LoTrin_pred_25_clpCip." The replacement feature class and metadata has been added to the geodatabase.
320	Feature Dataset "SubSurfaceHydro", Feature Class "MasterWells_v4": please provide data source and metadata including brief descriptions of all attribute fields and their units of measure for numeric data where applicable within the metadata.	Accepted	Metadata modified	
321	Feature Dataset "SubSurfaceHydro", Feature Class "MasterWells_v4_WLs": please provide data source and metadata including brief descriptions of all attribute fields and their units of measure for numeric data where applicable within the metadata.	Accepted	Metadata modified	
322	Feature Dataset "SubSurfaceHydro", Feature Class "MidTrin_1980_25_clpCip_North": please provide metadata including brief descriptions of all attribute fields and their units of measure for numeric data where applicable within the metadata.	Accepted	Database modified	This has been removed since it was not used in the report.

323	Feature Dataset "SubSurfaceHydro", Feature Class "MidTrin_1990_25_clpClp_North": please provide data source and metadata including brief descriptions of all attribute fields and their units of measure for numeric data where applicable within the metadata.	Accepted	Database modified	This has been removed and replaced with "MidTrin_1990_25_clpClp." The replacement feature class and metadata has been added to the geodatabase.
324	Feature Dataset "SubSurfaceHydro", Feature Class "MidTrin_2000_25_clpClp_North": please provide data source and metadata including brief descriptions of all attribute fields and their units of measure for numeric data where applicable within the metadata.	Accepted	Database modified	This has been removed and replaced with "MidTrin_2000_25_clpClp." The replacement feature class and metadata has been added to the geodatabase.
325	Feature Dataset "SubSurfaceHydro", Feature Class "MidTrin_2000_25_clpClp_Souths": please provide data source and metadata including brief descriptions of all attribute fields and their units of measure for numeric data where applicable within the metadata.	Accepted	Database modified	This has been removed and replaced with "MidTrin_2000_25_clpClp." The replacement feature class and metadata has been added to the geodatabase.
326	Feature Dataset "SubSurfaceHydro", Feature Class "MidTrin_2010_25_clpClp_North": please provide data source and metadata including brief descriptions of all attribute fields and their units of measure for numeric data where applicable within the metadata.	Accepted	Database modified	This has been removed and replaced with "MidTrin_2010_25_clpClp." The replacement feature class and metadata has been added to the geodatabase.
327	Feature Dataset "SubSurfaceHydro", Feature Class "MidTrin_2010_25_clpClp_South": please provide data source and metadata including brief descriptions of all attribute fields and their units of measure for numeric data where applicable within the metadata.	Accepted	Metadata modified	This has been removed and replaced with "MidTrin_2010_25_clpClp." The replacement feature class and metadata has been added to the geodatabase.
328	Feature Dataset "SubSurfaceHydro", Feature Class "MidTrin_preD_25_clpClp_North": please provide data source and metadata including brief descriptions of all attribute fields and their units of measure for numeric data where applicable within the metadata.	Accepted	Metadata modified	This has been removed and replaced with "MidTrin_preD_25_clpClp." The replacement feature class and metadata has been added to the geodatabase.
329	Feature Dataset "SubSurfaceHydro", Feature Class "StateGrid_SpJoin_TNRCCvals_from_ReceivedShp_051118": please include brief descriptions of all attribute fields and their units of measure for numeric data where applicable within the metadata.	Accepted	Metadata modified	
330	Feature Dataset "SubSurfaceHydro", Feature Class "TDS_Edwards": please include data source and brief descriptions of all attribute fields and their units of measure for	Accepted	Metadata modified	

	numeric data where applicable within the metadata.			
331	Feature Dataset "SubSurfaceHydro", Feature Class "TDS_Lower_Trinity": please include data source and brief descriptions of all attribute fields and their units of measure for numeric data where applicable within the metadata.	Accepted	Metadata modified	
332	Feature Dataset "SubSurfaceHydro", Feature Class "TDS_Middle_Trinity": please include data source and brief descriptions of all attribute fields and their units of measure for numeric data where applicable within the metadata.	Accepted	Metadata modified	
333	Feature Dataset "SubSurfaceHydro", Feature Class "TDS_Time_History_Wells": please include data source and brief descriptions of all attribute fields and their units of measure for numeric data where applicable within the metadata.	Accepted	Metadata modified	
334	Feature Dataset "SubSurfaceHydro", Feature Class "TDS_Upper_Trinity": please include data source and brief descriptions of all attribute fields and their units of measure for numeric data where applicable within the metadata.	Accepted	Metadata modified	
335	Feature Dataset "SubSurfaceHydro", Feature Class "UpTrin_2000_25_clpCip_North": please provide data source and metadata including brief descriptions of all attribute fields and their units of measure for numeric data where applicable within the metadata.	Accepted	Database modified	This has been removed and replaced with "UpTrin_2000_25_clpCip." The replacement feature class and metadata has been added to the geodatabase.
336	Feature Dataset "SubSurfaceHydro", Feature Class "UpTrin_2000_25_clpCip_South": please provide data source and metadata including brief descriptions of all attribute fields and their units of measure for numeric data where applicable within the metadata.	Accepted	Database modified	This has been removed and replaced with "UpTrin_2000_25_clpCip." The replacement feature class and metadata has been added to the geodatabase.
337	Feature Dataset "SubSurfaceHydro", Feature Class "UpTrin_2010_25_clpCip_North": please provide data source and metadata including brief descriptions of all attribute fields and their units of measure for numeric data where applicable within the metadata.	Accepted	Database modified	This has been removed and replaced with "UpTrin_2010_25_clpCip." The replacement feature class and metadata has been added to the geodatabase.
338	Feature Dataset "SubSurfaceHydro", Feature Class "UpTrin_2010_25_clpCip_South": please provide data source and metadata including brief descriptions of all attribute fields and their units of measure for numeric data where applicable	Accepted	Database modified	This has been removed and replaced with "UpTrin_2010_25_clpCip." The replacement feature class and metadata has been added to the geodatabase.

	within the metadata.				
339	Feature Dataset "SubSurfaceHydro", Feature Class "UpTrin_preD_25_clip_North": please provide data source and metadata including brief descriptions of all attribute fields and their units of measure for numeric data where applicable within the metadata.	Accepted	Database modified	This has been removed and replaced with "UpTrin_preD_25_clipClip." The replacement feature class and metadata has been added to the geodatabase.	
340	Feature Dataset "SubSurfaceHydro", Feature Class "UpTrin_preD_25_clipClip_South": please provide data source and metadata including brief descriptions of all attribute fields and their units of measure for numeric data where applicable within the metadata.	Accepted	Database modified	This has been removed and replaced with "UpTrin_preD_25_clipClip." The replacement feature class and metadata has been added to the geodatabase.	
341	Feature Dataset "SubSurfaceHydro", Feature Class "WaterQualityValues": please include brief descriptions of all attribute fields and their units of measure for numeric data where applicable within the metadata.	Accepted	Metadata modified		
342	Feature Dataset "SubSurfaceHydro", Feature Class "wells_w_WLControlPoints": please provide data source and metadata including brief descriptions of all attribute fields and their units of measure for numeric data where applicable within the metadata.	Accepted	Metadata modified		
343	Feature Dataset "SubSurfaceHydro", Raster Catalog "SubSurfaceHydroHydraulics": please provide raster data sets with appropriate metadata or remove the raster catalog from the geodatabase if no hydraulic properties raster data sets were used or developed for this study.	Accepted	Raster catalog removed		
344	Feature Dataset "SubSurfaceHydro", Raster Catalog "SubSurfaceHydroWaterLevels": please provide raster data sets with appropriate metadata used or developed to create the contour water level maps for section 4.2 of the study report.	Accepted	Rasters added	The rasters used to develop the water level contours have been added to the geodatabase.	
345	Feature Dataset "SurfaceHydro", Feature Class "EDW_DEM_streams_pts_GAM": please provide data source and metadata including brief descriptions of all attribute fields and their units of measure for numeric data where applicable within the metadata.	Accepted	Metadata modified		
346	Feature Dataset "SurfaceHydro", Feature Class "EDW_Springs": please provide data source and metadata	Accepted	Metadata modified		

	including brief descriptions of all attribute fields and their units of measure for numeric data where applicable within the metadata.			
347	Feature Dataset "SurfaceHydro", Feature Class "EPA_RF1_RiverReach": please provide brief descriptions of all attribute fields and their units of measure for numeric data where applicable within the metadata.	Accepted	Database modified	
348	Feature Dataset "SurfaceHydro", Feature Class "GainLossData": please provide brief descriptions of all attribute fields and their units of measure for numeric data where applicable within the metadata.	Accepted	Database modified	
349	Feature Dataset "SurfaceHydro", Feature Class "GainLossDataSynopticMGaryEAA": please provide brief descriptions of all attribute fields and their units of measure for numeric data where applicable within the metadata.	Accepted	Database modified	
350	Feature Dataset "SurfaceHydro", Feature Class "LoTrin_DEM_streams_pts_GAM": please provide data source and metadata including brief descriptions of all attribute fields and their units of measure for numeric data where applicable within the metadata.	Accepted	Database modified	
351	Feature Dataset "SurfaceHydro", Feature Class "LoTrin_Springs": please provide data source and metadata including brief descriptions of all attribute fields and their units of measure for numeric data where applicable within the metadata.	Accepted	Database modified	
352	Feature Dataset "SurfaceHydro", Feature Class "MajorStreamsRiversTCEQ": please provide metadata including brief descriptions of all attribute fields.	Accepted	Database modified	
353	Feature Dataset "SurfaceHydro", Feature Class "MidTrin_DEM_streams_pts_GAM": please provide data source and metadata including brief descriptions of all attribute fields and their units of measure for numeric data where applicable within the metadata.	Accepted	Database modified	
354	Feature Dataset "SurfaceHydro", Feature Class "MidTrin_Springs": please provide data source and metadata including brief descriptions of all attribute fields and their units of measure for numeric data where applicable within the	Accepted	Database modified	

	metadata.			
355	Feature Dataset "SurfaceHydro", Feature Class "NHD_Lines": please provide join table or attribute fields for "Feature Type", "Feature Code", and metadata including brief descriptions of all attribute fields and their units of measure for numeric data where applicable within the metadata.	Accepted	Database modified	
356	Feature Dataset "SurfaceHydro", Feature Class "Springs": please provide missing feature class data and metadata including brief descriptions of all attribute fields and their units of measure for numeric data where applicable within the metadata.	Accepted	Feature class removed	
357	Feature Dataset "SurfaceHydro", Feature Class "StreamGage": please provide missing data for attribute fields for properties and metadata including data source and brief descriptions of all attribute fields and their units of measure for numeric data where applicable within the metadata.	Accepted	Database modified	
358	Feature Dataset "SurfaceHydro", Feature Class "StreamReach": please provide missing feature class data and metadata including data source and brief descriptions of all attribute fields and their units of measure for numeric data where applicable within the metadata.	Accepted	Feature class removed	
359	Feature Dataset "SurfaceHydro", Feature Class "TX_Reservoirs": please provide data source and metadata including brief descriptions of all attribute fields and their units of measure for numeric data where applicable within the metadata.	Accepted	Metadata fixed	
360	Feature Dataset "SurfaceHydro", Feature Class "UpTrin_DEM_streams_pts_GAM": please provide data source and metadata including brief descriptions of all attribute fields and their units of measure for numeric data where applicable within the metadata.	Accepted	Database modified	
361	Feature Dataset "SurfaceHydro", Feature Class "UpTrin_Springs": please provide data source and metadata including brief descriptions of all attribute fields and their units of measure for numeric data where applicable within the metadata.	Accepted	Database modified	

362	Table "SUBHYD_BaseFlowFractions": please provide metadata including brief descriptions of all attribute fields and their units of measure for numeric data where applicable within the metadata.	Accepted	Database modified
363	Table "SUBHYD_Water_Quality": please provide metadata including brief descriptions of all attribute fields and their units of measure for numeric data where applicable within the metadata.	Accepted	Database modified
364	Table "SURHYD_GainLoss_Frates12015": please provide metadata including brief descriptions of all attribute fields and their units of measure for numeric data where applicable within the metadata.	Accepted	Database modified
365	Table "SURHYD_GainLossMGaryEAA": please provide metadata including brief descriptions of all attribute fields and their units of measure for numeric data where applicable within the metadata.	Accepted	Database modified
366	Table "SURHYD_LakeElevation": please provide metadata including brief descriptions of all attribute fields and their units of measure for numeric data where applicable within the metadata.	Accepted	Database modified
367	Table "SURHYD_StreamFlow": please provide metadata including brief descriptions of all attribute fields and their units of measure for numeric data where applicable within the metadata.	Accepted	Database modified
368	Folder "Hill Country Trinity Deliverable": please provide the water level data used to create the figures in AppendixA_Hydrographs.pdf with appropriate metadata.	Accepted	Water level data added to deliverable folder
369	Folder "Hill Country Trinity Deliverable": please provide appropriate metadata with units of measure for each numeric field for the Excel file EAA_Gain_loss_synoptic_data_Hill Country Trinity.xlsx.	Accepted	Database modified
370	Folder "Hill Country Trinity Deliverable\Baseflow": please provide a metadata or readme file describing the different files in this folder and contents – for example: there are two excel files with baseflow separation results and reviewer was unable to determine their difference.	Accepted	Readme file added

371	Folder "Hill Country Trinity Deliverable\Baseflow", File(s) "Hill Country TrinityStreamBaseFlowProcessed.xlsm": please repair the macro – unable to evaluate this file.	Accepted	macro fixed and tested	
372	Folder "Hill Country Trinity Deliverable\Logs\Formation_Picks.xls": please include the GAM X and Y coordinates for these data.	Accepted	Added GAM Coordinates	
373	Folder "Hill Country Trinity Deliverable\Logs\Well_Data_wFileNames.xls": please include the GAM X and Y coordinates for these data and/or consider merging these data with "Hill Country Trinity Deliverable\Logs\Formation_Picks.xls".	Accepted	Added GAM Coordinates	
374	Folder "Hill Country Trinity Deliverable\Logs": unable to locate geophysical logs from Texas Commission for Environmental Quality, Railroad Commission, or Bureau of Economic Geology as described in Exhibit B, Scope of Work, Task 4, Scope deliverables, page 3 of 14. Please provide a list or lookup table to determine which geophysical logs were sourced from Texas Commission for Environmental Quality, Railroad Commission, or Bureau of Economic Geology.	Addressed		All logs used have been provided. Log sources are noted where possible.
375	Folder "Hill Country Trinity Deliverable\Precip_PRISM_data", File(s) "Compiled +Graphs.xlsx": please include station metadata such as station name and location coordinates.	Accepted		Metadata file added to Precip_PRISM_data in deliverable folder
376	Folder "Hill Country Trinity Deliverable\ Representative Lithology: please provide a metadata or readme file describing the different files in this folder and contents.	Accepted	Readme file added	
377	Per Exhibit B, Attachment 1: Please update all references to Barton Springs/Edwards Aquifer Conservation District to include the "/".	Accepted	Text modified	
378	Figures 2.1.8 and 2.1.9: please consider using the precipitation names rather than county names.	Rejected		Reader can look up station more easily using number.
379	Figures 4.1.8 through 4.1.24: Please consider adding control point locations to get an idea control density used in developing the surfaces.	Rejected		Infeasible to edit so many figures.
380	Please rename the geodatabase as appropriate.	Accepted	Geodatabase renamed	
381	Please consider merging Hill Country Trinity Deliverable\Logs\Well_data_wFileNames.xls file with Hill	Rejected		This would result in duplicate data.

	Country Trinity Deliverable\Logs\Formation_Picks.xls.			
382	Section 1.0: Please include additional background on how and why this effort was initiated.	Accepted		Introduction recast to highlight motivation of the project
383	Section 1.0: Please add acknowledgement that the TWDB periodically solicits feedback on the Groundwater Availability Modeling projects from the public.	Accepted	Text modified	
384	Section 1.0: Please include some background on the Hill Country Trinity, the need for conceptual and numerical models, and water availability issues such as its designation as a Priority Groundwater Management Area (PGMA).	Accepted	Text modified	
385	Figure 2.0.1: Please show the previous groundwater availability model boundary for reference.	Accepted	Figure modified	
386	Section 2.1: Please include discussion, tables, and charts describing climatic averages or ranges. Data should include evapotranspiration, temperature, rainfall, etc.	Addressed		Sufficient figures and discussion on climate are included
387	Section 2.1: Please include charts of hydrologic data and any trends observed in temperature, rainfall, streamflow, and springflow.	Rejected		Trends in climate is beyond the scope of project
388	Section 2.2.3: There is mention of the Trinity Group as Early to Middle Cretaceous. These rocks are Early Cretaceous and there is no Middle Cretaceous in stratigraphic nomenclature. Please revise the text to reflect this.	Rejected		Middle Cretaceous is a subjective term
389	Section 2.2.4: The maps in the document (Figure 2.2.4) reflect regional structures such as Llano Uplift, San Marcos Arch, Ouachita Front, and Laramide Front. Please add a brief description of these structural elements, upon which the Balcones Fault Zone was developed.	Addressed		Significant discussion and description included on structural elements of the HCT domain
390	Section 2.2.4: When discussing the cause of the Balcones Fault Zone and the relative motion, Rose (2016) does not attribute its formation solely to subsidence into the Gulf of Mexico. Rather his contention is that the Plateau was uplifted. Please mention this as a potential mechanism with a citation.	Accepted	Text modified	
391	Section 2.2.4: The relay ramps are an important structure that is not specifically mentioned in this section. These are very important structures at all scales and have implications for	Accepted	Text modified	

	descriptions of groundwater flow in future sections. Please revise the text to discuss relay ramps.			
392	Section 2.2.4: Please cite Grimshaw and Woodruff (1986); Collins (1995); Collins (2004); Collins and Hovorka (1997) in the discussion of en echelon faults.	Accepted	Text modified	
393	Section 2.2.4: Please add discussion about karst development in the Upper Glen Rose, Lower Glen Rose, and Cow Creek Limestone.	Addressed		Additional reference to karst incorporated
394	Section 3.0: Please add discussion of intra-formational flow of the Trinity Aquifer from the Hill Country into the Balcones Fault Zone portions of the aquifer.	Addressed		Interformational flow is discussed elsewhere, including Section 5
395	Section 4.0: Please add discussion of the influence that the karst development has on hydrology.	Addressed		References to karst added.
396	Section 4.1: The third paragraph describes the Trinity Aquifer as occurring west of the Balcones Fault Zone, and not the portion beneath the Edwards (Balcones Fault Zone) Aquifer. Please revise this statement to indicate that the Trinity Aquifer extends beneath the Edwards (Balcones Fault Zone) Aquifer.	Accepted	Text modified	
397	Section 4.1.2: Please clarify in the discussion which fault model was selected for use in the study. Figure 4.1.2 indicates faults modeled in this study, but those faults appear incomplete as the Mt. Bonnell and Tom Creek Faults in Hays and Travis are not included. The Fratesi et al. (2015) model appears to be the more complete but is not clear if it was used as the final fault model.	Accepted	Text modified	
398	Section 4.1.2: In the last paragraph of this section, please add some discussion of relay ramps and how that may affect the lateral continuity of hydrostratigraphic units.	Accepted	Text modified	
399	Figure 4.1.15: This figure shows that the Hensell thickens from NW to SE. This is opposite of what the data indicate. The Hensell is thickest in the NW (~70 ft) and thins to the SE (~30 ft) (Wierman et al., 2010). Please revise or explain differences from other studies.	Addressed		The data Figure 6.1 in Wierman et al are variable with thickness of 60 ft in the south. It is a challenge to identify a clear thickness trend in the Hensell data. The regional isopach map (Figure 4.1.16) has a large contour interval to small the noisy data.
400	Figure 4.1.16: The Cow Creek isopach map does not appear to match the data (Wierman et al., 2010). Please revise or explain differences from other studies.	Addressed		Figure 5.3 in Wierman et al could be recontoured showing a high NW-SE ridge through the middle of Hayes County. Actual

				differences in data are not significant.
401	Section 4.2.3: The approach of compartmentalizing water-level data in two separate domains of the Hill Country Trinity and Balcones Fault Zone can provide erroneous interpretations of the data. However, an additional approach of contouring the data as one single domain is also warranted. Compartmentalizing the data artificially segments the potentiometric surface (such as Figure 4.2.1.9). With a single domain the data itself can highlight areas of compartmentalization. Please add a brief discussion of the advantages and disadvantages of the two methodologies.	Accepted		The water level contours have been revised so that they are no longer artificially compartmentalized. This approach may misleadingly smooth over some of the large structural offsets present in the Balcones Fault Zone. However, if there is sufficient well data to support the existence of an offset, this should show up in the contours without having to force an artificial compartmentalization through the contouring methodology.
402	Section 4.3: Please include a brief review of published recharge, runoff, and evapotranspiration studies in the Hill Country Trinity Aquifer. These include Banta and Slattery (2011); Slattery et al. (2006); and Dugas et al. (1998).	Accepted	Text modified	
403	Section 4.3: Please add a comparison of the results of the recharge estimates to the existing literature in a simple table. Please consider using the average and range of values as a percent of annual precipitation, which is commonly cited.	Rejected		A table would be simple. The analyses are not. Hill Country recharge is an open debate. Hopefully calibration of the numerical model will help resolve this contentious issue.
404	Section 4.3: Please add discussion of the karstic processes related to recharge.	Accepted	Text modified	
405	Figure 4.4.5: Please indicate whether the values in this figure are absolute flow values or gain-loss values and please include what units are used.	Accepted	Figure modified	
406	Section 4.5: Please include a summary table and figure that includes the range of measured or estimated hydraulic property values along with values from the literature and previous GAM studies.	Accepted	Figures and tables added	Summary tables (4.5.3, 4.5.5, and 4.5.6) and figures (4.5.13 and 4.5.15) have been added and additional text has been inserted into Sections 4.5.2 and 4.5.5 to describe the data in the new tables/figures and compare them to the calculated values.
407	Section 4.6.1: Please add spring discharge data from major springs in the study area.	Addressed		Citations added which discuss spring discharge
408	Section 4.6.2: Please clarify if the pumping data includes pumping data compiled by local groundwater conservation districts for 2008 that is contained within the most recent GMA 9 Explanatory Report (GMA 9, 2016).	Accepted	Additional text added	This data was considered and compared to the calculated pumping values but was not directly used to create the historical time series. Additional text has been inserted into Sections 4.6.2.1.3 and 4.6.2.4 and an additional table

(Table 4.6.5) has been added for clarification.

Response 235A: A significant number of the cited wells are located in the western portion of Hays County. These include the following wells: 55464; 55465; 55467; 55484; 55522; 55525; 55623; 55626; 55656; 55662; 55575; 55589; 55590; 55593; 55597; 55570; 55601; 55623; 55626; 55628. Picks from these wells were compared with the structure maps from Wierman and others (2010). Of particular relevance are the structure maps for the lower Trinity (Figure 4-2), Hammett (Figure 5-2), Cow Creek (Figure 5-4), Hensel (Figure 6-2), and the lower Glen Rose (Figure 6-4). As clearly illustrated in each of these structure maps, this area is beset with considerable faulting. Offset attribute to faults in western Hayes County is illustrated in structural cross-section transects D-D' (Figure 10-2) and E-E' (Figure 11-2) of Wierman and others (2010). The complexity of the logs used to prepare the surfaces and cross sections is clearly indicated in stratigraphic cross-section transects D-D' (Figure 10-1) and E-E' (Figure 11-1) of Wierman and others (2010). The project team does not dispute the stratigraphic picks and ensuing interpretations by Wierman and others (2010). It needs to be recognized that determination of formation picks from imperfect data (i.e., wells of limited or poor quality, projecting literature data, etc.) relies on professional judgement. Critical to the project final documentation, variations between the project team's formation picks and formation picks of others have been determined to not materially change either the formation surfaces or the conceptual interpretation of the hydrogeology of the study area. These variations in formation pick designations are reflective of differences of geological interpretation and are not indicative of a study wide problem with the stratigraphic correlations.

Response 235B: Wells in eastern Kendall County (Holy Archangels Greek Orthodox Monastery, 5759901_check, Check Ranch 1, 34394, 37806, 42769, 83023, 83033, and 83030), northeast Bexar County (Rogers Ranch 1, Adam C A WI-3, Talley James Hady 1, AY-68-27-5, Ellison 1, Ewert 1, Theis Adolf 1, AY-68-27-1, 16766, 48666, 53148, 53149, 53272, and 53273), central and south Comal County (R W Anderson #1, Rebecca Creek Ranch 1, Gailowell3, 11010 HWY 46, 33501, and 37800) are outside of the study area of Wierman and others (2010) and cannot be compared with the results of this study. There are limited well data available for this area. Similar to Comment 235A, it needs to be recognized that determination of formation picks from imperfect data (i.e., wells of limited or poor quality, projecting literature data, etc.) relies on professional judgement. Critical to the project final documentation, variations between the project team's formation picks and formation picks of others have been determined to not materially change either the formation surfaces or the conceptual interpretation of the hydrogeology of the study area. These variations in formation pick designations are reflective of differences of geological interpretation and are not indicative of a study wide problem with the stratigraphic correlations.

Response 235C: Similar to Comment 235A, the well in eastern Hayes County (43757) is located in an area with considerable geologic faulting [lower Trinity (Figure 4-2), Hammett (Figure 5-2), Cow Creek (Figure 5-4), Hensel (Figure 6-2), and the lower Glen Rose (Figure 6-4) of Wierman and others (2010)] and offset structural cross-section transects A-A' (Figure 7-2) of Wierman and others (2010).

Response 235D: Please note that picks were made by projecting surfaces through borehole location.

Technical Review and Comments: Conceptual Model Update for the Hill Country Portion of the Trinity Aquifer

August 31, 2018

Brian B. Hunt and Brian A. Smith
Barton Springs/Edwards Aquifer Conservation District

Marcus O. Gary
Edwards Aquifer Authority

Jeff Watson and Alex S. Broun
Hays Trinity Groundwater Conservation District

Douglas A. Wierman
Texas State University-Meadows Center

Ron Fieseler
Blanco Pedernales Groundwater Conservation District

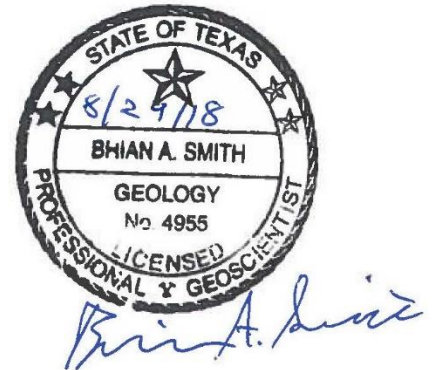
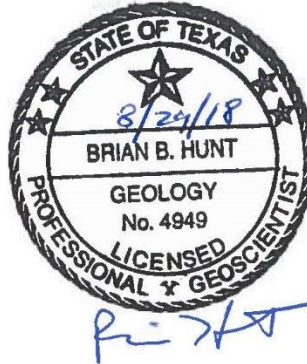

Preface

This document was prepared in response to a request for comments on the draft report: Conceptual Model Update for the Hill Country Portion of the Trinity Aquifer, dated May 31, 2018 (TWDB Contract No. 1648302061). The authors of these comments have been working cooperatively on the hydrogeology and groundwater availability of the Trinity Aquifers in the Blanco, Hays, and Travis Counties for more than 10 years. We offer these comments to enhance and improve the report, which we hope will result in the best numerical model possible.

Our technical review indicates there are significant gaps in the report that should be addressed. To assist with that effort, we have provided relatively detailed comments and citations. Some of our comments relate to the scale of the study area versus the smaller geographic area with more detail in which the authors work. Regardless of scale differences we believe it is critical for a conceptual model report to be comprehensive, detailed, and current such that it will expand the hydrogeologic knowledge of the region. This report should be a key reference and data source for the numerical model and future investigations into the Trinity.

We understand these comments are being submitted following a review of the final draft report at the end of the study, which makes efforts to address these gaps challenging. A technical review meeting in the middle of the project was lacking as part of the study, In fact, such a request was made by the authors at the June 5, 2017 kickoff meeting at SWRI for this study. A mid-point review would have ensured an efficient and meaningful process for recent lithostratigraphic, structural, geochemical, and hydrogeologic interpretations to be fully evaluated and incorporated into the report. The risk of the report as it stands now is that the primary users, such as groundwater districts, end up with a groundwater availability model that they cannot technically support or that has little application to district groundwater availability issues.

While we think the gaps are substantial in the report, we know they can be addressed. At the very least, these technical comments should be included in the appendix of the report. Please let us know if we can provide any additional clarity or data based on these comments.

Specific Comments

1.0 Introduction

The intent of the introduction of the report is to give some background on how and why this effort was initiated. Some additional background on this process could be added, such as:

- Acknowledge that the TWDB periodically solicits feedback on the Groundwater Availability Modeling projects from the public.
- At one such meeting in July 2014, BSEACD staff verbally, and with a letter (dated 7/22/2014), recommended a future TWDB modeling task be a revised Hill Country Trinity GAM. Among other recommendations was that the model should extend to the east from the existing boundary reflecting our current understanding about the lateral continuity of the aquifers from the Hill Country into the Balcones Fault Zone. Clearly TWDB staff supported the recommendation, but this points to the fact that there was support and demand from the local GCDs for this project.
- Discuss some background on the Hill Country Trinity and the need for conceptual and numerical models. There is no mention of water availability issues such as it's designation as a Priority Groundwater Management Area (PGMA).

2.0 Study Area

Figure 2.0.0.11 consider showing the previous GAM boundary for reference, and even the resulting conceptual model boundary.

- Consider adding a simple summary table of area statistics that might help summarize the associated maps in reference to those three boundaries. For example: square miles of the current study area vs the previous GAM, vs conceptual model. Other statistics could include square miles and percent of various aquifers in relation to those boundaries.

2.1 Physiography and Climate

There is almost no information related to the state of climate change, characterization of droughts, floods and hydrologic trends. This is a significant gap in the conceptual model. This information provides important context for the later sections in the report and future numerical model calibration and climatic scenarios.

- Provide discussion, tables, and charts describing climatic averages or ranges. Data should include evapotranspiration, temperature, rainfall, etc.
- Provide charts of hydrologic data and any trends observed in temperature, rainfall, streamflow, and springflow, which are important for future calibration and scenarios (Hunt et al., 2012).
 - Climatic shifts influence springflow and streamflow rates. Hunt et al., 2012 document rising trends in temperature and rainfall, increased variability of flow, increased average flows, but decreases in baseflows and low springflows over the last 20 years. An evaluation should include USGS gages at the Blanco River at Wimberley, the Guadalupe River at Comfort, the Frio River at Concan, and the Nueces River at Laguna.

- Provide a section describing the frequency and duration of droughts in the study area, and perhaps focusing on the data from the 1950s drought compared to more recent droughts. This is very important for establishing water budgets for the aquifers during droughts. This could include summary tables of rainfall, river, and springflow amounts during the DOR and other droughts. A comparison of the DOR to the more recent 2009 and 2011 droughts would be valuable. For example, see Smith and Hunt (2010).
 - Streamflows are a proxy for springflows in the Hill Country in many locations. The baseflows at the Blanco River at Wimberley was made up of 75% from Pleasant Valley Spring, and 25% from Jacob’s Well Spring based on USGS measurements from the 1950s (TWDB, 1960). Recent analysis of the period of record of Jacob’s Well Spring indicates the spring now only accounts for approximately 8% of the flow in the Blanco as measured at Wimberley and decreases to 0% under extreme drought.
- Fast-responding aquifers, such as karst aquifers, are very susceptible to climate change (Mace and Wade, 2008). Portions of the Middle Trinity may respond to recharge quickly, while other areas may not.

2.2 Geology

- The recent geology book by Ewing (2016) is a comprehensive source of information. This would be a good citation to include where appropriate.
- The narrative should not confuse the geologic units with the aquifers as defined in the literature. Pg. 29 (6th line): “These aquifers are composed of geologic units that include the Glen Rose, Cow Creek...”

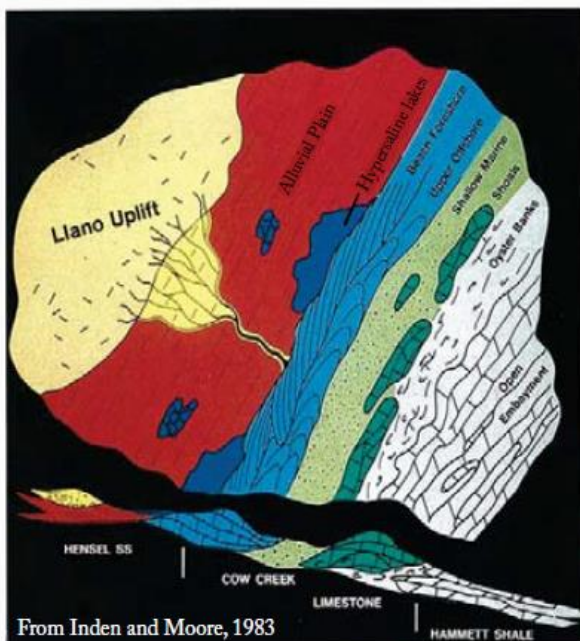

Figure 1. Depositional environments include terrestrial to marine settings, which resulted in diverse lithologic units. The units are essentially time-equivalent strata as shown in this figure.

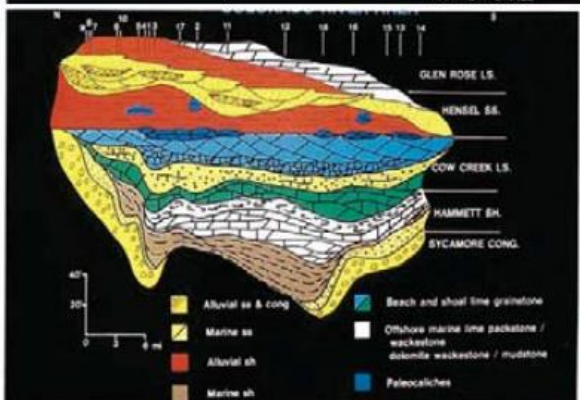

Figure 2. Generalized stratigraphic cross section from the Hill Country showing the lithostratigraphic units and their corresponding geometry.

2.2.3 Stratigraphy/Lithology

The description and importance of the geologic formations of the Trinity Group to groundwater availability could be expanded and improved. Additional subsurface and surface work has refined our geologic characterization of the various units (Wierman et al., 2010).

- More discussion of the stratigraphic evolution of the carbonate platform is needed (Phelps et al., 2014, 2015; Rose, 2016a).
- Schematic maps could be included as small figures from the literature such as Inden and More (1983).
- Review stratigraphic nomenclature. There is mention of the Trinity Group as Early to Middle Cretaceous. These rocks are Early Cretaceous., and there is no Middle Cretaceous in stratigraphic nomenclature.

The lithostratigraphic descriptions provided below could be integrated to enhance the descriptions in the report. In addition, more discussion of the depositional environments in context of the depositional domains identified would be a good addition.

From Inden and Moore, 1983

Paleozoic-Hosston Contact

- While this contact may be extremely varied across the study area, some mention could be provided: “The Lower Cretaceous, Hosston formation was deposited directly on an eroded, truncated and peneplained Paleozoic surface. To the west, near the Llano Uplift, Ellenburger carbonates subcrop beneath the Hosston. Further eastward, rocks of Marble Falls Limestone and Smithwick Shale are encountered. The contact in Hays County is represented on the gamma curve as a sharp break, and often shows a pronounced positive gamma response. This may represent a basal arkosic conglomerate that forms part of a reworked, rubble surface derived from Precambrian granites.” (Wierman et al., 2010)

Hosston & Sligo

- There are thick conglomerates in the Hosston that produce water in both Blanco and Hays Counties. Porosity in the Hosston sands are occluded by clay in the west, but may clean up to the east (Al Broun, personal communication).
- The Hosston is the updip (exposed) equivalent of the Sycamore Sand, which is not the way it is described in the report. The Hosston and the Sycamore depositional settings are fluvial-lagoonal in nature, and also have conglomerate facies, particularly in the updip areas, that are not mentioned, but are important facies for groundwater availability (Wierman et al., 2010).
- The Sligo in Hays County contains an upper “oolitic skeletal limestone with a micritic matrix. Underlying the tight limestone is a porous dolomite that is water bearing in several local wells. Northwest of the Sligo pinchout, the Hammett overlies the Hosston/Sycamore.” (Wierman et al., 2010)
- Sligo is lumped into “Lower Trinity” on the right side of Figure 2.2.1 when most other lithostratigraphic units are delineated. I believe the intent would be to identify it as a potential hydrostratigraphic unit.
- The Sligo can be productive where fractured (Wierman et al., 2010).

Hammett Shale

- The Hammett-Cow Creek boundary, among others, is well described in Wierman et al. (2010). from geophysical logs. Geophysically, the “contact is a sharp break on the gamma log with an abrupt increase of CPS.” Lithologically, the contact is the first well-developed carbonate as you transition upward from shale.

Cow Creek

The Cow Creek stratigraphy is incorrect and needs to be corrected.

- See Hunt et al. (2011) for measured sections and Wierman et al. (2010) for other descriptions.
- The unit is NOT a calcarenite at the base in Hays County. Instead the unit grades from the Hammett Clay into a silty dolomite and into a calcarenite near the top of the unit. “The upper Cow Creek unit is normally a grain-skeletal limestone, with coarse quartz grains. The rocks are often fractured and dolomitized. The underlying dolomite is fine to medium crystalline, sucrosic, porous, gray-brown (“brown sands”) and typically water bearing.” (Wierman et al., 2010).
 - In many locations the Cow Creek is primarily dolomite (Al Broun, personal communication).
- The contact with the Hensel is an unconformity and a sequence boundary representing sea-level change with subaerial to near surface exposure over much of the report area (Owens and Kerans, 2010). The depositional history and diagenesis associated with this unconformity is critical to understanding recharge and groundwater flow for the Cow Creek (Wierman et al, 2010).
- See recent core work by the Hays Trinity Groundwater Conservation District for recent wells that core the Lower Glen Rose, Hensel, and Cow Creek (Broun and Watson, 2017 and 2018).

Hensel

The Hensel description could be enhanced. We agree in the updip portion the Hensel Sand is weakly cemented, but that facies doesn't cover much of the region as stated. Instead, in the subsurface in Hays County the unit transitions into a predominantly marine, silty, sandy, dolomite unit, about where the Ouachita thrust is mapped in Hays County. Shale is a component, but does not dominate the lithology in the downdip Hays County area, and so is not referred to as the Bexar Shale.

- From Wierman et al. (2010): "The Hensel is predominantly arkosic sandstone, pebble conglomerate and red-brown siltstone and claystone to the west in Blanco County. It thins and changes facies abruptly to the east-southeast, where upper Hensel clastics interfinger with Lower Glen Rose carbonate, shallow-water bank, and shoal lithofacies. The Hensel formation acts as a confining unit for the Cow Creek to the southeast, where the lithofacies is a fine-grained shale/claystone and dolomite."
- The subsurface facies transition is thought to occur near the Ouachita front (Wierman et al., 2010).
- See recent core work by the Hays Trinity Groundwater Conservation District for recent wells that core the Lower Glen Rose, Hensel, and Cow Creek (Broun and Watson, 2017 and 2018)

Lower Glen Rose

Almost no description is given to the Lower Glen Rose and its important reef facies.

- "Lower Glen Rose, about 250 ft thick, is characterized by fossiliferous limestone units with well-developed rudistid reef mounds and biostromes often found near the top and base of the unit." (Hunt et al., 2017).
- "The basal coral-rudist "mound/reef" lithofacies unit is equivalent to the "Narrows" biostrome. The upper caprinid "reef" unit is correlated to the Pipecreek reef in Bandera County (Perkins, 1974)." (Wierman et al., 2010).
- See recent core work by the Hays Trinity Groundwater Conservation District for recent wells that core the Lower Glen Rose, Hensel, and Cow Creek (Broun and Watson, 2017 and 2018).
- The Lower Glen Rose is very karstic, as are most of the Trinity carbonate units.

Upper Glen Rose—Lower Glen Rose contact

A critical component of the description of the units near the contact with the Upper Glen Rose and Lower Glen Rose is the presence of evaporite beds. These are critical to the hydrogeology as they are an effective aquitard, and influence the water quality. There is no mention of gypsum or anhydrite minerals in the report in this section.

- "The units have intervals of evaporite minerals that occlude the porosity and permeability (Figure 4). Some of these intervals consist largely of interlocking evaporite nodules. While some of these intervals have evaporite nodules separated by a dolomitic matrix. These units are characterized as having low permeability and porosity, poor water quality, and water levels that change very little." (Smith et al., 2018)

Upper Glen Rose

Upper Glen Rose stratigraphy and erosion play an important role in surface flows and recharge to the Middle Trinity Aquifer. Karstic development in thin, fractured carbonate units appears to allow hydrologic communication of the streams to the underlying Middle Trinity units (Hunt et al., 2016 and 2017; Watson et al., 2017).

- In outcrop, the Upper Glen Rose is subdivided into eight informal lithologic units, which correlate to the classic work of Stricklin et al. (1971). These units generally consist of stacked and alternating limestones, dolomites, mudstones, and marls (Hunt et al., 2017)
- Recent work has focused on mapping Upper Glen Rose "Unit 3" (Stricklin et al., 1971) within the Onion Creek watershed (**Figure 3**). Unit 3 is 50 ft thick and is identified in both surface outcrops and subsurface cuttings by the

presence of abundant *Orbitolina texana* (foraminifera) fossils in a calcareous mudstone. Mollusk steinkerns and skeletal fragments are also common in argillaceous, nodular grainstone, packstone, and clay units. Muller (1990) recognized Upper Glen Rose Unit 3 as an aquitard within upper Onion Creek watershed. Similar units are also recognized in recent mapping by the USGS (Clark et al., 2016; Watson et al., 2017).

Walnut Formation

There is some confusion about the stratigraphic nomenclature of the Kainer Fm vs the Walnut Fm (Hunt et al., 2011; stop 4). Where the Edwards Group is recognized in the Hill Country and BFZ, there is no Walnut Formation.

- The San Marcos platform influenced major facies changes from the deeper water rocks, characterized by interbedded marl and nodular limestones of the lower Fredericksburg strata (e.g. Walnut Formation), into shallower-water rocks characterized by grainstones and tidal flats (Ft. Terret Fm. of the Edwards Group). The Kainer formation has the Basal Nodular member at its base. However, the Basal Nodular Mbr of the Ft. Terrett Fm is stated to be equivalent to the Cedar Park Mbr near Austin according to Moore (1996) and Small et al. (1996). Thus, where the Edwards Group is recognized in the Hill Country and BFZ, there is no Walnut Formation. To complicate things, we sometimes use the term Walnut Formation because in Hays County, and especially Travis, we can recognize members of the Walnut Fm. This apparent contradiction should be described if the stratigraphic term Walnut Fm is used.
- Review new work on the regional stratigraphy and add citation of Rose (2016a).

2.2.4 Structural Geology

The maps in the document (Figure 2.2.4) reflect regional structures such as Llano Uplift, San Marcos Arch, Ouachita Front, and Laramide Front. However, a brief additional narrative of these structural elements, upon which the BFZ was developed, would be helpful and provide better context for future sections. These features influenced Cretaceous deposition and subsequent structures, such as the BFZ.

- The tectonic events described in detail in Ewing (1991) include the Grenville (pre-Cambrian), Ouachita (late Paleozoic), and Gulfian (Triassic to present) cycles. Ewing (2004) discusses the various arches forming the Llano Uplift. Ewing (2016) provides broad overview as well.
- Consider adding citations in the narrative: Ewing (1991); Ewing (2016); Collins (1995); Flawn et al. (1961), Rose (2016)
- When discussing the cause of the BFZ and the relative motion, Rose (2016) does not attribute its formation solely to subsidence into the GOM. Rather his contention is that the Plateau was uplifted. Mention of this as a potential mechanism with a citation is needed.
- Rose (2016a) also proposes the depth of burial of the sediments, which is important for diagenetic processes etc.
- Annotate structures in cross section Figure 2.2.7 (Ouachita vs BFZ)
- Fig 2.2.2 shows the axis of the “San Marcos Arch” cutting through Hays County. Isopach maps from Wierman et al. (2010) don’t show thinning. We suggest the axis could be moved south.
- Fig. 2.2.6. appears to show the arch as a structural flexure (anticline), which is not accurate.
- An important structure that is not specifically mentioned in this section are relay ramps. These are very important structures at all scales and have implications for descriptions of groundwater flow in future sections.
 - Grimshaw and Woodruff (1986) describe two en echelon faults and an associated relay-ramp structure in the San Marcos area that they hypothesize influenced the geomorphology and groundwater flow--namely the location of the Blanco River and San Marcos Springs. This same structure (Figure 1) is also mapped by Collins and Hovorka (1997).

- Citation could include: Grimshaw and Woodruff (1986); Collins (1995); Collins (2004); Collins and Hovorka (1997).
- “Structure contour surfaces revealed detailed structural geometries including linear zones of steep gradients (interpreted as faults) with northeast dipping zones of low gradients (interpreted to be ramps) between faults. Results for the Middle Trinity Aquifer suggest relay ramps provide a mechanism for lateral continuity of geologic units...” (Hunt et al., 2015). These ramps will be critical to the understanding of the eastern extent of the aquifer into the BFZ.

Karst in the Upper and Middle Trinity

There is no discussion about karst development in the Upper Glen Rose, Lower Glen Rose, and Cow Creek Limestone. All three of these units have extensive karstic development and include major caves such as Natural Bridge Caverns (UGR), Honey Creek Cave (LGR; the longest cave in Texas), Jacobs Well Spring (CC), Pleasant Valley Spring (CC), Spring Branch (CC), Coal Spring (LGR), and many 100s of other documented caves located in the region in Trinity Group limestones. A section including statistics from the Texas Speleological Survey (TSS) for caves and karst features in the area is a critical omission from the geologic evolution of the aquifers as karstic groundwater flow is pervasive in many sub-regions of the aquifer. See also comments for section 4. An example of mapping karst in the Trinity from the TSS is provided in Wierman et al. (2010).

Previous Investigations

At the bottom of the second paragraph there is discussion about the updated conceptual model in the report to include the downdip/confined portions of the Trinity Aquifer to assess the interformational flow with the Edwards BFZ Aquifer. While true, the report should also assess the intraformational flow of the Trinity Aquifers from the Hill Country into the BFZ. A lot of work has been done on both the inter- and intraformational flows and portions of the conceptual model, most recently summarized in Smith et al. (2018) and figure below.

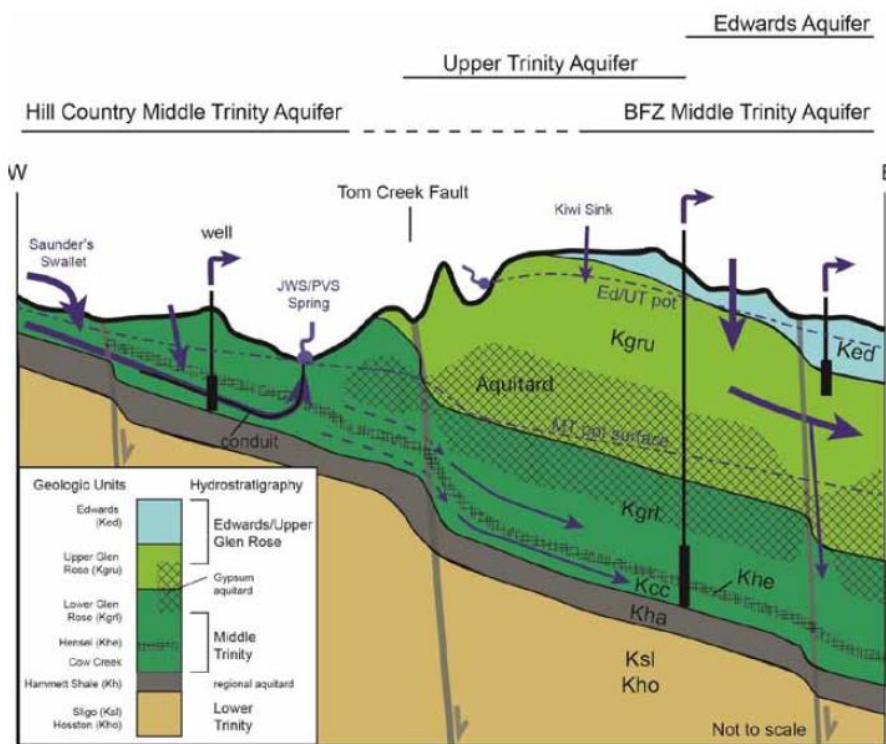

Figure 12. Schematic cross section and conceptual model.

4.0 Hydrologic Setting

This section should include a section on the influence that the karst development has on hydrology-- a key in formulation of the conceptual model (Smith et al., 2018).

- Karst is pervasive throughout the aquifers in varying degrees.
- Zones of karst that are especially important include Cibolo Creek, Cypress Creek, and the Blanco River to name a few.
- There are many known point recharge features such as Saunders Swallet, as well as many upland caves and sinkholes. Most springs in the Hill Country are karstic in nature.

4.1 Hydrostratigraphy and Hydrostratigraphic Framework

The narrative could describe how the aquifer has historically been described, but then contrast that with the recent work that has refined that understanding.

- The Edwards Aquifer BFZ in Hays County does not stop at the top of the Upper Glen Rose, but is now recognized to include a variable thickness of the uppermost 100-200 ft of the Upper Glen Rose. See Smith and Hunt (2010); Wierman et al. (2010); Wong et al. (2014).
- The third paragraph describes the Trinity as occurring west of the BFZ, and not the portion beneath the Edwards. Recent work describes the Trinity as it extends beneath the Edwards to the east:
 - The Middle Trinity has been described as two interconnected aquifer zones: 1) Hill Country Middle Trinity to the west, and 2) Balcones Fault Zone (BFZ) Middle Trinity to the east (Hunt et al., 2017a).

4.1.1 Hydrostratigraphic characterization

The geologic descriptions (lithologies, karst) noted above are key to the hydrostratigraphy and should be referenced in this section.

4.1.2 Fault Model

The way we understand the regional approach used to create the structure surfaces was by: 1) integrating an existing fault model, then 2) contouring the surfaces. For a large region in the Hill Country, with sparse data such as this, that is a good approach. However, there is likely good subsurface data in the BFZ. So, where there is dense subsurface data available an additional approach could be explored. This would include structure surfaces contoured without a fault model, which can then reveal large structures such as faults and relay ramps. This is true for Hays, Travis, and Blanco counties. Future detailed work in those counties could explore that approach as corroborating the existing fault models. The example of this approach is from Hunt et al. (2015).

- It is not clear in the discussion which fault model was selected for use in the study. Figure 4.1.2 indicates faults modeled in this study, but those faults appear incomplete as the Mt. Bonnell and Tom Creek Faults in Hays and Travis are not included. The Fratesi et al. (2015) model appears to be the more complete, but is not clear if it was used as the final fault model.
- In the last paragraph some discussion of relay ramps, mentioned above, is needed and how that may affect the lateral continuity of units. Published maps of Collins and Hovorka (1997) use subsurface data and the geologic maps to indicate the location and direction of the ramps. Locations of those on the structure contour figures is warranted.

4.1.3 Hydrostratigraphic Framework Model

There are some anomalies in the final structure and isopach maps in Hays and Travis Counties that should be corrected, identified, and explained.

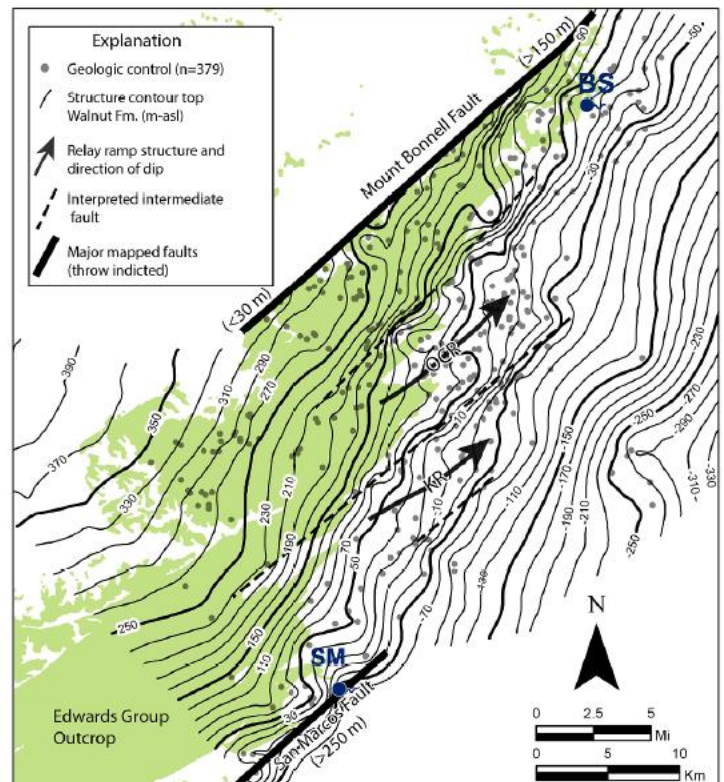

Figure 4. Structure contour map of the top of the Walnut Formation—the base of the Edwards Aquifer. Two relay ramp structures are drawn where gradients flatten out between large faults. The two ramps are named Onion Creek Ramp (OCR) and the Kyle Ramp (KR). Contouring was done without faults in Surfer®. To illustrate the geometry of the relay ramp, faults were drawn where contouring supported their presence—these generally coincide with faults mapped in the Geologic Atlas of Texas (Stoeser, 2005).

- Structure and isopach figures 4.1.8-13 show errors in elevation and thickness of the units in the linear colorless area spanning Travis and Hays.
- Figure 4.1.15 shows that the Hensel thickens from NW to SE. This is opposite of what the data indicate. The Hensel is thickest in the NW (~70 ft) and thins to the SE (~30 ft) (Wierman et al., 2010).
- The Cow Creek isopach map does not appear to match the data (Wierman et al., 2010). Figure 4.1.17 shows the thickness of the Cow Creek as too thick (100-250 ft) in Hays County. While there are small areas of up to 115 ft, the extent and the orientation appear contrary to Wierman et al. (2010). Perhaps keep the isopach bins as 50 ft intervals rather than jump to 150 ft.
- Figure 4.1.19 shows the Hammett as far too thick in Hays and Travis Counties. In Hays County the variation is from 70-40 ft and is generally consistent at about 40 ft (Wierman et al., 2010). We know of no places with >100 ft of Hammett Shale in Hays, Travis, or Blanco counties as the map shows.

4.2 Water Elevations and Groundwater Flow

4.2.3 Creation of Water-Level Contours

The approach of compartmentalizing water-level data in two separate domains of the HCT and BFZ can provide erroneous interpretations of the data. However, an additional approach of contouring the data as one single domain is also warranted. Compartmentalizing the data artificially segments the potentiometric surface (such as figure 4.2.1.9). With a single domain the data itself can highlight areas of compartmentalization.

The potentiometric maps presented are not useful to indicate general flow processes. Some of it could be related to scale and the number of contours, but more work should be done to cull the data into representative data sets that would indicate flow processes and provide calibration targets. Historic maps should be presented as background and guiding those efforts (Mace et al., 2001). The BSEACD and others have produced a March 2018 potentiometric map that illustrates key hydrogeologic processes.

In Hays and Travis Counties we see evidence for both hydrologic isolation and continuity from the HCT to the BFZ Trinity. Those data sets include those published in Mace et al. (2001) and Hunt et al. (2010). In addition, a recent unpublished potentiometric map produced in March 2018 further confirms the previous maps. Below is the map produced from that recent effort that is similar in shape to previous maps.

It is important to emphasize in the conceptual model that we do NOT assume a large amount of lateral flow from the Middle Trinity into the Edwards in Travis and most of Hays Counties. We point to various data most recently summarized in Smith et al. (2018) and Hunt et al. (2017). In addition, the water budget of the Barton Springs segment of the Edwards Aquifer does not require a large influx (Slade et al., 1986 and Hauwert, 2016) as it may in the San Antonio segment of the Edwards Aquifer. It is unknown where the lateral flow of the Middle Trinity ultimately discharges in Hays and Travis Counties, but it does not appear to be significant in the freshwater portion of the Barton Springs segment of the Edwards Aquifer. However, that is not to say that there is not some lateral cross formational flow from the Middle and Upper Trinity units.

Upper Trinity Hydrostratigraphic Unit

Perhaps restate that in Hays County in the BFZ we see the upper-most upper Trinity hydrologically connected to the overlying Edwards Aquifer and the lower units behave as an aquitard.

4.2.6 Transient Water Elevation Data in Individual Wells

The hydrographs provided and discussed would benefit from having select hydrographs as figures as full pages with multiple well data on them and perhaps annotations of key drought periods.

- We agree that the response to wells near the outcrop may also be related to their proximity to the recharge areas, but the difference in response may also be related to the difference in unconfined vs confined conditions and the presence of karstic conduits such as the JWS area (Wierman et al., 2018).
- The discussion about trends would be helpful to cite other works that have looked at similar trends, such as the recent report of the TWDB (Neffendorf and Hopkins, 2017, Table 7-1).
- Hunt and Smith (2016) discusses the Middle Trinity Aquifer as under stress, with overall declining water levels of about 1.3 ft/yr. However, the depletion of the aquifer is spatially variable with some areas indicating recovery, while much of the area shows overall declines.
- Additional reports that relate to individual trends and hydrographs, especially related to the Middle Trinity, include Hunt et al. (2012, Figure 12); Wierman et al. (2018, Figure 8).

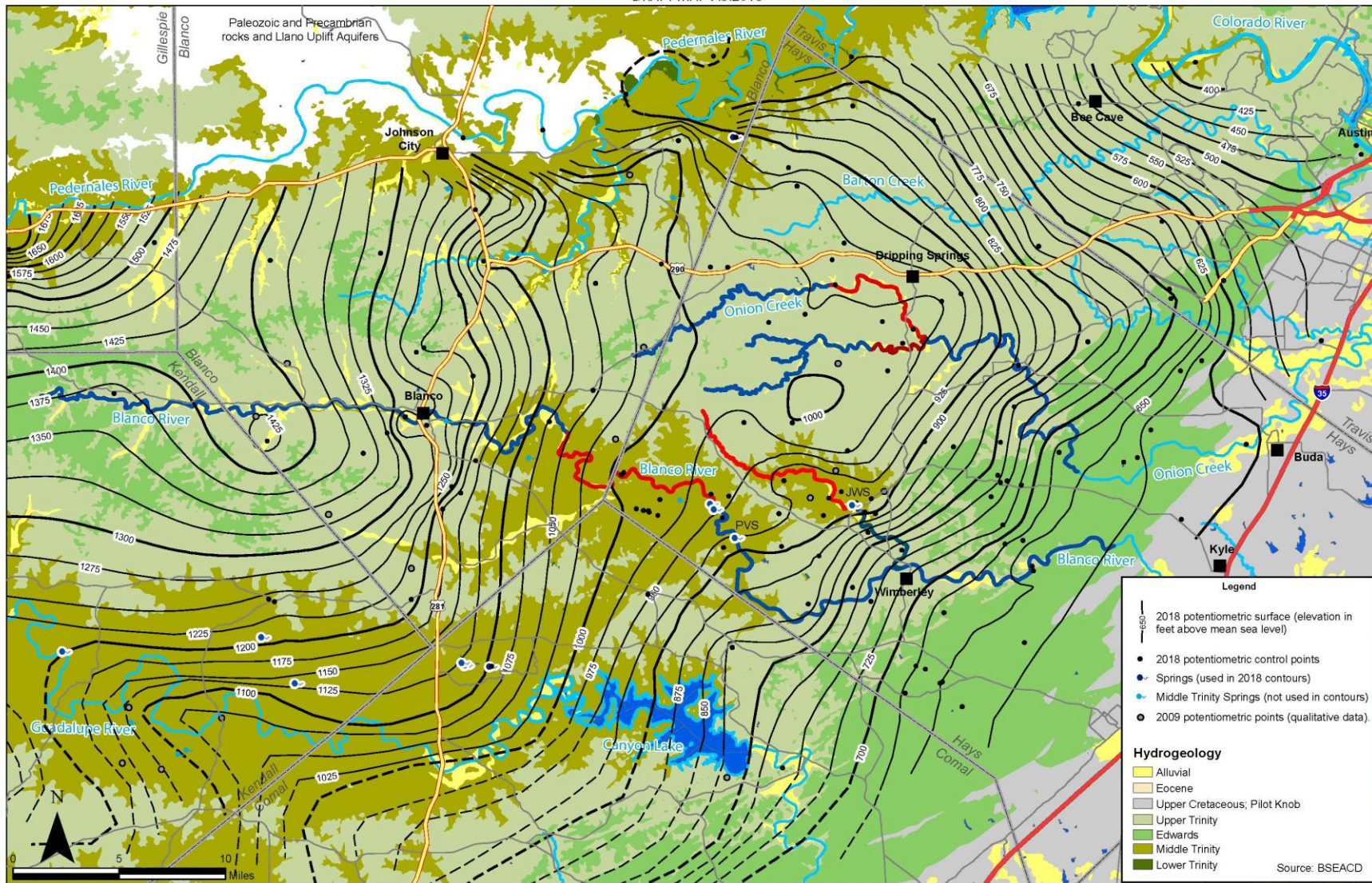

Recent unpublished (BSEACD) potentiometric map of the Middle Trinity Aquifer (March 2018). These data are available upon request.

4.2.8 Cross Formational Flow

4.2.8.1 Vertical Flow within the Trinity Hydrostratigraphic Units

We agree with the conclusion that there is generally a high resistance to cross-formational flow between the Upper, Middle, and Lower Trinity units. Recent publications discussing the separation include Wierman et al. (2010); Wong et al. (2014); Smith et al. (2018).

However, there are some areas where this may not be the case and there is at least some vertical hydrologic communication, albeit restricted. Areas of increased vertical communication are areas where facies allow greater vertical permeability, or where faults and fractures increase permeability locally.

- In the updip areas of the aquifer, particularly in Kerr County, the Hammett Shale is known to be absent or very thin and the hydrologic separation of the Lower and Middle Trinity aquifers may not be complete.

In addition, there could be some discussion about the vertical flow within each aquifer unit themselves. For example, the communication between the Cow Creek and the Lower Glen Rose units of the Middle Trinity.

- Where the Hensel is clastic and relatively thick in the west, it may allow for easy vertical communication within the Middle Trinity Aquifer. However, in the eastern portion, as the facies changes to a silty dolomite, the unit may behave as a leaky barrier to flow that is locally breached with fractures and faults.
- Recent modeling and aquifer tests within the BFZ Trinity provide some discussion of this aspect and estimates of aquifer parameters include: Intera (2018), BSEACD (2017 and 2018)

4.2.8.2 Cross-Formational Flow Between the Trinity Hydrostratigraphic Units and Underlying or Overlying Aquifers

In the Hill Country Trinity, the Upper Glen Rose generally inhibits flow into the underlying Middle Trinity Aquifer, although some leakage is likely, at a minimum. It is complicated, but there is a lot known about the Upper Trinity in some areas that provides insight into its behavior.

- Vertical communication occurs where the Upper Trinity units are thin, certain units are exposed, or along fractures and karst features. Recent studies in Hays County along Onion Creek have shown fast vertical flow through the lower-most members of the Upper Trinity into the Middle Trinity (Hunt et al., 2017; Watson et al. 2017 and 2018).
- Other studies show where the units of the Upper Trinity are deeply confined (such as in the BFZ) and evaporites are present, those units can behave as an aquitard between the Upper and Middle Trinity and the Edwards Aquifer (Wong et al., 2014; Smith et al., 2018).
- The studies by Wong et al. (2014) suggest a vertical communication between the Edwards and the uppermost units of the Upper Glen Rose. Those units of the Upper Trinity (~150 ft) are part of the Edwards Aquifer.
- Wong et al. (2014) does NOT support lateral communication between the Upper Trinity units and the Edwards as stated in the report. However, other studies do suggest a lateral communication with upper units of the Upper Trinity and the Edwards Aquifer. Those include potentiometric maps in Hunt et al. (2007, Figure 21) in Hays County and dye tracing by the EAA (Johnson et al., 2010) in Bexar County.
 - “Minor inflows (inter-formational flow) from the Upper Trinity Aquifer of the Hill Country into the BSEA [Barton Springs segment of the Edwards Aquifer] is suggested by potentiometric data and geochemistry (Senger and Kreitler, 1984; Garner and Mahler, 2007; Hunt et al., 2007). Recent studies do not support substantial inflows from the Middle Trinity Aquifer in the BSEA as they are reported in the San Antonio segment (Mace et al., 2000; Anaya et al., 2016). Instead, groundwater flow within the Middle Trinity of the Hill Country is thought to remain within the Middle Trinity units as it flows east into the BFZ and beneath the BSEA (Hunt et al., 2015). The Middle Trinity is vertically isolated from the overlying BSEA (Smith and Hunt, 2010; Wong et al., 2014)” (from Hunt et al in review). In addition, the water budget of

the Edwards does not require a large influx (Slade et al., 1986 and Hauwert, 2016) as it may in the San Antonio segment of the Edwards Aquifer.

4.3 Recharge

Recharge is the hardest component of the water budget to estimate and constrain. However, increasing the quantification of discharge will improve the constraints on recharge (see comments on discharge below). The section on recharge however does not really describe recharge to the system, per se. Instead a modeled theoretical amount of recharge is provided. While this may be the best tool for estimating recharge, without the background and discussion of the recharge processes at work, the utility of this approach is questionable.

- There is an apparent absence of review of published recharge, runoff, and ET studies in the Hill Country Trinity that should be reported and evaluated. These include Banta and Slattery (2011); Slattery et al. (2006); and Dugas et al. (1998).
 - “Over a 5-year water balance of the Trinity Aquifer in Uvalde County, Dugas et al. used Bowen ratio tower to calculate that 65% of rainfall evaporated or transpired, 5% of rainfall flowed as runoff into creeks, and 30% of rainfall recharged the underlying aquifer [34].” (Hauwert and Sharp, 2014)
- In addition to those previous studies it could be useful to evaluate other recharge estimate methods and techniques—such as those described in Scanlon et al (2002), and a spreadsheet tool called ESPERE (Lanini et al., 2015), which combines published empirical and analytical methods including Turc (1954), Kessler (1967), Guttman and Zuckerman (1995), and Healy and Cook (2002).
- Results of the recharge estimates should also be compared to the existing literature in a simple table. Perhaps stated as the average and range of values as a percent of annual precipitation, which is commonly cited. This also should be quantified and presented in a simple table describing the water-budget section.
- One aspect that is missing in the narrative is the karstic processes related to recharge. One key concept is that there are areas where the geology of the Hill Country Middle Trinity is comparable to the Edwards Aquifer recharge zone due to its karstic nature. Those include parts of Cibolo Creek and the Blanco River.
 - “The Hill Country Middle Trinity Aquifer zone has areas similar to the karstic Edwards Aquifer. Recharge occurs through discrete karst features and losing streams, and diffusely through permeable rock outcrop. Matrix, fracture, and karst permeability are all present, and natural discharge occurs at major springs” (Hunt et al., 2017).
- We are very glad that focused recharge is addressed in the report within the streams such as the Blanco River that was historically seen as a perennial gaining stream. However, it is unclear if the reaches of gaining and losing segments are reflected accurately based on the maps provided. The method used to estimate focused recharge entirely ignores surface water patterns in reaches where significant loss occurs over long periods of time between precipitation events. This is observed in gage data and gain loss surveys on the Blanco, Guadalupe, Medina, and Nueces Rivers, at a minimum.
- When synthesizing the data, there could be areas or zones of the Middle Trinity that are delineated as effective recharge zones. This would integrate the geology, lithology, geochemistry, karst, and losing streams into such zones. This would be key to the conceptual model.
- The method used to compute diffuse recharge could implement more accurate datasets to compute PET or ET, and not lake evaporation, which represents a significantly different process in the water balance. The use of the antecedent conditions coefficient is a vague way to account for varying temporal controls on recharge. The fact that this value is changed solely as a function of getting a numerical groundwater model to calibrate implies that there is no independent, process-based input to this approach, but it only uses the coefficient as a tool to make the water budget balance.

- In the second paragraph addressing work done on the Barton Springs segment the following may be useful: “Water-balance and geochemical studies indicate the majority of recharge occurs within streams that cross the recharge zone (Slade et al., 1986; Slade, 2014; Wong et al., 2012; Hauwert and Sharp, 2014; Slade, 2015; Hauwert, 2016). The studies summarized used different approaches, assumptions, and often during different hydrologic conditions. Despite different values, the overall conclusions and ranges of values are complementary, and all the studies conclude that the majority of the recharge occurs within streams. The reported range of recharge compared to discharge is from 56-75% from mostly allogenic sources, and 25-44% from within the recharge zone (autogenic, and other minor sources)” (Hunt et al, in review).
- It appears in Figure 4.3.7 and 4.3.8 that all the stream reaches are treated as gaining streams. Some of this is the result of the large grid size; however, in Hays County the reaches of gaining and losing have been mapped in a simplified manner (figure below from Hunt et al., 2017).

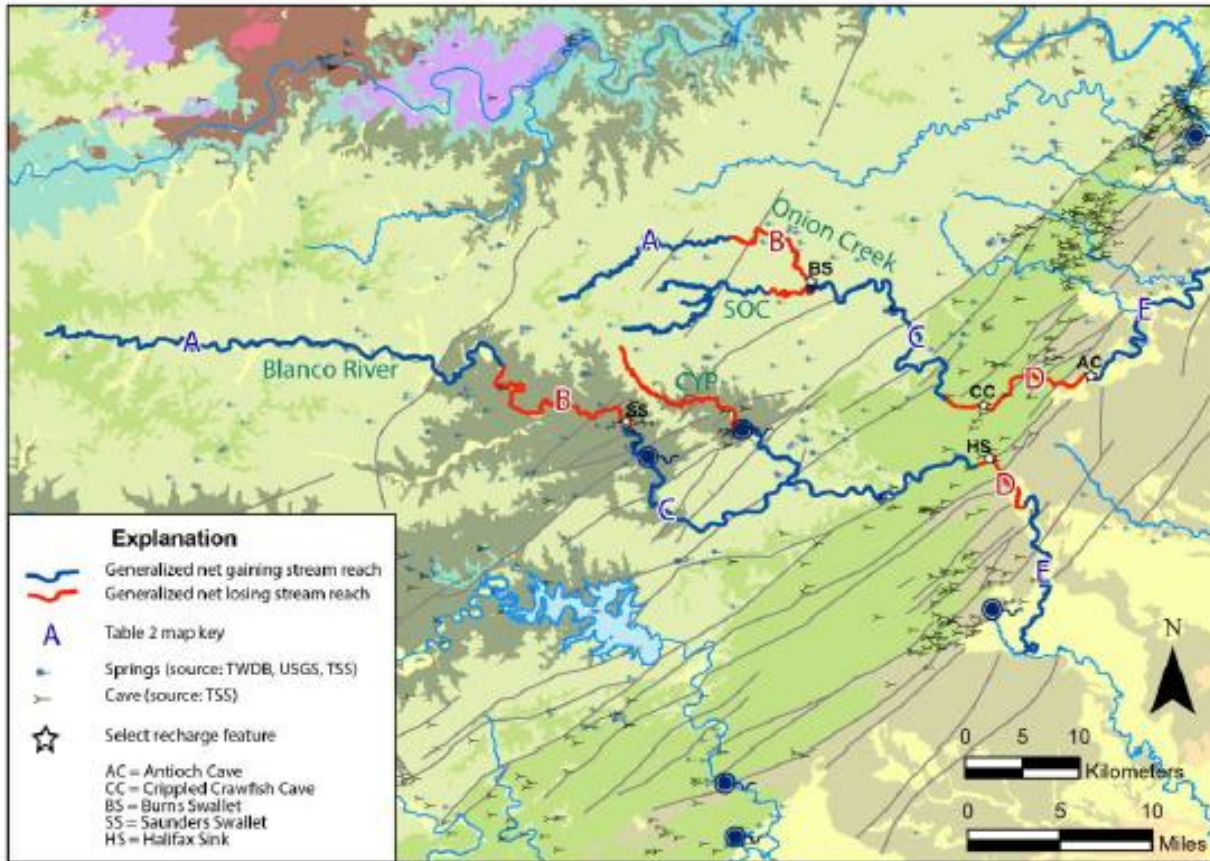

Figure 6. Summary of flow gain-loss map of Blanco River and Onion Creek watersheds. Table 2 provides description of reach. SOC= South Onion Creek; CYP= Cypress Creek. Data summarized from (Smith et al., 2014 and Hunt et al., 2016).

Rivers, Streams, and Lakes

Synoptic studies of gains and losses are provided for much of Travis, Hays, and Blanco Counties. A little bit of a narrative about the lakes could enhance the understanding. For example, are the lake bottoms in direct contact with units of the Middle and Lower Trinity? Do the lakes and rivers provide sources of surface and groundwater interaction? These are key questions affecting the boundary conditions of the model and should be posed if not attempting to address.

- The reference TAMU (2018) was not found in the references.

- Are there historical (pre-dam) reports about the surface and groundwater interactions (TWDB, 1960)? For example, along the Colorado, are there reports of gains where the Middle Trinity is exposed and therefore would indicate it as the primary discharge point of the Middle Trinity?
- Gain-loss citations include: Wierman et al. (2010, synoptic of 2009 in Blanco), Hunt et al. (2017, Blanco and Onion, see figure above); Wierman et al. (2017, Pedernales River), Kromann (2015, Nueces River).
- Figure 4.4.5. Indicate if the values are absolute flow values, rather than gain-loss values.

4.5 Hydraulic Properties

A summary table and figure should be provided that includes the range of measured or estimated values along with values from the literature and previous GAM studies. An example could be something like the figure below:

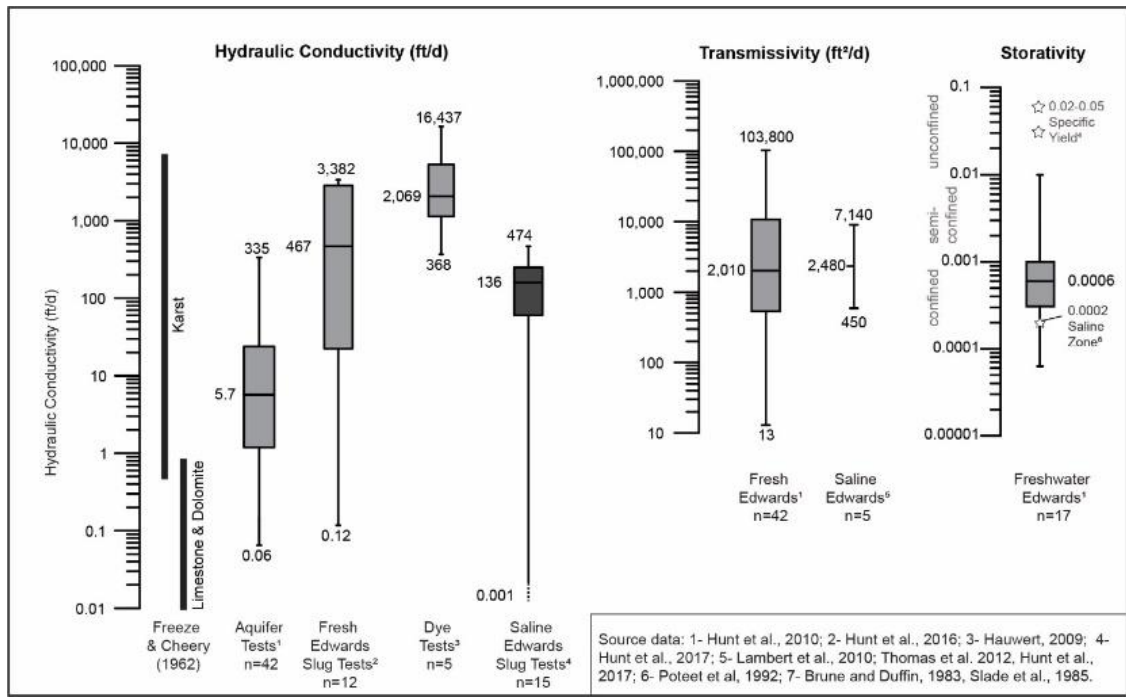

Example figure of parameters from the Barton Springs segment of the Edwards Aquifer (Hunt et al., in review).

4.5.6 Vertical Hydraulic Conductivity

Describe and cite the work of Intera (2018). This may be one of the only assessments, calibrated to data, of the vertical hydraulic conductivity of the units.

4.6 Discharge

Significant effort should be made to characterize, describe, and quantify all forms of measurable discharge and other estimates of cross-formational flow. It bears repeating that since recharge is the most complex and difficult component of the water budget, discharge needs to be quantified to the highest level possible. Much of it can be observed and measured, such as springflow and pumping. In addition, for a groundwater availability model it is capture that we are likely to be most concerned about in terms of impacts, and that will likely mean capture of discharge. For more on this reason to focus on discharge, see Bredehoeft (2007).

4.6.1 Springs

There are a number of large, artesian springs that flow from the Middle Trinity Aquifer, and in some cases, these are gaged by USGS stream gages under base flow conditions. These include:

- Pleasant Valley Spring – gauged by USGS at 08170950
- Jacob’s Well Spring – gauged by USGS at 08170990
- Coal Spring – gaged by USGS at 08178980

Although some of these records are not as long running as other gauges discussed in the report, it should be mentioned that significant natural discharge flows from these major springs, and should be directly included in the conceptual model, and used as calibration points in the groundwater model. However, many springs are ungauged such as the Spring Branch area of the Guadalupe River produce significant amounts of natural discharge from the Middle Trinity aquifer.

- Except for Jacob’s Well and Pleasant Valley Spring, the named springs in the study area discharge from the Edwards Group. We do not see the value of this table without additional springs and parameters. A thorough search of springs from Brune (1978) and the TWDB well database is needed. An additional source is the USGS springs database of Texas (Heitmuller and Reece, 2003) (<https://pubs.er.usgs.gov/publication/ofr03315>).
- Table 4.6.1 should provide more basic data for the relatively major springs of the area with an emphasis on Trinity springs. These would be the springs that could be calibration targets for numerical modeling. There should be a representative sampling of the springs from the various aquifers, and geographically distributed. There are many springs in the Trinity, but perhaps limit the table to those with additional information, such as flow. Examples include:
 - Park Spring along the Blanco River
<http://www2.twdb.texas.gov/apps/waterdatainteractive//GetReports.aspx?Num=5763707&Type=GWD>
[B](#)
 - Klepac Spring (Blanco River, possible artesian Middle Trinity Spring)
<http://www2.twdb.texas.gov/apps/waterdatainteractive//GetReports.aspx?Num=5761227&Type=GWD>
[B](#)
 - Rebecca Spring (Guadalupe River tributary)
<http://www2.twdb.texas.gov/apps/waterdatainteractive//GetReports.aspx?Num=6806403&Type=GWD>
[B](#)
 - Coal Springs (Medina River)
<http://www2.twdb.texas.gov/apps/waterdatainteractive//GetReports.aspx?Num=6817403&Type=GWD>
[B](#)
 - Candelaria Spring (Nueces River, Uvalde Gravel, see M. Gary for flow measurements and source aquifer)
<http://www2.twdb.texas.gov/apps/waterdatainteractive//GetReports.aspx?Num=7032604&Type=GWD>
[B](#)
- The table could easily provide more information such as:
 - Aquifer unit
 - State well ID
 - Range of flow (cfs)
 - Chemistry (TDS)
 - Comments
 - An estimate for the percentage of baseflow to a given river reach should be provided if available. For example, JWS historically provided up to 25% of baseflow to the Blanco River at Wimberley, and PVS provided the remainder (TWDB, 1960)

4.6.2 Aquifer Discharge Through Pumping

It is unclear if the data on pumping considered the compilation of pumping by GCDs for 2008 that is contained within the GMA 9 Explanatory Report (GMA 9, 2016). The table below could provide some constraints on the pumping estimated

from the methods described in the report. The GCDs directly provided pumping, and where a GCD is present, those 2008 values likely represent the best available information and could be compared to the estimates provided in the report.

However, where the GCDs did not provide data such as Comal and western Travis County, those numbers need further scrutiny. For example, in western Travis County we see evidence for much of the Middle Trinity being depleted and accordingly most of the wells and pumping may in fact be derived from the Lower Trinity. Drilling trends are almost exclusively for the Lower Trinity in NW Hays and western Travis County (Wierman in Hunt et al., 2011). In addition, the pumping values in western Travis County appear far too high.

- Figures 4.6.3 through 4.6.5 are deceptive in that the figures indicate into which hydrostratigraphic unit the wells were spudded, not the units producing water and being pumped. For example, most of Hays County appears to be drawing water from the Upper Glen Rose when much of the water is pumped from the Middle Trinity (see Table 4.6.4).
- Aquifer discharge via pumping from the HCT can also occur by pumping lower, non-HCT, aquifers. For example, water discharges downward through the Hensel in Gillespie County due to pumping in the underlying Ellenburger Aquifer. There are large pumping centers, such as the City of Fredericksburg, that utilize the Ellenburger. Pumping in Fredericksburg occurs near the Pedernales River and has, over time, reduced flow in the river and may have created a losing reach in the river (Wierman et al, 2017).
- 4.6.10 Individual GCD pumping records should be considered as a source of data for municipal and industrial well locations. For example, in Hays County, the Dripping Springs Water Supply Corporation wells are indicated as not having a TWDB pumping record. These wells are some of the largest producers from the HTC in Hays County and routinely report pumping data to the HTGCD.

Table 33. Estimated 2008 Trinity Aquifer Pumping Provided by GMA-9 Groundwater Conservation Districts (by County) (in ac-ft)

County	Upper Trinity Aquifer	Middle Trinity Aquifer	Lower Trinity Aquifer	Total Pumping
Bandera	288	3,567	515	4,370
Bexar	693	14,110	197	15,000
Blanco	77	1,477	0	1,554
Comal	398	5,788	0	6,186
Hays	416	4,800	449	5,665
Kendall	300	6,060	325	6,685
Kerr	213	6,263	5,534	12,010
Medina	0	500	1,000	1,500
Travis	551	4,967	0	5,518
Totals	2,936	47,532	8,020	58,488

Source: Hutchison, 2010

5.0 Conceptual Model of Flow in the Aquifer

Many of the suggested edits above should be reflected in the conceptual model. The area that we focus upon is shown in Figure 5.1.7 (Hydrostratigraphic cross section) and 5.1.8 (Block diagram).

- Figure 5.1.8 needs a spring arrow discharging from the Middle Trinity.
- A downward flow arrow from the Hensel into the Pre-Cretaceous. Given where the sections are drawn, there is no recharge to surficial Hensel shown in Gillespie County.
- The block diagram appears overly complicated and is difficult to decipher. The doubled-headed cross boundary flow arrows appear to flow against the down-gradient flow. The diagram would benefit from simplification. One

suggestion is to modify the previous conceptual model diagram in Jones et al. (2011). That would indicate what is new, and with a familiar simple diagram.

5.2 Hydraulic Designation of HCT Conceptual Model Boundaries

The Colorado River as a no-flow boundary may only be appropriate for the Upper Trinity Aquifer where the units are completely bisected. Potentiometric contours of the Middle Trinity indicate flow toward the Colorado River and in fact toward a large potentiometric decline in the Northern Trinity centered around Waco. More work needs to be done on this boundary, but a no-flow boundary may not be appropriate for portions of the aquifer.

5.3 Discharge

Where discussing intraformational flow (last paragraph pg. 240), we do not recognize the Bexar Shale as occurring in Hays County and therefore a no-flow boundary between the Cow Creek and Lower Glen Rose. The Hensel may be a leaky aquitard, but there is vertical communication (BSEACD, 2017; Intera, 2018; Broun and Watson, 2018).

5.6 Water Budget

A table that summarizes the various components and ranges of values of the water budget is needed. These could include a variety of new estimates provided by the report and published estimates from previous studies.

The conceptual model (Figure 6-1) is our best understanding of regional groundwater flow in the Hill Country portion of the Trinity Aquifer System.

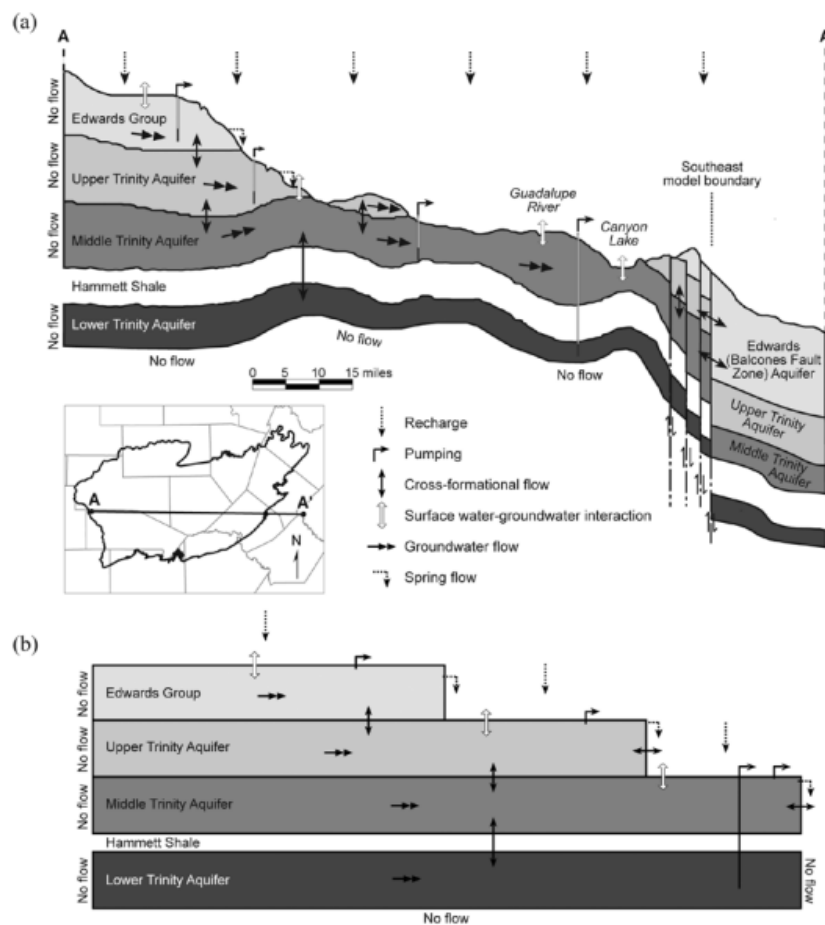

Figure 6-1. Conceptual model of the Hill Country portion of the Trinity Aquifer System. (a) Schematic cross section through the aquifer system. (b) Diagram showing the boundary conditions at the outer edge of the model, flows between the layers, and translation of the conceptual model into the numerical model (modified from Mace and others, 2000).

References

- Banta, J.R. and Slattery, R.N. (2011) Effects of Brush Management on the Hydrologic Budget and Water Quality in and Adjacent to Honey Creek State Natural Area, Comal County, Texas, 2001-10. US Geological Survey SRI Report 2011-5226, Reston, 34.
- BSEACD, 2017, Hydrogeologic Setting and Data Evaluation: 2016 Electro Purification Aquifer Test, Cow Creek Well Field: Hays County, Texas. Barton Springs Edwards Aquifer Conservation District, Technical Memo 2017-1010, 39 p.
- BSEACD, 2018, Aquifer Parameter Estimation for the EP Well Field, Hays County, Texas. Barton Springs Edwards Aquifer Conservation District, Technical Memo 2018-0213, 28 p.
- Bredehoeft, J., 2007, It is the Discharge. Groundwater Vol. 45. No. 5. Pg. 523
- Broun, A.B., and J. Watson, 2017, HTGCD Skipton Dedicated Monitor Well: Summary of Drilling Operations and Well Evaluation. Hays Trinity Groundwater Conservation District. HTGCD Technical Report 2017-1227. December 2017. 49 p.
<http://haysgroundwater.com/research/aquifer-science>
- Broun, A.B., and J. Watson, 2018, HTGCD DSISD Dedicated Monitoring Wells: Summary of Drilling Operations and Well Evaluation. Hays Trinity Groundwater Conservation District. HTGCD Technical Report 2018-0502. May 2018. 48 p.
<http://haysgroundwater.com/research/aquifer-science>
- Collins EW. 1995. Structural Framework of the Edwards Aquifer, Balcones Fault Zone, Central Texas. Gulf Coast Association of Geological Societies Transactions 45: 35-142.
- Collins EW, Hovorka SD. 1997. Structure map of the San Antonio segment of the Edwards Aquifer and Balcones Fault Zone, South-Central Texas. Structural framework of a major limestone aquifer: Kinney, Uvalde, Median, Bexar, Comal, and Hays Counties. The University of Texas at Austin, Bureau of Economic Geology Miscellaneous Map No. 18. Scale 1:250,000, 14 p.
- Collins EW. 2004. Summary of the Balcones Fault Zone, Central Texas: a Prominent Zone of Tertiary Normal Faults Marking the Western Margin of the Texas Coastal Plain. In: Hoh A, Hunt B, editors. Tectonic History of Southern Laurentia: A look at Mesoproterozoic, Late-Paleozoic, and Cenozoic Structures in Central Texas, Austin. Geological Society Guidebook 24. p. 81-89.
- Dugas, W.A., Hicks, R.A. and Wright, P. (1998) Effect of Removal of *Juniperus ashei* on Evapotranspiration and Runoff in the Seco Creek Watershed. Water Resources Research, 34, 1499-1506. <http://dx.doi.org/10.1029/98WR00556>
- Ewing, T.E. 1991. Structural Framework, in Salvador, A., editor, The Gulf of Mexico basin: Geological Society of America. The Geology of North America J: 31-52.
- Ewing TE. 2004. Phanerozoic Development of the Llano Uplift, In Hoh A, Hunt B, editors. Tectonic History of Southern Laurentia: A look at Mesoproterozoic, Late-Paleozoic, and Cenozoic Structures in Central Texas. Austin Geological Society Guidebook 24. p. 25-37.
- Ewing, T.E., 2016, Texas Through Time: Lone Star Geology, Landscapes, and Resources, University of Texas at Austin, Bureau of Economic Geology 431 p., 2016.
- Flawn, P.T., A. Goldstein, Jr., P. B. King and C. E. Weaver, 1961, The Ouachita System: University of Texas, Austin, Bureau of Economic Geology Publication 6120, 401 p.

- GMA 9, 2016, Groundwater Management Area 9 Explanatory Report for Desired Future Conditions Major and Minor Aquifers, Blanton & Associates and LBG Guyton, Report April 18, 2016. 191 pg.
- Grimshaw TW, Woodruff Jr CM. 1986. Structural Style in an En Echelon Fault System, Balcones, Fault Zone, Central Texas: Geomorphologic and Hydrologic Implications. In Abbott PL, Woodruff Jr CM, editors, The Balcones Escarpment, Central Texas, Geological Society of America. p. 71-76. Available from: http://www.lib.utexas.edu/geo/balcones_escarpment/pages71-76.html
- Hauwert, N., 2016, Stream Recharge Water Balance for the Barton Springs Segment of the Edwards Aquifer, Journal of Contemporary Water Research & Education, Issue 159, Pp. 24-49, December 2016.
- Hauwert, N.M. and Sharp, J.M. (2014) Measuring Autogenic Recharge over a Karst Aquifer Utilizing Eddy Covariance Evapotranspiration. Journal of Water Resource and Protection, 6, 869-879. <http://dx.doi.org/10.4236/jwarp.2014.69081>
- Hunt, B.B., B.A. Smith, and J. Beery, 2007, Potentiometric maps for low to high flow conditions, Barton Springs segment of the Edwards Aquifer, Central Texas: Barton Springs/Edwards Aquifer Conservation District, Report of Investigations 2007-1201, 65 p. +CD. December 2007.
- Hunt, B.B., D.A. Wierman, A.S. Broun, C.M. Woodruff, and R.G. Fieseler, 2011, Surface to Subsurface Trinity Lithostratigraphy: Implications for Groundwater Availability in the Hill Country, Easter Blanco and Northern Hays Counties, Texas: Austin Geological Society Guidebook 33, 24 p. + Appendices, November 2011.
- Hunt, Brian B., Smith, Brian A., Slade Jr., Raymond., Gary, Robin H., and Holland, W. F. (Kirk), 2012, Temporal Trends in Precipitation and Hydrologic Responses Affecting the Barton Springs Segment of the Edwards Aquifer, Central Texas: Gulf Coast Association of Geological Societies Transactions, 62nd Annual Convention, October 21-24, 2012, Austin, TX.
- Hunt, B.B., B.A. Smith, A. Andrews, D.A. Wierman, A.S. Broun, and M.O. Gary, 2015, Relay ramp structures and their influence on groundwater flow in the Edwards and Trinity Aquifers, Hays and Travis Counties, Central Texas, Sinkhole Conference, October 5-10, 2015, Rochester, Minnesota
- Hunt, B. B., A. S. Broun, D. A. Wierman, D. A. Johns, and B. A. Smith, 2016, Surface-water and groundwater interactions along Onion Creek, Central Texas: Gulf Coast Association of Geological Societies Transactions, v. 66, p. 261–282.
- Hunt, B. B., B.A. Smith, M.O. Gary, A.S. Broun, D.A. Wierman, J. Watson, and D.A. Johns, and, 2017, Surface-water and Groundwater Interactions in the Blanco River and Onion Creek Watersheds: Implications for the Trinity and Edwards Aquifers of Central Texas. South Texas Geological Society Bulletin, v. 57, no. 5, January 2017, p. 33-53.
- Hunt, B.B., B.A. Smith, M.O. Gary, A.S. Broun, and D.A. Wierman, 2017a, An Evolving Conceptual Model of the Middle Trinity Aquifer, Hays County, Central Texas. Geological Society of America Abstracts with Programs. Vol. 49, No. 1, South-Central Section Meeting, San Antonio, Texas, March 2017. <https://gsa.confex.com/gsa/2017SC/webprogram/Paper289474.html>
- Intera, 2018, Recalibration and Predictive Simulations of the Analytic Element Tool to Evaluate the Trinity Aquifer in Hays County, Texas. Technical Memorandum to the BSEACD. April 16, 2018. 29 p.
- Johnson, S., G. Schindel, and G. Veni, 2010, Tracing Groundwater Flowpaths in the Edwards Aquifer Recharge Zone, Panther Springs Creek Basin, Northern Bexar County, Texas. Edwards Aquifer Authority Report No. 10-01. May 2010. 118 pg. <https://www.edwardsaquifer.org/science-and-maps/research-and-scientific-reports/science-document-library>

- Lanini, Sandra Yvan Caballero, Jean-Jacques Seguin and Jean-Christophe Maréchal, 2015, ESPERE—A Multiple-Method Microsoft Excel Application for Estimating Aquifer Recharge. *Groundwater*, Volume 54, Issue 2, March/April 2016, Pages: 155–156.
- Neffendorf, B., and J. Hopkins, 2017, Summary of Groundwater Conditions in Texas: Recent (2014–2015) and Historical Water-Level Changes in the TWDB Recorder Network, Texas Water Development Board. Technical Note 17-01, August 2017. 56 p.
- Owens, L., and C. Kerans, 2010, Revisiting the Cow Creek Limestone: Facies architecture and depositional history of a greenhouse strandplain: *Gulf Coast Association of Geological Societies Transactions*, v. 60, p. 819.
- Phelps, R.M., Kerans, C., Loucks, R.G., Da Gama, R.O.B.P., Jeremiah, J., Hull, D., 2014. Oceanographic and eustatic control of carbonate platform evolution and sequence stratigraphy on the Cretaceous (Valanginian-Campanian) passive margin, northern Gulf of Mexico. *Sedimentology* 61, 461-496 p.
- Phelps, Ryan M., Charles Kerans, Rui O.B.P. Da-Gama, Jason Jeremiah, David Hull and Robert G. Loucks, 2015, Response and recovery of the Comanche carbonate platform surrounding multiple Cretaceous oceanic anoxic events, northern Gulf of Mexico, *Cretaceous Research*, **54**, (117), (2015).
- Rose, P.R., 2016, Late Cretaceous and Tertiary Burial History, Central Texas: *Gulf Coast Association of Geological Societies Journal*, v. 5, p. 141–179
- Rose, P.R., 2016a, Stratigraphy of Fredericksburg-Washita Division (Albian), Comanche-Cretaceous, Texas, Emphasizing Person and Georgetown Formations. *Lowery et al (eds) in Proceedings: Mesozoic of the Gulf Rim and Beyond: New Progress in Science and Exploration of the Gulf of Mexico Basin*, 35th Annual GCSSEPM Foundation Perkins---Rosen Research Conference, December 8- 9, Houston, Texas. p. 490-534
- Scanlon, B., A. Dutton, and M. Sophocleos, 2002, Groundwater Recharge in Texas. Texas Water Development Board Report. 62 p. + figures
<http://www.twdb.texas.gov/publications/reports/contracted_reports/doc/2000483340.pdf?d=77102.60000010021>
- Slade, Raymond, Jr., Dorsey, Michael, and Stewart, Sheree, 1986, Hydrology and Water Quality of the Edwards Aquifer Associated with Barton Springs in the Austin Area, Texas: U.S. Geological Survey Water-Resources Investigations, Report 86-4036, 117 p.
- Slattery, R.N., Furlow, A.L. and Ockerman, D.J. (2006) Hydrologic and Water-Quality Data, Honey Creek State Natural Area, Comal County, Texas, August 2001-September 2003. US Geological Survey Data Series 200.
- Smith, Brian A. and Brian B. Hunt, 2010, Flow Potential Between Stacked Karst Aquifers in Central Texas: in *Advances in Research in Karst Media*, eds. B. Andreo, F. Carrasco, J. J. Duran, and J. W. LaMoreaux, 4th International Symposium on Karst, April 26-30, 2010 Malaga, Spain, Springer, pp. 43-48.
- Smith, B.A., B.B. Hunt, 2010, A Comparison of the 1950s Drought of Record and the 2009 Drought, Barton Springs Segment of the Edwards Aquifer, Central Texas: *Gulf Coast Association of Geological Societies Transactions* V. 60, p. 611-622.
- Smith, B.A., B.B. Hunt, D.A. Wierman, and M.O. Gary, 2018, Groundwater Flow Systems of Multiple Karst Aquifers of Central Texas. In I.D. Sasowsky, M.J. Byle, and L. Land (Eds). *Proceedings of the 15th Multidisciplinary Conference on Sinkholes and the Engineering and Environmental Impacts of Karst and the 3rd Appalachian Karst Symposium*, National Cave and Karst Research Institute (NCKRI) Symposium 6, p 17-29.
- TWDB, 1960, Channel Gain and Loss Investigations Texas Streams 1918-1958. Texas Water Development Board Report. Bulletin 5807 D. 284 pg. <http://www.twdb.texas.gov/publications/reports/bulletins/doc/B5807D.pdf>

Watson, J.A., A.S. Broun, B.B. Hunt, D.A. Wierman, and B.A. Smith, 2017, Mapping the Upper Glen Rose Unit 3 Aquitard: Implications for Recharge to the Middle Trinity aquifer, Hays County, Texas. Geological Society of America Abstracts with Programs. Vol. 49, No. 1, South-Central Section Meeting, San Antonio, Texas, March 2017.

Watson, J., A.S. Broun, B.B. Hunt, B.A. Smith, D.A. Johns, J. Camp, and D.A. Wierman, 2018, Summary of Findings: Upper Onion Creek Dye Trace, Hays County, Texas, Winter 2017. Interagency Memo. May 18, 2018. 19 p. http://bseacd.org/uploads/Upper-Onion-trace-memo_05182018.pdf

Wierman, D.A., A.S. Broun, and B.B. Hunt (Eds), 2010, Hydrogeologic Atlas of the Hill Country Trinity Aquifer, Blanco, Hays, and Travis Counties, Central Texas: Prepared by the Hays-Trinity, Barton/Springs Edwards Aquifer, and Blanco Pedernales Groundwater Conservation Districts, July 2010, 17 plates +DVD.

Wierman, D.A., J. Walker, R. Fieseler, J. Watson, A. Broun, S. Haddad, and J. Schauer, 2017, How Much Water is in the Pedernales? Determining the Source of Base Flow to the Pedernales River in Northern Blanco, Hays and Travis Counties. The Meadows Center for Water and the Environment. Texas State University. September 2017. 20 p. <http://gato-docs.its.txstate.edu/jcr:7b366652-9904-4c1d-9a87-ee885a5129fe/baseflow-report-final.pdf>; <http://gato-docs.its.txstate.edu/jcr:f1c3bfe7-6d76-49ad-81ce-5e2845777b32/Appendix%20A%20-%20FINAL.pdf>

Wierman, D.A., Walker, J., Butler, W., Zapetello, S., and Warren, E., (2017) Occurrence of Flowing Water and Water Quality during Base Flow Conditions in the Pedernales River Basin, Meadows Center for Water and the Environment, Texas State University, San Marcos, TX.

Wierman, D.A., and B.B. Hunt, 2018, Groundwater Level Monitoring Results for HTGCD Transducer Wells and Wimberley Valley Public Water Supply Wells, Hays County, Central Texas. The Meadows Center for Water and the Environment, Texas State University. March 2018, 14 p.

Wong, Corinne I., Kromann, Jenna S., Hunt, Brian B., Smith, Brian A., and Banner, Jay L., 2014, Investigation of Flow Between Trinity and Edwards Aquifers (Central Texas) Using Physical and Geochemical Monitoring in Multiport Wells. Vol. 52, No. 4—Groundwater—July-August 2014 (pages 624–639).