

# GALVESTON COUNTY'S SHORE LINE FLOOD PROTECTION, RESTORATION AND IMPLEMENTATION PLAN

30 1992  
RESEARCH AND PLANNING

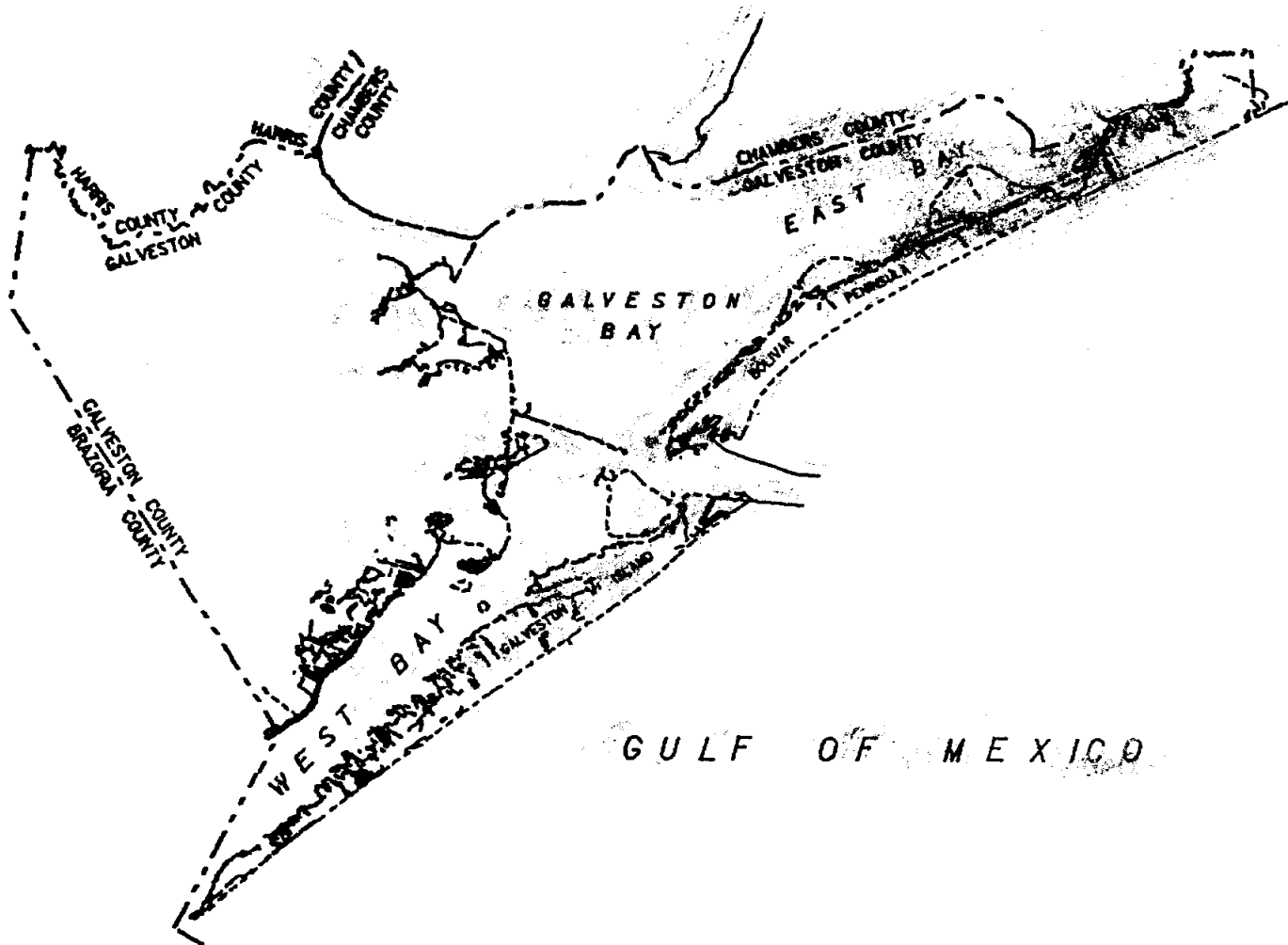

FOR  
GALVESTON COUNTY AND THE CITY OF GALVESTON  
AND THE TEXAS WATER DEVELOPMENT BOARD

DANNENBAUM ENGINEERING CORPORATION  
HOUSTON, TEXAS

TEXAS A&M UNIVERSITY GALVESTON

October 1992

**DANNENBAUM ENGINEERING CORPORATION**

3100 WEST ALABAMA HOUSTON, TEXAS 77098 P.O. BOX 22292 HOUSTON, TEXAS 77227 (713) 520-9570

October 26, 1992

Mr. Tommy Knowles  
Director of Planning  
Texas Water Development Board  
1700 North Congress Avenue  
Austin, Texas 78711

Re: Final Report of the Galveston County Shoreline Flood Protection  
Restoration and Implementation Plan - TWBB Contract No. 90-4383-771

Dear Mr. Knowles:

Submitted herewith are twelve (12) copies of the final report for the Galveston County Shoreline Flood Protection Restoration and Implementation Plan. This final report reflects comments received from the Texas Water Development Board on July 21, 1992, the Corps of Engineers, received June 19, 1992, the Texas General Land Office, received July 14, 1992, Galveston County, received July 29, September 9 and August 11, 1992 and Galveston County Beach Parks Board received August 11, 1992. We have revised the report to reflect these comments with the exception of a few which we felt had comments that asked for effort outside the scope of the contract or were not related to beach protection from storm erosion.

Attachment No. 1 to this letter describes some of the comments that we felt were not applicable to this report scope. This attachment is our explanation of those issues. We have enjoyed working with you on this report and look forward to working with you on future projects. Should you have any questions, please feel free to contact us.

Respectfully submitted,



Mike Strech, P.E.  
Division Manager

HMS/aly  
2825-01  
AYL2TK

xc: Galveston County (9 copies)  
General Land Office (1 copy)  
Corps of Engineers (1 copy)  
City of Galveston (2 copies)

## ATTACHMENT NO. 1

The grammatical and format errors in the draft have been corrected and are properly formatted and referenced to the rest of the report. We have added a summary conclusion and recommendation to the abstract. We have not tried to expand how the research can be applied to development of the coastal management plan. I believe the report describes enough of the various options for a definitive coastal management plan to be created. Our assignment was to review storm water protection issues and erosion issues. A comprehensive plan that would involve all of the issues especially the structural solutions and the building ordinances are not within the scope of this contract.

We have relisted all of the bibliographies and put them in a standard format with numbers for reference in the report. We did not put the book, Living with the Texas Shore in the report since it is available for other people to use and we did not use it as part of our report. We took most of the reports listed in the bibliography and wrote a brief summary, recommendations, and conclusions so that readers of this document will have a good understanding about previous research that had been conducted about these various subject matters.

This study was intended to indicate the types of problems, the types of solutions and some prioritization based on certain criteria. The study was not intended to be a full preliminary design with prioritization of all the areas, cost estimates of all the issues, and maintenance determination of the types of solutions.

We have listed the conditional, new, emerging shore protection technologies that were extensively discussed in the Texas A&M Report. We have moved Dr. Wang's report into the body of this report including the reference documents that Dr. Wang used with his report.

In the section concerning subsidence and sea level rise, we have corrected some of the data and referred to the Bureau of Economic Geology historical data. We have not tried to determine the impact except to point out that sea level rise is an issue even though not a major one in terms of time versus rise. Subsidence is also an issue in some parts of Galveston County from ground water withdrawal and from oil and gas production. There are more major issues facing Galveston County with respect to protection from storm events than the sea level rise or subsidence. If ordinances are setup in the future that establish building setback lines, then the sea level rise and the subsidence would need to be part of that ordinance preparation process.

We have compared 1953 and 1990 aerial photographs to determine the erosion rates. The rates shown are approximate rates per year based on these aerial photographs. Areas where the accretion is occurring and where the erosion is occurring are indicated. The accuracy of these projection is limited to the accuracy of the aerial photographic process. There were not sufficient funds in this project to determine from actual field surveys the exact of amount of erosion rate for these various areas. The computation of acreage lost from erosion is approximate based on the 1953 and 1990 aerial photography overlays. This calculation is not intended to be accurate but is intended to show a trend in those areas in the amount of acreage lost in 27 years.

The rankings of shoreline problems were established primarily based on the overall economic impact to Galveston County. The beach and recreational facilities are highly impacted from an economic standpoint and problems with structures, roads, ferry landings and the end of the seawall are also high priority because of the potential damage to structures. We have corrected the phasing tasks shown in the exhibits to accurately correspond with the phasing task described in the body of the report.

Environmental concerns are always an issue but storm water protection was the basis of this report and identifying the areas needing protection from storm water erosion. Reducing or eliminating erosion will have a positive environmental effect because the eco-systems, including marshlands, wetlands and the dune systems all add to the positive side of the environmental issues. When these are lost due to the erosion, a negative environmental impact will occur.

The closing of dune openings is a needed requirement for protecting the backshore sides of the island. It is also an economic and governmental decision about how the recreational visitors to the island can have access to the beaches without destroying the dune systems. I think Pocket Parks and parking lots behind the dune systems with "over the dune" access walkways or ramps are methods of solving this issue. Vehicular traffic through the dunes on the beach and around the dunes is quite destructive to the dune systems.

Review of the previous reports and documentation indicated that the legal issues involved with erosion protection relate to state law with respect to public beaches and local ordinances with respect to building locations. The Comprehensive Coastal Management Plan when it is prepared by the General Land Office will probably establish some recommended thirty year and sixty year building set back plans based on expected erosion rates over the next thirty to sixty years. This is common in other areas of the country where the states have established these rates and tied them to the flood insurance requirements of the federal government.

The overall implementation schedule is impossible to create until the source of funding is determined and the commitment is received from Galveston County, State of Texas, and the federal agencies related to storm water erosion protection. The cost estimates shown in the report and in the cost summary indicate that there are tremendous needs in Galveston County. An implementation plan, tied to funding, will need to be developed in the future. One of the key elements in this implementation and funding is the ability and willingness of the Corps of Engineers to replenish the beaches using their dredging operations. In a recent report the Corps was quoted as saying that the samples from the areas that they intend to dredge do not appear to have beach quality sand available. Therefore another source of beach quality sand needs to be evaluated with respect to dredging and replenishment of the beach sands. Preparation of a maintenance schedule is also impossible and out of the scope of this report because the type of correction recommended is primarily beach nourishment and very little structural facilities. Beach nourishment maintenance will depend on the erosion rate along the beach and that varies between summer and winter and from year to year.



# GALVESTON COUNTY SHORELINE FLOOD PROTECTION RESTORATION AND IMPLEMENTATION PLAN

## TABLE OF CONTENTS

<u>Section</u>	<u>Page No.</u>
I. Acknowledgment	1
II. Galveston County Beach Preservation Association Membership List	2
III. Abstract	6
Summary: Sand Resources Discussion	8
Summary of Cost Estimate	10
IV. Research Shoreline Technologies and Approaches	13
A. Prior Report's Summaries and Recommendations	14
B. Shoreline Technologies	64
C. Sea Level Rise and Subsidence	66
D. Texas A&M University -Shoreline and Implementation Options	68
V. Identify and Prioritize Problem Area in the County	69
A. County Zones	69
B. Mapping of County Shoreline Erosion from 1953 to 1990/Problem Areas	69
C. Field Survey Report	70
1. Zone 1 - Bolivar Peninsula	70
2. Zone 2 - Galveston Island	73
3. Zone 3 - Mainland	76
4. Aerial Photos	77
D. Problem Areas	77
1. Erosion Rating	77
2. Listing and Description	79
VI. Review and Identify Alternative Technologies	93
A. Alternatives Considered	94
B. Alternatives Selected	95
VII. Alternative Phasing, Cost Estimates, and Schematics	99
A. Bolivar Peninsula	99
B. Galveston Island	102
C. Mainland	104

**TABLE OF CONTENTS**  
(Cont'd)

<u>Section</u>	<u>Page No.</u>
<b>VIII. Funding Program and Options</b>	<b>106</b>
<b>A. Federal</b>	<b>107</b>
<b>B. State</b>	<b>126</b>
<b>C. Local</b>	<b>129</b>
<b>D. Private</b>	<b>131</b>
<b>APPENDICES</b>	<b>132</b>
<b>A. Bibliography</b>	
<b>B. Exhibits</b>	
1. Zone Map Potential Sand Sources	
2. Zone 1 Bolivar Peninsula	
3. Zone 2 Galveston Island	
4. Zone 1 Bolivar Peninsula	
5. Zone 2 Galveston Island	
6. Zone 3 Lower Mainland	
7. Zone 3 Upper Mainland	
8. Bolivar Peninsula Profile	
9. Galveston Island & Bolivar Peninsula Dune Protection	
10. Jetty - Rollover Pass	
11. Groin Field Profile	
12. West Beach Profile	
13. Groin Modification	
14. Roadway Termination	
15. Bay Shore Park	

I. ACKNOWLEDGMENT

The Galveston County Beach Preservation Association (GCBPA) is composed of a variety of knowledgeable individuals representing diverse interests within the County. The Association was formed in the fall of 1988 by Galveston County Commissioners Court. GCBPA's goal is to reduce shoreline erosion and enhance the environment. This planning effort would not be possible without the support of GCBPA, Galveston County Commissioners Court, the City of Galveston, and the Texas Water Development Board. The efforts of the Galveston County Beach Preservation Association are to be commended. Their action is the reason Galveston County and the State of Texas are moving closer to the approval of a Coastal Management Plan for Texas and Galveston County.

**II. GALVESTON COUNTY BEACH PRESERVATION ASSOCIATION MEMBERSHIP LIST**

<b>Paula Allen</b>	<b>Michael Catanea</b>
<b>Commissioner Eddie Barr</b>	<b>Georgeanna Deckard</b>
<b>Mr. Boch</b>	<b>J. J. Eberling, Jr.</b>
<b>E. R. Bryant</b>	<b>Daphne Everage</b>
<b>Mr. Frank Carmona</b>	<b>Dan J. Fay</b>
<b>C. C. Corbin</b>	<b>Mike Fitzgerald</b>
<b>Jacob &amp; Elizabeth Dourbon</b>	<b>Laura Friedl</b>
<b>Mr. Russell Eitel</b>	<b>Billie Barker</b>
<b>Constable Joe Faggard</b>	<b>Allen Bleigh</b>
<b>T. M. Ferris</b>	<b>Dan Bradley</b>
<b>Mr. Frank Frankovich</b>	<b>Armin Cantini</b>
<b>Jim Bateman</b>	<b>David Cindric, P.E.</b>
<b>Barbara Boos</b>	<b>David Desoroneaux</b>
<b>W. E. Eddie Burke</b>	<b>Walt Ehresman</b>
<b>Victor Carrillo</b>	<b>Wells Fagg</b>
<b>Dr. Jim Creed</b>	<b>Mr. David Feinman</b>
<b>Willis J. Duhon</b>	<b>Ed Flippo</b>
<b>Sarah Emmott</b>	<b>Roger Gilliam</b>
<b>Paul Farce</b>	<b>Steve Greenberg</b>
<b>Mr. Tom Ferris</b>	<b>Mr. Pat Hartnett</b>
<b>Mayme Frederich</b>	<b>Ms. Sandra Hoover</b>
<b>Mr. John Arrington</b>	<b>Ms. Sylvia Jackson</b>
<b>Philip Bennett</b>	<b>Mr. Jed Kenna</b>
<b>C. J. Boudreaux</b>	<b>Vic Maceo</b>
<b>Elinor S. Burrus</b>	<b>L. W. Manning</b>

Alan McNeill

Mr. Robert Morris

Obie O'Brien

Arnold Palmeri, Sr.

Peter Gregg

Bobby Hebert

Joe Huff

Commissioner Eddie Janek

Mr. John E. Kenna

Mr. Fredric Mann

Caroline Mattlou

Mr. Jim McCloy

W. D. Myers

Mike Osten

Dr. Ed Grippon

Judy Holland

Mary Lee Huffman

Eloise Jeter

Bill Lauderbach

Judy Manning

Bill McFarland

R. D. Moore

T. H. Norman

Petula Palmer

Glenna M. Pfister

Mrs. Willard Hall

Mr. Harold Holmes

Brenda Hustis

Mr. Andrew Johnson

Harry Leicht

L. W. Manning

Jane McInvale

Kevin Moran

Julia Nye

Kendall Palmer

Ruth Rabb

Mr. Raymond Reesby

Rick Rosenthal

Michael Short

Glen Smith

Mr. Dave Srader

Mr. Judson Tatum

Y. H. Wang

Jack Webb

Anne Willis

Mr. Lee Otis Zapp

Jack Williamson

Nathan Reynolds

Herman Rudenberg

Rebecca Shoup

Brett Smith

Mr. Nick Stepchinski

Jim Vratis

Keith Ware

Dottie Wells	Dudley G. Rench
Mr. Spencer Wood	Charles Alberto
Dr. Stanley J. Zimmerman	Mr. & Mrs. C. C. Crutchfield
D. C. Challie	Mr. & Mrs. Benny H. Hughes
Gordon Robinson	Mr. & Mrs. Carl Waldman
Larry Schaefer	Mr. & Mrs. C. W. Conn
Gene/Grace Smith	Mrs. Thomas Tyndale
Mr. & Mrs. James F. Stone	Dr. Jack G. McNeill
Sally Wall	Mr. & Mrs. Sam Dengler
Jerry Warren	Ralph Mizell
James Wheat	Carroll L. Lewis
Kartheryn Wood	R. M. Phillips, DDS
Pete Zummo	Joe Ramey
Doug Thompson	Mr. & Mrs. George J. Schaumburg
Capt. Gordon Robinson	Mr. & Mrs. William Wilson
Dr. Don Schattel	Mr. & Mrs. Ed Edson, III
Ms. Mary Ellen Smith	Mr. & Mrs. E. J. Cordts, Jr.
Roy Spillers	Mr. & Mrs. George E. Bryant, Jr.
Helen Stovall	U.S. Judge Joe J. Fisher
Dan Wallach	Mr. & Mrs. Will Ohmstede
Greg Waters	Jack Belton
Sheri Willey	Joe Patrick
Mr. Gary Woods	Eugene McGowan
John Hardy	Mrs. E. D. Dillon
Larry Chasteen	Mr. & Mrs. Reed Nichols
Melanie Wiggins	Mr. & Mrs. Mark Steinhagen
Diocese of Beaumont	Mr. & Mrs. Jef C. Russell

Mr. & Mrs. Edward H. Green  
Mr. Junker Spencer  
Mr. & Mrs. Ken Ruddy  
Mr. & Mrs. Dan Collie  
V. J. O'Shell  
Charles Dyer, DDS  
Dr. Tim Humble  
Mr. & Mrs. James Mc Neil  
Mr. & Mrs. T. E. Moor  
Mr. & Mrs. Ray M. Moore  
Mr. & Mrs. Thomas Sibley  
Mr. & Mrs. Don Streety  
Mr. E. G. Edson, Jr.  
Mr. & Mrs. Harold Bevil  
Mr. & Mrs. James Dishman  
Mr. & Mrs. Charles D. Foxworth  
Mr. & Mrs. Paul McGown  
Bob Witte  
Mr. Demetrios Mitromaras  
Ms. Jane Reese  
Ralph H. Sauer  
Sara Cheavens  
Mr. Jim Guidry  
Ms. Mary McKenna  
Mr. Hank Miscavits  
Mr. & Mrs. Willard J. Hall  
Mrs. Patrick T. Peyton

Mr. & Mrs. Don E. Prouty  
Ed Rismiller  
Rhonda Brown  
Ms. Quinta Wilkinson  
Mr. Peter Samuels  
Mr. Ray Addington  
David Carson  
Patricia Rostron  
Dr. & Mrs. Dan Karnick  
Mr. & Mrs. John M. Green  
Ms. Doris Curry  
Chuck Lawrence  
Lamont Meaux  
Mr. Mike Hightower  
David Zacharias  
Mr. Tom B. Livesay  
E. Harvey Steinhagen, Jr.  
Ms. Ginger Ellis  
Gary Dimurio  
William G. Parker  
Dave Sader

### III. ABSTRACT

The Galveston County Shoreline Flood Protection, Restoration and Implementation Plan is an effort to better manage and protect coastal resources within Galveston County. The intent of the plan is to identify, prioritize and plan for the reduction of shoreline erosion in the County. The planning area included all of the gulf and bay shores within Galveston County. Existing and future federal, state and local funding alternatives were explored to assist in expediting the implementation of planning recommendations. The planning effort called for the review of prior plans, reports and studies with the intent of updating and not duplicating prior data. Recommendations are intended to provide the most economically beneficial solution for each prioritized problem area with the intent of using existing state and federal programs where possible. This planning effect is intended to be a working plan which will change as Texas moves toward development of its coastal management program. Erosion predictions are intended for general planning purposes, only, and are not represented as accurate calculations.

#### Summary

The shorelines in the County were reviewed through an "on the ground" observation. Net loss trends were determined by comparison of dated aerial USGS maps. With this information, the study zones were classified by five categories:

1. High erosion rate (three to five feet per year);



2. Moderate or low erosion rate (one foot per year);
3. Restored or stable beaches with active maintenance and nourishment program;
4. Critical erosion area where development, recreational, or utility services are threatened; and
5. Noncritical erosion areas where erosion processes are not currently threatening.

In the addition to these classifications, four generalized categories of types of solutions were considered:

1. Shoreline stabilization;
2. Backshore protection;
3. Inlet stabilization; and;
4. Harbor protection.

Erosion rates were predicated from historical mapping shoreline locations. The report's predictions and historical amounts are not intended to be accurate enough to establish setback lines policies or projections. These predictions and historical amounts are given only to indicate trends and to point out critical areas as defined above. Loss of shoreline is costly to the County and has potential impact on storm protection and damage from storm events.

Sea level rise and subsidence does not appear to have significant impact along the Gulf shore but subsidence has been a major consideration on areas of the upper Galveston Bay. The Harris Galveston Coastal

Subsidence District has established a program to eliminate or minimize subsidence caused by withdrawal of ground water.

### Recommendations

The recommendations for erosions repair and prevention are numerous and very costly for Galveston County. This report has identified the problem areas, recommended types of solutions and shown some cost analysis for recommended cost repair procedures. For Galveston County to fully utilize the data described in this report, an erosion control program needs to be developed. The needs would have to be classified as to potential damage and loss of property. the plan would also need to establish 5, 10, 15, 20 year projects listing and discuss funding sources. The funding sources would need to have commitments for local share and from supporting agencies. The funding sources would be needed to help develop new and incorporate existing ordinances relating to activities that disturb the zones. Any plan would need to be updated on a regular basis considering the vast amount of issues and, have a structure for public comments, financial options and agency controls. Awareness of the scope of the problem that this report presents is only the beginning of the process required to establish a sound erosion control program that will be beneficial to Galveston County for years to come.

### SUMMARY: SAND RESOURCE DISCUSSION

The replenishment of beaches is one critical element in the costs and

plentiful to replenish the beaches. However, because of the costs related to mining and spreading the sand, the most cost effective solution is for Galveston County to work with the Corps of Engineers and develop a joint project where dredging operators are combined with a beach nourishment program. The key to using dredged material is grain size analysis. In September, 1992 the Corps of Engineers reported analysis of the Ship Channel bottom. The analysis and conclusions stated the material was too finely graded and silty for beach quality sand.

The Corps of Engineers Coastal Research Center at Fort Belvoir, Virginia produced a report in 1979 concerning sand sources. The report identified approximate quantities of usable beach grade sand in the following locations:

1. Seaward of Rollover Pass - 6.8 to 8.9 million cubic yards;
2. Seaward of seawall from the south jetty to 61st street - 27 million cubic yards;
3. Seaward of San Luis Pass - 30 million cubic yards; and
4. Off Surfside Beach - 2.7 million cubic yards.

**SUMMARY OF COST ESTIMATE**

**A. Boliver Peninsula**

**1. Beach Restoration**

a.	Phase One-High Island to Rollover Pass	\$11,125,000
b.	Phase Two-Rollover Pass to Caplen	\$ 2,800,000
c.	Phase Three-Crystal Beach	\$ 7,000,000
d.	Phase Four-Crystal Beach West	\$ 2,500,000
e.	Phase Five-Highway 87 at Fort Travis	\$ 900,000
f.	Phase Six-Jetties and Bulkhead at Rollover	\$ 6,430,000
g.	Phase Seven-Sievers Cove/Stingray Cove	Not Determined

**2. Inlet Stabilization**

a.	Phase One-Rollover Bay	Not Determined
----	------------------------	----------------

**3. Back Shore Protection**

a.	50 Dune Breaks	\$ 500,000
----	----------------	------------

**4. Dune Outfalls**

Not Determined

**5. Dune Rebuilding**

Not Determined

**B. Galveston Island**

**1. Beach Restoration**

a. Phase One-Groin Field	\$ 6,765,000
b. Phase Two-61st Street to 8 mile Road	\$ 5,500,000
c. Phase Three-Spanish Grant to Galveston Island State Park	\$ 5,100,000
d. Phase Four-Galveston Island State Park to Indian Beach	\$ 3,750,000
e. Phase Five-Sunbird Beach to Pointe San Luis	\$ 4,100,000

**2. Back Shore Protection**

a. Travel Air/Crash Basin	Not Determined
b. I-45 Feeder-Offatt Bayou	Not Determined
c. Port Industrial Boulevard	Not Determined
d. Seawolf Park Entry Road	Not Determined
e. Dune Breaks Along the Island	\$ 180,000

**3. Dune Rebuilding** Not Determined

**4. Groin Modification** \$ 2,000,000  
(each)

**5. Break Waters**

a. Galveston Seawall	\$ 975,000
b. San Luis Pass	\$ 975,000

**C. Mainland**

**1. Shore Stabilization**

- |                               |                   |
|-------------------------------|-------------------|
| <b>a. Street Terminations</b> | <b>\$ 20,000</b>  |
| <b>(Backslope Draining)</b>   | <b>(each)</b>     |
| <b>b. Bayshore Park</b>       | <b>\$ 156,250</b> |

**D. Maintenance costs are not determinable at this time because scope, timing and funding plans will help establish what types of facilities are going to be constructed. Maintenance could then be established.**

#### **IV. RESEARCH SHORELINE TECHNOLOGIES AND APPROACHES**

##### **Overview:**

Dannenbaum Engineering Corporation (DEC), in association with Texas A&M University Research Center, Galveston, reviewed conventional, new and emerging shoreline protection technologies. DEC also reviewed prior reports, studies, and papers which have been prepared for specific problem areas in Galveston County and the upper Texas coast. A summary of some of the reports, studies, and papers reviewed is attached in Section "A." The intent of Section "A" was to insure that the recommendation of the planning effort did not duplicate prior efforts. Texas A&M's report in Section "D" is an overview of existing and new emerging technologies. Attached in Section "D" is Texas A&M's finding on shoreline technologies. Dannenbaum Engineering Corporation reviewed prior and current reports on shoreline erosion in Galveston County to ensure that this planning effort was not duplicating other planning efforts.

A. Prior Reports, Summaries and Recommendations

Listed below are summaries and recommendations of some of the prior reports and studies that were obtained and reviewed to ensure that this planning effort did not duplicate prior studies. The reports were also reviewed to insure the recommendation did not conflict with state and federal coastal zone management.

The review of prior reports and studies provided tremendous insight into the problems along Galveston County's shoreline as well as insight into alternatives to correct the problem areas. This section is intended to highlight the data reviewed.

Evaluation of Existing Conditions and Possible Design Alternatives at Rollover Fish Pass, Texas (Bibliography No.2)

This report recommends the following actions:

1. The Pass itself should be rebuilt essentially as it is including the weir.
2. Use of steel of steel sheet pilings for the retaining walls will probably mean that the Pass would need to be rebuilt again in about 25 years. If it is desired to extend the life of the project, consideration could be



given to using concrete or rubble retaining walls, as discussed at the end of Section 3.2.9. Design for the rubble retaining walls alternative should include a fixed-bed hydraulic model study of the Pass with the rubble retaining walls.

3. If the pass is rebuilt with vertical walls of either steel or concrete and if the width of the channel is not changed significantly (say, no more than 10%, then a Hydraulic model study of the entire Pass would not be needed. (Also see items 2 and 4 for other recommendations concerning hydraulic model studies.)
4. If it is desired to reduce the probability of failure of the weir and to further protect the bridge abutments and piers, the scour holes at the weir should be filled with sand or rubble and the channel bed should be armored where the scour holes presently exist. If these changes are to be made, they should be studied in a fixed-bed hydraulic model of the weir and surrounding channel.
5. The south end of the pass should be modified as shown in Figure 3.2 This would involve armoring both walls which extend into the Gulf with rubble, armoring the beach and seabed near the ends of the walls removing the sheet piling

which once acted as a groin east of the pass, and filling the indentation formed between the groin and east wall of the Pass.

6. The north end of the Pass should be modified as shown in Figure 3.4 This would involve extending the retaining walls at the end of the Pass outward (to the east and west) to protect a portion of the Bay shore and armoring the bottom of the Bay near the end of the walls to prevent scour hole formation.
7. A decision must be made as to whether beach nourishment is desired.
  - a. If beach nourishment is not deemed to be warranted, no further actions are recommended.
  - b. If beach nourishment is to be considered, it is recommended that the characteristics of the dredge spoil from the Intracoastal Waterway be investigated to determine if this is a suitable source of sand for the nourishment. (The characteristics of the spoil material dredged from the Intracoastal Waterway would also help to identify the source of the material which causes excess dredging to be required in the Waterway.)

- c. If the dredge spoil is determined to be unsuitable, then consideration can be given to dredging from Rollover Bay and doing the dredging in a manner to create a settling basin in the Bay. This alternative would require careful consideration of potential environmental effects and of the additional amount and size of sediment that would be deposited in the dredge region each year.
  - d. Any sand obtained from offshore would probably be too expensive to be considered as a viable alternative.
8. In order to quantify changes to the shoreline and beach near the Pass, Beach profiles should be obtained twice a year (summer and winter conditions) for the shoreline within two miles on each side of the Pass. Interpretation of aerial photographs for greater distances from the Pass should also be done to allow comparison with changes near the Pass.
9. Sediment transport rates through the Pass are not known with any degree of certainty. If it is important to have

reliable estimate of the actual sand movement through the Pass, a comprehensive measurement program should be conducted in the Pass for a variety of tidal, wave, meteorological, and flow conditions.

10. Monitoring of flows and sediment transport rates through the pass under the present conditions and for a period after reconstruction would provide data (for example, No. 8 above) and an early indication of any unexpected changes associated with the reconstruction.

Managing Coastal Erosion (Bibliography No.3)

This document should be reviewed by both the County and City. It provides insight into the historical reasoning for various changes in the nation's coastal management program and , based on history, recommends management changes for the future. This document will play an important role in shaping federal coastal legislation in the future. This report recommends that ten times the local erosion rate be established as the set back requirement.

Preparing for Hurricanes and Coastal Flooding: A Handbook for Local Officials (Bibliography No.4)

Property damages that can be expected from hurricanes and coastal flooding are increasing year by year. In many places threat to life is increasing also. Most coastal communities are vulnerable to one or more different kinds of flooding and related hazards:

1. Frequent flooding from storm tides, inadequate storm drainage, or overflow of coastal streams;
2. Hurricane storm surge and winds, particularly if the community is located on the Gulf or Atlantic coast;
3. Storm-caused erosion of bluffs and beaches.

This handbook focuses on two of the most common of these coastal hazards: tidal flooding and hurricanes. The handbook also focuses on the Atlantic and Gulf coasts, although much of the material on coastal flooding is just as relevant to the Pacific coast.

There are measures that a community can take to help reduce damages from hurricanes flooding. Before deciding which measures are appropriate to your situation, it is essential to be aware of the nature of the problem in your community, along with the responses already undertaken and their effectiveness. A community can draw on many sources of information to obtain this information, including local, state, and federal agencies, as well as private individuals and groups.

The following are techniques that can be used to respond to the community's coastal hazards:

1. Keeping new development from hazardous areas, through regulations, acquisition of undeveloped areas, or persuasion;
2. Promoting safe construction of development that occurs in hazardous areas, through regulations or by providing technical or financial assistance.
3. Protecting natural systems, through regulations, beach nourishment, dune vegetation and maintenance, and protective structures, such as, groins and breakwaters;
4. Protecting development from coastal flooding with structures, such as, seawalls, bulkheads, and revetments;
5. Helping people leave risky areas before storms arrive through forecasting, warnings, and evacuation planning along with programs to increase public awareness of these systems and plans.
6. Acquiring developed hazardous areas and relocating recovery actions that will reduce future losses.

Recommendations:

Many factors need to be considered in deciding which of these many techniques are most suitable for your community. Most communities will choose to use several of these measures in combination for greater effectiveness. The following are considerations to keep in mind when evaluating these measures:

1. The degree of risk, or how vulnerable the community is to a particular hazard;

2. The effectiveness of a particular technique for limiting damage from hazard; for example, the capability of a protective structure to withstand hurricane forces;
3. Cost of developing and implementing techniques;
4. Public and political acceptability;
5. Current level of awareness of the hazard;
6. Legal limitations;
7. Tax impacts;
8. Availability of data needed to implement a response;
9. Administrative enforcement and maintenance capabilities;
10. Availability, or suitability, of alternatives;
11. Impacts on natural coastal features and adjacent properties.

The importance of each of these factors varies considerably, depending on the techniques that are most appropriate to the individual community's circumstances.

Coastal Management Solutions to Natural Hazards (Bibliography No.5)

This report addresses coastal hazards and the options for dealing with these hazards involving environmental, economic, and political costs, where there is little consensus on how governments should respond to coastal hazards. Coastal hazards discussed in this report were catastrophic storms, long-term erosion and threats to natural resources.

The Coastal Zone Management Act of 1972 (CZMA) was passed to encourage states to better manage the nation's coastal resources. At state level, an agency oversees implementation and administering of the program and federal funds.

The following are management options that were most widely used by states:

- a. Managing Development; risk from coastal hazards is greatly diminished when development densities are reduced;
- b. Comprehensive Policies for Erosion Control Structures; these structures have the ironic effect of accelerating erosion, either in front of the development the structure is designed to protect, or downdrift. Therefore, sound beach nourishment requires that state and local



governments limit or prohibit erosion control structures;

- c. **Beach Renourishment;** renourishment may be viable in areas where development is particularly dense, or to protect important natural or man-made features.

This report gives examples of state efforts to implement the options mentioned above.

Galveston County Shore Erosion Study and Environment Impact Statement (Bibliography No. 10)

This feasibility study to consider providing erosion control measures for the eroding Gulf and bay shorelines of Galveston County was authorized by a House Committee on Public Works and Transportation resolution adopted on October 10, 1974. A similar study of the Surfside Beach erosion problem in adjacent Brazoria County was authorized by a House Committee resolutions adopted on September 22, 1976. The combination of the Surfside study with the Galveston County Shore Erosion Study was recommended to the House Committee by DAEN-CWP-C letter dated February 4, 1976 because the two areas have overlapping basic data collection requirements.

The study area includes the Gulf of Mexico and bay shorelines of Galveston County and the Gulf beach at Surfside in Brazoria County. Galveston County is located on the upper Texas coast

and Surfside Beach is located in Brazoria County, adjacent to Galveston County. The Galveston County portion of the study area contains approximately 53 miles of Gulf shoreline and about 150 miles of bay shoreline while the Surfside portion of the study area consists of a Gulf beach approximately 2 miles long.

Field and office studies indicated that Gulf beach erosion was occurring along most of the upper Texas coast. The objectives of the study were to:

1. Determine the needs and concerns of local people relating to shoreline erosion within the study area;
2. Identify eroding shoreline areas, and determine the cause and rates of erosion;
3. Delineate those shoreline areas where potential Federal interest exists;
4. Develop and evaluate alternatives and make recommendations for solving the erosion problems.

Two types of erosion problems are encountered in the study area:

1. Bank or bluff erosion on the bay shorelines; and
2. Gulf erosion.

Both types result from the interactions of winds, waves, currents, water level changes, geologic activity (including subsidence), sediment availability, and the passage of storms. The Gulf beach erosion is the more difficult of the two, because of the difficulty in assessing the contributing degree of each of the above possible causes to the total

erosion problem as well as having to consider the effects of inlets and their control structures. The erosion on the bay shoreline is somewhat less complex in that erosion results primarily from varying levels of wind-generated wave attack on the bank or bluffs.

Alternative measures to be considered include beach nourishment; vegetation erosion control measures; and revetments, bulkheads, groins, breakwaters, and other similar structural measures. Combinations of measures will also be considered. All of these alternative measures are more thoroughly discussed in the study.

Low Cost Shore Protection ...a Guide for Engineers and Contractors (Bibliography No. 11)

The factors relating each available alternative to shoreform and shoreline use are summarized as follows:

Methods Applicable to Various Shoreforms

<u>Alternative*</u>	<u>High Bluffs</u>	<u>Low Bluffs</u>	<u>Beaches</u>	<u>Wetlands</u>
No Action	Rarely	Rarely	Rarely	Rarely
Relocation	Sometimes	Sometimes	Sometimes	Sometimes
Bulkheads	Usually	Almost Always	Sometimes	Rarely
Revetments	Sometimes	Almost Always	Almost Always	Rarely
Breakwaters	Rarely	Rarely	Almost Always	Sometimes
Groins	Almost Never	Almost Never	Almost Always	Almost Never

<u>Alternative*</u>	<u>High Bluffs</u>	<u>Low Bluffs</u>	<u>Beaches</u>	<u>Wetlands</u>
Beach Fills	Almost Never	Almost Never	Almost Always	Rarely
Vegetation	Almost Never	Almost Never	Sometimes	Almost Always
Infiltration and Drainage Controls	Almost Always	Usually	Almost Never	Almost Never
Slope Flattening	Rarely	Usually	Almost Never	Almost Never
Perched Beaches	Rarely	Rarely	Almost Always	Sometimes

\* Applicability is for the alternative used alone in the given situation. Combination devices are not included.

#### Compatibility of Alternatives With Shoreline Uses

<u>Alternative</u>	<u>Strolling</u>	<u>Bathing</u>	<u>Fishing</u>	<u>Boating</u>
No Action	Sometimes	Sometimes	Usually	Usually
Relocation	Sometimes	Sometimes	Sometimes	Sometimes
Bulkheads	Usually	Sometimes	Almost Always	Almost Always
Revetments	Usually	Sometimes	Usually	Usually
Breakwaters	Almost Always	Almost Always	Almost Always	Usually

<u>Alternative</u> Groins	<u>Strolling</u> Usually	<u>Bathing</u> Almost Always	<u>Fishing</u> Almost Always	<u>Boating</u> Usually
Beach Fills	Almost	Almost Always	Usually	Almost Always
Vegetation	Almost Never	Almost Never	Almost Always	Rarely
Infiltration and Drainage Control	Almost Always	Almost Always	Almost Always	Almost Always
Slope Flattening	Almost Always	Almost Always	Almost Always	Almost Always
Perched Beaches	Almost Always	Almost Always	Almost Always	Almost Always

If the chosen alternative involves construction of a physical shore protection device, several key problems must be resolved before an adequate structural design is completed. The first step is an evaluation of the potential water level and design wave height at the site. Other considerations include toe protection, filtering, flank protection, structure height, and various environmental factors.

Review of Report on Gulf Intracoastal Waterway, Texas, Erosion at the West End of Bolivar Peninsula (Bibliography No. 12)

This reports concludes that the erosion on the west end of Bolivar Peninsula is in a area of filled land that was built out into a water area in Bolivar Roads. Erosion of this

filled land under natural conditions would be expected and has occurred. The erosion is caused by wave wash against the land. A study of available data on shoreline surveys does not reveal a correlation between the construction of the Texas City dike or the Intracoastal Waterway bulkhead and changes in erosion on the end of the peninsula. A study of model study test of currents through Bolivar Roads shows that neither the Texas City dike nor the Intracoastal Waterway bulkhead cause any deflection of tidal currents toward the end of Bolivar Peninsula. Wash from the waves caused by vessels traversing Bolivar Roads may result in some erosion of the land, but such erosion is small and is an insignificant part of the total erosion.

The report concludes that erosion of the end of Bolivar Peninsula is caused by natural forces and is not aggravated by any of the waterway improvements in the area that have been constructed by the Federal Government and that, therefore, the Federal Government has no responsibility to undertake corrective measures.

#### Recommendations

Accordingly, this report recommended that no improvement be authorized at this time to provide for control of erosion on the west end of Bolivar Peninsula.

Texas City & Vicinity, Texas Hurricane Protection  
Reconnaissance Report on Shore Erosion Impacting Project  
Levees (Bibliography No. 13)

This report concluded that it was the intent of the planners in the per-authorization stage that the project levees should be stable during hurricanes and be free of costly maintenance. This intent was also the intent of the Congress. Policies regarding design deficiencies indicate that if a project development fails to account for natural processes, such as bank erosion, a design deficiency is indicated. The rapid erosion of the shoreline adjacent to certain reaches of the project levees represents a flaw in the Federal design. The major or dominant cause of the rapid erosion rate adjacent to the impacted reach of the hurricane-flood protection system is wind driven waves.

Recommendation

The report recommends that the lack of proper erosion protection for the reaches of levee from about station 193+75 to station 277+00 and station 301+00 to station 317+00 should be approved as a design deficiency

The report also recommends that erosion protection be provided at project cost with the Federal Government providing the engineering design and construction and contributing 65% of the cost of

installation. Local interest will provide 35% of the cost in accordance with the cost sharing requirement of Public Law 99-662. Local interest will operate and maintain the work upon completion.

Texas Coast Inlet Studies. (Bibliography No. 14)

This study, prepared by the Corps Coastal Engineering Research Center, is significant in that it addresses three inlets in Galveston County: San Luis Pass, Galveston Entry Channel, and Rollover Pass. The study identifies sand sources available for beach nourishment. It also states the Galveston entrance (including the jetties) effectively blocks any net westward transport of sediment to the beaches of Galveston Island. This is the first time the Corps has indicated that the Galveston jetties block sediment flow to Galveston beaches.

Texas Coast Regional Inventory Report (Bibliography No. 15)

This report's conclusion is that the beaches along the Texas coast are a valuable resource and receive extensive use for public recreation and enjoyment. The value of the shore area will continue to increase with the rapid development of the coastal zone. As the development increases, the erosion problem will become more acute and consequently more difficult and costly to control. For these reasons, the most efficient and economical methods of control should be employed without delay to preserve the beaches and shoreline of this state.



Coastal Mangement: Solutions to Our Nation's Coastal Problems

(Bibliography No. 19)

This report addresses the coastal zone and management of these coastal zones. The coastal zone is the dynamic area where the land meets the sea. It includes coastal waters and the adjacent shorelands; areas which strongly influence one another. It is composed of open waters, estuaries, bays, inlets, lagoons, marshes, swamps, mangroves, beaches, dunes, bluffs, and coastal uplands.

The United States has over 95,000 miles of shoreline including the Great Lakes. The shoreline ranges from the rocky cliffs of Maine to the broad Louisiana wetlands, to the rich Hawaiian coral reefs. The wide climatic range is seen in the frozen plain of Alaska and the steamy mangrove swamps of Florida. The uses of the coastal zone are as diverse as its physical forms, including: housing, recreation, wildlife habitat, resource extraction, fishing, aquaculture, transportation, energy generation, commercial development, and waste disposal.

More than half of the U.S. population resides in the coastal counties, on less than ten percent of the nation's land. The coastal counties are five times denser in population than non-coastal counties, ten times denser along the Atlantic Coast. This population continues to grow dramatically.

Commercial ports in the U.S. coastal zone number 189 and moved 1.3 billion tons of cargo in 1986 alone. Almost forty percent of the industrial facilities in the U.S. are within a drainage basin of the Great Lakes drainage basin. Wetlands currently number about 11

million acres in the coastal zone. Wetlands serve as spawning, nursery, and feeding grounds for over sixty percent of the saltwater fish and shellfish harvested annually and contribute \$17 Billion and \$13.5 Billion, respectively, to the U.S. economy. Marine aquaculture is a growing industry. In 1986, the culture of Pacific salmon, shrimp, mussels, clams and oysters totaled 52,000 tons, valued at \$89 million.

Development pressure is 3 to 4 times greater in coastal areas than in the rest of the country. Peoples' desire to be near the coast has resulted in the development of areas vulnerable to coastal storms. The Federal Flood Insurance Program, which insures structures in Flood prone areas, represents the Federal government's second greatest liability, second only to social security. As of August 1987, there were 64,000 policies under the Flood Insurance Program in coastal high hazard areas or v-zones; coverage valued at \$5.2 billion.

Coastal recreational facilities and water dependent uses, such as energy development and ports, must be sited in limited shoreline areas. Accommodation of such competing uses is important and extremely challenging. Coastal areas provide habitat for millions of waterfowl and other wildlife, including 100 threatened and endangered species.

Coastal management attempts to reduce conflict among competing land and water uses in the coastal zones while protecting fragile resources. Coastal management goes beyond traditional single-focus programs, which address only one use or resource (e.g. ports or

fisheries). Coastal management represents a comprehensive approach to managing the impacts of an activity on other uses and on a variety of coastal resources.

The Coastal Zone Management Act, P.L. 92-583, was enacted by Congress in 1972 to improve the nation's management of coastal resources, which were being irretrievably damaged or lost due to poorly planned development. Specific concerns were the loss of living marine resources and wildlife habitat, decreasing open space for public use, and shoreline erosion. Congress also recognized the need to resolve conflicts between various uses that were competing for coastal lands and waters.

States respond by developing new program policies or regulations, often with Federal funds. The Office of Ocean and Coastal Resource Management encourages states to improve their management programs through recommendations resulting from the periodic evaluation of state programs. The Coastal Zone Management Act is discussed more thoroughly in the report.

Report on Galveston Bay, Texas for the Reduction of Maintenance Dredging (Bibliography No. 22)

The intent of this study was to reduce maintenance dredging cost. A detailed study was performed on all navigation channels within the bay as well as circulation of sediments within the waterways. The recommendation of the report falls into at least one of three basic actions: 1) reduce the amount of sediment entering the bay; 2) reduce recirculation of dredged material; 3) derive the greatest

benefit from the forces of nature.

An extremely important point in the report is mentioned in paragraph 336 on page 108, which reads:

"336. Experience with the existing groin system appears to have been already sufficiently long to warrant the statement that equilibrium has been reached. Although there is available an ample supply of drift sand, the spacing of the groins equal to three times their length appears to be excessive under the conditions existing at Galveston to arrest a sufficient portion of this sand for the formation of the desired beach, and for the full protection of the toe of the seawall."

This statement is again made in paragraph 361 of pages 114 and 115. This statement is extremely important in identifying that the original design intent of the groin to provide a 300-foot wide beach for flood protection and recreation is not being achieved. This dredge report was never referred to in the 1953 report to Congress. The dredge report clearly indicates that modifications to reduce sediment flow through the south jetties and to enhance the sediment holding capabilities of the jetties would reduce dredging cost. This would appear to be justifiable reasoning for placing dredge material on the beach and enhancing the holding

capacity of the groins and providing flood protection for the toe of the seawall.

Paragraph 383 recommends work on the beach which would reduce dredging cost. The paragraph reads as follows:

"383. Work on Galveston Beach. The plan of improvement proposes some riprapping of the outer faces of the concrete caps of the groins where needed, some dumping of sand at the toe of the seawall where needed, the construction of minor structures to supplement the action of the existing groin system over a length of approximately 4.3 miles, and the protection of the dry base area in East Beach with salt cedars and sand fences. The details of this work are to be determined later, partly experimentally and partly on the basis of future inspection of results obtained elsewhere with similar methods."

Submerged Lands of Texas, Galveston-Houston Area: Sediments, Geochemistry, Benthic Macroinvertebrates, and Associated Wetlands (Bibliography No. 24)

Surface sediment textures, sediment geochemistry, and benthic fauna of the State-owned submerged lands were mapped and described using bottom samples collected at 1-mi(1.6-km) intervals from bays, estuaries, and lagoons and from the inner continental shelf. In addition, the distribution of wetlands in adjacent areas was mapped using color-infrared photographs taken in 1979.

Textural maps of the Galveston-Houston area show that mud and sandy mud, having a mean grain size of between 5 and 8 are the dominant sediment types in bay-estuary-lagoon and inner-shelf areas. Generally, muds occupy the deeper, central-bay areas of Trinity and Galveston Bays, whereas, sandier sediments occur along the bay margins. Sediment distribution patterns in East and West Bays and in the southern part of Galveston Bay are more complex. Sandy sediments are associated with flood-tidal deltas at Bolivar Roads and San Luis Pass and with the modern barrier islands. Shelly sediments are locally abundant, primarily in association with oyster reefs. On the inner shelf, sand occupies the nearshore zone along the beach and shoreface. This zone, which is extremely narrow along Bolivar Peninsula, broadens offshore from Galveston Island. Gulfward, mud and

sandy mud are widely distributed. Sandy mud occurs along much of the seaward perimeter of the study area and projects landward as "background" reentrants among other sediment types. Accurate trends of muddy sand and smaller patches of sand most likely delineate ancestral strandlines on the inner shelf. Shell represents only a minor fraction of shelf sediments. The distribution patterns of sediment types in many areas of the bays and in some areas on the inner shelf reflect different levels of wave and current energy mostly by water depth.

Gulf Shore of Galveston Island, Texas, Beach Erosion Control Study (Bibliography No.25)

This study reviews the erosion of Galveston beaches from the south jetties to Eight Mile Road. The study was initiated to determine if the south jetties were causing the erosion of Galveston's west beaches which were west of 61st Street. The study concludes that erosion in the study area was caused by natural processes. Part of the natural process includes a lowering of the Gulf bed over the whole area in front of Galveston Island from 1 to 3 feet.

This could be attributed to subsidence or sea level rise. The Beach Erosion Board found no evidence to support the opinion "that erosion of West Beach is caused by the Galveston Harbour's south jetties constructed by the United States, but concludes that the large and continuous accretion west of the

south jetties and lack of accretion east of the north jetties are presumptive evidence that the jetties have not caused erosion of West Beach." Because the study area and scope were limited, a full analysis of the entire coastal system was not performed; therefore, the recommendations reached have some unanswered questions. The study does indicate a continuous accretion on East Beach since the construction of the south jetties in the 1880's. One could conclude that the south jetties are trapping sediment which would normally be carried into the entry channel or along the coast. The south jetties in effect create a dead zone where longshore transported sediment is trapped. This zone extends from the end of the south jetties to the groin at 10th Street. Sediments carried naturally into this zone are trapped and cannot be removed by the natural process except under storm conditions. The fact that the jetties are trapping sand does create a negative impact on the west end of Galveston Island. There is, however, a positive effect on the east end. The report in paragraph 101 states, "The groins have been successful in stopping erosion along the toe of the seawall and in causing considerable fill below the water surface; however, the inner ends of the groins have not filled to capacity and the usable beach has not been built to the desired extent." "Enlargement of the beach in the groin system would require artificial replenishment of the beach material."



Report on Beach Erosion at Galveston, Texas (Bibliography No. 27)

This report justified the installation of the groin field. The design intent of the groins is indicated on page 9 of the report, paragraph 26 reads as follows:

"26. Groin Design - The height of the shore section of the groin along the beach from 12th Street west should be sufficient to impound sand at the toe of the seawall but not high enough to prevent the free passage of sand at normal berm elevation, which is approximately 5 feet.

Hence, the elevation of +4 has been selected as proper. The citizens desire a beach approximately 300 feet wide. To provide this, the length of the shore section has been fixed at 100 feet, and the sloping section has been given a slope of 1 on 66 and will extend 200 feet beyond the shore section. The top of the offshore horizontal section will be at elevation +1 and should extend for 200 feet, making the total length of the groin 500 feet. These groins should be spaced 1,500 feet apart and should be generally perpendicular to the face of the seawall to prevent flanking and to prevent scour at the toe of the wall during storms. Details of the design are on sheet 3."

Report on Beach Erosion Control Cooperative Study of the Gulf Shore  
of Bolivar Peninsula, Texas (Erosion at Rollover Fish Pass)  
(Bibliography No. 28)

This study concluded the most suitable method of shore recession control and stabilization was to construct sills at the highway bridge and Gulf end of the channel and side bulkheads through the pass, with toe protection to the bulkheads and sills, and provide for periodic nourishment of the beach southwest of the pass to alleviate erosional loss of the shore. No federal funds were recommended to be spent on the project. The Texas Game and Fish Commission submitted an application to dredge a channel from Rollover Bay to the Gulf in February, 1954. Work began on the pass in October of 1954 and was completed in February of 1955. Corrective action and additional protective works were found necessary to prevent excessive scour in the channel and erosion of adjacent shore immediately after construction began. The Corps estimated in 1958 that approximately 18,000 cubic yards of sediments lost annually could be attributed to the creation of Rollover Pass. They also estimated that 200,000 cubic yards of material were needed to stabilize the natural eroding beaches east of the Pass. Recommendations in the report were implemented by the State with the exception of beach nourishment. Accelerated erosion rates have continued around the Pass. Funds were recently appropriated to reconstruct the deteriorating bulkhead at the Pass. This work is in progress and includes a small nourishment

project on the backside of the new bulkhead along the Gulf shore. No long term beach stabilization project is currently planned. Beach erosion will continue unless a nourishment plan is implemented. Silting of the intracoastal waterway will also continue as tidal currents carry sediments across the waterway. The Corps did not address the impact of Rollover Pass on dredging costs along Intracoastal waterway at Rollover Bay. Dredging costs could be reduced if sediment flow across the waterway at Rollover Bay was reduced. The Corps is presently considering a silt trap for Rollover Bay and beneficial uses of dredge material from the intracoastal area.

Estimated Costs for the Protection of Bridge Abutments and West Galveston Beach in the Vicinity of San Luis Pass

(Bibliography No. 32)

This report discusses bridge abutments in the area between West Galveston Island and the vicinity of the San Luis pass. Several structural and non-structural alternatives were evaluated taken from a field study done by John Herbich and Robert Morton. They are as follows:

Structural Alternatives

- a. Jetty on West Galveston Island side;
- b. Jetties on both sides of the Pass;
- c. Offshore breakwaters;
- d. Seawall;

- e. Revetment;
- f. Groins; and
- g. Protection for bridge abutments.

#### Non-Structural

- a. Beach replenishment by hydraulic suction dredging from offshore sources (these alternatives are diagramed respectfully).

The recommendation for protection of bridge abutments was construction of revetments around the abutment consisting of artificial blocks (such as tetrapods, dolosse, etc.), natural rack, concrete-filled containers, or concrete mats consisting of blocks held together with plastic cables. The report discusses each revetment material mentioned above along with the cost estimate of each.

#### Coastal State Capacity for Marine Resources Management

(Bibliography No. 34)

This report discusses indicators of enhanced state capabilities in Marine affairs and prospects for an expanded state role in ocean policy.

The emphasis on existing legal frameworks established by the federal government and apparent growth in coastal state interest in offshore issues raise a key issue, namely the capacity of coastal states to deal with marine resource issues in a sustained and knowledgeable manner. In this report,

institutional capacity refers to the ability and commitment of a state to develop, staff, and sustain institutions capable of dealing with the emerging policies. The mere existences of institution does not guarantee effectiveness, continued political support, or immunity from bureaucratic obscurity. It does, however, suggest that a states ability to deal with coastal resource issues will be limited or enhanced in large measure by the kinds of institutions it can bring to bear on them.

All coastal states have included marine issues among their historical responsibilities to preserve natural resources, protect public safety, and promote trade. This report also discusses two innovative pieces of legislation, the Sea Grant College program and the Coastal Zone Management program, helped expand traditional state capabilities by creating mechanisms for improving the management of coastal resources and involving university researchers in marine issues. This report further discusses the Coastal management Act of 1972.

Also discussed is the institutional capacity and political commitment to ocean affairs varies widely among coastal states. Those states with the greatest capacity for dealing with marine issues are those with a mature set of ocean-related institutions in place, a high level of professional expertise in marine affairs within the state agencies, good working relationships between state agency

staffs and university ocean specialists, and the interest and commitment of political elites in the legislative and executive branches of government.

Since the early 1970's North Carolina has developed a set of laws, institutions, and policies directed toward its coastal and marine resources that has few peers among the coastal states.

Texas stands in sharp contrast to North Carolina in terms of institutional capability to manage its marine environment. Two examples to illustrate the point. The first is the State's failure to establish a Coastal Management Program. The second is the difficulties in dealing with Galveston Bay issues. This lack of capability is largely the result of the State's history and political culture. There is no department of natural resources or the environment. In short, Texas, though organized to deal with specific marine uses and resources, is not administratively or politically structured to deal with the kinds of issues that involve multiple uses, overlapping jurisdictions, and technical expertise.

In short, the State's current alignment of executive agencies, the absence of a legal framework for coastal management, and the apparent absence of incentives for closer interagency cooperation and collaboration make it highly unlikely that institutional arrangements for the management of coastal

and estuarine resources will emerge any time soon. Galveston Bay is a case in point. There is a large gap between the emerging consensus that Galveston Bay must be addressed as a system, and the existing institutional structure of state government for addressing Galveston Bay in this manner.

Lineations and Faults in the Texas Coastal Zone (Bibliography No.35)

This report concludes that the land surface of the Texas Coastal Zone is inscribed by faults and lineations, which are, in part, the result of the propagation of Tertiary faults through the unconsolidated Pleistocene and Recent sediments. Lineations may be passive structural features representing either surface extensions of Tertiary faults or joint patterns. Lineations are linear zones that can be several thousand feet wide.

Lineations are coincident with the surface trace of many subsurface faults that have been extrapolated to the land surface. In the Houston-Galveston area of land subsidence and active faulting, lineations are coincident with several zones of active faults. Not all active faults are coincident with lineations. Lineations are commonly coincident with zones of differential subsidence in the Houston-Galveston area. Movement on some surface faults has been accelerated by a declining piezometric surface within the coastal aquifer system. Lineations in nonsubsiding zones appear to be passive

structural features that may pass along strike into active surface faults or zones of differential subsidence in areas of land subsidence. Differential subsidence may be a precursor to active faulting because it represents a flexing of the land surface before fault rupture. Lineations and subsidence profiles are valuable tools for identifying incipient faults in many areas. Important questions arising from the data presented in this report cover subjects including the mechanisms of fault activation, the relationship of faults to hydrologic boundaries, the relationship of subsidence to phenomena other than groundwater withdrawal, the consequences of groundwater production from different sections of the Gulf Coast aquifers, and the possible effectiveness of a ground-water management program for the Houston-Galveston area.



Texas Coastal Management Plan 1990-1991 (Bibliography No.36)

The Texas Legislature recognized the many problems threatening the Texas Gulf Coast by passing Senate Bill 1571 in 1989. This legislation designated the General Land Office the lead agency in developing a comprehensive, long-term plan for state-owned coastal public lands. This is the first substantial legislation addressing coastal needs in Texas since 1973.

Texas is one of two coastal states (excepting the Great Lakes states) that do not have federally approved and financed Coastal Zone Management Plans.

This document presents the initial recommendations for the Texas Coastal Management Plan being developed under S.B. 1571.

Over a third of the state's population and economic activity is concentrated in a tenth of its land area within 100 miles of the coast. It is projected that by the year 2000, more than 5.3 million people will live in the first tier of counties bordering the Texas coast. The population living directly on the state's shoreline will have more than doubled between 1960 and 2010, according to projections by the U.S. Department of Commerce.

Three issues emerged from five public meetings that were held as being of primary importance to the coastal public: coastal erosion/dune protection, wetland loss, and beach access. This document summarizes the management recommendations developed and approved for each of these issues by the citizens who participated in the workshops and by the Coastal Management Advisory Committee.

The recommendations are as follows:

Coastal Erosion and Dune Protection

Develop coastal erosion demonstration projects to show the feasibility of different methods of slowing coastal erosion or alleviating the current deficiency in the sand budget. Manage placement of dredge material to replenish eroded areas as appropriate, establishing guidelines for stockpiling beach-quality dredged material that incorporate grain size and toxicity level standards. Increase planting of vegetation as a low-cost means of inhibiting bayshore erosion. Design a state program which can be certified under the 1988 Upton-Jones Amendment to the National Flood Insurance Act. Established development guidelines and setbacks in coastal areas based on historical rates of shoreline erosion. Support research and nursery projects to develop and cultivate disease-resistant vegetation adapted to local conditions. Seek government and private help in this effort. Require new dams, groins, and other structures which impede sand movement to be constructed with sediment bypassing systems, and, where feasible, retrofit existing structures to allow bypassing. Amend the Dune Protection Act to apply to all Texas coastal counties. Give coastal counties regulatory authority to manage beaches in unincorporated areas. Increase efforts to educate the public about the causes of erosion and the importance of barrier islands, dunes, and bays as a natural defense against storms and hurricanes. Evaluate the feasibility of bypassing sediment at dams to allow it

to reach the coast. Appoint the General Land Office as the lead state agency for coordinating erosion response planning among appropriate local, state, and federal agencies.

#### State-Owned Wetlands

Develop and adopt a State Wetland Conservation Plan for state-owned coastal lands, to be drafted by the Texas Water Commission, the General Land Office and other appropriate local, state, and federal agencies. Adopt a goal of no overall net loss of wetlands on coastal public lands and establish a policy framework for achieving that goal, with the Texas Parks and Wildlife Department responsible for monitoring and enforcement. Use a "networking" strategy to improve coordination among existing state and federal agencies with wetland permitting and protection responsibilities, perhaps employing memoranda of agreement (MOAs) and permit processing coordination. Reduce nonpoint-source pollution of Texas bays and estuaries, adopting standards developed by both state (Texas Water Commission and Department of Agriculture) and federal (Environmental Protection Agency) agencies. Provide for adequate seasonal freshwater inflows to Texas Bays and estuaries to help decrease contaminant concentrations and maintain overall estuarine productivity. Request the Texas Water Commission, the Texas Parks and Wildlife Department, and the Texas Water Development Board, in coordination with other agencies, to consider protection of wetlands as they determine the inflow requirements of each estuary. Examine the effects of boat traffic in sensitive wetlands. The Texas Parks and

Wildlife Department should coordinate a public effort to inform boaters of the sensitive nature of wetlands and proper boating procedures. The Texas Parks and Wildlife Department should conduct scientific studies to determine the effects of boat traffic in wetlands. Prepare long-range navigational dredging and disposal plans. As recommended in the 1990 Texas Outdoor Recreation Plan, encourage the Texas Legislature to require all local sponsors of navigation projects to prepare long-range dredging and disposal plans in coordination with the Corps of Engineers insuring adequate wetland protection. distribute public education materials, to be produced by the Texas General Land Office and the Texas Parks and Wildlife Department, explaining the importance of coastal wetlands.

Beach Access

Approve the proposed Texas Heritage Trust Fund for acquisition of parkland and environmentally sensitive areas, with a portion of the fund earmarked for quality beach access points. Mandate comprehensive beach access planning at the local level with state coordination. Give coastal counties the authority to design and implement comprehensive beach management plans. Require the General Land Office to act as the lead oversight agency for beach access planning. Require the General Land Office and the Attorney General's Office to develop guidelines and rules, as appropriate, to address administrative questions arising from the open Beaches Act,

with the Texas Attorney General's Office maintaining enforcement of the Open Beach Act. Promote erosion-conscious development to minimize real property loss resulting from enforcement of the Open Beaches Act. Develop appropriate guidelines so that the state of Texas can be certified to help local or private landowners secure aid under the Upton-Jones Amendment to the Federal Flood Insurance Act. Disseminate educational materials concerning the Texas Open Beaches Act and the importance of preserving Texas natural beach areas and dune systems, with the Attorney General's Office, the General Land Office, the Texas A&M Sea Grant Program, and the Texas Education Agency working together to develop and distribute the materials. Provide a uniform bilingual beach access sign, design and produced by the State Department of Highways and Public Transportation and the General Land Office, to local governments on the coast.

Shoreline Changes on Galveston Island Sabine Pass to Bolivar Roads An Analysis of Historical Changes of the Texas Gulf Shoreline (Bibliography No. 37)

This report's conclusion is that changes in position of shoreline and vegetation line will continue with landward retreat (erosion) being long-term trend. The combined influence of interrupted and decreased sediment supply, relative sea-level rise, and tropical cyclones is insurmountable except in very local areas such as river mouths. There is no evidences that suggests a long-term

reversal in any trends of the major factors. Weather modification includes seeding of hurricanes (Braham and Neil, 1958; Simpson and others, 1963), but control of intense storms is still in incipient stages of development. Furthermore, elimination of tropical storms entirely could cause a significant decrease in rainfall for the southeastern United States (Simpson, 1966).

Borings on Galveston Island (Bernard and others, 1959) indicate that sand thickness ranges from 10 to 30 feet under most of the island; thickness increases to the east. Therefore, the sand stored in the barrier island should tend to minimize erosion and keep rates relatively low.

The shoreline could be stabilized at enormous expense by a solid structure such as a seawall; however, any beach seaward of the structure would eventually be removed unless maintained artificially by sand nourishment (a costly and sometimes ineffective practice). The U.S. Army Corps of Engineers (1971a,p.33) stated that "While seawalls may protect the upland, they do not hold or protect the beach which is the greatest asset of shoreline property." Moreover, construction of a single structure can trigger a chain reaction that requires additional structures and maintenance (Inman and Brush, 1973).

Maintenance of some beaches along the Outer Banks of North Carolina has been the responsibility of the National park Service (Dolan and other, 1973). Recently the decision was made to cease maintenance because of mounting costs and the

futility of the task (New York Times, 1973).

It seems evident that eventually nature will have its way. This should be given utmost consideration when development plans are formulated. While beach-front property may demand the highest prices, it may also carry with it the highest risks.

Historical Shoreline Changes in Trinity, Galveston, West, and East Bays, Texas Gulf Coast (Bibliography No. 39)

This reports concludes that except for shoreline advances associated with spoil disposal and minor accretion adjacent to some coastal structures, human activities tend to cause or contribute to shoreline retreat. The effects of decreased sediment supplied by the Trinity River, minor relative sea-level rise, and frequent, intense storms are nearly insurmountable despite wide-spread shoreline protection (particular in Galveston and western Trinity Bay). Furthermore, there is no evidence of a long-term reversal in any of the causes of shoreline erosion. In fact, some studies, such as that by Gornitz and others (1982), have demonstrated that magnitudes and rates of shoreline recession will increase if worldwide sea-level rise maintains or exceeds a pace comparable to that in past decades. Relative sea-level changes in the Galveston Bay area, caused by ground-water withdrawal, hydrocarbon production, and regional compaction subsidence, occur in addition to global sea-level trends; thus

rates of erosion can only increase. Most unprotected shorelines in the Galveston Bay system will continue to retreat landward in response to natural erosional conditions that began before the 1800's and that have been enhanced since then by human activities.

Shoreline and Vegetation-Line Movement, Texas Gulf Coast, 1974 to 1982 (Bibliography No. 40)

This study concludes that historically, the shoreline and vegetation line along the Texas Gulf Coast have been erosional; this trend continued between 1974 and 1982 at a rate slower than that for earlier periods. Despite a slowing rate of relative sea-level rise and below-average hurricane incidence, approximately 45 percent of the shoreline of the vegetation line retreated. A net land loss of about 330 acres and a net loss of about 2,000 acres of vegetation occurred between 1974 and 1982. Rate of land loss, however, was lower between 1971 and 1982 (41 acres/yr.) than in the preceding decade (400 acres/yr.; Morton, 1977).

Landfall of Hurricane Allen near Brownsville in 1980 was the most significant influence on shoreline and vegetation-line position, causing coastwide retreat. By 1982, shorelines in many coastal areas had recovered, but recovery of eroded vegetation lines was incomplete. Consequently, average rates of retreat calculated for the 1974 to 1982 period indicated that vegetation lines were retreating faster than shorelines. The most widespread and rapid retreat of shorelines and



vegetation lines occurred on large promontories such as the Rio Grande and Brazos-Colorado fluvial-deltaic headlands, where waves eroded relatively sand-poor deposits, and longshore currents carried them away. Sediment supplied from the erosion of these headlands helped reduce rates of shoreline erosion in other zones where longshore sediments converge.

Indications of increasing rates of relative sea-level rise since 1982 coupled with passage of Hurricane Alicia in 1983 suggest that the Texas coast is again undergoing rapid rates of shoreline and vegetation-line retreat similar to those observed during the late 1960's and early 1970's. Continued reduction in sediment contribution by the Rio Grande, Brazos River, and coast by jetty construction and channel dredging; and rising sea levels will all probably contribute to increased erosion rates in the future.

Special Committee on Texas Coastline Rehabilitation  
(Bibliography No. 41)

This report recommends that the Texas Coastal Program of 1980, a comprehensive management plan encompassing activities in all of the first tier counties along the Texas coast, should be reviewed, revised, updated and resubmitted to the governor.

The General Land Office should be designated as the lead agency to develop a "networked" program involving all other agencies with responsibilities and authority on coastal

issues, including, but not limited to the Texas Parks and Wildlife Department, office of the Attorney General, Texas Water Commission, the Texas Water Development Board, and the Department of Highways and Public Transportation. Implementation of the Coastal Zone Management Program should be administratively housed with the General Land Office.

Prior to submitting the Coastal Zone Management Plan to the governor, public input should be sought and presented at public hearings to be held in coastal communities. The governor is requested to review the plan for approval, and upon approval, shall submit the plan to the U.S. Secretary of Commerce/National Oceanic and Atmospheric Administration (NOAA) with the intent of having Texas participate in the federal Coastal Zone Management Program.

A Coastal Resources Council should be created as an advisory group to the governor. A forum to assess and plan coastal management.

Preliminary Designs of Improvements at Rollover Pass and Vicinity Bolivar Peninsula, Texas (Bibliography No. 42)

This report concludes that there are both negative and positive aspects of this report and they are as follows:

The negative aspect being that there are some discrepancies in the data on the flow through the fish pass. This confusion is the result of the discrepancies in approaching estimates of flow and literally movement in the historical data. Mason

(1981) describes two instances of historical disorder in the data. The first being, tide measurements made between 1887 and 1890 were lost. The second case concerns tidal measurement between November 1956 and February 1957 with malfunctioning gages.

Though these problems seem minor given the time frame, the literature indicates that much of the other work done in this area is a sketchy patchwork of short term study. Historically, others have studied the area, as Dr. Wang has, within a narrow deadline and this must make their conclusion suspect. Since the literature and their work are serious attempts to explain the previous processes, they should not be disregarded. What is obvious is the need for more study and it is believed that further delay is not warranted but that work should commence soon, whether their plan or another. With any modification or structure changes, this will invalidate some, or all, previous work; so as work takes place, constant monitoring will be necessary. This monitoring should be such that detrimental processes that arise can be nipped in the bud, by modifying the plan used.

Dr. Wang discusses the positive aspect being that they are convinced that implementation of beach nourishment, the new and continuous duneline and widened berm, is overdue. While there may be those who have reservations on the financial expenditure, what they see is a good plan, partially completed at the outset, whose completion has been overlong delayed.

The on-going process of erosion are the result of three major influences:

1. The damming of rivers
2. Jettied ship channels and associates literally damming
3. The cutting of a fish pass that allowed a loss in the longshore sediment budget

A change can not be called for in the first two but, with this plan totally implemented, the impact of number three can be reduced. The hydraulic factors analysis generated the wave and current data needed to define the ROP erosion process and the condition in which their jetties must work. The data was then incorporated in the structural design helping to derive the jetty lengths and material sizes. The jetties, as designed, should stop most of the sediment loss into the bay and withstand the forces developed by a 100 year storm.

This report recommends that further study and construction begin as soon as possible. Delay will only worsen the situation. In the short term, property will be lost and marine populations in Texas Coastal waters will continue to decline. While we can put a short term price tag on the first, delay for the second could result in declines from which marine populations may never fully recover.

Beach Erosion in South Carolina (Bibliography No. 45)

This publication offers several general management concepts which included better utilization of existing coastal sand resources to protect and enhance both developed and undeveloped existing shores in a natural manner. Hard structures are only recommended after it is determined that no other systems will work. This management approach should be strongly considered for Galveston County.

Save Florida's Beaches: A Resource Protection Initiative  
(Bibliography No.50)

This report addressed the appointment of a 14 member Task Force for the purpose of recommending possible stable funding source for the preparation and implementation of Florida's Comprehensive Beach Management Plan. Florida's beaches are in trouble. Some 217 miles of beachfront are in a state of critical erosion and the relatively few remaining areas of pristine beaches are rapidly disappearing and being developed. There are not enough beaches to meet the needs of Florida's tourist and residents. Time is fast running out for this precious and economic resource. The good news is that these problems can be solved. Scientists estimate that 80% of beach erosion in Florida is man-made. It is caused by sand loss at navigation inlets. Such erosion problems can be corrected at a relatively small cost. This report states that

it is not too late to acquire large tracts of remaining pristine beach, or to acquire new public beaches accessible to population centers. In this way, natural beaches can be preserved and recreational beaches better utilized.

The Task Force agreed that any payment must come from those who benefit, both environmentally and economically, from healthy beach system.

The following benefits were identified:

1. A "Quality of Life Benefit" that accrues to all Florida residents akin to that provided by clean air, clean water, and moderate climate. Sunshine, water and beaches are valued and recognized part of Florida life and a loss of any of them would diminish the value of living here.
2. A "Recreational Benefit" that provides Florida residents with the opportunity to directly experience and use beaches for recreation and enjoyment.
3. An "Economic Benefit" for Florida residents and businesses who benefit from the enormous economic impact of beaches to state and local economies.

Tourism alone provides: 1. \$8 billion in annual beach related sales, 2. \$500 million in beach-related state sales tax collections, 3. 320,000 beach-related jobs with a payroll of \$1.9 billion. Other beach related activities, including development, add to this total. As

contrasted with many other natural resources, beaches have the capability of paying their own way.

Coast In Crisis (Bibliography No.51)

This report addresses how the ever changing character of coasts makes them hazardous for people, and long term for buildings and structures. Population growth continues to accelerate along our Nation's coastline. This population explosion superimposed on the dynamic forces acting on coasts is leading to a coastal crisis marked by the following concerns:

1. Coastal erosion at widely varying rates affects all 30 coastal states and all of the U.S. Island Territories.
2. During the past 200 years, more than half of our valuable wetlands have been lost due to a combination of natural processes and human intervention.
3. Pollution of coastal areas has forced the closing of one-third of the Nation's shellfish beds, has restricted beach use, and has permanently contaminated ground water in some communities.
4. In many coastal urban areas, hard-mineral resources such as sand and gravel for construction and beach nourishment are no longer available onshore. Offshore deposits may provide an alternative but pose environmental and

economic dilemmas.

The crisis in the coastal zone is worldwide but is especially alarming in the United States, where an expanding and more affluent population combined with a variety of government subsidies over the past 50 years have enabled widespread and often unwise development to take place. If present demographic trends of population growth and expanded development continue, and if sea-level rise brought on by potential climate changes also occurs, stress on our coastal environments will increase substantially. Ignorance and continued disregard of the geologic processes that constantly reshape our coasts are tragically intensifying the collision between people and nature.

Coordinated multidisciplinary efforts are needed to improve our understanding of how coasts form and evolve. Many different scientific disciplines must be involved. Many different scientific groups can provide critical expertise in specific fields of research. Cooperation among Federal, State, and local agencies will ensure that this scientific expertise is applied in site-specific studies to solve the individual problems that make up the coastal crisis efforts focused on understanding our coast require efficient coordination to get maximum return from the limited resources available.

Some engineering practices and human activities that are incompatible with natural processes and that cause long-term harm to the coast can be modified to lessen their effect. In



other cases, erosion mitigation techniques that closely replicate natural processes, such as beach nourishment, sand dune creation, and shoreline restoration , can be used to provide temporary protection. In extreme circumstances, abandonment and relocation of communities might be the best alternative.

Dealing effectively with the present coastal crisis and resolving future conflicts along our coast will require a combination of solutions that must be based on long-term societal needs and on sound scientific and technical knowledge, rather than emotional responses to short-term desires. Result of scientific investigations must be clearly communicated to coastal planners, engineers, and managers and, most important, to political decision-makers and the public. Only when these diverse groups understands the range of choices, and the cost (social, financial, and environmental) and risks associated with each choice, can prudent and enlightened decisions be made.

Research and field investigations by the U.S. Geological Survey and other groups over the past few decades have enhanced our understanding of the process affecting the coasts, but many uncertainties remain. The earth-science community, (the USGS and other Federal and State agencies, departments of academic institutions, and private research organizations) is beginning to address many aspects of coastal evolution. Through focused and concerted efforts, earth scientists will be able to provide decision makers and the

public with the information and interpretations they need in order to plan wisely for the future of our coast.

**Bureau of Economic Geology Reports & Studies**

The Bureau has performed numerous studies along the Texas Coast and in Galveston County. These studies provide a good base for planning. Sand sources are identified, and historical sediment movements are indicated. Beach and shoreline vegetation changes resulting from storm impact has been documented. This data is extremely valuable in the development of a resource management program to reduce storm damage. These reports should be reviewed by the City and County and additional continued monitoring of the shores should be encouraged by the Bureau.

**B. Shoreline Technologies**

1. Texas A&M at Galveston acted as a technical subcontractor to DEC. A&M reviewed shoreline technologies and prepared the technical report titled Shoreline Protection and Implementation Options for Galveston County, Texas found on Page 68.
2. The review of prior Congressional reports and dredge reports by the Corps of Engineers implied that the full design intent of the groin field was not being performed by the system installed. DEC requested Texas A&M to review the spacing of the groin field to determine if the original desired beach

could be achieved. The groin field report prepared by Professor Dr. Y. H. Wang, P.E. of Texas A&M University found in the above referenced technical report that is on Page 68.

### Summary

The discussed methods of protecting the shoreline all have their merits and limitations. The engineer-planner can choose one single method or a combination of several methods for an intended project, depending on the primary purpose of the project, the degree of protection required, the acceptable "side effects" or environmental impact, and the preference of the individual. In the final analysis, economic justification will play an important role in the decision making process of the method to be chosen.

The problem areas on the shoreline of Galveston County are identified. Analyses of the problem areas are done in the light of the physical environment and literally characteristics of Galveston coast line. Optional methods for protecting the shoreline in each problem area are suggested. The selection process for a protection method in a problem area begins with the economic analysis. The final decision should be weighed with technical merit, environmental concerns and economical soundness.

This report has been updated to include the newest methods in shoreline protection. The main categories are: shoreline stabilization, backshore protection, inlet stabilization and harbor protection. There are structural and non-structural methods of

protection. The chart titled "Classification of Coastal Engineering Problems (Page 94) indicates the various protection methods and considerations.

C. Sea Level Rise and Subsidence

While the measuring and modeling of sea level rise and subsidence were beyond the scope of this planning effort, the results of national and state studies should be noted and considered in this planning effort. A statistical analysis of global tide gauge records conducted by Gornitz and Lebedeff (1987) indicated the static rise in sea level is about 1.2 mm/year. Their analysis attributes sea level rise to thermal expansion of the upper ocean and melting of mountain glaciers. Any rise in sea level causes potential erosion problems to the beach/dune system.

Texas coastal areas have recorded a relative rise in sea level of as much as 12 mm/year (a little less than 0.5 inches/year). The Bureau of Economic Geology report for Tide Gauge on Pier No. 21 indicates a 6.3 inch rise in sea level during the 1908-1988 period. Some subsidence is experienced because of large volumes of fluids are extracted from subsurface areas. Land loss to subsidence in the Houston-Galveston area is largely attributed to long term groundwater withdrawal from shallow aquifers. Conversion from groundwater to surface water by cities, districts, authorities, and large water consumers within Harris and Galveston County is responsible for the stabilization of subsidence within these counties. This Stabilization is the result of regulation

established by the Harris-Galveston Subsidence District. Subsidence induced around large, mature oil and gas fields is locally concentrated along linear lines coinciding with the down thrust side of faults.

Fluid extraction causes an apparent decline in pore pressure within the reservoirs and alters the state of stress near the faults. Because of the slope of the fault plain and its intersection with the land surface, reductions in land elevation commonly occur more than a mile away from the producing wells rather than directly above the reservoir. Relatively little is known about the severity of land loss caused by induced subsidence and the relationship of land loss to production history, fluid composition, local geology, and near-surface conditions prior to hydrocarbon or groundwater production. Coastal plain subsidence can manifest itself as land loss in two ways. The most easily recognized responses are direct losses caused by sinking of the land surface and subsequent permanent flooding that expands marine and intracoastal water bodies at the expense of upland and wetland resources. The second type of response is accelerated coastal erosion caused by lower elevations and thus greater inland penetration of storm waves and overwash.

#### IV. Research Shoreline Technologies and Appendices

##### D. Texas A&M University's shoreline Protection and Implementation Options for Galveston County, Texas.

###### Attached Reports

1. Galveston Shoreline Restoration and Expansion, Undercurrent Stabilization Anchor Systems (Bibliography No. 33)
2. Sailfish Point (Stuart) Florida: First Demonstration of the Dewatering Approach to Beach Stabilization-Stabeach System and Comments on Stabeach System by Dr. Y.H. Wang (Bibliography No. 49)
3. Technique for Shoreline Erosion Control - The Mac-Blox System (Bibliography No. 47)
4. An Introduction to Horizontal Dewatering System, Inc. and Beach Preservation (Bibliography No. 45)
5. The Use of Viscous Drag Mats to Prevent Shoreline Erosion (Bibliography No. 44)
6. Shoreline Erosion Seminar Quantitative Analysis and Design Aspects of Shoreline Protection in Galveston County, Texas (Bibliography No. 43)

A Final Technical Report  
on  
SHORELINE PROTECTION AND IMPLEMENTATION OPTIONS  
for  
GALVESTON COUNTY, TEXAS

submitted to  
DANNENBAUM ENGINEERING CORPORATION

prepared by  
DR. Y. H. Wang, P.E.  
College of Geosciences and Maritime Studies  
Texas A&M University  
P.O. Box 1675, Galveston, Texas 77553

January 1992

**A Final Technical Report**  
**on**  
**SHORELINE PROTECTION AND IMPLEMENTATION OPTIONS**  
**for**  
**GALVESTON COUNTY, TEXAS**

**submitted to**  
**DANNENBAUM ENGINEERING CORPORATION**

**prepared by**  
**DR. Y. H. Wang, P.E.**  
**College of Geosciences and Maritime Studies**  
**Texas A&M University**  
**P.O. Box 1675, Galveston, Texas 77553**

**January 1992**



## ACKNOWLEDGEMENTS

The financial supports provided by the Texas Water Development Board (TWDB) and Galveston County through Dannenbaum Engineering Corporation are gratefully acknowledged.

The project is coordinated by Mr. Frank Frankovich, Dannenbaum Engineering Corporation. His understanding and insight into the project have engineered the final report to its present form. He has been a very pleasant project coordinator to work with.

Students in two (2) Ocean Engineering 400 classes have contributed their time and energy to work on subject matters related to this project. Their effort and dedication is hereby acknowledged.

Special thanks to Mr. Ronnie G. Barcak, a senior engineering student at TAMUG, who has devoted the summer of 1991 working on the project. His work included reading, editing, and typing of the manuscript, along with producing the engineering drawings found in this final report. His participation and dedication on this project is especially acknowledged and appreciated.

## FOREWORD

The interpretation of shoreline protection varies with individual profession and background. To the recreational beachgoer, it is the restoration of eroded beach, to the harbor officers it is the maintenance of navigation channels and the calmness of water for un-interrupted loading/unloading of goods, to the naturalist it is wildlife and endangered species, to the coastal property owner it is flooding and loss of valuable coastal land during a storm. Solution to shoreline protection varies widely depending on the nature of the problems, the locality, and the degree of protection. The complex nature of the erosion problem has made the adoption of a solution difficult in the sense that there are multiple solutions to a single problem and a good solution for one purpose may be undesirable and/or unacceptable for another. For example, the Galveston Seawall serves well for the protection of the city from hurricanes, but the beaches in front of seawall have been disappearing. The jetties at the Galveston Bay entrance served to maintain the depth of the Houston Ship Channel, but they also have created a great offset between Galveston Island and Bolivar Peninsula. Taking beach sand away artificially and/or by natural causes results in erosion in certain areas of coastline, while on the other hand, projects of beach nourishment add enormous sand volume into the littoral system. This can create problems equal to removing sand from the littoral system.

The technology of providing protection to the shoreline is multi-faceted with numerous solutions to a single problem, and conflicting demands and goals for problem solving. With this in mind, the scope of this report cannot possibly include all aspects of shoreline protection, but rather, concentrates on established technologies in practice and illuminates the new and emerging technologies presently under testing for the protection of the shoreline with special reference to Galveston County.

This final project report combines the four (4) progress reports previously submitted to DEC. New information and references considered to be relevant to this project are derived from the conferences of Coastal Sediment '91 and Coastal Zone '91 and subsequently added to the final project report.

## TABLE OF CONTENTS

Letter of transmittal

ACKNOWLEDGEMENT

FOREWORD

CHAPTER 1. Authorization and Scope.....6

CHAPTER 2. A Review of Current, New and Emerging Technologies  
for Shoreline Protection.....7

CHAPTER 3. Identification and Analysis of Shoreline Problems and  
Suggestions for Shoreline protection Options for  
Galveston County, Texas.....35

CHAPTER 4. Modification and Layout of Galveston Groin Field....62

CHAPTER 5. Concluding Remarks & Recommendation for Future Work..73

Appendixes.....75

A. Holmberg Technologies and Comments by Wang

B. Stabeach System and Comments by Wang

C. Mac-Blox, An Energy Absorbing Revetment

D. Horizontal Dewatering System

E. A Viscous Drag System

F. A Report on Preliminary Designs of Improvements at  
Rollover Pass and Vicinity, Bolivar Peninsula, Texas

G. Proceedings, Shoreline Erosion Seminar, Quantitative  
Analysis and Design Aspects of Shoreline Protection in  
Galveston County, Texas

## CHAPTER 1. AUTHORIZATION AND SCOPE

### SECTION 1.1. AUTHORIZATION

The following is a final technical report authorized by the Dannenbaum Engineering Corporation (DEC) through the Texas Water Development Board Contract No. 90-483-771 and Galveston County/DEC subcontract No. RF-90-1142-6737

### SECTION 1.2. SCOPE

This technical report starts with a comprehensive review of current, new and emerging technologies for shoreline protection. Followed the review, identification and analysis of the shoreline problems in Galveston County, Texas are performed and shoreline protection options for problem areas are recommended.

The presentation of conventional current technology for shoreline protection along with the planning and design considerations are based primarily on the practices of US Army Corps of Engineers. These methods and technology are found in the Shore Protection Manual, technical reports, and design memoranda published by the US Army Corps of Engineers.

The new and emerging technologies are derived from the testing/research/demonstration projects currently in progress and from the regional, national and international conferences recently being held in the United States. Several new and innovative methods by the author himself are also introduced herein this final report.

Location and characteristics of the problem areas along the Gulf of Mexico shoreline and the shoreline of Galveston Bay are identified and analyzed. A variety of protection options for each problem area are recommended.

Final concluding remarks and recommendations for further work are suggested.

CHAPTER 2

A REVIEW OF  
CURRENT, NEW AND EMERGING TECHNOLOGIES  
FOR  
SHORELINE PROTECTION

## TABLE OF CONTENTS FOR CHAPTER 2

SECTION 2.1.	Introduction.....	9
SECTION 2.2.	Current Trends.....	9
SECTION 2.3.	Classification of Shoreline Protection Methods....	10
	A. Hard Structures	
	B. Soft Structures	
	C. Non-structure Measures	
SECTION 2.4.	Planning and Design Considerations of Established..	11
	Shoreline Protection Practices	
	A. Structures Parallel to the Shoreline	
	B. Structures Perpendicular to the Shoreline	
	C. Beach Nourishment	
	D. Detached Offshore Breakwater	
	E. Sand Fence and Vegetation	
SECTION 2.5.	New and Emerging Shoreline Protection Technologies.	22
	A. Nature-Assisted Dune Restoration - NADR	
	B. Submerged Groin system	
	C. Beach Drain System	
	D. Mac-Blox, An energy absorbing revetment	
	E. A Viscous Drag System	
	F. Littoral Drift Manipulation	
	G. Dredged Material Placement	
	H. Beach Profile Manipulation	
SECTION 2.6.	Future Trends.....	31
SECTION 2.7.	Conclusions.....	31
REFERENCES.....		32
APPENDIX.....		75
	A Holmberg Technologies and comments by Wang	
	B Stabeach System and comments by Wang	
	C Mac-Blox, An energy absorbing revetment	
	D Horizontal Dewatering System	
	E A Viscous Drag System	

## SECTION 2.1. INTRODUCTION

The technologies available for shoreline protection are extensive and enormous in volume and thus beyond the scope of this report. There are entire libraries dedicated to coastal engineering and sciences. However, a good report of various shoreline protection methods can be found in the recent edition of the Shore Protection Manual published by the Coastal Engineering Research Center [1]. This report focuses on the planning and design aspects of the established shoreline protection practices and elaborate on the possible effects on the adjacent shoreline and environment when these shoreline protection methods are adopted for use.

This report also gives reviews on new and emerging technologies for shoreline protection. Information and testing results available in the international conferences of Coastal Sediments '91 and Coastal Zone '91 are included. Some new and innovative methods such the duneline restoration technique and modification of Galveston Groin Field by the author are offered and elaborated in this final report.

Information presented here-in will be general enough not to infringe upon freedom of choice of design engineers as to which method(s) may be chosen. At the same time, there is sufficient information for an engineer to acquire design details, once the method(s) is chosen.

## SECTION 2.2. CURRENT TRENDS

Coastal structures built decades ago for maintaining ship channels and protecting uplands have shown their effects on adjacent shoreline. Public environmental awareness has steadily increased over the past decade. This has precipitated a preference among scientists and engineers for a soft approach rather than building structures for coastline protection.

There is a reduced role by the federal government in covering the cost of shoreline protection. Local and state governments are assuming more of the financial share as well as the planning and management of their coastal affairs. This has stimulated growth of a new breed of service industry. Many innovative ideas have been funded and tested out in the field. This trend is expected to continue in the future.

## SECTION 2.3. CLASSIFICATION OF SHORELINE PROTECTION METHODS

### 2.3.A. HARD STRUCTURES

2.3.A.1. Structures parallel to the shoreline: Seawalls, revetments, bulkheads, and vertical pilings are the conventional coastal structures employed for the protection of upland from flooding and land losses. A good comprehensive review of these structures may be found in Section 2.4.A. of this report. The detached offshore breakwater for beach erosion control are the newest versions parallel to the shoreline, discussed in Section 2.4.D. A survey on the installations of detached offshore breakwaters worldwide may be found in reference [7].

2.3.A.2. Structures perpendicular to the shoreline: Jetties, groins and shore-connected breakwaters are the conventional coastal structures. The planning guideline and design criteria of this type structure are given in Section 2.4.B. The weir-jetty, weir-groin, and T-groin are variations from the conventional. The emerging technology for this type of structure is the submerged groin field, with reduced spacing between elements, such as in the Holmberg Technologies and will be discussed in Section 2.5.B.

### 2.3.B. SOFT STRUCTURES

Materials added to the littoral system: Beach nourishment by dredging offshore or trucking-in from inland are typical examples of soft structures. The planning and design aspects and the environmental impact of beach nourishment may be found in Section 2.4.C.

- \* Manipulation of the material within the system: Beach scraping and shaping of submerged bottom profiles with the help of geotechnical cloths are the newest schemes proposed and/or tested in this country and abroad. These emerging technologies are reported in Section 2.5.A., 2.5.E., and 2.5.H. of this report.
- \* Nearshore dumping: Good quality sand from dredging is dumped in shallow coastal water to form an offshore submerged berm. It is hoped that the cross-shore transport process will move the sand onto the beach. Preliminary field test results are reported in Section 2.5.G. of this report.
- \* Sand fencing: Sand fences and vegetation have been effectively used to catch wind blown sand for building dunelines. Section 2.4.E. will discuss recent studies on this shore protection scheme.



- \* Damping of wave energy: Floating, suspended devices in water to damp the wave energy or to trip the wave to break before it reaches the beach, along with artificial sea grass are examples of soft structures.

### 2.3.C. NON-STRUCTURE MEASURES

City and state ordinances have been utilized effectively to reduce manmade shoreline erosion. Lowering the coastal ground water table in an effort to encourage sand deposit on the beach through percolation is an innovative idea without employing structure. The pros and cons will be discussed in Section 2.5.C.

Letting nature take her own course is another way of handling the shoreline problem. However, in many locales, retreat is not feasible.

## SECTION 2.4. PLANNING & DESIGN CONSIDERATIONS

### 2.4.A. STRUCTURES PARALLEL TO THE SHORELINE

Seawalls, revetments, bulkheads, seadikes, and breakwaters are common structures along the shoreline. All such structures are here referred to as "seawalls". The engineering design of these structures is similar to the design of retaining walls on land; however, the planning and design considerations are different. The major differences comprise of the structure's effect on the adjacent shoreline, which will be outlined in the following [1].

2.4.A.1. Planning and design considerations: The one feature in common to all types of seawall is that they separate land and water areas. Their primary function is to maintain existing fixed land boundaries. Protection of land includes only that directly behind the structure, adjacent areas are not protected. To maintain a beach in the vicinity of these structures requires companion works. The following are design considerations that should be considered for implementation of a seawall.

- \* Shape of Seawall: There are a variety of seawall shapes, namely, vertical, sloping, convex-curved, concave-curved, and stepped. The selection of shape is determined by the usage of the structure since the shapes have differing characteristics.
- \* Location: The location of the structure is where the shoreline recession must be stopped. Location is a key element for protection from erosion which will be discussed later.

- \* **Length of Seawall:** The length of the structure should include the length of protection needed for the upland in addition to end structures to prevent flanking.
- \* **Height of Seawall:** The structure height is determined by wave runup and overtopping calculations.
- \* **Ground Elevation:** The ground elevation changes within the structure's design life is based on the local erosion/accretion rate calculations.

Other planning and design considerations are depth of wall penetration, stability against saturated soil pressures, exposure to wave action, and availability of materials.

2.4.A.2. Seawall and beach interaction: Critical reviews of the state of knowledge on the effects of seawalls on the beach may be found in reference [2]. Highlights of these reviews are presented in the following paragraphs.

- \* **Location:** A seawall's impact on the beach is largely dependent on its location on the nearshore profile. The further seaward they are constructed, the greater their influence and the less likely will a usable beach be maintained in front of the structure. A study of a 300 km seawall along the Indian Ocean led Baba and Thompson [4] to recommend fronting the wall with a wide buffer beach which attacking storm waves could act on. This is one recommendation that is in line with the beach nourishment proposal for the Galveston Seawall.
- \* **Beach Profile:** One effect of a seawall on beaches is the cause of a greater lowering of beach profile than would occur if no seawall were present. The shape of the beach profile along a seawall-backed beach remains stable and tends to be in equilibrium with the coarser grain sizes comprising the beach sediment.
- \* **Erosion:** Beaches with and without seawalls suffer similar offshore sediment transport under erosive storm waves. The scour occurring in relation to a seawall is localized near the toe of the structure. The maximum scour depth is shown to be approximately equal to the wave height in deep water. Some quantitative results regarding the erosion rates at the end of a seawall is presented in reference [3]. The depth of erosion at the end of a seawall could amount to 10% of the wall length. The along shore erosion could be 70% of the wall length.

Taking into account these planning and design considerations should provide an adequate review process for implementation of a structure parallel to the shoreline.

#### 2.4.B. STRUCTURES PERPENDICULAR TO THE SHORELINE

Groins, jetties, and shore-connected breakwaters are structures placed perpendicular or nearly perpendicular to the shoreline. However, they differ in dimension, length, and function. The groin system is singled out for discussion which follows.

2.4.B.1. Planning and design considerations: For functional planning and design, the designer must consider the following.

- \* **Groin Height:** The structure may consist of two horizontal end sections at high/low elevations. These two sections are connected with a sloping middle segment. It may also be a single narrow sloping structure on a shallow coast. The height of landward end is usually the elevation of maximum high water, plus the height of normal wave uprush. The height of seaward end is determined by the economy of construction and public safety.
- \* **Beach Alignment:** When a groin is placed on the beach, the longshore drift builds up on the updrift side of the groin, thereby creating a fillet. The down drift side is deprived of this sediment and usually erodes. The designer must then determine the eventual beach alignment or the orientation of the shoreline near the groin. There are three aspects that need to be considered; the updrift and downdrift shoreline, the shoreline between the groins, and the beach alignment for reversing direction of longshore transport. The use of groins with gradually reduced lengths, transitional groins, helps ease out abrupt changes in shoreline alignment.
- \* **Groin Length:** The shoreward end of the groin should be positioned to prevent flanking. The seaward end position should be determined by the amount of longshore transport to be intercepted.
- \* **Spacing of Groins:** The spacing between groins should be 2 to 3 times the groin length from the berm crest to the seaward end.

2.4.B.2. Interaction of Groin and Coastal Processes: The six rules describing the interaction of groins and coastal processes by the U.S. Army Corps of Engineers are given below.

- \* Rule 1. Groins can only be used to interrupt longshore transport.
- \* Rule 2. The beach adjustment near groins will depend on the magnitude and direction of the longshore transport.
- \* Rule 3. The groin induced accumulation of longshore drift on the foreshore will modify the beach profile and currents along the sides of groins.
- \* Rule 4. Water pushed by waves into a groin compartment will sometimes return offshore in the form of rip currents along the sides of groins.
- \* Rule 5. The percentage of the longshore transport which bypass a groin will depend on groin dimensions, water levels, and wave climate.
- \* Rule 6. The longshore drift that is collected in the updrift fillet is prevented from reaching the downdrift area, where the sand balance is upset.

These rules are helpful to the engineer for both planning and design purposes.

#### 2.4.C. BEACH NOURISHMENT

Beach effectively dissipates wave energy therefore is considered the first line of defense from storm erosion. Maintaining proper beach dimensions is deemed good shoreline stabilization practice. An eroded beach may be restored to a healthy one, width and slope, by adding new sand. Sand may be borrowed from an offshore source, inlet bay area, and/or land source. Economics is the major factor in determining sources. The planning and design considerations along with possible environmental factors follows.

2.4.C.1. Planning and design considerations: A general guideline for planning and design of a beach nourishment project is found in reference [1]. A brief summary is extracted which follows.

- \* Longshore transport characteristics: The longshore transport characteristics may be described by (1) longshore transport rate, (2) predominant direction of longshore transport, (3) deficiency of material supply, and (4) survey data before and after project construction.

- \* **Composition of native sand:** Sand samples should be collected and analyzed during summer and winter seasons on the beach face and offshore bottom in a depth where littoral sand moves. These native sand samples are then compared with potential sediments to determine suitability. The sample analysis should include sand size, composition, shape, specific gravity, and fall velocity. If time and funds allow, samples should be taken for analysis on the distribution variations of these characteristics at different positions within the project site.
- \* **Selection of borrowed material:** The textural pattern of native sand is the direct response of sand sorting by natural processes. Therefore, the "native composite" is used to evaluate the suitability of potential borrowed sand. Material finer than native sediment will move to a depth compatible with its size forming a nearshore slope flatter than the existing slope. Material coarser than native sediment tends to remain on the foreshore forming a steeper beach slope. Angularity and mineral content of borrowed material may also be factors in the redistribution of the placement.
- \* **Overfill factor:** If complete compatibility between native beach sand and borrowed material is not achievable, an overfill quantity is used to mediate the difference. The overfill factor is a function of grain size distribution and sorting characteristics of native and borrowed materials. A quantitative basis through an empirical formula is available for estimating the number of cubic meters of fill material required per cubic meter of native beach sand. With project dimensions known, the required volume of borrowed material can be determined.
- \* **Renourishment factor:** All beach nourishment projects need periodic replenishment. The question to be asked is how often replenishment or renourishment will be required. The borrowed material characteristics especially its textural differences from native beach sand is a major factor. Coarser sand will pass more slowly through the littoral system than finer grains. Different sand sizes will have differing residence times. To determine the periodic renourishment required, a ratio of the erosion of borrowed material to native beach sand (renourishment factor) is employed. This factor is a function of grain size distribution and sorting characteristics of borrowed and native materials, however, they are not mathematically related to one another.

- \* **Berm elevation:** The optimum berm height is preferably slightly above the storm berm. Higher elevation would require a larger volume of sand to fill the layer above the storm berm. Lower elevation than the storm berm, a ridge will form along the crest and high water will overtop, causing ponding of the backshore area. There are two ways to estimate the storm berm elevation at the project site; measurement of the actual storm berm height at nearby beach and using wave runup calculations (if available).
  
- \* **Beach slope:** There are two types of beach slopes to be considered; design beach slope and construction beach slope. These slopes are rarely the same due to the working limitation of equipment that place and shape the fill material.
  
- \* **Design beach slope:** The design beach slope is for estimating the quantity of fill materials. The foreshore slope of a fill is designed parallel to the local or comparable natural beach slope above low water datum. The offshore slope is derived through synthesis and the averaging of data within and adjacent to the project site. Offshore slope is significantly flatter than the foreshore slope. The initial slope of any beach fill will naturally be steeper than that of the natural profile over which it is placed. The subsequent shape of the slope during and immediately after placement depends on the characteristics of the fill material and the nature of the wave climate.
  
- \* **Construction slope:** During and after the placement of fill material, the selective sorting and winnowing processes by wave and current will eventually shape up the beach profile toward an equilibrium configuration. There are two construction strategies. First, the fill material is placed onshore at an elevation equal to the natural berm elevation. The readjustment of the fill is accomplished entirely by waves and currents that erode and redistribute the artificially piled material and remove the finer sizes through winnowing. The second method is to initially place more of the fill offshore. The redistribution of the material across the profile by waves and currents then takes place offshore rather than onshore.
  
- \* **Beach fill transition:** A nourished beach segment may be compartmented with groins at the two extremes. Alternatively, it may also be a long transition zone

smoothly connecting the nourished beach segment to the natural shoreline at both ends. In general, as the angle that the transition segment makes with the shoreline decreases, so does the rate of erosion per unit length of the segment; however, the volume of fill material will increase since the transition segment is longer. The choice of abrupt transition ends or smooth long transition zones depends on protection desired and economical factors.

- \* **Feeder beach:** All nourished beaches need periodical replenishment. The location where stockpile material can be placed is called a feeder beach. The stockpile material is expected to be transported by littoral processes to the beach area downdrift of the stockpile location. The length of a feeder beach can be a few hundred meters to a kilometer long. The determination of dimensions is primarily governed by economic considerations.

In practice, the quantity of beach fill material can vary from 10 to 20 cubic yards per one foot of beach front. The renourishment period for a nourished beach ranges from 4 to 8 years depending on the storm frequency, previous erosional trend, and acceptable beach conditions in the locale. The extent of fill material in the underwater portion of the foreshore region also affects the renourishment time period. Specific details of a beach renourishment project may be found in district offices of the U.S. Army Corps of Engineers. These details are presented in the form of design memoranda. An analytical approach to assess the beach fill performance is given in reference [12].

With many beach nourishment projects being implemented, the price per cubic yard sand continues to soar. It varies from \$4 to \$8 in the southeastern region, to over \$20 in the northeastern region where sand must be transported from great distances. The initial investment required of beach nourishment and renourishment projects is large. Funds can be raised through the selling of public bonds, subject to legislative vote and public referendum.

2.4.C.2. **Environmental impact:** Beach nourishment projects invariably add huge quantities of materials into the littoral system. These materials are transported alongshore, trapped by inlets and navigation channels, and fill up bays. As a result flushing characteristics, salinity, circulation, and dissolved oxygen content of the nearby bays is affected. When planning a beach nourishment project these affects need to be considered, and better studies need to be undertaken so that adverse reactions will not take place. Insurance that the implementation of a planned renourishment project will not corrupt the sensitive coastal ecosystem is a major step in the approval process.

#### 2.4.D. DETACHED OFFSHORE BREAKWATER

There are two main types of breakwaters, detached offshore and shore connected, which have different functions. The function of a shore connected breakwater is to create calm water for safe and uninterrupted loading and unloading of goods. Harbors throughout the world comprise of these structures. A detached offshore breakwater is designed to protect a shoreline from wave action, serving as a littoral sediment trap. This type of structure is parallel to the shoreline and can be used for two main purposes, formation of tombolo or salient, discussed later.

The detached offshore breakwater attenuates the incident wave energy through a sheltering effect and causes accretion of a beach on the leeward side of the structure. This type of shoreline protection is very popular in Japan, but is not used widely in the United States. The planning and design considerations involve determination of the following [14,15].

- \* Permeability of breakwater: The permeability of the structure is directly linked to the wave energy transmission on the lee of breakwater segments affecting accretion/erosion rates. This transmission is confirmed by field experiments at Holly Beach and Santa Monica Beach in California [5].
- \* Tombolo or salient: When the sediment deposits on the leeward side of a detached offshore breakwater completely fill the space between the structure and shoreline the fillet is defined as a tombolo. A tombolo cuts off the normal littoral transport and temporarily starves the down drift shoreline. It forces the longshore transport to pass seaward of the structure, leading to permanent loss of littoral sediment. A salient forms when the space between structure and shoreline partially fills, establishing an equilibrium of the littoral process. It allows drifting of sediment on the landward side of the structure while protecting the partial fill from erosion. Concluding, a tombolo may be used for widening a severely eroded beach, while a salient is used for stabilization of the shoreline.
- \* Distance from the shoreline: Offshore breakwaters are generally implemented in water depths between 3 and 25 feet. With beach profile known, the distance may be calculated. The distance from the shoreline also has effect on formation of a tombolo or salient.
- \* Length of breakwater segment: Determination of breakwater length comprises of distance offshore and whether tombolo or salient formation is desired. A tombolo would



form when the ratio of shore distance to breakwater length is less than one. A salient forms when the ratio is greater than 1.5. Ineffectiveness of a breakwater to trap sediment on the leeward side occurs when the ratio is greater than two.

- \* **Top elevation of structure:** In determining the top elevation of the structure, formation of a tombolo or salient needs to be known. A higher structure elevation would prevent wave overtopping, encouraging formation of a tombolo. Lower elevation of the structure would allow overtopping and presence of short crested waves would appear in the lee of the breakwater encouraging formation of a salient.
- \* **Spacing between breakwater segments:** A detached offshore breakwater system may consist of a single piece of structure or a series of segments separated by gaps. These gaps control the amount of wave energy reaching the leeward side of the structure. As a rule, gaps should be two wave lengths wide with the length of each segment less than the offshore distance. Fewer gaps of large width or narrow gaps with short segments are examples. Fewer gaps of large width produce large cusped spits (salients), while narrow gaps produce smaller spits, forming a more uniform shoreline. Formation of rip currents at the gaps of the segments during storms cause sand from behind the structure to move offshore, inducing erosion. Properly designing the gap width will minimize this erosional aspect, as shown in the Holly Beach experiments. At Holly Beach a post hurricane survey indicated a 3 to 1 accretion/erosion ratio.
- \* **Structure orientation:** When the breakwater is oriented in the direction parallel to the incident wave crest, the least longshore component of wave energy will be diffracted into the lee of the structure. A low energy environment behind the breakwater would encourage sediment to deposit, therefore the structure should be aligned with predominant incident waves.

Other site considerations should include the local tide range, beach slope, sediment supply and characteristics, and wave climate.

Attempts to stimulate circulation and sand transport behind a detached offshore breakwater using numerical analysis is presented in reference [13]. The effort to understand the physical phenomena and to build a mathematical model is commendable. However, due to imperfection of the sediment transport, the model used in numerical simulation is not valid.

#### 2.4.E. SAND FENCE AND VEGETATION

Dry sand on the beach is transported in three ways, namely, suspension, saltation and surface creep. These natural transportation modes effectively sort the beach material. Smaller particles are removed from the beach and dune area. Medium-sized particles form the foredunes. Larger particles remain on the beach. The function of dunes is to conserve sand in the beach system. Dunes may be destroyed by waves and highwater levels associated with severe storms. Sand fencing and planting of vegetation may be employed to restore dunes. Guide lines for establishing sand fences and planting vegetation are given below [1, 10, 11].

The use of sand fences and vegetation as shoreline protection stems from the naturally occurring dune formations. Sand dunes are valuable, nonrigid structures created by the combined action of sand, wind, and vegetation, often providing a continuous protective system. When severe storms or erosional effects occur and nature fails to rebuild itself, artificial dunes can be constructed through planned sand fencing and vegetation. These methods are briefly described in the following.

2.4.E.1. Sand fencing planning and design considerations: Various mechanical methods, such as fencing made of brush or individual pickets driven into the sand, have been used to construct a foredune. Relatively inexpensive, readily available slat-type fencing (snow fencing) is used almost exclusively in artificial, nonvegetative dune construction. There have been numerous materials, from plastic fabrics to jute mesh, investigated for their uses in dune construction.

Field implementation of dune building with sand fences under a variety of conditions have been conducted at several U.S. sites. The following guidelines are based on these observations.

- \* Porosity: The ratio of area of open space to total projected area of about 50 percent should be used for fencing. Open and closed areas should be smaller than 5 centimeters in width. The standard wooden snow fence appears to be the most practical and cost effective.
- \* Location: Placement of the fence at the proper distance shoreward of the berm crest is critical. The fence must be far enough back out of reach from frequent wave attack. Usually placing the fence line to coincide with the vegetation line or foredune line gives good results.
- \* Fence layout: Only the straight fence alignment is recommended by US Army Corps of Engineers. Fence construction with side spurs or a zigzag alignment does

not increase the trapping effectiveness enough to be economically justified. The fence should be parallel to the shoreline and need not be perpendicular to the prevailing wind direction.

- \* **Trapping capacity:** The trapping capacity is usually described as 2 to 3 cubic yard per linear foot of fence. The foredunes constructed by sand fence and vegetation along Padre Island, Texas contain 275,000 cubic yard of sand per mile of beach over a time period of 5 to 10 years [16]. A recent formulation of sand transport rate is given in reference [10].
- \* **Rows of fencing:** One single row of sand fence is the most cost-effective, however, double-fencing is found in many coastal regions. The spacing for a double-row fence should be 4 times the fence height. The dune height may be elevated by positioning the succeeding fence near the crest of existing dune.
- \* **Height of dune:** Using fencing allows the sand to accumulate to the height of the fence. Studies have shown that fencing with 50 percent porosity have filled to capacity within 1 year. Higher and steeper dunes are produced when lines of fencing are used at differing elevations and spacing.
- \* **Stabilization:** Fence-built dunes can be stabilized with vegetation. Fencing is the first step of a two step process. The implementation of vegetation will strengthen the dunes and keep the trapped sand in place.

The accumulation of sand by fences, however, is not constant and varies widely with the location and time (season, year). Fences may remain empty for months following installation, only to fill within a few days by a single period of high winds.

2.4.E.2. **Vegetation planning and design considerations:** The following are considerations necessary for the implementation of vegetation for shoreline protection.

- \* **Plant selection:** Selection of the vegetation should take into account adaptability to local conditions which include: sun exposure, high temperatures, inundation by saltwater, and drought. The plants that survive this environment are long-lived, rhizomatous or stoloniferous perennials with extensive root systems, stems capable of rapid upward growth, and tolerance of salt spray. The naturally occurring varieties of beachgrasses are the best choices.

- \* **Plant processing:** Plants should be dug so that most roots remain attached to the plant. Clumps should be separated so that transplanting can be done. Storing plants for long periods of time reduce the survival rate. Transplanting is recommended for problem areas, especially to combat erosion. Seeding is only used when erosional and/or wind effects aren't present. Close attention must be paid to disease control and compatibility.
- \* **Planting width:** Plant spacing and sand movement must be considered in determining planting width. When little sand is moved for trapping, and plant spacing is dense, nearly all sand is caught along the seaward side of the planting and a narrow base dune is formed. If the plant spacing is less dense a wider dune is formed but its height is lower. Spacing and pattern should be determined by the characteristics of the site and the objective of the planting.

The mechanism of retaining sand in the littoral regime for planting vegetation is the same as erecting sand fences. However, vegetation planting is season dependent. Species suitable for the coastal environment are limited. Plants are subjected to weather, disease and stress and need fertilization during planting time period. Plants beautify the coastal environment and provide a trapping capacity equal to that of sand fences. A recent study on Padre Island suggested that to duplicate the natural process of dune development and allows the dune field to migrate away from the foredune ridge, the planting should be spaced and be in irregular blocks [11].

## SECTION 2.5. EMERGING SHORELINE PROTECTION TECHNOLOGIES

The following eight shoreline protection methods are either tested out in field demonstration projects or in the process of being tested in the field along the coastline in the United States and abroad.

### 2.5.A. NATURE ASSISTED DUNE RESTORATION - NADR

The dune line along a coast has two distinctive functions. First, it prevents water from overtopping causing flooding of uplands during storms. Second, it serves as a reservoir for storing beach sand.

During a storm, the sea level rises to a dangerously high level. This high storm water level floods the upland and allows waves to attack properties, private and public. Both offshore breakwater and nourished beach will be submerged by the storm tide.

Most properties and coastal land losses are attributed to storm conditions. Remedial methods in past decades have been the employment of seawalls, bulkheads, and revetments. Throughout the years these protective structures served their purpose well, e.g. the Galveston Seawall, but have shown their effects on beaches and shoreline. This has drawn the attention of scientists and engineers alike, causing them to consider alternatives to building hard structures. Since the offshore breakwater and the higher berm elevation of a nourished beach will be submerged by the storm high water level and cannot effectively protect the upland and properties, the method of establishing and/or restoring a dune line for the prevention of coastal flooding and land losses has become the center of attention in recent years.

In reference to the storing capacity of a dune line, the volume equivalent to sand eroded during storms has been trapped and stored in foredunes adjacent to the beach. The foredunes constructed along the Oregon coast contain 900,000 cu.yd. per mile of beach over a time period of 30 years at Clatsop Beach [17]. This accumulation and trapping was primarily achieved by vegetation and sand fences. To speed up this natural process and reduce the time duration for the formation of a healthy dune line, Wang has suggested a method and procedure called NADR (Nature-Assisted Dune Restoration) [18,19]. An outline of Wang's method is described briefly in the following paragraph.

The fundamental basis of finding and placing compatible sand along the coastal shoreline for dune restoration involves the concept of an equilibrium beach profile. Energy input (wind, wave current and tide) to the coastal zone is expended to shape the near shore boundary configuration. For a given energy level, the bottom material acts and reacts with various governing forces in the coastal zone to reach an equilibrium bottom profile corresponding to the energy level. There are two major mechanisms through which the equilibrium bottom profile is reached, namely, accretion and erosion. When the beach accretion phase is identified, a thin layer of sand on the beach is scraped away by a road grader. The natural forces will act to restore the beach profile, moving sand ashore. By repeating this process, large volumes of sand can be obtained for dune restoration. These sands are then placed along the dune line and held there by sand fences and vegetation to form a continuous dune line with dimensions compatible with local environment. During a storm, the sea level rises and waves reach to the dune line and the wave energy is expended to return the dune sand to the beach and offshore bars. After the storm, the "Nature-Assisted Dune Restoration" procedures start and a continuous dune line is restored to be ready for the next storm, thus the operation is cyclic. It is emphasized that this procedure is a closed operational system and no sand will be moved out of the littoral system. Sand is placed where it is needed and when it is needed. This operational process utilizes wave energy to send sand ashore replacing offshore dredging. This method simulates the natural

dune formation process by adding sand to the dune a little at a time, however, it contracts the time from years to months.

Building a continuous dune line along the coastal land has not been easily accepted without concern for long-term effects. Geologists and geomorphologists believe that oceanic overwash is an important process in the landward migration of barrier islands. Since a foredune system blocks overtopping and prevents oceanic overwash, a continuous foredune is viewed as a threat to barrier island stability. This theory was overturned by a recent study conducted by Leatherman [20]. Leatherman pointed out that oceanic overwash is not the dominant process for barrier island migration since the amount of sediment transported by overwash is too small. A far greater quantity of sediment is moved into bays and lagoons through old and new tidal inlets. Since the restored dune line is meant to be destroyed by storm tide and returning sand to the beach and offshore bar, the establishment of a continuous dune line can contribute to the stability of beaches as well as saving coastal land and properties.

#### 2.5.B. SUBMERGED GROIN SYSTEM

2.5.B.1. Holmberg Technologies: Holmberg Technology's Undercurrent Stabilization Anchor Systems (USAS) appears to be groin-like structures [8]. Like a groin field, the USAS has slender structure segments perpendicular to the shoreline. Unlike a groin field, the USAS is submerged in water, not necessarily connected to shoreline, and the distance between single segment is very short. According to Mr. Dick Holmberg, the USAS works like "speed-bumps", or "artificial delta regions" which act "as storage/feeder areas that load with transported sand during storms and then release sand again after the storm."

The USAS may be an interesting concept. However, it lacks scientific and engineering details for implementation in the field. Mr. Holmberg must release the dimensions of the USAS structure, the depth of submergence, the location relative to the shoreline, construction material and methods. He must also explain in scientific and engineering terms how and why the USAS would work.

Mr. Holmberg has submitted a proposal to Galveston County Beach Park Board of Trustees for "Restabilization of the Galveston County Coastline" which recommends installing two permanent USAS units for \$2,490,000. This proposal along with comments on the proposal by Wang may be found in Appendix A of this report.

2.5.B.2. Artificial Headland for Beach Improvement: Similar concept and technique is being tested on the coastline of South Africa. Assessment will be made when the information and data are made public by the investigating company.

### 2.5.C. BEACH DRAIN SYSTEM

There are several beach drain systems, namely, the StaBeach System, the Beach-Advancer System, and the Horizontal Dewatering System, etc.. These systems utilize beach face dewatering method to encourage sand deposit on the beach face. However, they differ in installation methods. During the wave uprush cycle, sand is brought onto the beach and the returning backwash cycle takes sand off the beach. The dewatering technique works on the backwash cycle. When the ground water table is lowered by pumping water out of the subsurface of the beach, sand movements are retarded by the effect of percolation during the backwash cycle, thus leaving additional sand on the beach. Figure 1 explains the concept more clearly.

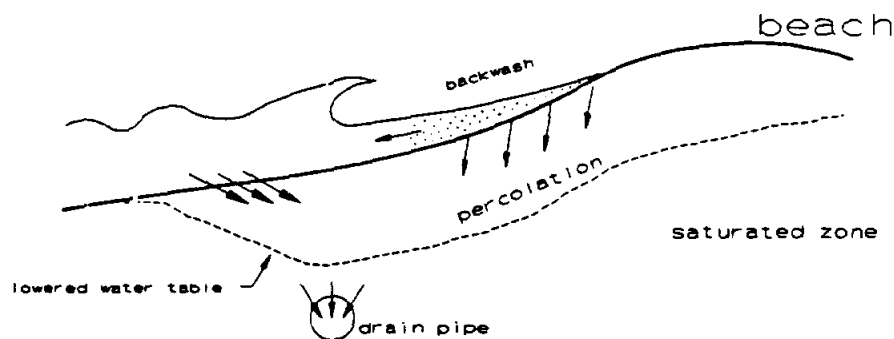

Figure 1.

The engineering design details should include the following:

- Buried piping system
- Pumping rate and capacity
- Ground water table line before installation
- Ground water table line during operations
- Location and spacing of the pumping stations

A general description of the Stabeach [21] and comments on the Stabeach concept by Wang is appended in Appendix B.

Since last reported in the progress report #2, the StaBeach System has improved its installation procedures. The so called "self-burial" technique that reduces costs for emplacing pipe has been developed [27]. The location of burying the drain pipe is also moved to the seaward of mean-low-water (MLW) in an attempt to widen the beach face. Testing projects are in progress at Long Beach, Maryland, St. Petersburg Beach and Vero Beach in Florida [28].

The Horizontal Dewatering System [29] on the other hand has streamlined its operation by using specialized patented equipment to shorten the installation time and to reduce the excavation area for pipe burial. A general description of the Horizontal Dewatering System may be found in Appendix D.

More beachface dewatering studies have been performed under the controlled laboratory conditions at Lehigh University. The study results are given below [30].

"There is no significant effect on the rate of erosion or accretion as measured at the stillwater line when the beach drain is used for the condition of no tide. There was however a buildup of sediment near the upward extent of the swash. In addition, the beach drain caused the resulting equilibrium profiles to be somewhat steeper in the region of the beach face when compared to the corresponding profile without the drain operating. These results indicate that the beach drain would not be effective in prototype installations where there is a negligible tide".

#### 2.5.D. MAC-BLOX, AN ENERGY ABSORBING REVETMENT

In recent years, there have been developments of energy absorbing structure elements for shoreline erosion control. The Mac-Blox is only one example in the market place. The basic principles of shoreline structure for absorbing wave energy that Mac-Blox has incorporated in its design are

- \* Sloping surface: To reduce wave slamming and rebounding
- \* Rough surface: To impede and diffuse wave runup/rundown
- \* Internal void spaces: To absorb and dissipate wave energy



Mac-Blox is made of concrete and weighs 300 pounds a piece. These blocks are placed to form a step-like sloping revetment and then locked together with concrete piling in groups of ten or more. The shape, dimension and various arrangement of Mac-Blox for shoreline stabilization may be found in Appendix C.

#### 2.5.E. A VISCOUS DRAG SYSTEM

The Viscous Drag System is an "erosion control mat" which provides high resistance to water movement with 3.8 million square inches of wetted area (or drag surface) per mat. This large area of drag surface retards the current velocity and causes sediment to deposit in the "mat", thus, builds up a fiber reinforced soil bank. When this "soil bank" is placed along the shoreline in shallow coastal waters, it serves as an offshore breakwater to cause the formation of a tombolo on the shoreline. As a result, the beach is widened and the shoreline may thus be stabilized.

The Viscous Drag System has been used as the underwater foundation soil to support the footings of a substructure, such as underwater pilings and pipe lines. However, it has not been so far utilized for shoreline erosion control. The principles and field layouts of the "erosion control mat" may be found in Appendix E.

#### 2.5.F. LITTORAL DRIFT MANIPULATION: T-GROIN AND HEAVY SAND

This is an innovative and unique approach to shoreline protection [22]. This method combines beach nourishment and T-groin into one unit. The fill material for beach nourishment is shipped-in foreign sand and is heavier than local sand. This imported sand is not allowed to drift outside the project area; therefore, T-groin is employed to keep the foreign sand in place. The T-groin compartments are also used for altering the normal littoral drift direction. This is done by properly aligning the T-head of a groin in relation to dominant incident waves. This experimental project is heading toward completion and will have a 5-year follow-up monitoring program of the testing project. Valuable technical information will be collected by the monitoring program.

A T-groin installation at Hilton Head Island, South Carolina is working well to protect the receding shoreline. The engineering design and arrangement for the Hilton Head Island project is given in Figure 2.

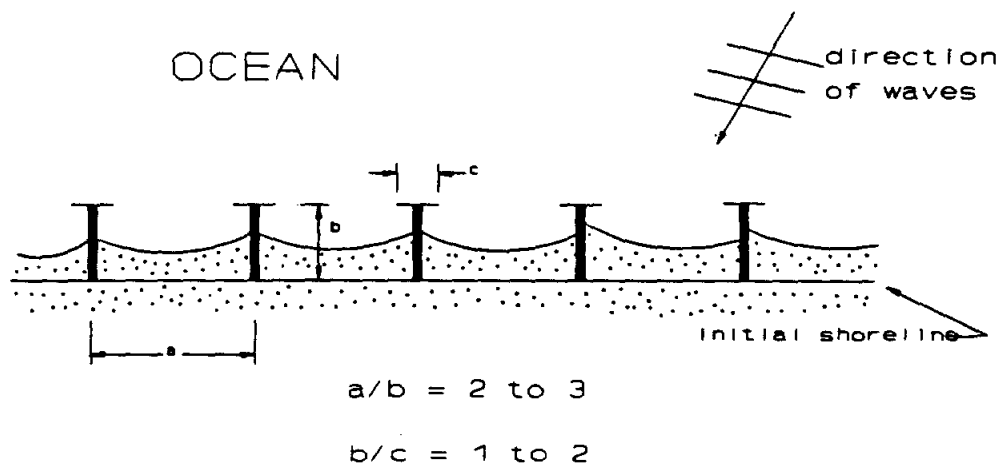

Figure 2.

The mechanism at work for the T-groin is similar to that of detached offshore breakwater segments. However, there are significant differences. T-groins block the littoral drift completely. The offshore breakwater may be designed with appropriate distance from shoreline, structure permeability, and top elevation of the breakwater segments allowing the formation of a partial tombolo (or salient) so that normal littoral drift is not completely cut off.

Since last reported in the progress report #2, the field experiment of the T-groin with heavy sand at Fisher Island, Miami is scheduled for completion. Aerial photographs indicated that the shoreline configurations match the engineering design well at the time of Coastal Sediment '91 Conference in Seattle, Washington.

#### 2.5.G. DREDGED MATERIAL PLACEMENT

The environmental effects of dredging practice and the desire to conserve sand resources in the coastal zone have led the US Army Corps of Engineers to consider alternatives to the disposal methods of dredged material. Toward this end, the US Army Corps of Engineers has been constructing the so-called experimental submerged berm on open seafloor offshore regions in Alabama, California, North Carolina, New York and Texas. These experiments were carried out in a variety of physical conditions in an attempt to provide answers to the following questions:

Whether sand in the submerged berm will be retained in the nearshore zone or lost seaward.

What are the forces necessary for dispersion of the material shoreward.

What should be the design criteria for establishing a submerged berm, such as berm dimensions and depth of submergence, etc.

The degree of effectiveness of the submerged berm for reducing (i) wave damage to the shoreline, and (ii) the rate of coastal sand losses to deep offshore waters.

What are the requirements for the design of new equipment to economically and effectively place the sand in shallow water, such as the draft requirements and the releasing mechanism for control of sand placements.

In December 1990, the Dredging Research Program, US Army Corps of Engineers formally released its first report on the performance of an experimental submerged berm [23]. An inconclusive result is reported in this experimental study. However, some engineering details are worthwhile to briefly mention in the following:

The experimental submerged berm study is located at Sand Island, Alabama.

The dimensions of the submerged berm are 6000 ft. long, 500 to 700 ft. wide across the base, and 6 to 7 ft. in height.

The sand diameter is 0.2 mm, the depth of sand placement is below 14 ft. and above 20 ft. MLLW depth contour gives a submergence depth of 12 to 13 ft. from the crest of the submerged berm.

Monitoring techniques include bathymetric surveys, sediment samples, side-scan sonar documentation, aerial photography, seabed drifters, and meteorological wave and current meters.

The size and shape of the submerged berm remained unchanged throughout the 12-month monitoring time period. No evidence suggested offshore loss of sand.

Therefore, the experiment is considered inconclusive.

Judging from this most recent report put forth by US Army Corps of Engineers, it is perhaps still a few years away before the submerged berm concept can be implemented and adopted for general practice.

#### 2.5.H. BEACH PROFILE MANIPULATION

The idea of beach scraping was formulated in the 1970's by Davenport, Smutz and Wang [24]. Later, Kana and Svetlichny had conducted an independent field experiment at Myrtle Beach, South Carolina and their findings were reported in 1982 [25]. This experiment involved moving 100,000 cubic meters sand from the lower beach to the backbeach over a 14 kilometer length of shoreline. Beach profiles were measured repeatedly to determine the effect of scraping and fill along a stable-to-slightly erosional beach. Kana and Svetlichny stated that "the purpose of the scraping and fill was to provide temporary erosion relief, protect existing dunes and structures, and provide a wider recreational beach at high tide." The experiment indicated that results were mixed and were dependent on the pre-existing shoreline conditions, such as armored and unarmored dune lines, stable and erosional beaches. Kana and Svetlichny drew the following conclusions:

Stable shoreline: Beach scraping should be highly preferred over armoring.

Slightly erosional shoreline: Beach scraping is at best temporary, but may be a suitable interim measure until long-term solutions can be implemented.

Highly erosional shoreline: Beach scraping will produce little benefit and may accelerate erosion of the backbeach.

Per Bruun also conducted a field experiment at Hilton Head Island, South Carolina and published his results in 1983 [26]. Bruun reported that "beach scraping by skimming of thin surface layers where surplus material is available in the profile is not harmful, but rather beneficial as coastal protection of eroding dunes and dikes. Undertaken in a technically responsible way it also has beneficial rather than adverse effects on adjacent beaches." He also concluded that "Beach scraping is a way of organizing available beach material in a more sensible way on short term basis. But it is a temporary measure only."

Based on the concept of equilibrium beach profile elucidated in the section 2.5.A. the results of Kana and Svetlichny and Bruun are logical indeed. The energy input to the coastal zone is in equilibrium with the bottom configuration. When material is moved from lower beach to backbeach by scraping, this tips the equilibrium profile and natural forces will restore it by moving

away the excess material placed on the backbeach. An important point to be made here is that even though the beach scraping cannot widen the eroding beach and is a temporary measure, it can be utilized very effectively and economically for building the dune line for prevention of flooding and coastal land losses [19].

## SECTION 6. FUTURE TRENDS

New methods and ideas of shoreline protection will be funded and tested in laboratories and the field. A large share of these studies will be done by academia and industry, where previously they were predominately done by US Army Corps of Engineers.

The "soft approach" to shoreline protection will continue, although hard structure cannot be completely avoided particularly for high energy coast. There will be a combination of "soft and hard" structures with soft structure dominating.

There will be more efforts to deal with submerged bottom profiles. A comprehensive look and treatment of the entire littoral bottom configuration will replace the piecemeal approach of treating the dune, the beach face, and offshore bars separately.

More collaborating works between scientists, engineers and economists in coastal zone management will be seen. Industry, government and academia working together will be the future trend.

## SECTION 7. CONCLUSIONS

The discussed methods of protecting the shoreline all have their merits and limitations. The engineer-planner can choose one single method or a combination of several methods for an intended project, depending on the primary purpose of the project, the degree of protection required, the acceptable "side effects" or environmental impact, and the preference of the individual. In the final analysis, economic justification will play an important role in the decision making process of the method to be chosen.

There are two important conferences on shoreline protection and coastal zone management which has been convened this year. The conference on Coastal Sediments '91 is scheduled in June at Seattle, Washington and the conference of Coastal Zone '91 is in July at Long Beach, California. More than 800 technical papers, including one from the author, will be presented at these two conferences. After a review of these conference proceedings, this report has been updated to include the newest methods in shoreline protection.

## REFERENCES

1. US Army Corps of Engineers, 1984, "Shore Protection Manual" second printing, two volumes.
2. Kraus, N.C., 1987, "The Effects of Seawalls on the Beach: A Literature Review," Coastal Sediments '87, Vol. 1, pp. 945-960
3. McDougal, W.G. et al, 1987, "Structure on Adjacent Properties," Coastal Sediments '87, Vol. 1, pp. 961-973
4. Baba, M. and Thomas, K.V., 1987, "Performance of a Seawall With A Frontal Beach," Coastal Sediments '87, Vol. 1, pp. 1051-1061
5. Sonu, C.J. and Warwar, J.F., 1987, "Evolution of Sediment Budgets in the Lee of a Detached Breakwater," Coastal Sediments '87, Vol. 2, pp. 1361-1368
6. Douglass, S.L. and Weggel, J.R., 1987, "Performance of a Perched Beach-Slaughter Beach, Delaware," Coastal Sediments '87, Vol. 2, pp. 1385-1398
7. Krafft, K. and Herbich, J. B., 1989, "Literature Review and Evaluation of Offshore Detached Breakwaters," Technical Report No. COE-297, Ocean Engineering Program, Texas A&M University, 98 pages
8. Holmberg, D., 1990, "Holmberg Technologies: Undercurrent Stabilization Anchor System," 23 pages, see Appendix A of this report
9. Erchinger, H.F., 1991, "Design of Beach Fill Profile After the Equilibrium Profile - Even on the Forebeach," National Conference on Beach Preservation Technologies, Charleston, South Carolina
10. Tsuchiya, Y., 1987, "Sand Transport by Wind: Transport Rates of Uniform and Graded Sand," Coastal Sediment '87, Vol. 1., pp. 175-187
11. Mathewson, C.C., 1987, "Aeolian Processes - A long Term coastal Sediment Transport Mechanism," Coastal Sediments '87, Vol. 1., pp. 222-235
12. Chou, I.B. et al, 1983, "Assessment of Beach Fill Performance by Excursion Analysis," Coastal Zone '83, San Diego, California, pp. 2361-2377

13. Zarillo, G. and Liu, J.T., 1991, "Testing the Feasibility of Offshore Breakwaters Using Numerical Models of Nearshore Circulation and Sand Transport," National Conference on Beach Preservation Technologies, Charleston, South Carolina
14. Dally, W.R. and Pope, J. 1986 "Detached Breakwaters for Shore Protection," US Army corps of Engineers, Waterways Experiment Station, Coastal Engineering Research Center, Technical Report 86-1, 62 pages
15. Pope, J. and Dean, J.L., 1988, "Development of Design Criteria for Segmented Breakwaters," XXI Conference on Coastal Engineering, American Society of Civil Engineers.
16. Dahl, B.E. et al, 1975, "Construction and Stabilization of Coastal Foredunes with Vegetation: Padre Island, Texas," MP 9-75, US Army Corps of Engineers, Waterway Experiment Station, Coastal Engineering Research Center, Vicksburg, Mississippi
17. Meyer, A.L. and Chester, A.L., 1977, "The Stabilization of Clatsop Plains, Oregon," Shore and Beach, pp.34-41
18. Wang, Y.H. , 1982, "A Cost-Effective Beach Building and Maintenance," Proceedings, Ocean '82, Washington D.C., pp. 980-983
19. Wang, Y.H., 1991, "Nature-Assisted Dune Restoration," Proceedings, Coastal Zone '91, Long Beach, California. pp. 2816-2822
20. Leatherman, S.P., 1988, "Barrier Island Handbook," Laboratory for Coastal Research, University of Maryland, College Park, Maryland, 4th Ed., 92 pages
21. Coastal Stabilization, Inc., 1989, "Stabeach System," 4 pages, see Appendix B of this report
22. Olsen, E. and Bodge, K., 1991, "Caribbean Beach Fill and Mediterranean Structures at Southeast Florida," National Conference on Beach Preservation Technologies, Charleston, S.C.
23. US Army Corps of Engineers, 1990, "Results of Monitoring the Disposal Berm at Sand Island, Alabama, Report 1, Construction and First Year's Response," Technical Report DRP-90-2, 59 pages
24. Smutz, M., Leadon, M.E. and Wang, Y.H., 1978, "Summary Report for the Dredging Seminar", Dredging Seminar, Miami Beach, Florida, pp. 170-175
25. Kana T.W. and Svetlichny, M., 1982, "Artificial Manipulation of Beach Profiles," Coastal Engineering, pp. 905-922

26. Bruun, Per, 1983, "Beach Scraping - Is It Damaging to Beach Stability?" Coastal Engineering, pp. 167-173
27. Parks, J.M., 1991, "New Dredging Technology for Inlets and Beaches: Move Sand to the Pump", Proceedings, Coastal Sediments '91, Seattle, Washington. pp. 1943-1954
28. Parks, J.M., 1991, "Pumping In and Pumping Out - Case Histories of Fluidized Sand Bypassing for Channels and Beach Face Dewatering for Beaches", Proceedings, Coastal Zone '91, Long Beach, California. pp. 193-203
29. Justice, D.R., 1991, "Horizontal Dewatering System for Shoreline Stabilization", Proceedings, Shoreline Erosion Seminar, Galveston County, Texas, Texas A&M University Sea Campus, Galveston, Texas. pp. 120-127
30. Ogden, M.R. and Weisman, R.N., 1991, "Beach Stabilization Using Drains - An Experimental Model Study", Proceedings, Coastal Sediments '91, Seattle, Washington. pp. 1955-1969
31. Olsen, E.J. and Bodge K.R., 1991, "The Use of Aragonite As An Alternative Source of Beach Fill in South Florida", Proceedings, Coastal Sediments '91, Seattle, Washington. pp. 2130-2144



**CHAPTER 3**

**IDENTIFICATION AND ANALYSIS OF SHORELINE PROBLEMS  
AND  
RECOMMENDATION OF SHORELINE PROTECTION OPTIONS  
IN  
GALVESTON COUNTY, TEXAS**

## TABLE OF CONTENTS FOR CHAPTER 3

SECTION 3.1.	Introduction.....	37
	A. Physical Environment	
	B. General Characterization of Galveston Shoreline	
SECTION 3.2.	Shoreline Erosion Along Bolivar Peninsula.....	41
SECTION 3.3.	Rollover Pass.....	43
SECTION 3.4.	Galveston Seawall and Groin Field.....	44
SECTION 3.5.	West End of Galveston Seawall.....	51
SECTION 3.6.	Galveston West Beach.....	55
SECTION 3.7.	San Luis Pass.....	57
SECTION 3.8.	Texas City Dike.....	59
SECTION 3.9.	Shoreline Erosion in Galveston Bay.....	59
SECTION 3.10.	Data Requirement and Acquisition.....	60
SECTION 3.11.	Conclusions.....	60
REFERENCES.....		61

## SECTION 3.1. INTRODUCTION

The Galveston region has several coastal problem areas that need shoreline protection implementation. There are two functional entities that are common to all the project sites; the forcing function such as natural forces in the coastal zone and the response function such as location parameters. Understanding these two functions and their interactions at different project sites will provide valuable information for better project decisions and/or implementation.

### 3.1.A. PHYSICAL ENVIRONMENT

When physical environment is mentioned in the coastal region thoughts on natural processes comes to mind.

Location parameters such as the orientation of shoreline, sheltered or exposed, open to long or short fetch, bottom topography, and sediment materials, etc. Natural forces, such as waves, tides, winds, and currents, etc. that shape up the bottom configuration of the coast zone. The interaction of these two, or the natural processes, determine the shoreline change in that region. Shoreline changes are also possible through man's interference of the natural processes. Both natural and man made shoreline changes can be good or bad depending on whether or not the change induced effects are in the viewers' favor.

The boundary of the Galveston shoreline facing the Gulf of Mexico starts from the intersection of State Highway 124 with Highway 87 at High Island, and ends at San Luis Pass. This shoreline has a general northeast-southwest orientation approximately 60 miles long. Within this stretch of shoreline, there are two natural tidal inlets, Galveston Bay entrance and San Luis Pass, and one man made inlet, Rollover Pass. These inlets are separated approximately equidistant from each other, and all are connected to Galveston Bay. Rollover Pass and Galveston Bay inlets are regulated by structures, San Luis Pass has no regulating structure.

Weather plays an important role in the physical makeup of the shoreline. The history of a location, especially data on shoreline parameters, provides guidelines to the understanding of the site's adjustments to natural forces. Understanding how a shoreline responds to these forces and taking into account all planning and design considerations will lead to an overall view of the location's attributes, therefore opening the door to solving the area's problems.

The prevailing winds are mostly from the south and southeast directions with a speed of up to 15 knots. There are about 15 to

20 northeasters with speeds up to 50 mi/hr passing through this region during winter [1]. In the past century, there have been numerous hurricanes within a 200 mile radius of Galveston. Hurricane Carla in 1961 produced the greatest storm surge on record in the region [2]. High water levels greater than 5 feet can occur once every two to three years [2].

The astronomical tides vary between diurnal and semi-diurnal and are less than 2 feet. The wave climate in this area is generally mild, heights less than 2 feet half of the time. The average magnitude of longshore current is 0.8 ft/sec southwest 56% of the time and 0.67 ft/sec northeast [1].

### 3.1.B. GENERAL CHARACTERIZATION OF GALVESTON SHORELINE

The general characterization of the Galveston shoreline takes into account the effects of location and natural forces on each of the individual areas, while trying to present an overall view of the region. Since the Galveston region is broken into eight (8) different problem locations, there would be eight different problems to be solved. The key for stabilizing, thereby solving, the shoreline problems is to investigate each individual location and the effects that it has on the other locations.

The Galveston shoreline comprises of two main problems; erosional tendencies and unwanted accretion. Erosion problems occur near the High Island, Rollover Pass, and Galveston west beach, while unwanted accretion may be found in Rollover Bay, Big Reef, and Galveston West Bay. Structures are present and occupy the middle section of County's shoreline. The relationship of all these problem areas need to be investigated, and an overall regional understanding will provide answers to the coastal shoreline problems. The Galveston shoreline can be broken into four major areas for general characterization, as shown in the following figure.

# Galveston Shoreline Characteristics

39

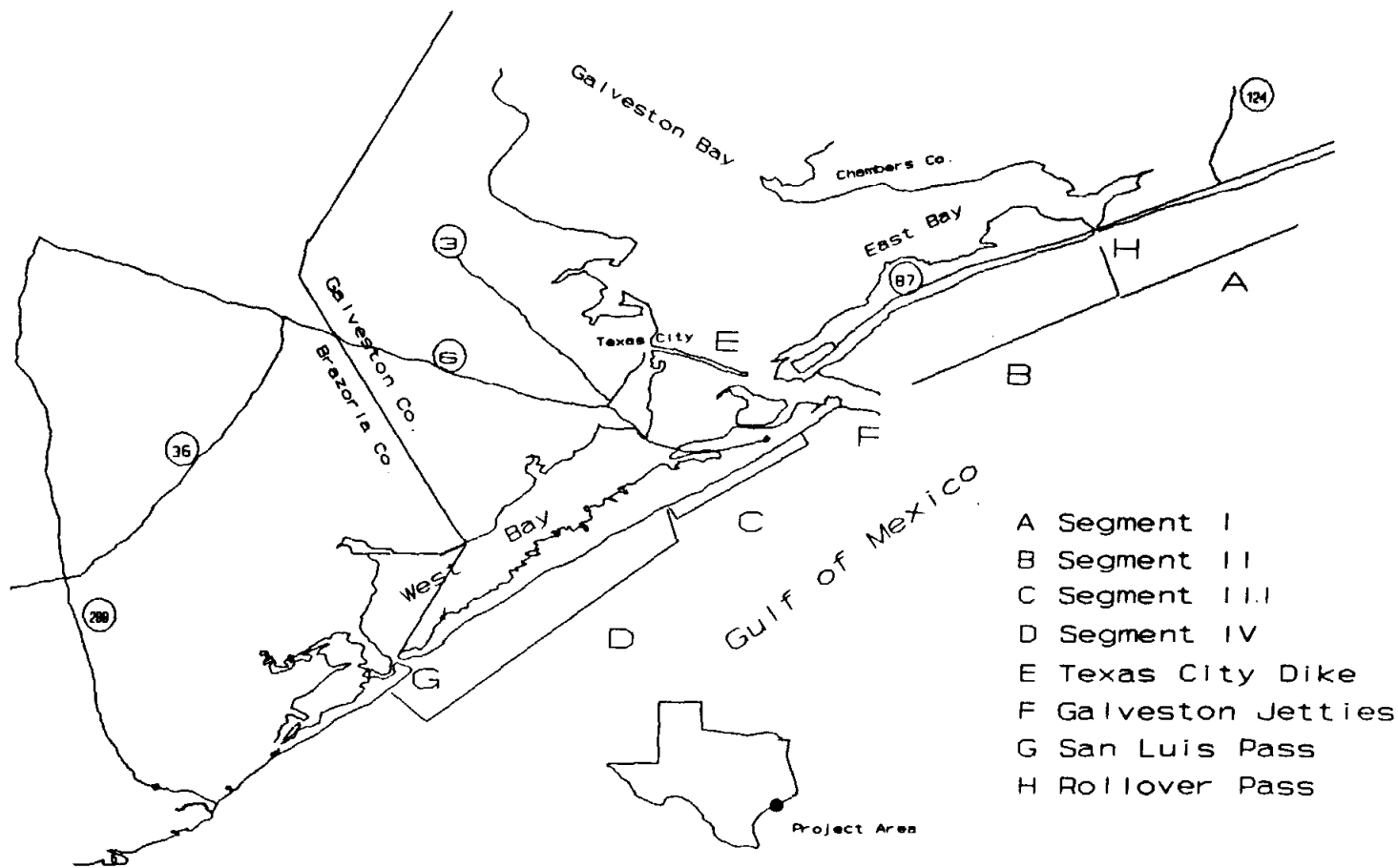

Project Area

Segment I: Location of this portion is the extreme northeast boundary, High Island to Rollover Pass. East of this segment is Sabine Pass and adjacent coastline that serves as a sediment supply source. Rollover Pass, southwest part of segment, serves as a sediment sink. This segment's shoreline is relatively straight with a northeast orientation.

Segment II: This portion is from Rollover Pass to the Galveston Bay entrance. The north jetty serves as the boundary, forming a discontinuity of longshore transport. The shoreline orientation is slightly concave towards the south due to the accumulation of sediment on the north side of the jetty.

Segment III: This area takes into account the Galveston Bay entrance to the west end of Seawall Boulevard. This segment has its littoral processes modified by man made structures. Sediment discontinuity occurs at the south jetty, then is influenced by the groinfield and seawall. Shoreline orientation follows the structures, with little beachfront being present.

Segment IV: This portion contains shoreline from the end of the Galveston Seawall to San Luis Pass. This segment encompasses 18 miles of natural sandy beaches with residential communities intermittently developed along the shoreline. The southwestern end, San Luis Pass, marks the boundary of the Galveston coastline, and serves as a sediment sink.

The following are the individual projects within the Galveston region. Each has its own problems which, by the will of the public, need to be solved. These problems will be investigated and a solution will be given, along with options, in order to stabilize the shoreline.

# Bolivar Peninsula Ferry Landing

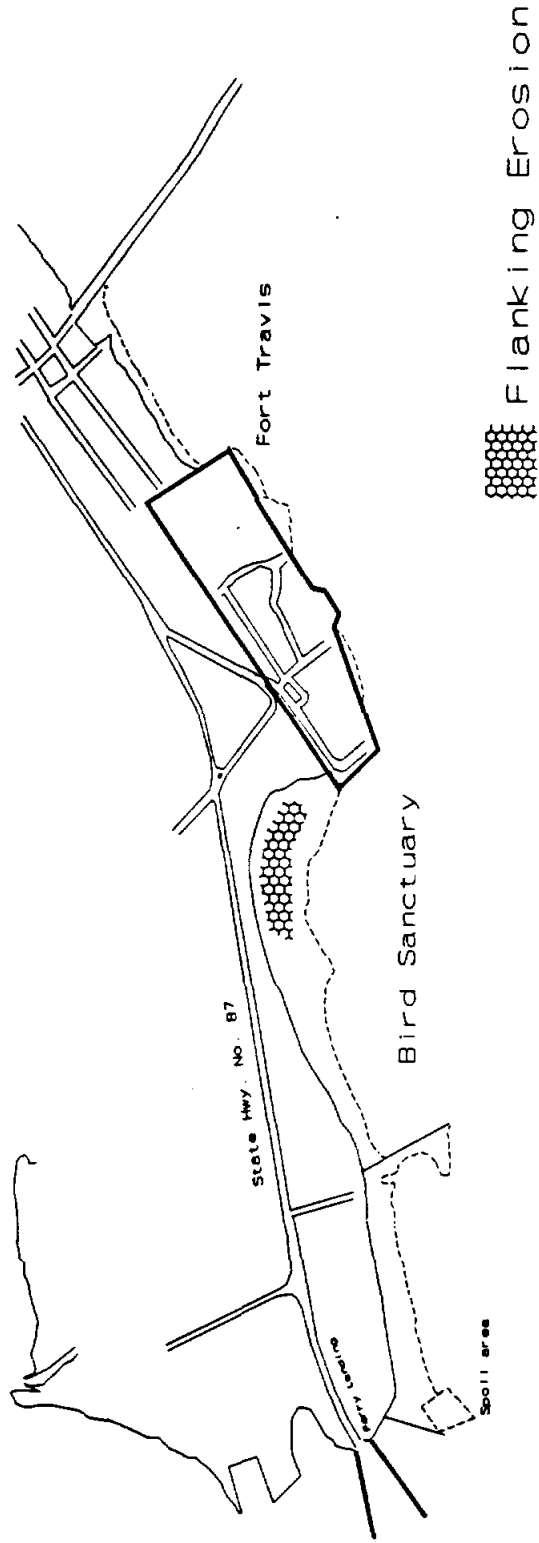

## SECTION 3.2. SHORELINE EROSION ALONG BOLIVAR PENINSULA

There are three problem areas along Bolivar Peninsula, the shoreline between High Island and Gilchrist, Rollover Pass, and the road at the ferry landing. Problems at Rollover Pass and vicinity are complex and will be treated separately in the next section.

### 3.2.A. SHORELINE BETWEEN HIGH ISLAND AND GILCHRIST

3.2.A.1. The problem and analysis: The beach between High Island and Gilchrist is narrow. The waterline is close and parallel to State Highway 87. During severe storms this stretch of highway becomes inundated becoming vulnerable to washing out. The narrow beachfront and closing-in waterline is not an isolated phenomenon, a typical erosional scene is found along the shoreline between Sabine Pass and High Island. Some stretches of Highway 87 is closed to traffic along this section.

3.2.A.2. The objective and solution: The single objective is to stop shoreline erosion. Since the problem is not isolated, it must be solved as a part of the bigger problem area from High Island to Sabine Pass.

### 3.2.B. ROAD AT FERRY LANDING

3.2.B.1. The problem and analysis: The shoreline erosion immediately after the ferry landing piers on Bolivar Peninsula threatens the integrity of the ferry landing road. The possible cause of the problem may be due to tidal currents interacting with the seawall, in place at Fort Travis, causing flanking erosion. Naturalists have suggested making the shallow water regions between the ferry landing and north jetty a bird sanctuary.

3.2.B.2. Objectives: Stop the advancement of flanking at the ferry road location without interfering with the shallow water bird sanctuary.

3.2.B.3. Options for attaining objectives: There are two ways to protect the ferry landing road; use of soft approach and hard structure. In this case the hard structures are preferred over the popular trend of soft approaches for the following reasons.

The softer approach is to fill in the eroded area (approximately 25 acres in size) periodically in cooperation with the annual dredging schedules of the ferry landing piers which amounts to 200,000 cubic yard per year. The major drawback to this option is the reduction of shallow bay area by filling-in with materials. State and federal agencies and environmental groups have all expressed their concerns.



Armoring is another option. The placement of a seawall or rubble mound revetment can be implemented. There are new designs of armoring units for absorbing and dissipating wave energy. These designs are aimed to replacing the vertical bulkhead/seawall in sheltered areas, which may be worth looking into. This type of armoring will be compatible with the Fort Travis shoreline and does not interfere with the natural bird sanctuary.

A groin system with proper design of length and spacing can also serve the function of stabilizing the shoreline without reducing the shallow water bay bottom area.

A detached small breakwater segment parallel to the waterline to encourage accretion in the eroding area through natural processes is another option can be worked out.

Finally, the use of the concept of a "feeder beach" could solve both the eroding shoreline problem at the ferry landing road and the silting problem at the ferry landing piers. This may be done by locating a feeder beach site on which the dredging material from the ferry landing piers may be placed and these materials are then distributed by waves and tidal current to the eroding area along the ferry landing road.

### SECTION 3.3. ROLLOVER PASS

Rollover Pass was originally constructed by the U.S. Army Corps of Engineers in an effort to create a marine nursery ground in unproductive waters of Galveston East Bay. Ever since the man made cut was open, middle 1950's, excessive erosion has occurred on the downdrift and updrift sides of the cut. Rollover Bay is choked with massive sediment deteriorating the water quality. A comprehensive plan using an integrated system approach was proposed by Wang in "Preliminary Designs of Improvements at Rollover Pass and Vicinity, Bolivar Peninsula, Texas" [3]. This document is supplied as Appendix F.

Galveston Seawall Vicinity

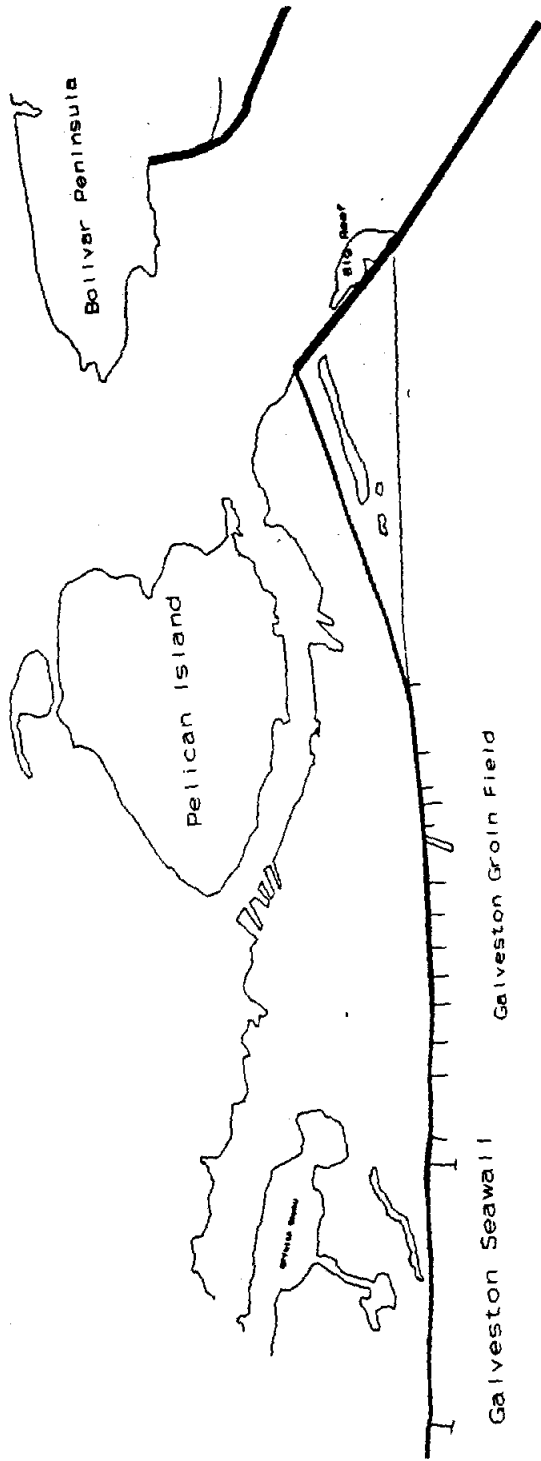

## SECTION 3.4. GALVESTON SEAWALL AND GROIN FIELD

### 3.4.A. STATEMENT OF PROBLEMS

Construction of the Galveston Seawall started in 1902 and now extends 10 miles. The groin field was constructed between 1936 and 1939 with the final configuration completed during 1968-70. The groin field occupies a seawall segment approximately 4.5 miles long. The main purpose of the seawall is for protection of the uplands behind it. The construction of the groin field is for stabilizing the shoreline by impeding littoral sand movement for protection of the seawall foundation. Both structures serve their intended purposes well. In the mean time, however, the degradation of beach in front of the seawall occurs. Today there is no appreciable recreational beach in front of the seawall.

At present, the shoreline along the seawall appears stable, although waves directly pounding at the seawall are observed during rough weather. The integrity and safety of the existing seawall structure must be calculated since the investment of the structure, property, and life behind it is great. This cannot be taken lightly. Suppose a hurricane with the strength of "Hugo" directly hits Galveston Island. This hurricane may produce storm surges in excess of 20 feet with waves of 16 feet in height directly pounding at the seawall, causing scour of the structure toe. The ability and current conditions of the concrete slab and riprap aprons at the structure toe to withstand this scouring power is of interests to coastal engineers.

### 3.4.B. OBJECTIVES

The primary objective is to restore the beach in front of the Galveston Seawall. A secondary objective is to provide an extra measure of safety and integrity for the seawall under extreme conditions.

### 3.4.C. OPTIONS FOR ATTAINING OBJECTIVES

3.4.C.1. Plain beach nourishment: Beach nourishment is the most popular shoreline restoration and protection method in the United States. It has been widely adopted along the Pacific, Atlantic, and Gulf of Mexico shorelines. This method allows the designer to provide desired beach width, berm elevation, and beach slope. The results are immediate and impressive. Since the objective is to restore a beach along the seawall for recreational purposes, beach nourishment is the only method that can deliver prescribed beachfront dimensions quickly.

The general technical information on the planning and design details regarding a beach nourishment project may be found in the previous progress report. The following is site specific information that the engineer should take into account in addition to the design considerations given previously. This information is by no means exhaustive.

- \* Assume the project length will cover the full length of Galveston Seawall. The end conditions (see section 3.1.B.) of the project area will dictate the behavior and movement of new sand used in the beach nourishment project.
- \* The continued growth of Stewart Beach, East Beach, and the Big Reef, along with the siltation of San Luis Pass and Galveston West Bay are observable. These phenomena suggests that there is no strong predominant littoral transport direction along the Galveston shoreline. The magnitude and direction of the longshore currents in Galveston coastal waters (see section 3.1.A.) suggests that the direction of longshore sediment transport is reversible.
- \* After beach restoration is completed, it is expected that Stewart Beach, East Beach, and the Big Reef will continue to grow at a faster rate while the erosion rate along Galveston's west beaches will be slowed.
- \* The Galveston Bay South Jetty and the ship channel at the northeast end of the proposed project area form a discontinuity of littoral transport. While the boundary condition at southwest end of the project area allows the littoral material to move with little obstruction.
- \* Valuable lessons have been learned from the pilot (mini) beach nourishment project that took place in front of the San Luis Hotel during the Spring of 1985. Sand was trucked in from the east end of the island and dumped in front of the seawall between the groins. This pilot project provided clues on design berm elevation, design slope, overfill factor, erosion modes and rates, and the interaction between groins and the new sand. Unfortunately, the project was not well planned nor monitored to yield accurate scientific data for engineering planning and design purposes.
- \* Data from the monitoring of the pilot project follows [4].
  - The monitoring period was 17 months
  - The native beach grain size ranged from 0.10 to 0.42mm
  - The borrowed sediment grain size ranged from 0.08 to 0.15 mm

- The borrowed volume was 11,460 cubic meters
  - The shoreline retreated 52 meters in 17 months
  - 16% of filling material was lost in 17 months
  - Losses of beach material were due to: (i) movement to offshore, (ii) end losses, (iii) profile adjustment, and (iv) eolian transport.
- \* The end losses at groins which confined the dumped nourished sand indicated that the design berm elevation should not be much higher than the storm berm elevation in order to reduce the unwanted losses.
  - \* The eolian transport is significant in the pilot project. If the width of newly nourished beach is to include a parking strip along the seawall base, the eolian transport must be carefully considered.
  - \* The monitoring program indicated a 52 meters of shoreline retreat in 17 months. This high rate of shoreline retreat needs to be reduced. Further study of options for reducing the shoreline retreat rate is highly recommended.

3.4.C.2. Groin field: A groin field alone may not be able to attain the primary objective described in Section 5.B., since a groin field is already in place over the middle 4.5 miles of the Galveston Seawall. The existing groin system has variable lengths and spacing between individual elements. If a new groin field is chosen for trapping longshore drift and building a beach, the groin cross-section, groin length, and spacing must be checked and re-calculated.

On the nontechnical aspect, to many individuals a groin field is not eye pleasing due to the crescent shape and segmentation of the beach.

3.4.C.3. Offshore detached breakwater: Among the established methods of shore protection, the offshore breakwater is the one that could be used to protect as well as widen a beach. Projects that employ an offshore breakwater can be found on both the Pacific and Atlantic coasts. The planning and design criteria are given in the previous progress report. Site specific information pertaining to the project area are similar to those eluded in Section 2.4.C., namely, littoral sediment transport characteristics and boundary conditions.

The south jetty cuts off the sediment supply to this region, the littoral transport in front of the seawall is one way from west beach to the South Jetty. The littoral movement in the reverse (southwest) direction carries little material since the groin field

is empty. Installation of offshore breakwater can slow down this mainly one way traffic of sediment movement. This would allow the littoral sediment to deposit on the beach in front of the seawall, and to reduce the growth rate of the Big Reef.

Other nontechnical matters equally important in the processes of choosing offshore breakwater as a shoreline protection method are: (i) general public perception of soft versus hard structures and (ii) boating and recreational concerns, although no persistent hazardous situations have been reported in existing offshore breakwater locations.

3.4.C.4. Nourishment plus updated groin field: As it was pointed out in Chapter 2 (Section 2.4.C.), the price of sand is soaring. The initial investment funds, subject to legislative vote and public referendum, are large. The fast rate of shoreline retreat after nourishment is reported by the mini pilot project at the San Luis Hotel. This provides an incentive to find ways to keep nourished sand on beaches longer.

As to economic considerations, the groin field is already in front of the seawall, to utilize these existing materials for protecting the nourished beach and seawall is natural. In addition, the shoreline and the groin field in front of the seawall have been relatively stable over the years. For these reasons one would logically consider the option of combining beach nourishment with an updated groin field as a means of keeping the sand on the beach longer. Although the beach in front of the seawall is fairly stable, it did not trap the sand to form a beach there.

Recently, the design of a groin system to control the direction of littoral drift is undergoing field test at Miami. This very different concept in the design of a groin system provides a fresh thinking in shoreline protection.

The final judgement on whether an updated groin field with beach nourishment is economically feasible lies with the differences of designs and anticipated results between the existing system and an updated groin system.

3.4.C.5 Nourishment plus offshore detached breakwaters: The motivation of using the existing groin material to establish an offshore detached breakwater system for keeping sand on the beach longer is the same as mentioned in Section 3.4.C.4. The reasoning, however, is a little different. The existing groin system in front of the seawall does not allow sand to accumulate on the beach. Aerial photographs have shown that offshore breakwaters lead to the formation of tombolos or salients. More information about offshore detached breakwaters at work in California may be found in Section 3.5. of this report.

Whether the combination of nourishment and breakwater will be chosen depends on (i) economical analysis, (ii) the tolerance of hard structure to the soft approach for shoreline stabilization, and (iii) the offshore breakwater being less of an eyesore and not segmenting the beach as a groin.

#### 3.4.D. EMERGING NEW TECHNOLOGY APPLICATIONS

Among the eight emerging shoreline protection technologies described in Section 2.5, the dune restoration method does not apply for this case. The beach drain system would not work due to the absence of beach to be drained. Both the dredge material placement technique and the subbottom profile manipulation method have inconclusive results. This leaves only the littoral drift manipulation as a possibility.

The Galveston Bay south jetty cuts off sediment supply at the northeast end of the project area. This renders a one way littoral transport direction toward the northeast. As a result, East Beach and the Big Reef continue to grow and the southwestern portion of the project area experiences a deficiency of sand causing the west beaches to have an erosional trend.

The littoral drift manipulation technique may be employed to slow down the littoral transport in the project area, thus, stabilizing the beach in front of the seawall and slowing down the erosion occurring on west beaches. The test project in Miami which employs T-groin and heavy sand has a similar physical setting as Galveston. A close watch on the progress of this test project may aid the decision process for selection of shore protection methods for Galveston.

#### 3.4.E. COMPARISON AND DISCUSSION AMONG THE OPTIONS

The choice of the plain beach nourishment method should consider the re-nourishment period. An updated groin field would perform better than the existing groin field, although not by much, unless a completely different system aimed to control direction of littoral drift is employed. The offshore detached breakwater has proven its characteristics of protecting as well as widening a beach, but since it is a hard structure, many consider it an eyesore and/or safety hazard.

The combination of soft and hard structures has merit of keeping sand on beaches longer. This choice should be determined by economical feasibility analysis.

The emerging new technologies are still in their infancy. It would not be good for the first demonstration of these to be implemented in Galveston. This area has suffered and needs proven

projects to be employed. It should be encouraged to test some of the new methods, elsewhere, and to initiate new methods of our own at a later date. This would be a necessary condition to elevate the State of Texas to leading position in Coastal Zone Management.



Flanking Erosion at West End of Seawall

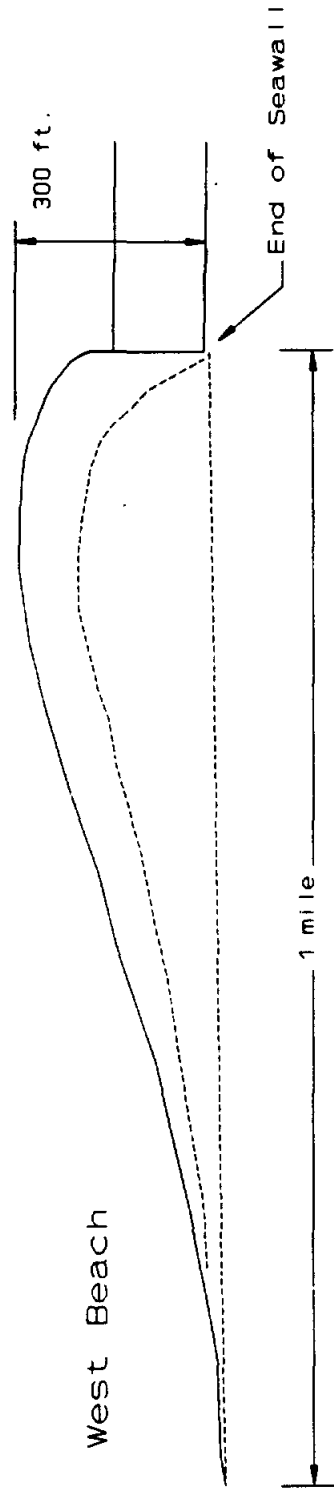

GULF

## SECTION 3.5. WEST END OF GALVESTON SEAWALL

### 3.5.A. THE STATEMENT OF PROBLEM

The erosion at the west end of the Galveston seawall is a typical scene of hard structures parallel to the shoreline. This erosion is known as *flanking*. During severe storms State Highway 3005 will become inundated at the west end of the seawall. Since the highway is so close to the water's edge, citizens on the western portion of Galveston Island fear that they may be isolated from the city if the road is washed out at end of seawall.

### 3.5.B. OBJECTIVE AND SOLUTION

The single objective for this problem area is to stop the flanking at the west end of the seawall. There are a few options available described by the following.

A soft approach to the problem is beach nourishment of the eroded area and prevention of flooding by re-establishing a dune line. Periodic renourishment with high frequency would be anticipated for this method.

A more permanent solution with infrequent and minimum maintenance is to use an offshore detached breakwater. With proper design of top elevation, permeability, length of structure, and distance offshore, a smooth shoreline which would bridge the seawall and natural beach is achievable. Similar situations are found in Santa Monica and Channel Island shorelines in California. Records of the shoreline evolution at these two locations are shown on the next two pages. These pictures provide a clearer view on the offshore detached breakwaters work.

Other options include a formation of a transition shoreline bridging the seawall and natural beach. This transition may consist of a series of groins with reduced lengths stretching out towards the southwest from end of seawall.

# Santa Monica Offshore Detached Breakwater

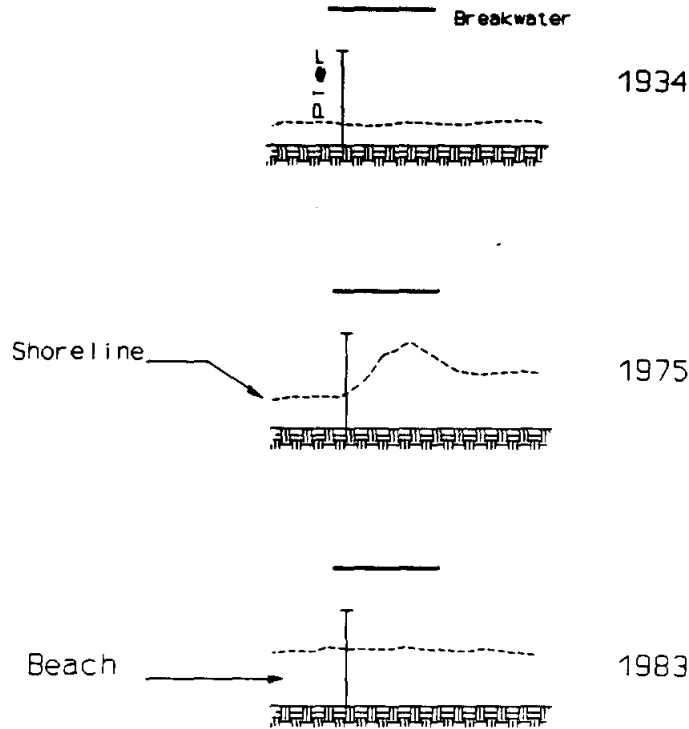

Type: Rubble mound  
Length: 2000 ft.  
Top Elevation: 10 ft. above MLLW  
Distance Offshore: 2000 ft.

In 1934, when the breakwater was constructed, there was insignificant beachfront present. In the 1960's beach width increased to 800 feet wide. Due to lack of maintenance, the breakwater has slumped over the years. In 1983 the breakwater's top elevation was 6 ft. below MLLW, allowing for an increase in wave energy. This increase has since reached an equilibrium state, providing a smooth and stable beachface.

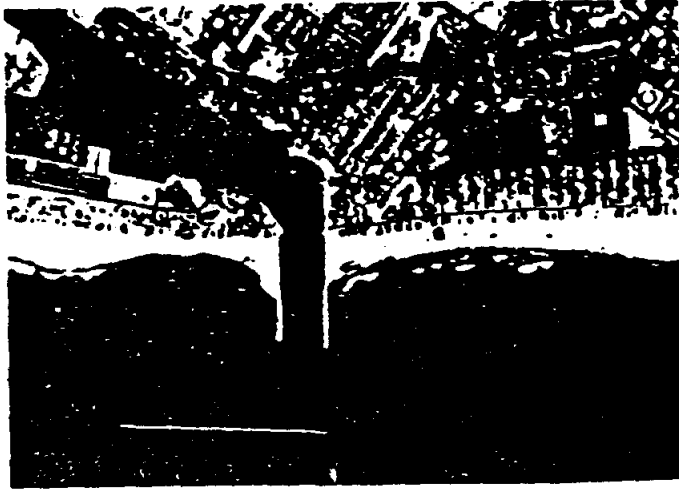

Channel Islands, California

The above two figures are aerial photographs of Channel Island, California. The top picture, taken in 1965, shows the eroded beach behind the breakwater. The lower picture, taken in the 1980's, shows the formation of a tombolo in the lee of the breakwater. The breakwater information follows:

Type: Rubble mound  
Top Elevation: 14 ft. above MLLW  
Length: 2300 ft.  
Location: 30 ft. bottom contour

The Santa Monica and Channel Island breakwaters indicate the possibility of designing an offshore detached breakwater that allows just enough energy to leak in its lee so that a smooth and stable shoreline is produced.

## SECTION 3.6. GALVESTON WEST BEACH

### 3.6.A. THE PROBLEM AND ANALYSIS

The major problem facing Galveston west beach communities is the retreat of shoreline causing flooding of property during storms. The narrowing of the beach face is also a concern. The west beach problems are categorized: failure of beach accretion, presence of low lying areas, and little protection from storm surge. These three problems will be discussed, along with possible solutions, while keeping in mind the interrelationships of each.

The Galveston south jetty and empty groin field along the seawall provides no sediment supply to the west beach region. Also, the shoaling of San Luis Pass and Galveston west bay indicates a sediment sink providing no sediment. These two boundary conditions set the general erosional trend for the west beach.

The west beach of Galveston Island has no appreciable accretion. Large volume of littoral material bypasses the beachfront, continuing downcoast towards San Luis Pass (see San Luis Pass). This has caused numerous problems along the coastline which will be discussed later. Failure of West Beach to build itself, through accretion, has taken away the protective buffer zone that is needed during storm episodes. The *Shore Protection Manual* [5] states that a beachfront buffer zone is one of the best defenses against coastal property loss.

The relationship of upcoast structures, jetties, groins, and seawall, with littoral transport needs to be established so that when these are solved an accretion process can be started at West Beach. While the city has a seawall, the west end is left unprotected from storm surges.

### 3.6.B. OBJECTIVES

The objectives are to stop coastal land loss, prevent flooding of uplands, and widen the beach face for recreational use.

### 3.6.C. OPTIONS FOR ATTAINING OBJECTIVES

3.6.C.1. Beach nourishment with dune restoration: An initial beach restoration project is needed to establish a sound shoreline. However, beach nourishment alone can not stop flooding of upland and coastal land losses. The sea level rises during a hurricane, the nourished beach will be submerged under the stormy sea surface. The storm sea level allows the wave to attack higher coastal land

and is one of the major causes for land loss, flooding, and property damage. The proper remedial method is to build the duneline before a storm attack. During a storm, the dune line takes the brunt assault of storm and absorbs the destructive energy in order to save the land and property behind it. After the storm, the duneline is quickly restored ready for the next storm. A cost effective with minimal environmental impact method for dune restoration is proposed by Wang called *Nature Assisted Dune Restoration (NADR)* [6] found in Section 6 of the previous progress report. The raising of land areas by dune restoration, and the implementation of a buffer zone through beach nourishment will stabilize the shoreline and reduce the storm surge damage on coastal property and land.

3.6.C.2. Offshore detached breakwater with dune restoration: The offshore detached breakwater does not add material to the already sediment deficient region, rather, it slows down littoral sediment transport movement, thus slowing down the erosional trend. During storms the structure would trip waves to break offshore further increasing its erosion resistance. An offshore breakwater, however, cannot replace the function of a dune system. The combined use of a breakwater and dune restoration offers a better solution for the problems facing west end beaches.

#### 3.6.D. IMPLEMENTATION STRATEGY

The not yet fully developed western beaches may not have the financial strength to carry out the suggested erosion control measures all at once. It may then be more realistic to implement low cost dune restoration first, while working up to a full implementation of a complete shore protection plan.

# San Luis Pass

57

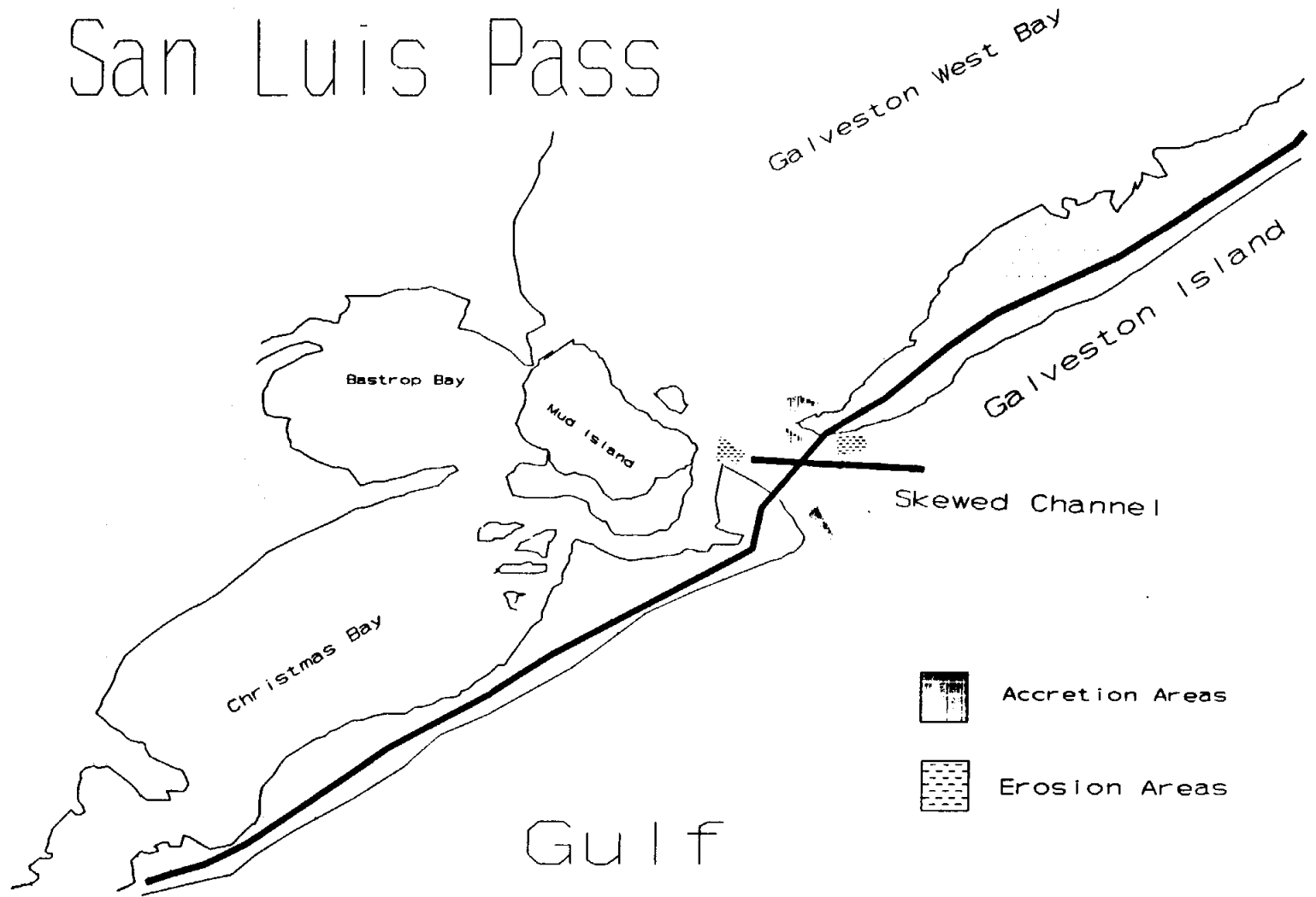

## SECTION 3.7. SAN LUIS PASS

### 3.7.A. THE PROBLEM AND ANALYSIS

The recent trend occurring along the western extreme of Galveston Island, San Luis Pass, is that of unwanted massive accretion and erosion along the Pass. These in turn have created the re-alignment of the channel which has skewed toward the northwest direction. It is shown on the San Luis Pass map.

It is observable, the bridge which spans the inlet has a beachfront below; the channel has become narrower and deeper. A stronger tidal current is thus produced and it undermines the bridge piers and erode the shoreline along Mud Island.

The nearby Galveston West Bay area have been filling with sand, circulation of bay waters have been interrupted and the healthiness of bay related businesses have suffered. Solutions to the massive deposit of littoral materials need to be found.

### 3.7.B. OBJECTIVE

The multiple objectives should include:

- \* Stabilize the skewed channel which runs through the Pass.
- \* Revive the smothered bays by restoring the flashing and circulation of the inlet-bay system at Sand Luis pass.
- \* Control the sediment movement along the shoreline to reduce the rapid siltation of the inlet-bay areas and the erosional trend at the Gulf shore near the Pass.

### 3.7.C. APPROACHES TOWARD ATTAINING OBJECTIVES

The San Luis Pass serves as a vital link which connects Galveston West Bay, Bastrop Bay, Christmas Bay and Chocolate Bay. The circulation and flashing pattern of this inlet-bay system is directly related to the well being of the ecosystem in that region. Therefore, a comprehensive system approach toward a solution is recommended. A report similar to the study of Rollover Pass and vicinity is called for [3]. The study should include but not limited to the following.

- \* Effects of upcoast and downcoast characteristics on the inlet-bay system.
- \* Impact of man made shoreline protection measures on the inlet-bay system.



- \* If sand removal from the inlet-bay system is necessary for revive the choked system, then, this removal should be taken into account for replenishment supplies for beach nourishment projects along the seawall and Galveston west beach.

### SECTION 3.8. TEXAS CITY DIKE

The Texas City dike opens to a fetch length of approximately 30 miles in the north northeast direction. A northeaster with a wind speed of 50 miles per hour blowing for 3 hours could produce waves in excess of 5 feet high. These waves break against the dike may cause scour at the structure toe as well as dislodgment of armoring units. It seems prudent to send divers to inspect the foundation before any preliminary solutions can be formulated. Once the nature of damages is known, maintenance and repair procedures can then be suggested.

The shoreline between the Dollar point and Tide Gate has the same orientation as the Texas City Dike, therefore it subjects to similar wave actions. Shoreline condition there may need more attention than the Texas City Dike.

### SECTION 3.9. GALVESTON BAY SHORELINE EROSION

#### 3.9.A. THE PROBLEM

The major problems facing the shorelines of Galveston Bay is erosion in shallow waters.

#### 3.9.B. SOLUTIONS

Solutions to shoreline erosion in Galveston Bay consists of different employments of material to dampen waves. Vegetation is a natural dampener. As a wave approaches shallow water areas with vegetation (usually grasses) it dissipates energy. Another type of dampening can be employed by man-made materials. The use of man-made materials would serve better than vegetation in that the energy can be calculated and dampening can be implemented to varying degrees. The use of structures with specific shapes and characteristics can be refined to control the energy that waves will possess.

### SECTION 3.10. DATA REQUIREMENTS AND ACQUISITION

Data acquisition is expensive and time consuming. At the planning and preliminary design stages, it is adequate for engineers to use available historical data. For long term considerations, a plan to collect and establish a data base for Texas Coastal Zone Management and Galveston County is very much needed.

### SECTION 3.11. CONCLUSIONS

The problem area on the shoreline of Galveston County are identified. Analyses of the problem areas are done in the light of the physical environment and littoral characteristics of Galveston coast line. Optional methods for protecting the shoreline in each problem area are suggested. The selection process for a protection method in a problem area begins with the economic analysis. The final decision should be weighed with technical merit, environmental concerns and economical soundness.

## REFERENCES

1. US Army Corps of Engineers (1984) "Galveston county Shore Erosion study. Feasibility Report on Beach Erosion control; Vol. 2: Gulf Shoreline study Site Report," US Army District, Corps of Engineers, Galveston, Texas. p. 185
2. Morton, R.A. (1975) "Shoreline changes Between Sabine Pass and Bolivar Roads: An Analysis of Historical Changes of the Texas Gulf Shoreline." Geological Circular 75-6, Bureau of economic Geology, the University of Texas at Austin, Austin, Texas.
3. Wang, Y.H. (1989) "Preliminary Designs of Improvements at Rollover Pass and Vicinity, Bolivar Peninsula, Texas." Technical Report, MASE Department, Texas A&M University at Galveston, p.156
4. Giardino, J.R., Bednarz, R.S., Bryant, J.T. (1987) "Nourishment of San Luis Beach, Galveston, Texas: An Assessment of the Impact." Coastal Sediments '87, pp. 1145-1157
5. US Army Corps of Engineers (1984), "Shore Protection Manual" Coastal Engineering Research Center, 2 Volumes
6. Wang, Y.H. (1991) "Nature-Assisted Dune Restoration" Proceedings, Coastal Zone '91, Long Beach, California

**CHAPTER 4**  
**MODIFICATION AND LAYOUT**  
**OF**  
**GALVESTON GROIN FIELD**

## TABLE OF CONTENTS FOR CHAPTER 4

SECTION 4.1.	Introduction.....	64
SECTION 4.2.	Analysis of the Existing Galveston Groin Field...	64
SECTION 4.3.	Spacing Reduction of the Groin Field.....	64
SECTION 4.4.	Concept of Modification.....	65
SECTION 4.5.	The Modified Groin System.....	65
SECTION 4.6.	Concluding Remarks.....	66

## SECTION 4.1. INTRODUCTION

### 4.1.A. MOTIVATION

The project of beach nourishment in front of the Galveston Seawall calls for 15 to 20 million dollars. It is logical to explore avenues through which more economical ways to retain a beach in front of the seawall; the implementations can be scheduled in stages.

### 4.1.B. SCOPE

The work here is to utilize the existing groin field and modify it in a way that the new groin system can perform more effectively for retaining sand than the existing groin field. To achieve this goal, the existing groin field is analyzed and a new concept is introduced for the modification. A general layout is provided for cost estimation purposes.

## SECTION 4.2. ANALYSIS OF THE EXISTING GALVESTON GROIN FIELD

According to the Corps of Engineers' 1984 reports, waves in the Galveston area are mostly from the southeast and south directions (56% are from the southeast).

An analysis of the littoral transport directions indicated that sand placed between the existing groin elements will move in reversed directions depending on whether the incoming wave is from the southeast or the south.

- \* The placed sand between the groin elements will move in the southwest direction toward San Luis Pass when the groin field is exposed to southeastern waves. Figure 1 shows this general trend.
- \* The placed sand between the groin elements will move in the northeast direction towards Stewart Beach when the groin field is exposed to southern waves. Figure 2 shows this general trend.

These sand movements will result in the loss of placed sand between the existing groins.

## SECTION 4.3. REDUCTION OF SPACING BETWEEN GROIN ELEMENTS

The spacing between groin elements in front of the Galveston Seawall is mostly around 1500 feet with a few shorter ones of 900 feet. Recent aerial photographs indicate that the short (900 feet) spacing has a marginal beach while the longer spans don't. This

observation motivates the study of reducing the span between the groin elements.

A 500-foot long groin is inserted into all the long spans. The littoral transport direction is then determined. The analysis showed the similar trends to the existing groin field.

- \* The placed sand between groin elements will move in the southwestern direction towards San Luis Pass when the groin field is exposed to southeastern waves. However, there are two exceptions between groin numbers 6,7 and 2,3. Figure 3 indicates this trend.
- \* The placed sand between groin elements will move in the northeastern direction toward Stewart Beach when the groin system is exposed to southern waves. Figure 4 illustrates this general trend.
- \* The new groin construction is estimated to be 6000 feet.

As shown by these figures, placement of intermediate groins between the long spans gives results similar to the existing groin system, although transport rates differ.

#### SECTION 4.4. CONCEPT OF MODIFICATION

Along a sandy straight shoreline, for a given dominate incoming wave, the littoral transport direction is determined. The concept introduced here is that for a given incoming wave, the littoral transport direction can be manipulated to reverse its normal transport direction and the transport rate can also be reduced or increased. This concept is illustrated in Figure 5.

#### SECTION 4.5. THE MODIFIED GROIN SYSTEM

The concept introduced in Section 4 is utilized to mainly slow down the sand movement in the southeast direction; illustrated in Figures 1 and 3. Considerations are also given to incorporate the littoral transport due to southern waves (Figures 2 and 4) and waves from directions other than southeast and south directions. Notice the slanted T and L additions which are optimized using incoming wave angles. A preliminary layout of the modified groin system is presented in Figure 6.

The highlights in Figure 6 are listed below:

- \* The net direction of littoral transport are kept to a minimum compared to Figure 1 through 4.
- \* The length of new groin construction is 4285 feet compared to the length required in Section 3 of over 6000 feet.
- \* The waterline marks the expected size and shape of the sand beach between the groin elements.
- \* The slanted T-shape and L-shape groins are used to retain the placed sand within the groin elements.

#### SECTION 4.6. CONCLUDING REMARKS

From this analysis, the following conclusions are summarized.

- \* Placement of sand within the existing groin field results in sand movement towards San Luis Pass with southeast wave direction.
- \* Placement of sand within a groin system with shorter spacings (groin every 900 feet or less) also results in sand movement towards San Luis Pass during southeast waves.
- \* Placement of sand within the modification of the existing groin system (Fig.6) shows a reversal, which helps keep sand in place during southeast waves.

The layout of the modified groin system needs a nourishment of sand from an external source, it is not meant to be used to collect sand but to retain the placed sand between groin elements. If the layout is adopted, the refined calculation must be done on: (1) the orientation of the Ts and Ls of the groin tips, (2) the length of the existing groins and the groin tips, (3) more incoming waves other than southeast and south directions need to be analyzed for transport direction and intensity.

Since this report examines the situation based on wave direction alone, the final design of this groin system should include refraction analysis, taking into account breaker height and other conditions.



Figure 1 Existing Groin System with Southeast Waves

67

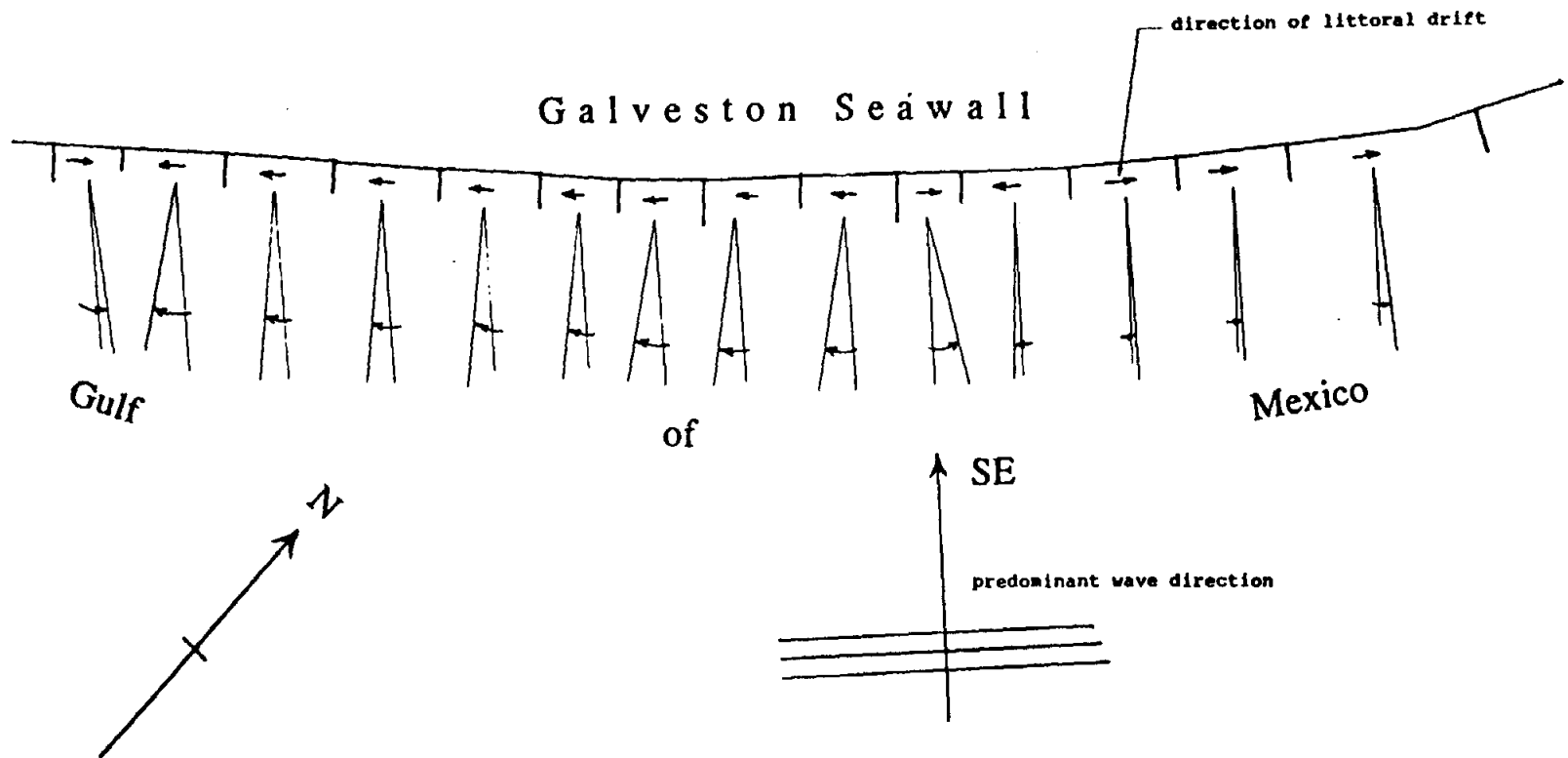

Figure 2 Existing Groin System with South Waves

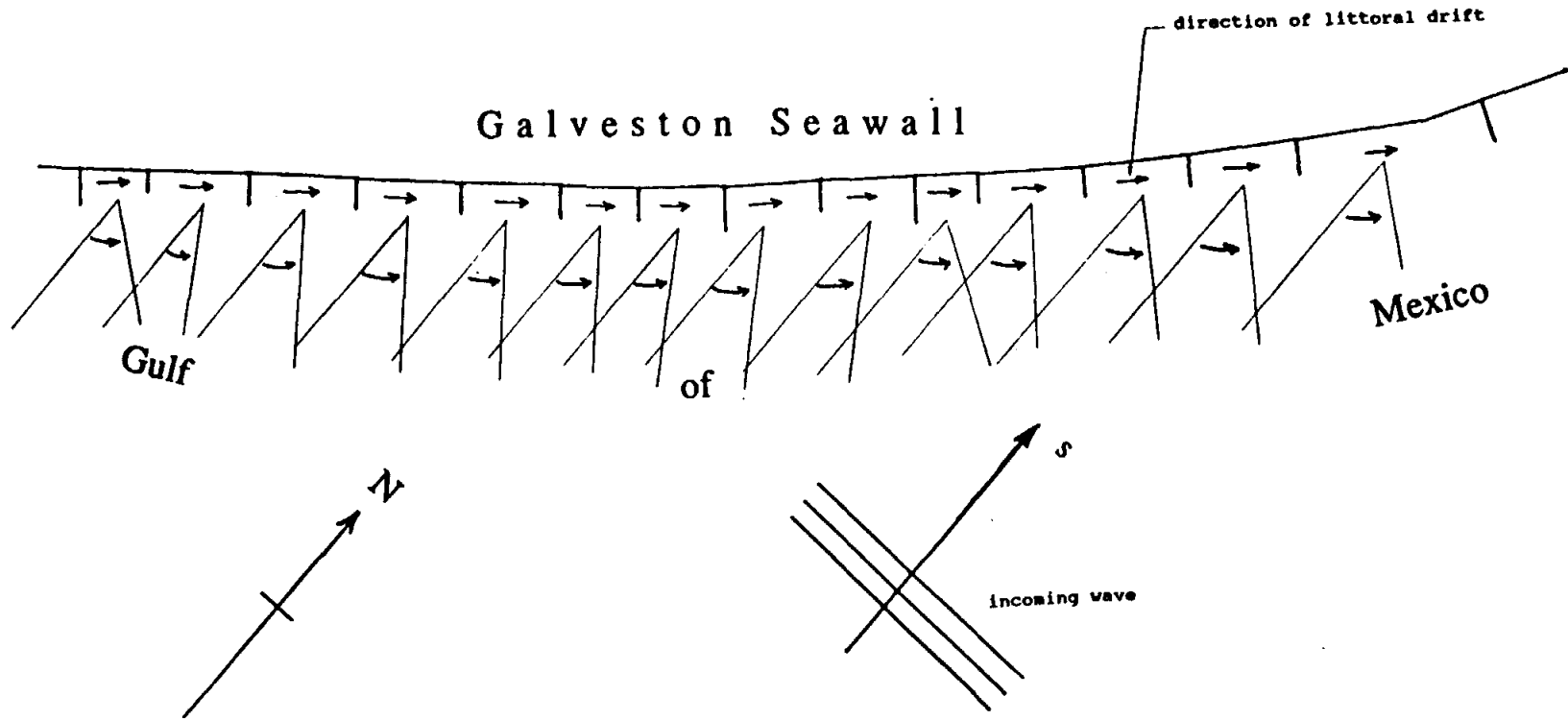

Figure 3 Short Span Groin System with Southeast Waves

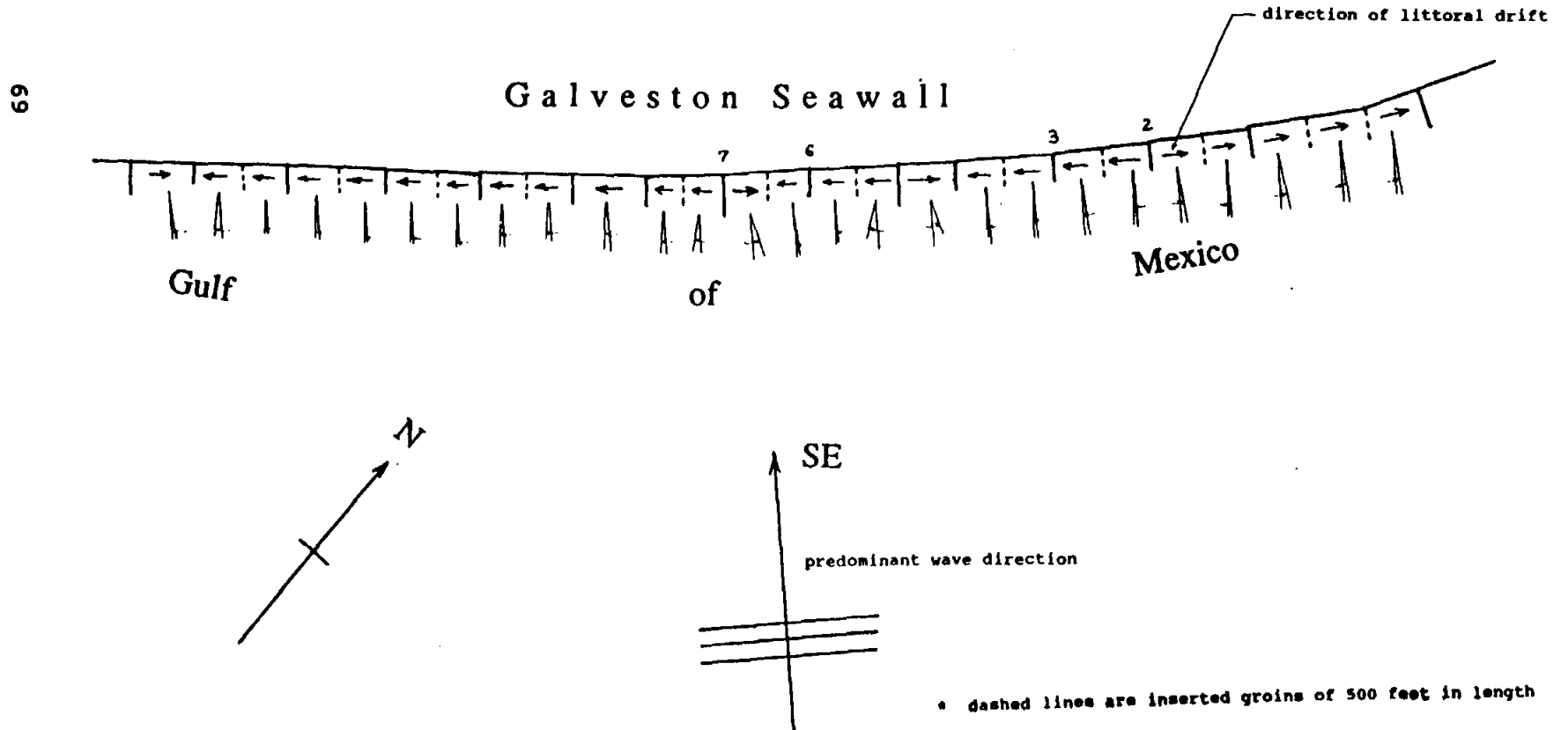
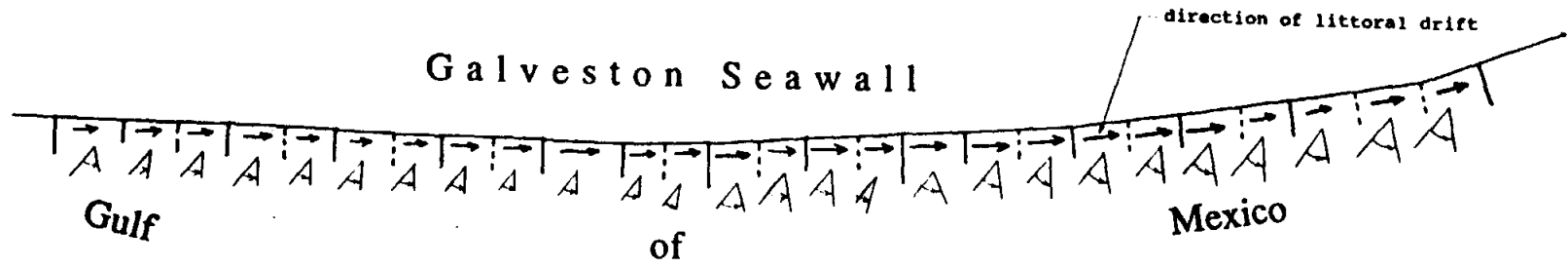
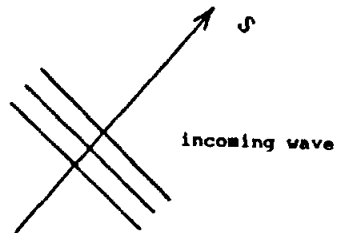
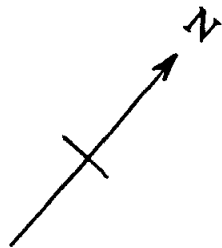

Figure 4 Short Span Groin System with South Waves



70



\* dashed lines are inserted groins of 500 feet in length

# Effect of Groin Orientation on Net Drift Direction

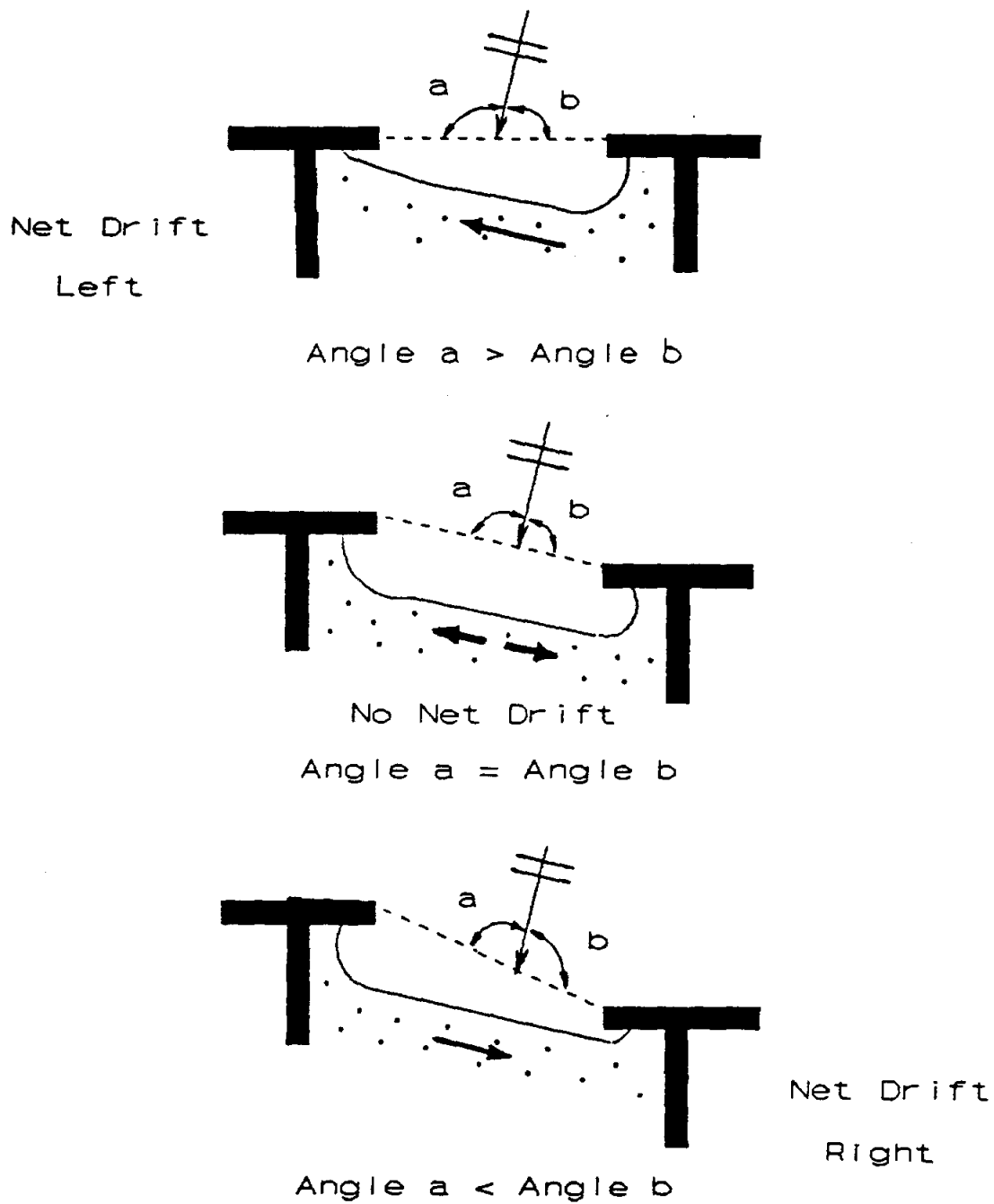
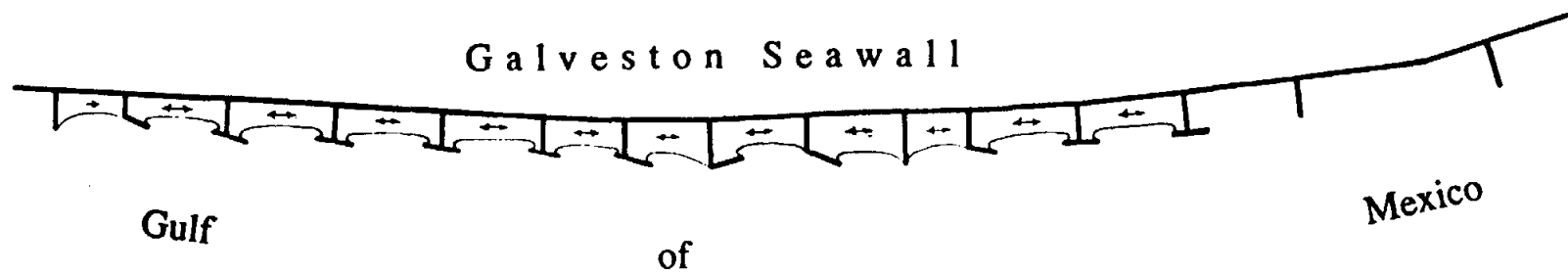
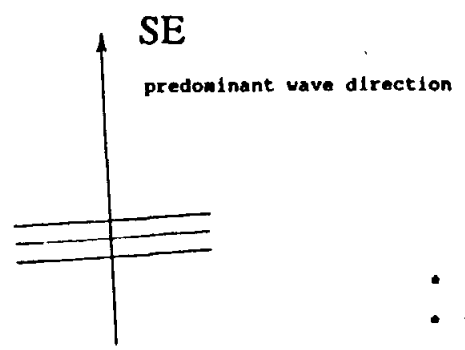
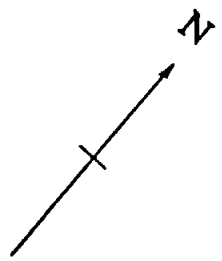

Figure 5

Figure 6 General layout of modified groin system



72



- openings between groin elements are 900 feet
- $T_s$  and  $L_s$  are slanted with varying angles

## CHAPTER 5

### CONCLUDING REMARKS AND RECOMMENDATION FOR FUTURE WORK

#### SECTION 5.1. CONCLUDING REMARKS

In non-technical terms, shoreline problems in Galveston County may be characterized by the following.

- \* **The Most Visible Project:** The restoration of beaches in front of Galveston Seawall.
- \* **The Worst Eroded Shoreline Sites:** The west-end of Galveston Seawall, Ferry Landing road, and Rollover Pass.
- \* **The Most Economical Project:** The project that will yield the highest cost/benefit ratio is the "Dune Restoration on Galveston West Beach".
- \* **The Most Innovative Project:** Modification of the Galveston groin field.
- \* **Can Propel to Eminence:** The projects that can propel the shoreline protection program of Texas to national and international eminence are: (i) dune restoration on Galveston West Beach, and (ii) the modification of the Galveston groin field.

It is hoped that these non-technical characterizations of Galveston County's shoreline problems would help decision makers to establish the priority for action according to their own value system.

#### SECTION 5.2. RECOMMENDATION FOR FUTURE WORK

The work in the immediate future should be preparation for the project(s) to be put into action. Integral information needs to be collected for any project(s) to be properly designed and successfully executed in their finer analysis. These should include but are not limited to the following.

- \* **A Center for Texas Beaches and Shores (CTBS):** A CTBS is to be established at the Galveston campus, TAMU, so that, the following proposed work and works in the future can be better handled.

- \* **A laboratory model Study:** The proposed Galveston groin field modification in Chapter 4 has the merit of retaining sand for the newly nourished beach. It would be appropriate at this time to carry out a model study in the laboratory to show that how the Ts and Ls of the groin tips work.
- \* **Monitoring the variability of beach profiles:** The length of the beach profile should be from the duneline to the sea bottom beyond the last seaward offshore bar. These profiles are necessary for proper determination of erosion/accretion rates as well as engineering designs.
- \* **Sand Source investigations:** This should include the composition, grain size, size distribution, borrow sites and quantity available of the sand to be placed in front of the Galveston Seawall.
- \* **Wave and environmental information:** The newest wave data applicable to Galveston area was produced in 1989 by the Coastal Engineering Research Center in Mississippi using the Gulf of Mexico hindcast method. Therefore, it would be more desirable to collect wave data in the nearshore region and in the breaker zone fronting Galveston Island.



APPENDIX A  
HOLMBERG TECHNOLOGIES  
AND  
COMMENTS BY WANG

**HOLMBERG TECHNOLOGIES**

John M. Arrington  
7025 Kopman  
Houston, Texas 77061  
1-713-649-4795 1-409-737-26  
**TEXAS BEACH RESTORATION**

**GALVESTON SHORELINE  
RESTORATION AND EXPANSION  
PILOT PROJECTS**

***UNDERCURRENT STABILIZATION  
ANCHOR SYSTEMS***

---

COMMUNITY SERIES  
SEPTEMBER 1, 1990

Undercurrent Stabilizer System™  
Undercurrent Stabilization Anchoring System™

## **RESTABILIZATION OF GALVESTON'S COASTAL SHORELINE UTILIZING DICK HOLMBERG'S UNDERCURRENT STABILIZER ANCHOR SYSTEMS™**

**Executive Summary** The channelization of the rivers that empty into the Gulf has cut off both major sources of new sand from Galveston's coastal beach sand budget. The deep dredging of navigation channels has forced the suspended inland erosion materials in rivers to bypass the beaches and deposit of the near-offshore bottom. The removal of the Gulf's shallow natural delta regions that once formed at the mouths of rivers also had long term ramifications. Resulting unnatural nearshore current patterns now stop near-offshore bottom sand from being fed into the beach budget by natural processes during storms.

Without these natural delta region "speed-bumps" regulating their speed, the Gulf's parallel nearshore currents are able to attain destructive velocities during storms. They are now able to scour great quantities of sand from Galveston's beaches and nearshore bottoms. During storms, these sand laden currents are being diverted offshore by the dredged channels and protruding structures, taking what is left of Galveston's beaches with them. Like the river sediment, this sand is also being depositing on the near-offshore bottoms.

The high quality sand on Galveston's near-offshore bottom is a plentiful source of new sand for its beaches and nearshores. The "Holmberg Method" of Coastal Restabilization technologically works with the forces of nature to re-introduce the natural processes which will once again move this new sand into Galveston's beach budget. It also prevents future losses of existing beach sand.

Strategically placed "artificial delta regions" will be constructed along the Galveston coast to duplicate the regulatory and feeder functions that were once provided by natural deltas and shoals. They will reduce nearshore barrier current speeds, prevent scouring and eliminate the offshore diversion of beach sand.

The artificial deltas will act as storage/feeder areas that load with transported sand during storms and then release sand again after the storm. This sand is therefore retained in the beach budget to be shared by all inter-dependent beaches in this coastal cell. The delta regions will continue to elevate and widen indefinitely, expanding and elevating their inter-related beaches with them.

A minimum of two (optimally four) substantial pilot Undercurrent Stabilization Anchor Systems need to be constructed to initiate a broad scale program of bringing natural sand accretion processes back to the Galveston coastal area. The completed process of expanding and restoring its beaches to self-protective (net gain) modes will take approximately two to five years.

The pilot systems will begin the process of neutralizing the diversionary negative influence of Rollover Pass, the Houston Ship Channel and San Luis Pass. They will also begin countering the impact of the existing anti-nature type armoring. The program will be implemented without disturbing navigational interests or tourism.

These highly visible anchoring pilot projects will publicly demonstrate the cost and environmental effectiveness of the nature based accretion technology alternative. They have been designed to unobtrusively blend into the beach environment until they become buried under accreting sand.

The pilot systems will provide the geomorphic and scientific data necessary to complete the broad scale Coastal Restabilization program for the Galveston region. The viewable results of the pilots will solidify the metro-Galveston and Texas population behind this program to permanently restore and preserve its Gulf coast heritage. The completed Coastal Restabilization program will be permanent and environmentally sensitive, yet cost significantly less than temporary armament or sand nourishment.

# HOLMBERG TECHNOLOGIES



Dick Holmberg, Founder  
P.O. Box 100, Whitehall, MI 49461  
616-894-5093

Mr. Pat Hallisey, Executive Director  
Galveston County Beach Park Board of Trustees  
613 19th Street  
Galveston, TX 77550

August 10, 1990

**RE: Restabilization of the Galveston County Coastline.**

Dear Mr. Hallisey,

This letter is in response to the correspondence and materials sent to me over the last 6 months in regard to the implementation of a permanent shoreline restoration program for the Galveston County coastal shoreline. I have completed a thorough analysis of the materials submitted, and the related historical documentation available to me. I am confident that this region can be restored to a net expansion mode by reintroducing certain natural processes back into your shorelines. The enclosed historical summary of Galveston's coastal changes and the information on artificial delta formation should help you understand how this will be accomplished.

The need for a minimum of two pilot anchor sites has been determined. One anchor site will be located on the Bolivar Peninsula, approximately 2 1/2 miles east (north) of Rollover Pass. The second anchor site would be constructed in the Bermuda Beach Spanish Grant area, approximately 16 miles west (south) of the south jettie of Galveston Harbor.

Substantial pilot Undercurrent Stabilization Anchor Systems must be utilized to initiate the program of bringing natural sand accretion processes back to the Galveston coastal area. These pilot Anchor Systems are designed to begin the process of neutralizing the diversionary negative influence of Rollover Pass, the Houston Ship Channel, San Luis Pass and the anti-nature type armoring that has been constructed along your shoreline. These initial Systems will be expanded upon after the initial pilot period.

Mr. Pat Hallisey

August 10, 1990

Page two

You have two pilot system design and construct options:

- 1) Two demonstration size Undercurrent Stabilizer Anchor Systems at a cost of \$749,000 each for a total of \$1,498,000 (Each will have to be extended and reinforced later), or
- 2) Two full size Anchor Systems at a cost of \$1,245,000 each for a total of \$2,490,000. (They will not have to be extended or reinforced later.)

The number of Stabilization Systems that will be constructed to complete the full Galveston area program will be determined from data acquired during the pilot period. The complete program will be permanent, will cost significantly less than temporary armament or sand replenishment, and won't interfere with deep water navigational interests.

The restabilization of Galveston's coastal shoreline has to be targeted as the area's first priority. It will generate enormous future local, state and federal savings. The problems within the West Galveston Bay are also curable, but they cannot be properly engaged until the pilot coastal program is under way.

Thank you for your help and concern regarding our coastal shorelines and their related economies. It is time our nation brings "offense and restoration" to the forefront in our ongoing battle to stop our coastal destruction.

Sincerely

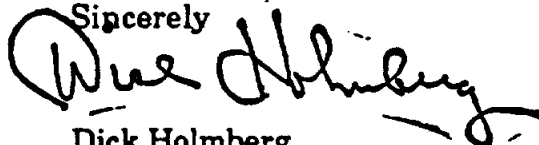

Dick Holmberg  
Chairman and Founder  
Holmberg Technologies

DH/mrc  
Encl.

**SIMPLIFIED LINE GRAPHIC  
PILOT COASTAL RESTABILIZATION ANCHOR SYSTEM™ #1  
BOLIVAR PENINSULA**

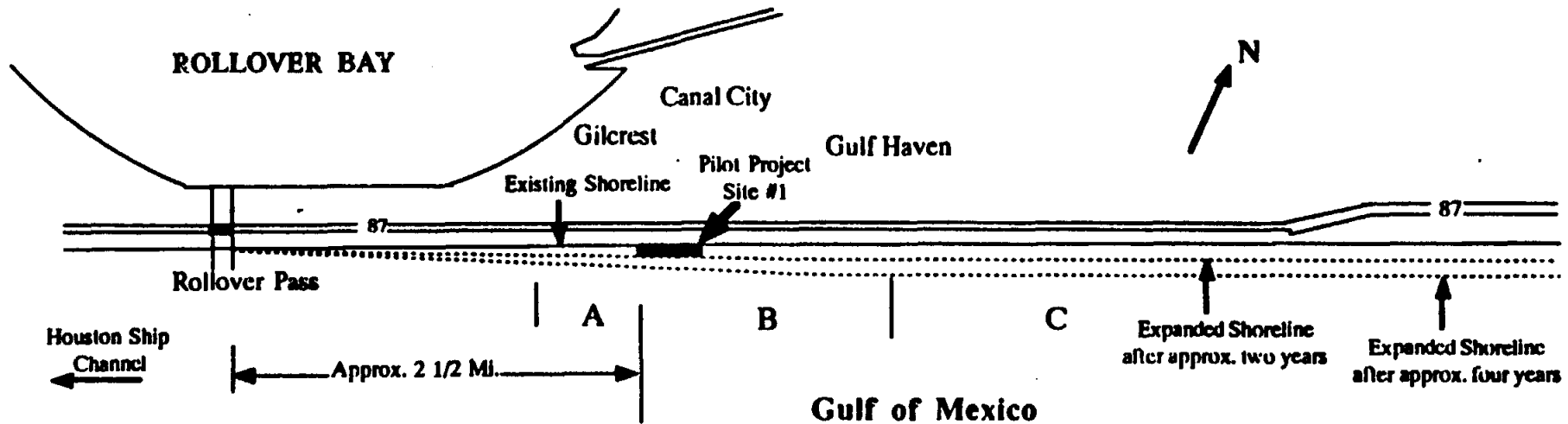

**Area A will not experience as much accretion as B or C due to its proximity to Rollover Pass channel.  
Areas B & C will experience approximately the same rate of growth.**

The deep dredging of Houston Ship Channel destroyed the shallow delta region and shoals that naturally formed at its mouth. Without the speed regulating controls provided by the original natural delta, storms are able to generate high velocity parallel currents which continually scour sand out of the nearshore bottoms and deplete Galveston's beaches.

The two pilot Restabilization Anchor System are designed to create artificial delta regions on both sides of the channel which will duplicate the speed regulating function that the destroyed natural delta region once provided. The System will help nature to expand and elevate beaches to a self-protective and natural state. It will have a widespread positive influence on related shorelines in both directions.

The pilot Restabilization Anchor System for the Bolivar Peninsula is designed to begin the process of neutralizing the diversionary negative influence of Rollover Pass, the Houston Ship Channel and Sabine Pass on this inter-related stretch of shoreline. The initial System will be expanded upon after the initial pilot period.

It will create a series of controlled uplifts to reduce the unnatural current and wave velocities that have developed in the nearshore area as a result of the channelization of this coast. This reduction during storm events will induce the sand suspended in them to be deposited in the form of an artificial delta region centered at the above project site. By neutralizing the barrier currents, it will also allow sand to once again move into the sand budget from the offshore bottom. The newly formed artificial delta region will act as a storage/feeder region, accumulating new sand and distributing it to the intra-related beaches within the Houston Ship Channel to Sabine Pass coastal cell.

Shortly after installation new sandbars will form seaward of the System's submerged structures. These new bars are the sides of the relocated nearshore current troughs. This initial localized change in current orientation will spread up and down the inter-related shoreline. Once this occurs, natural processes will continue to elevate and expand the nearshore bottom and landward beach profile indefinitely.

**HOLMBERG TECHNOLOGIES**

# SIMPLIFIED LINE GRAPHIC PILOT COASTAL RESTABILIZATION ANCHOR SYSTEM™ #2 GALVESTON ISLAND

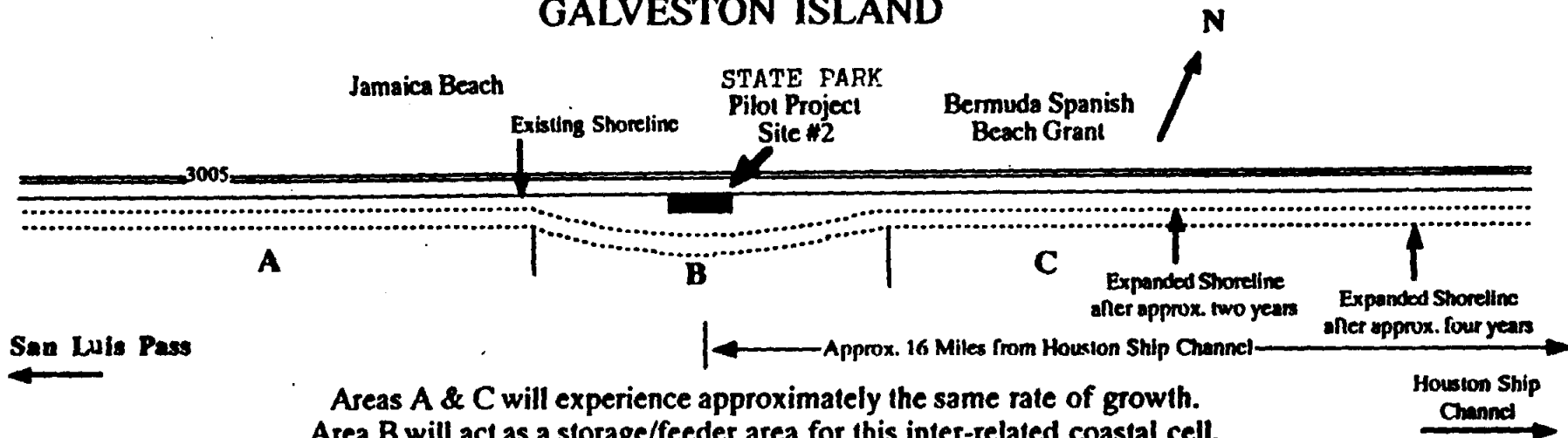

**Areas A & C will experience approximately the same rate of growth.**  
**Area B will act as a storage/feeder area for this inter-related coastal cell,**  
**and will experience somewhat more expansion until the whole shoreline comes into balance.**

The Galveston Island pilot System will begin the process of restabilizing the nearshore zone southwest of the Houston Ship Channel. Like the pilot site on the Bolivar Peninsula, this newly formed artificial delta region will act as a storage/feeder region for the San Luis Pass to Houston Ship Channel coastal cell.

The size of the artificial delta regions will expand as they load during storms, then shrink as they feed their adjacent shorelines after the events. Beaches on both sides will widen and elevate. Storm seasons exaggerate the growth cycle and calm seasons exaggerate the feeder cycle. The rate of shoreline expansion and nearshore shallowing is influenced by long term weather cycles, the more natural energy available, the faster the restabilization process.

The loading and discharging cycles will continue to expand and balance the intra-related shoreline over an extended period of years. When the restabilized beaches widen and elevate sufficiently above the water line, the sand dries and wind begins to move it landward. The landward structures become completely buried in accreting sand. The beach profile becomes flatter as its new elevation increases.

The dry sand that continues to build on the beach will have to be properly managed by revegetation to control dune migration landward of the beach. This will likely begin in the third or fourth year.

The increased nearshore bottom elevation of a restabilized shoreline causes waves to break much further offshore than they did prior to the installation. The elevated beaches, foredune areas, related wildlife habitats and buildings will no longer be subject to full frontal wave attack.

Even during cataclysmic events such as hurricanes, damages will be dramatically reduced by the nearshore shallowing and widened beaches. Although rare major storm events may expose the top few inches of the System's structures, they will once again become re-buried as the induced delta reforms after the event. A dramatic net increase in the sector's sand budget may even result from such events.

## **STAND-ALONE UNDERCURRENT STABILIZATION™**

Undercurrent Stabilizer Systems were designed and developed to be utilized on a stand-alone basis, without mechanical beach nourishment. Instead of using detrimental mechanical means, Undercurrent Stabilization assists *nature* in re-establishing a pro-gradation profile to a shoreline that has suffered long term net sand budget deficits.

Sand accretion is induced without impacting adjacent stretches of beach. To the contrary, artificial deltas also induce upcurrent and downcurrent accretion. Once the System reaches maturity, its intra-related area sand budget maintains a controlled equilibrium indefinitely.

Several stand-alone pilot Undercurrent Stabilizer Anchor Systems are generally installed on a project shoreline prior to the completion of the area wide system. Anchor Systems are utilized to analyze the accretion characteristics of the inter-related shoreline project area. In most coastal regions, induced accretion rates are sufficient enough to provide a steady increase in recreational and protective beach area. When there is enough time available (two to four years) the stand-alone alternative is by far the most cost effective and environmentally compatible.

## **STABILIZATION PLUS A ONE TIME BEACH NOURISHMENT**

In situations where time is absolutely critical, Undercurrent Stabilizers can be utilized in conjunction with a one time (full or partial) mechanical renourishment. Also, in rare cases where the induced accretion vs offshore diversionary loss ratio approaches equilibrium (1/1), a one time partial nourishment will accomplish an immediate and permanent expansion of critical beach areas.

When used in conjunction with one mechanical nourishment, the Stabilizers are extended a distance offshore beyond the outside edge of the nourishment zone. An artificial delta region will form seaward of the renourishment area. Induced accretion will continue to elevate the bottom profile seaward of the nourishment, future losses will be eliminated and additional beach area will be gained landward of the water's edge.

Undercurrent Stabilization plus one mechanical nourishment may be the only ecologically and economically viable option left to a community *under certain existing political situations*. If a community has no other recourse, using Stabilizers as a foundation to a mechanical nourishment will help make an otherwise temporary program more environmentally sensitive and eliminate the need for future renourishments. The cost vs benefit ratio makes it a highly cost-effective alternative to creating an unnecessary dependency on continual renourishments.

## **UNDERCURRENT STABILIZERS™ vs GROINS**

**GROINS** The basic design and methods of utilization of groin type structures have changed very little since their introduction to our coastal shorelines over a century ago. The traditional elevated groin structure is constructed of piled rocks, piled riprap, wood, steel, concrete and other materials. They do not ecologically or scientifically address the dynamic principles of aquatic motion or coastal geomorphology. Instead, they are constructed to create a mass sufficient to forcefully trap a certain amount of sediment in flow in the nearshore currents and waves.



*Although groins may give temporary protection to the property directly behind them, they have been proven to adversely impact their inter-dependent shoreline. Despite the differences in their final appearance, all groins (and other anti-nature armor alternatives) are based upon an adversarial relationship with natural shoreline processes. They are crude structures which reflect wave and current energy seaward and increase nearshore turbulence. This erodes the sand in front of them, resulting in deeper water, higher energy nearshore wave climates and the further magnification of unnaturally destructive parallel currents. They result in additional nearshore sediment being diverted offshore and out of the local beach sand budget.*

**UNDERCURRENT STABILIZATION™** In direct contrast to groins, artificial delta regions were developed to work *with nature* to neutralize the wide-scale offshore diversion of beach sand by dredged navigation channels and other anti-nature type water works. This is accomplished by assisting nature to reestablish control over aberrant nearshore zone sediment flow patterns. Artificial delta regions replace the speed control and feeder functions of the natural deltas that were destroyed by environmentally insensitive navigation and coastal engineering practices.

Our understanding of coastal sediment transport processes and the principles of aquatic motion has been dramatically increased by the efforts of an unlettered coastal pioneer named Dick Holmberg. He discovered the existence of destructive and unnatural nearshore currents over twenty five years ago by placing himself in special protective gear for first hand study of storm processes in nearshore areas.

Although Holmberg's patented Undercurrent Stabilizer Systems™ (artificial delta regions) are constructed at near-right angles to the shore, that is where the similarity to their predecessor groins ends. Undercurrent Stabilizers utilize the energy in nearshore currents and waves, instead of fighting it. Comparing Stabilizers to groins is equivalent to comparing a board to the wing of a jet. By analogy, the Wright Brothers were able to achieve very limited and dangerous flight without a total comprehension of aerodynamic principles. But stable and safe flight wasn't successfully achieved until after those principles were fully understood and incorporated into aircraft designs.

The scientific principles incorporated into Undercurrent Stabilizers are the reverse of aerodynamic principles which lead to air being redirected downward to give lift to a moving airfoil. Moving nearshore currents and waves are repeatedly deflected upward without creating a seaward change in their directional motion. Their velocities are reduced as they pass through a series of these dynamic and ultra-low profile "speed-bumps." This induces the sand in flow to drop out of suspension and attach to the beach (accrete). Neutralizing the unnatural barrier currents also allows new sand to once again be moved in from the offshore bottom by natural storm processes.

*The sand that accretes to form an artificial delta region would have otherwise been diverted offshore by the navigation channels and structures that the sand laden currents encounter. It would have been lost to the whole coastal shoreline's sand budget indefinitely. Instead, the newly formed artificial delta region acts as a storage/feeder region, accumulating new sand and distributing it to the intra-related beaches within its coastal cell. Sand is thus added to and retained within the sand budget, to be shared by all the inter-dependent coastal beaches along great distances of shoreline.*

## **GEOMORPHOLOGY OF GALVESTON'S COASTAL BEACHES**

Prior to human interference with the Galveston area's coastline sediment transport systems, inland erosion materials and offshore bottom sand was continually being added to its coastal sand budgets through natural processes. Galveston's unaltered sedimentary shorelines enjoyed an extended period of net gain. Its healthy, natural sandy beaches tended to grow, rather than wash away and its shallow nearshore areas were prolific benthic habitats and spawning areas.

Massive amounts of inland erosion materials are transported in the rivers and streams that flow through Texas and Louisiana and empty into the Gulf of Mexico. Prior to navigational intervention, their flows slowed as they reached the Gulf and the sediment in flow was deposited at the mouths of the rivers and streams, forming enormous shallow delta regions and shoals. A number of these original shallow mounds extended great distances out into the Gulf.

The original delta regions used to continually feed the Gulf shorelines with an abundant supply of new sand derived from the eroding inland sources. The backflow pressures created by the deltas were also critical to their related estuary and wetland ecosystems, including maintaining natural salinity levels.

On healthy sandy coasts, bottom sand is driven shoreward by natural processes generated by storms. This was once another major source of new beach sand for the Galveston shoreline sand budget. After storms, new shoals and sandbars formed and welded to the beaches. Galveston's beaches and adjacent shorelands continually expanded and elevated as shoreward winds moved dry sand landward. Its pristine coastal landmasses were thus formed by natural water and wind accretion processes. A lack of understanding of, and concern for, these natural processes has destroyed in a few decades much of what nature took centuries to create.

### **THE U.S. ARMY CORPS OF ENGINEERS**

Since its inception, the Corps of Engineers' domestic objectives have been to facilitate navigation and to design and develop federal water works and dams. Its actions have been based on numerical data derived from structural engineering sciences. Consequently, earth sciences, which study coastal landforms, their evolution and the processes at work on them, have been denied a role in our nation's coastal decision making and actions.

The thrust of the Corps' coastal research and activities has always been directed toward keeping harbors, channels, shipping routes and reservoirs deep, and free of obstructions such as natural deltas, shoals and sand bars. Federal navigation works, dams and other water works were constructed and maintained without reasonably adequate understanding of, and concern for their long term environmental, financial or

sociological impact. Protecting and preserving beaches has always been given lowest recreational priority by the Corps.

The dredging of navigational inlets has effectively broken our once interconnected shorelines into independent sectors and destroyed their shallow delta regions. Their destruction and the engineered narrowing of the channels to speed their flow (to make them self-dredging) forced the massive amounts of eroding inland materials suspended in rivers to bypass the immediate sand budget of our beaches and deposit on the near-offshore bottom.

The removal of the natural delta regions, located at short intervals along our shorelines, has resulted in the uncontrolled speed, size and destructive power of the nearshore currents. Without these natural "speed-bumps" controls, storms are able to generate high velocity parallel currents which scour sand out of the nearshore bottoms and deplete our beaches. These unnatural currents also stop new sand, which moves shoreward from the offshore bottom during storms, from attaching to the beach. Dredge maintenance programs prevent the deltas from reforming.

Hardening the shoreline by installing steel and wood bulkheads, seawalls, elevated groins, rock revetments and other defense structures, reflects the wave and current energy seaward and increases nearshore turbulence. This erodes the sand in front of them, resulting in deeper water, higher energy nearshore wave climates and the further magnification to the already destructive nearshore currents.

As nearshore current speeds increase, more sand is scoured out of the nearshore area and the currents are able to hold more sand in suspension. These beach sand laden unnatural currents traverse the shoreline at over four miles an hour during storms. They are turned seaward when they reach the first dredged inlet structure and then combine with the constricted river flow. The river sediment and beach sand are both forced to follow the channel's deep dredged track offshore.

Artificially deep dredged channels and their related pier type structures are the primary sand loss points of our shoreline sand budgets. During storms, a portion of the sand in parallel transport is deposited at the side of each dredged inlet structure as the currents are diverted seaward. A small portion continues on around the inlet and down the shore, but a major quantity of sand is redirected offshore and out of the beach budget.

Entrenched traditional coastal engineers and their related beach nourishment and rock contractors still only refer to a temporary blockage of sand by navigation structures. They claim that when the wind and current direction reverses, this material is redeposited back on the shorelines from which they were derived. These official coastal engineering assessments ignore the massive offshore diversion of beach and inland erosion materials caused by the deepened and narrowed channel itself.

Many public beaches are located adjacent to federal channels and piers. Over the years, thousands of swimmers have been dragged offshore and drowned by the rip currents that have developed next to them. The Ocean and Atmospheric Science Encyclopedia, McGraw-Hill, 1988, describes this offshore diversion: "In places where a relatively straight beach is terminated on the down current side by obstructions, a pronounced rip current extends seaward. During periods of large waves having a diagonal approach to the shore, these rip currents can be traced seaward for one mile or more."

Each artificial inlet is responsible for depleting great distances of the shoreline, inter-related through the sharing of sand. On sedimentary shorelines which cover wide geographic distances, instead of the sand transport system becoming more laden with eroding sand as it flows downshore during storms, sand is extracted from the flow at each inlet interrupting the natural flow. Thus on shorelines with closely spaced inlets, downcurrent transport systems often contain less sand than their upcurrent counterparts.

#### NAVIGATIONAL SERVITUDE VS THE COASTAL RIPARIAN

Environmentally concerned citizens, fishermen, shoreline property owners and resort communities have protested the destruction caused by the Corps' water projects since their beginning. But, they were told by the U.S. Army Corps of Engineers that they were empowered to cut off coastal shoreline riparian property rights, without compensation, for the sake of navigation. The Corps has always operated under the assumption that river banks and open coastal beaches were both subject to navigational servitude under the commerce clause of the U.S. Constitution. [Art I, § 8(3)]

Over the years, rivers were replaced as the nation's "primary highways of commerce" and a growing coastal tourism industry became vital to nation's economy as well as its quality of life. As coastal beaches increased in importance, Congress directed the Corps to begin shore protection programs. The Corps response was to defend against the force's of nature by constructing, recommending and permitting the use of coastal armoring.

Each engineered alteration to Galveston's shoreline increased the amount of sand being siphoned out of the nearshore areas. Its shoreline sand budgets have suffered an unprecedented period of continuing net loss. The shallow sandy near-offshore areas had slowly become deeper and deeper. The nearshore beach profiles steepened as they became vulnerable to increased wave action. When Galveston's nearshore areas became deep enough to allow large waves to encroach the water's edge, its wide elevated beaches and their related wildlife habitats were directly attacked.

By the mid-nineteen hundreds, coastal homes and other inland structures along most of our nations sandy coastlines were being assaulted because of the unnatural deep water wave climates that had developed. Decades of protests and litigation lead to a 1967 U.S. Court decision that disagreed with the Corps' assumption that open coastal shorelines were subject to navigational servitude. *United States v Rands* held that only those waters which "are used, or are susceptible of being used, in their ordinary condition, as highways for commerce" are subject to the servitude. Shallow open coastal nearshore areas and shorelands are not.

Subsequently, elected representatives from coastal states co-sponsored and helped pass Section 111 of the River and Harbor Act of 1968. Section 111 mandated that the Corps of Engineers "study, investigate, prevent and mitigate shore damages attributable to Federal navigation works...to be paid by the United States." But, Congress failed to provide Section 111 with the tools necessary for an independent, unbiased and scientifically valid assessment of the broad scale impact of federal navigation works on our shorelands.

The Corps' resulting Mitigation of Shore Damage Reports grossly understated the true magnitude of attributable damages. These published conclusions that "our coastal losses are primarily attributable to nature, not their Federal works," circumvented the Act's Congressional intent and reduced the Corps' culpability. In addition, the Corps' coastal regulatory policies and permit procedures discourage and obstruct private sector involvement in the development of ecologically based technologies aimed at restoring our shorelines and environment. Consequently, the attributable damage has significantly increased since Section 111 passed.

Congress continues to authorize and allocate billions of dollars to the Corps' coastal war against nature. Mechanical dredging, anti-nature type armoring constructions, pumped beach nourishment programs and "hazard zone" mapping studies continue despite the rising opposition to these temporary, destructive and costly defensive approaches.

Perpetual sand replenishment programs have become the treatment most recommended by the Corps and its recognized (and profitable) coastal consulting firms. The Corps' related coastal experts and contractors continue to embrace them - long-term profits combine with the absence of contractor liability to provide an incentive for bureaucratic conflicts of interest - at the expense of coastal property owners, tax payers, investors, and our environment.

The entrenchment of beach nourishment as the only recourse to coastal erosion is having the effects of perpetuating an unnecessary dependency on continual renourishments; avoiding the need to alter traditional Corp-project technologies; and

has impeded permanent, environmentally sensitive technologies that have emerged in the private sector from fairly competing with the elite Corp contractors.

#### ACCRETION BASED SHORELINE EXPANSION TECHNOLOGY

A growing number of scientists, environmentalists, legislators and educators have begun to publicly disagree with the Corps' published conclusions that our sandy shoreline losses are of natural origin. They have amassed substantial documentation that the ongoing coastal shoreline destruction is not an incurable natural phenomenon.

Costly and destructive armoring, beach renourishments and mandatory retreat via set-back laws (hazard zoning) are diverting the blame and burden to the innocent victims. Those most concerned about our coastal environments are finally demanding that we focus on the actual cause instead of blindly treating the symptoms. This group is being lead by an unlettered coastal pioneer named Dick Holmberg.

Holmberg discovered the existence of unnatural and destructive parallel currents over thirty years ago by placing himself in special protective gear for first hand study and observation of storm processes in nearshore areas. He also made discoveries about offshore sand supplies and the shoreward migration of this important sand source for beaches. A key to his discoveries was the fact that unnatural nearshore tracking currents act as barriers to incoming sediment.

The history of accretion based shoreline restoration and expansion technology parallels Dick Holmberg's 33 year coastal shoreline career. It includes over 1,500 traditional and high tech marine construction projects. The successful Holmberg Method of beach restoration is based to a large degree on his hard-won and unique understanding of complex nearshore dynamics.

The new concept of working with nature instead of fighting it met with strong opposition from the Corps and its traditional coastal engineers and contractors. Holmberg was forced to develop this alternative coastal restoration method independently. His patented Undercurrent Stabilizer Systems™ neutralize aberrant patterns caused by modern engineered shorelines - without disturbing navigational interests.

Although the Corps has issued his permits, monitored his unique underwater structures and received numerous documentation packages and client affidavits from Holmberg for years, they still appear to be in the earliest stages of recognizing his discoveries. A June, 1990 New York Times article covered the Corps' latest research efforts at Duck, N.C.. It reported their "discovery" of phenomena that Holmberg has been aware of and working with for many years - the existence of powerful parallel nearshore currents. The Corps researchers stated, "we were surprised by the very

strong currents...how they affect the beach we're not sure, but a big current carries a lot of sand around."

Since 1983, Holmberg has designed and constructed more than 150 "artificial delta regions" on private beaches along the Great Lakes and ocean shorelines with documented success. In 1989, Michigan became the first coastal state to fund major coastal expansion projects which utilize Holmberg's much larger Coastal Restabilization Anchor Systems™.

Strategically placed artificial delta regions duplicate the regulatory functions once provided by original natural delta regions. Nearshore currents and waves are subjected to a series of uplifts as they pass through a grouping of these "underwater speed-bumps." Their velocities are reduced without redirecting them offshore, similar to an airfoil. During storms, the sand suspended in the currents is induced to accrete and be retained in the artificial delta regions. This sand in nearshore transport is prevented from being diverted offshore and out of the beach budgets.

The elimination of the high speed barrier currents also allows natural processes to once again move into the beach budget from the offshore bottom. These artificial delta regions will permanently act as storage and feeder areas for their inter-dependent coastal cells. The beaches return to a net expansion mode and remain self-protective indefinitely.

*Unlike groins, Holmberg's ultra-low profile underwater structures do not steal sand from adjacent properties. To the contrary, they induce new offshore sand to be once again added to the whole sector's sand budget. They act as storage and feeder areas that benefit the rest of their inter-related shoreline.*

The structures are usually completely buried under accreting sand within the first two years. In catastrophic coastal situations where timing is absolutely critical, a Coastal Restabilization program can be augmented with a one time pumped sand nourishment (full or partial).

An Undercurrent Stabilizer System is a one-time expense, requires no maintenance, doesn't interfere with navigational deep water interests or tourism, and costs less than temporary armament or sand replenishment. Major lending institutions have begun to remove coastal properties from the high-risk category once they have been restored through this technique and new, full-term mortgages have been extended to previously ineligible coastal properties.

It is only a matter of time until state and federal legislators begin to facilitate accretion based shoreline restoration and expansion programs on a broad scale.

**TWO PHOTOS TAKEN OCTOBER 1983 & OCTOBER 1988  
GULF OF MEXICO SHORELINE, MANASOTA KEY  
ENGLEWOOD, SARASOTA COUNTY, FLORIDA  
Project Site: 7160 to 7040 Manasota Key Rd.**

**UNDERCURRENT STABILIZER SYSTEM™  
INSTALLED 1982**

**Unstabilized erosion trend for Englewood Gulf of Mexico coastal area:  
2 to 3 foot loss of beach width and dune per year**

**Undercurrent Stabilizer System site 1983 to 1988  
net change in beach:**

**70 foot of net gain of beach width in five years.**

**Increase in beach elevation = 5 feet plus in five years.**

**5 year nearshore shallowing 500 feet plus from water's edge.**





Englewood, Florida  
October, 1983



October, 1988

**AERIAL PHOTO TAKEN JULY 27, 1990  
GULF OF MEXICO SHORELINE, MANASOTA KEY  
ENGLEWOOD, SARASOTA COUNTY, FLORIDA  
Project Site: 7160 to 7040 Manasota Key Rd.**

**UNDERCURRENT STABILIZER SYSTEM™  
INSTALLED 1982**

**SURVEY DONE BY  
Lemonde of Florida, Inc.  
Daniel E. Lemonde PLS #2909  
August 16, 1990**

**Unstabilized erosion trend for Englewood Gulf of Mexico coastal area:  
2 to 3 foot loss of beach width and dune per year**

**Undercurrent Stabilizer System site 1982 to 1990  
net change in beach:**

**Average of 10 foot of net gain of beach width per year.  
Increase in beach elevation = 6 feet plus over eight years.  
Nearshore shallowing /60 feet plus from water's edge.**



B

UNLESS SHOWN OTHERWISE, THE APPROXIMATE MEAN HIGH WATER LINE AS SHOWN ON THIS PLAN IS NOT A FINAL PROPERTY BOUNDARY, WAS NOT LOCATED IN ACCORDANCE WITH PROVISIONS SPECIFIED IN THE "COASTAL ZONING ACT OF 1964", CHAPTER 127, PART 22 OF THE FLORIDA STATUTES, AND THE RULES OF THE DEPARTMENT OF NATURAL RESOURCES, CHAPTER 10-1 OF THE "LAND USE ADMINISTRATIVE CODE", AND IS NOT TO BE USED AS, OR CONSIDERED TO BE, OR CONSIDERED AS A FINAL PROPERTY BOUNDARY LINE. BEING A SURVEY OF THE PROPERTY OF THE COUNTY OF LEON, THE APPROXIMATE MEAN HIGH WATER LINE HAS BEEN USED AND IS BEING INCORPORATED TO THE PROPERTY FOR WHICH THIS PLAN HAS BEEN PREPARED.

MANASOTA KEY ROAD

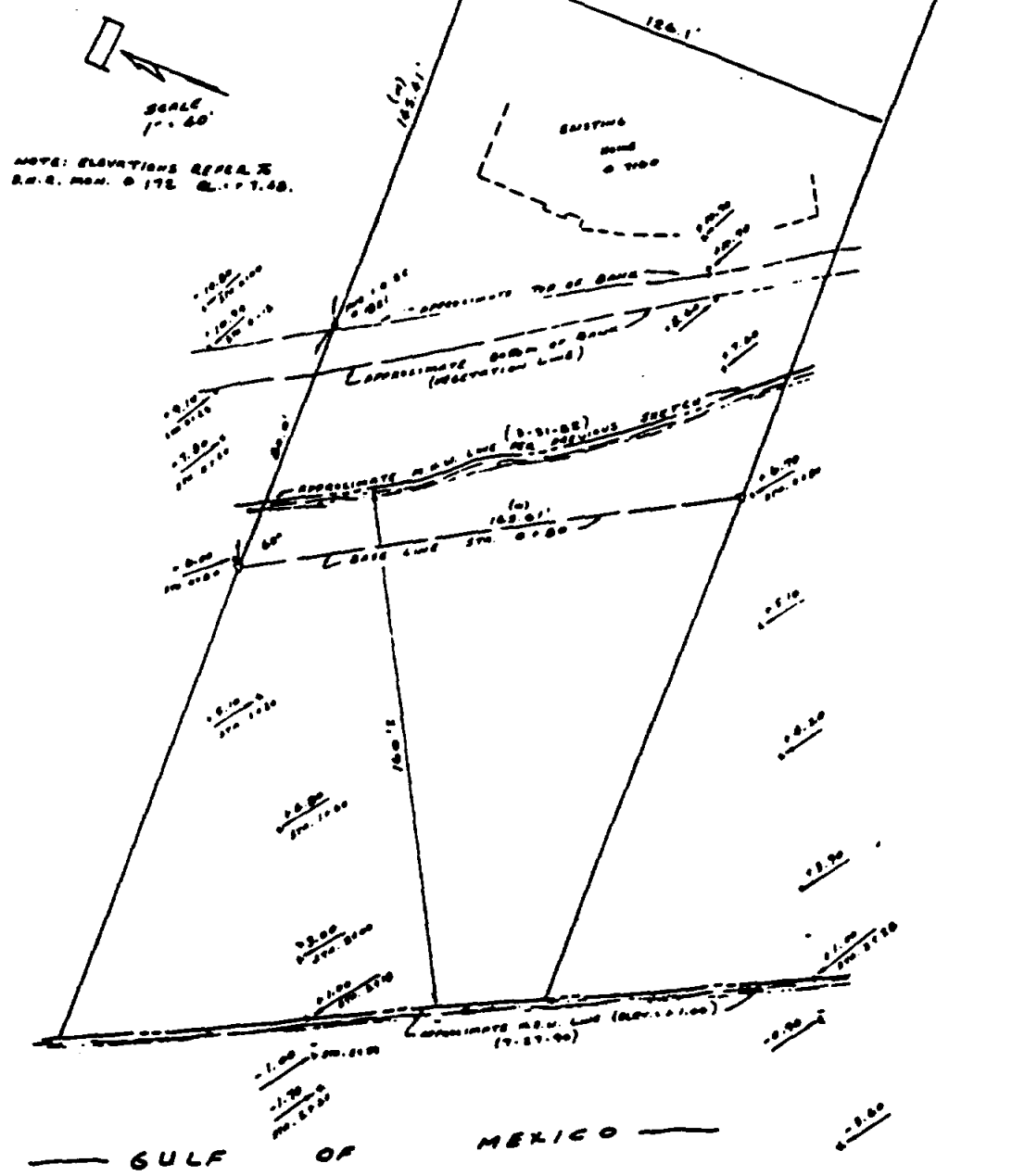

NOTE: ELEVATIONS REFER TO  
R.M.S. MEAN 0 172 C. 1 P. 48.

← 160' ACCRETION IN 8 YRS →  
L.M.A.

CERTIFIED AS TO ELEVATIONS ONLY  
"NOT A BOUNDARY SURVEY"

*D.E.L.*

8-16-90

DANIEL E. LEMONDE PLS # 2909

"SPECIAL PURPOSE SURVEY": SHOWING EXISTING ELEVATIONS AND BEACH LOCATION ON THAT PART OF THE SOUTH 126.1 FEET OF THE NORTH 426.1 FEET OF SECTION 27, TOWNSHIP 40 SOUTH, RANGE 19 EAST ON MANASOTA KEY LYING EAST OF THE COUNTY ROAD. SARASOTA COUNTY, FLORIDA.

FOR: COASTAL EXPANSION SYSTEMS  
DATE: 7-27-90 FILE NO: 90-07-21



**TWO PHOTOS TAKEN JULY 1987 & JULY 1988  
LAKE MICHIGAN NORTHEASTERN SHORELINE  
FRANKFORT, BENZIE COUNTY, MICHIGAN**

**UNDERCURRENT STABILIZER SYSTEM™**

**INSTALLED JULY 1987**

Project site located approximately 2 miles south of the Federal Navigation Channel at Frankfort Harbor and approximately 9 miles north of the Federal Navigation Channel at Arcadia Harbor.

**SPECIAL NOTE:** Re-vegetation of the bluff face and induced foredune growth were implemented on the project site by Mr. Holmberg shortly after this shoreland had widened and elevated sufficiently to protect it from future wave attack. The 200 foot dune face is protected against wind erosion, rain and ground water seepage. Critical habitats for endangered species of wildlife have also been re-introduced to the project site.

Unstabilized erosion trend for the south of Frankfort coastal area:  
**3 to 5 foot average loss of beach width and bluff per year**

Undercurrent Stabilizer System site July 1987 to July 1988  
net change in beach:

**100 foot of net gain of beach width first year.**

**Increase in beach elevation = 4 feet plus first year.**

**Nearshore shallowing 300 feet plus from water's edge.**



Frankfort, Michigan  
July, 1987

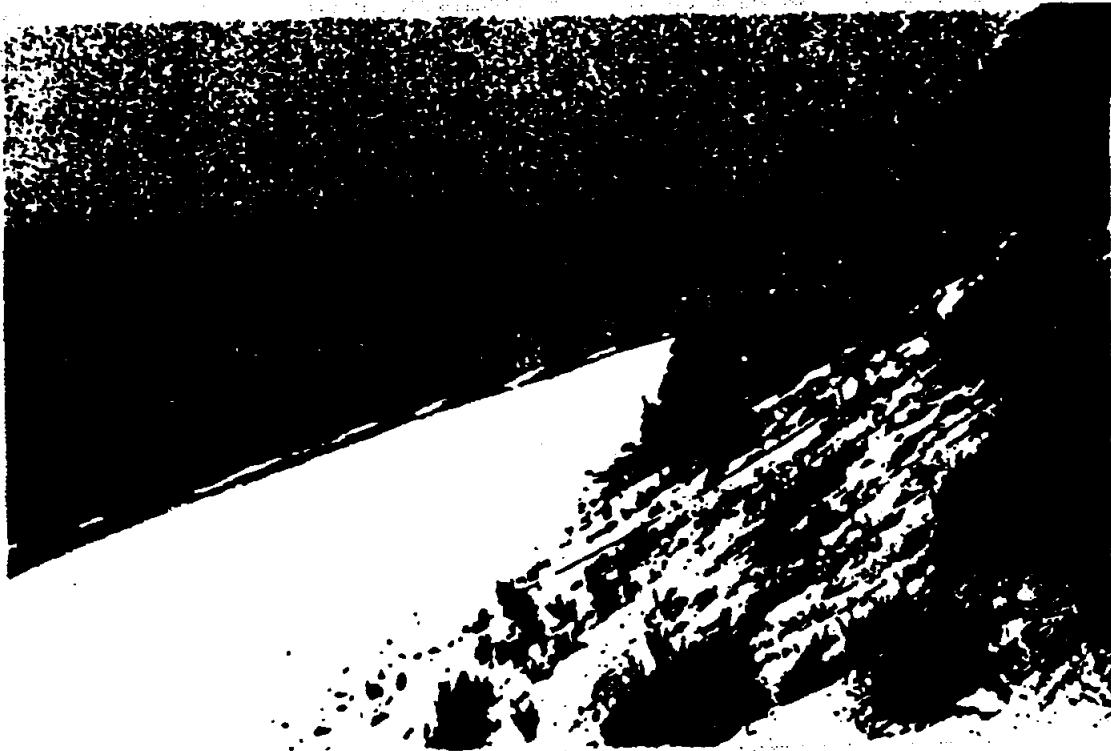

July, 1988

3/25/88  
3/25/88

## UNDERCURRENT STABILIZERS™ vs GROINS

### **ELEVATED GROINS**

The basic design and methods of utilization of elevated groin type structures have changed very little since their introduction to our coastal shorelines over a century ago. The traditional groin structure is constructed of piled rocks, piled riprap, wood, steel, concrete and other materials. They are constructed to create mass sufficient enough to withstand the forces inherent to the shoreline environment. Despite the differences in their final appearance, all groins are intended to forcefully trap a certain amount of sediment while allowing any access to continue around them in a longshore direction. Recent findings indicate this is not true. Although they may give temporary protection to the property directly behind them, they have been proven to adversely impact the adjacent shorelines.

Groins are based upon an adversarial relationship with natural shoreline processes. They do not ecologically or scientifically address the dynamic principles of aquatic motion or coastal geomorphology. Groins and other anti-nature type armoring structures reflect wave and current energy seaward and increase nearshore turbulence. This erodes the sand in front of them, resulting in deeper water, higher energy nearshore wave climates and the further magnification of unnaturally destructive parallel currents. Groins divert a significant portion of the suspended nearshore sediment offshore and out of the local beach sand budget.

The understanding of coastal sediment transport processes and unnatural shoreline losses has been dramatically increased by the efforts of an unlettered coastal pioneer named Dick Holmberg. Although his Undercurrent Stabilizer Systems™ (generically referred to as artificial deltas) are constructed at right angles to the shore, that is where the similarity to their predecessor groins ends. By analogy; although the Wright Brothers were able to achieve very limited flight without the total comprehension of aerodynamic principles. But stable flight was successfully achieved only after those principles were fully understood and incorporated into aircraft designs.

In direct contrast to groins, Stabilizer Systems are dynamically designed to reestablish control over aberrant nearshore zone sediment flow patterns. Holmberg developed his artificial delta regions to replace the natural deltas destroyed by environmentally insensitive coastal engineering practices of the past. They help nature neutralize the wide-scale offshore diversion of beach sand by Federally dredged navigation channels and armoring. This is accomplished by utilizing the energy of the nearshore currents and waves instead of fighting them.

The vast majority of sand that accretes in an artificial delta region would have been diverted offshore by the navigation channels and structures that the currents encounter. It would have been lost to the whole coastal shoreline's sand budget indefinitely. Instead, the newly formed artificial delta region acts as a storage/feeder region, accumulating new sand and distributing it to the intra-related beaches within its coastal cell. Sand is thus retained within the sand budget, to be shared by all the inter-dependent coastal beaches along great distances of shoreline.

## **STAND-ALONE UNDERCURRENT STABILIZATION™**

Undercurrent Stabilizer Systems are usually designed and constructed on a stand-alone (without mechanical beach nourishment) basis to re-establish a pro-gradation profile to a shoreline that has suffered long term net sand budget deficits. A series of Stabilizers is installed near-perpendicular to the shoreline at regular intervals along the beach and on the nearshore bottom. They extend from the landward edge of the project area to a distance offshore, submerged, and following the existing bottom profile. Patented anchoring systems, foundations and flexible hinged construction techniques control the structural movement during the critical early stages of the artificial delta region formation.

Each ultra-low profile structure creates an uplift similar to an airfoil. The sand laden nearshore currents and waves are elevated without creating a directional change in seaward motion. A grouping of Stabilizers creates a series of repeated uplifts which reduces the current and wave velocities, forcing the sand suspended in them to drop out of suspension and attach to the shoreline. The neutralization of these unnatural barrier currents also allows new sand to once again be moved in from the offshore bottom by natural processes during storms.

Sand accretion is induced without impacting adjacent stretches of beach. To the contrary, artificial deltas also induce upcurrent and downcurrent accretion. Once the System reaches maturity, its intra-related area sand budget maintains a controlled equilibrium indefinitely.

Several stand-alone pilot Undercurrent Stabilizer Anchor Systems are generally installed along a project shoreline area prior to the completion of the area wide system. Anchor Systems are utilized to analyze the accretion characteristics of the inter-related shoreline project area. In most coastal regions, induced accretion rates are sufficient enough to provide a steady increase in recreational and protective beach area. When there is enough time available (two to four years) the stand-alone alternative is by far the most cost effective and environmentally compatible.

## **STABILIZATION PLUS A ONE TIME BEACH NOURISHMENT**

In situations where time is absolutely critical, Undercurrent Stabilizers can be utilized in conjunction with a one time (full or partial) mechanical renourishment. Also, in rare cases where the induced accretion vs offshore diversionary loss ratio approaches equilibrium (1/1), a one time partial nourishment will accomplish an immediate and permanent expansion of critical beach areas.

The Stabilizers extend offshore beyond the actual renourishment. An artificial delta region will form beyond the renourishment area. Induced accretion will elevate the offshore profile seaward of the nourishment, future losses will be eliminated and additional beach area will be gained.

Stabilization plus one nourishment may be the only politically and economically viable option left to a community under certain existing government policies. In a situation where a community has no other recourse, it will help make the program more environmentally sensitive and eliminate the need for future renourishments. The cost vs benefit ratio makes it a highly cost-effective alternative to creating an unnecessary dependency on continual renourishments.



BOARD OF TRUSTEES

TOM MANISON-CHAIRMAN  
CHARLES DELGADO  
JOHN SCHMIDT  
VELMA ACREE  
B. T. SEARS  
BOB WICKLANDER  
COMMISSIONER BILLY J. PEGUES



EXECUTIVE DIRECTOR  
PAT HALLISEY

## GALVESTON BEACH AND SHORE PRESERVATION COMMITTEE CO CHAIRMEN PAT HALLISEY (COUNTY) & RUSS EITEL (CITY GALV)

Galveston Beach and Shore Preservation Committee  
613 19th St.  
Galveston, TX. 77550  
1-409-766-2411 or 1-713-337-3584

Dr. John B. Anderson  
Rice Univ. Dept Geology  
P. O. Box 1892  
Houston, TX. 77251

Dr. John Herbich  
TX A&M Ocean Engineering  
TX A&M College  
College Station, TX 77843  
3136

Dr. Y. H. Wang  
TX A&M  
P. O. Box 1981-374  
Galveston, TX 77554

Dr. George H. Ward  
UT Research Scientist  
10100 Burnet Rd.  
Austin, TX 78758 - 4497

Dr. Robert Morton  
UT Research Scientist  
Box X  
Austin, TX 78713 - 7508

Dr. Herman Rudenberg  
Sierra Club  
3327 Ave. Q 1/2  
Galveston, TX 77550

Dr. Thomas Straw  
Western Michigan Univ.  
Geology Department  
Kalamazo, Michigan 49008  
5150

Dr. Frank Judd  
Pan American Univ. SPI  
Coastal Studies Lab.  
South Padre Is. TX 78597

Ralph Clark  
Chief Coast Bureau  
3900 Commonwealth  
Tallahassee, FL 32303

Secretary of Army  
via The Honorable Jack Brooks  
House of Representatives  
2449 R.H.O.B.  
Washington, D. C. 20515

Re: Galveston County shoreline restoration and expansion pilot projects.  
(1) 2 1/2 miles north of Rollover Pass (adjacent Highway 87), (2) West end of Seawall Galveston Island (adjacent to Delanaro Park), and (3) 13 mile road on West Beach (adjacent to Texas Parks and Wildlife Park, and planned pocket park).

Dear Beach Authorities:

Our Galveston Committee wants to adopt methods of combating erosion. Texas has not tried any of the many world known application of shore erosion abatement. Beach nourishment, sand by passing, littoral dumping, jetties, breakwaters, hardening of the shoreline, and many other applications all have their problems. This is why we are asking you to comment on what appears to represent a possible method least objectionable with many success projects in place.

Enclose three proposed project sites in Galveston County for pilot projects of undercurrent stabilization anchor systems. Our Committee can only evaluate the successful use of this type projects. It costs less and appears to cause a lot of accretion. Our evaluation needs your help on technical evaluation of this restabilization technology that works with forces of nature to re-introduce the natural processes which will once again move new sand into Galveston's beach budget. Enclosed 21 pages demonstrate applications and exhibits two projects that are now in place.

Your endorsement is not needed, but we do need your evaluation of such a application as follows;

1. page 2. "The sand that accretes to form an artificial delta region would have otherwise been diverted offshore by the navigation channels and structures that the sand laden currents encounter. It would have been lost to the whole coastal shoreline's sand budget indefinitely. Instead, the newly formed artificial delta region acts as a storage/feeder region, accumulating new sand and distributing it to the intra-related beaches within its coastal cell. Sand is thus added to and retained within the sand budget, to be shared by all the inter-dependent coastal beaches along great distances of shoreline."

Your evaluation -- New sand accretion is taken from a source that has previously been diverted offshore. Can you determine if this new sand is presently lost offshore, or does this new sand represent sand destined for another beach down stream.

2. page 6 -- "Unlike groins, Holmberg's ultra-low profile underwater structures do not steal sand from adjacent properties. To the contrary, they induce new offshore sand to be once again added to the whole sector's sand budget. They act as storage and feeder areas that benefit the rest of their inter-related shoreline."

Your evaluation -- Generally a breakwater forms a tombolo out of new sand. Some claim this new sand is erosion from another adjacent beach. Can you comment on this projects claim that new sand accretion comes from littoral flow that would be lost to any beach.

3. page 14,15,a29,b30,&c31 -- This enclosure demonstrate a location in Florida that has had 160 foot accretion since 1982. Would you like to see accretion demonstrated in Texas Coastal waters similar to this Florida project, or would you consider it a waste of time.

4. Would you suggest what type project you would like to see applied to abate erosion trends other than this proposed test pilot project.

Your comments would help our Committee justify selecting methods of combating erosion. If you have time we would greatly appreciate your input on this proposed pilot project.

Respectfully,

  
John M. Arrington

Address all correspondence to  
John M. Arrington  
7025 Kopman  
Houston, TX. 77061  
1-713-649-4795 or 1-409-737-2684

COMMENTS ON  
HOLMBERG TECHNOLOGIES  
Undercurrent Stabilization Anchor Systems

by

Dr. Y.H. Wang, P.E.

General Comments:

The Holmberg Technologies - Undercurrent Stabilization Anchor Systems, as it is presented, appears to be a sales and commercial document contained very little quantitative technical information. From the technical point of view, this company needs to provide more quantitative technical information before being granted the 2.5 million dollar contract.

There are good points as well as questionable points in Mr. Dick Holmberg's proposal. Here I only raise some of the questionable points in the following.

The Executive Summary:

Mr. Dick Holmberg indicated what he wanted to do for stabilizing beaches on Galveston Island and Bolivar Peninsula. However, the subsequent text of his proposal did not provide enough evidences that he really can deliver the results as promised.

Project Cost:

A breakdown on the project costs is desirable for projects of experimental/pilot in nature.

Work With Nature:

Mr. Holmberg claims to work with the forces of nature to re-introduce the natural processes ... However the site locations on Galveston Island and Bolivar Peninsula are unnatural. The installation of the "Anchor System" looks like an artificial low profile submarine ridge in an otherwise smooth continuous shoreline. Submarine ridge often focuses wave energy rather than disperse it.

### Costal Re-stabilization Anchor System:

No dimensions of the "Anchor System" to be installed on Galveston Island and Bolivar Peninsula are given. Judging from the two figures on pages 4 and 5, the length of the anchor system is very short compared to the miles of beach to be expanded by the proposed system. This disproportionment is unlikely to be realized.

### Three Photographs Showing The "System" at work:

Three photographs showing before and after the deployment of the "Anchor System" are not convincing for the following reasons.

- (a). No up-drift and down-drift effects are shown. If the "Anchor System" indeed can accrete beach miles away from the installation, Mr. Holmberg may have already shown them in those pictures.
- (b). The local accretion in the pictures may indicate the natural variability of the beach rather than the effect due to the installation of the "System". It is known that beach in that region may accrete 3 to 5 inches of sand in one tidal cycle during an accreting phase.

**APPENDIX B**

**STABEACH SYSTEM**

**AND**

**COMMENTS BY WANG**

**SAILFISH POINT (STUART) FLORIDA: FIRST DEMONSTRATION  
OF THE DEWATERING APPROACH TO BEACH STABILIZATION**

James M. Parks, Ph.D.  
Regatta Pointe,  
1001A Riverside Dr.,  
Coastal Stabilization, Inc.  
Palmetto, Florida 34221

Emeritus Professor  
Dept. of Geological Sciences  
Lehigh University  
Bethlehem, Pennsylvania  
(Director, Center for Marine  
& Environmental Studies)

**Abstract:**

Wave uprush brings sand onto the beach -- and the returning backwash takes sand off the beach. Dewatering the beachface retards that second stage of taking sand off the beach, thereby leaving additional sand on the beach.

By lowering the water table near the high tide line, the system creates an unsaturated zone under the beach face which allows downward percolation of wave run-up; and interrupts the natural ground water flow to the beach thus reducing the erodibility of the beachface. This reduces the return swash on the beach face, limiting the erosion process while leaving more sand on the beach. Comprehensive monitoring of similar systems in Denmark shows that downstream beaches do not suffer effects of sufficient magnitude to distinguish from normal fluctuations.

The first beachface dewatering system in the United States is now being installed on the Florida East Coast at Sailfish Point, near Stuart, Florida. The system is expected to be in operation in September, 1988. This new product has been named STABEACH System.

**INTRODUCTION**

Many different approaches have been tried in attempts to solve or alleviate the problems of beach erosion. "Hard" structures such as seawalls and revetments have been used to stop erosion, but usually at the cost of loss of some beach. Groins (to hold sand on beaches) and jetties (to keep sand out of inlet channels) are partially successful in the short term, but have serious long term detrimental effects on downstream beaches. Breakwaters of various kinds have also had a checkered history of successes and failures. Hard structures are generally quite expensive and have more or less adverse environmental effects. Less expensive "soft" structures such as plastic seagrass (Rogers, 1987) and Longard Tubes have not been very effective.

Until now, the only effective (but expensive) answer to the erosion of beaches has been beach nourishment -- the dredging of sand from offshore locations and the placing of that sand on or near the eroded beach. A major problem with beach nourishment is that it sometimes doesn't last -- in some cases a significant portion of the "new" sand is lost in the next major storm or within a year or so (Bokuniewicz and Schubel, 1987; Domurat, 1987; Herron, 1987; Pearson and Riggs, 1981; State of Florida, 1986; CERC, 1984; and Wiegel, 1987). Relatively recently, sand bypassing (the periodic dredging of sand from sediment traps usually located inside of jettied inlets -- or from fixed or movable permanent

installations in a few cases -- and the placing of that sand on or near downstream "feeder" beaches) has been proposed and put into practice in a few places with limited and partial success (Bruun, 1974; Edge et al, 1987; Domurat, 1987; Herron, 1987; USACE, 1984; and Wiegel, 1987).

## HOW THE STABEACH SYSTEM WORKS

A totally new approach to the alleviation of beach erosion problems has recently been developed -- the STABEACH System. It involves a permanent installation of pipes and pumps, but it is not a visible eyesore or physical obstruction as nearly everything is buried, out of sight and sound and below normal storm erosion.

The beach is temporarily disrupted during installation of the STABEACH System (see Figures 1, 2, and 3). When the installation has been completed, the beach will be returned to its pre-work condition (Fig. 4). Operation of the system will then stabilize the beach, and over a period of months may widen it appreciably.

The scientific principles behind the effect produced by beach-face dewatering have long been known (Bagnold, 1940; Grant, 1948; Emery and Foster, 1948; Isaacs and Bascom, 1949; Duncan, 1964; Harrison et al, 1971; Harrison, 1972; Holland, 1972; Machemehl et al, 1975; Waddell, 1976), but were not reduced to practice.

Extensive long term full-scale controlled demonstrations in Denmark have shown that beachface dewatering systems have a positive effect on the treated beach and no noticeable side effects on downstream beaches (Hansen, 1986). A similar beach dewatering project in Namibia (Southwest Africa) is reported (Wiegel, personal communication) to have achieved spectacular success over a period of many years in sustaining a beach "wall" moved 900 feet seaward to allow placer diamond mining in rock crevices beneath the former beach. This has been achieved on a coastline with a reported net littoral drift in excess of one million cubic meters per year.

Wave-action brings sand to the active beachface. At the surf line where incoming waves first "touch" bottom and "break", the resulting turbulence and agitation stirs up and throws some sand into suspension in the water, and a small portion of this suspended sand is carried onto the beachface by the wave run-up (Figure 5). Under normal conditions, the backwash running down the slope of the beachface (Figure 6) carries as much sand off the beach as was brought on during the upwash. Beaches are normally in a state of dynamic equilibrium -- erosion and accretion are always occurring. The net effect -- accretion minus erosion -- under a specific set of conditions (wave period, wave height, etc.) may be either negative (= retreat) or positive (= advance) on the position of the shoreline. This balance may be tipped toward accretion -- beach advance -- by low frequency gentle waves such as may occur during the summertime. Conversely, the balance may be tipped toward erosion by larger higher frequency steeper waves from storms, usually associated with wintertime, that tend to carry more sand off the beach than is brought on to it by the waves.

With gentle low frequency waves, there is sufficient time between each wave run-up for a substantial portion of the water in

the upper beachface to drain down through the beachface sand to the water table, leaving a zone of unsaturated sand that can absorb a small portion of the next wave run-up -- with the result that less water runs off the beachface than ran up the beach face, and thus less sand is carried away than was brought to the beachface. Each wave run-up and backwash leaves a few "extra" grains of sand on the beach -- with waves at 10 second intervals, this happens 8,640 times in a 24 hour day, so a small quantity of sand added with each wave accumulates to a significant quantity in a few days or weeks.

With steeper, high frequency waves, there is not enough time between waves for water to drain out of the upper beachface -- this zone remains saturated, and all of the run-up from one wave runs back off. Because the upper beachface sand is saturated with seawater, sand grains are more readily incorporated into the run-off bed load and thus more sand is carried off the beachface, resulting in net erosion. With waves at 7 second intervals, this happens 12,347 times in a 24 hour day, so beach erosion can be rapid. The water table may actually become slightly elevated, causing a positive (seaward) seepage of water through the beachface, further enhancing erosion by the backwash.

Waves bring sand onto the beach -- and the returning backwash takes sand off the beach. The STABEACH System retards that second stage of taking sand off the beach, thereby promoting accretion and beach advance.

The STABEACH System works by lowering the water table near the high tide line. This is accomplished by pumping water out of a buried horizontal filter pipe which creates an unsaturated zone under the beach face (Figure 7). This allows downward percolation of wave run-up similar to that occurring during summertime low frequency waves. Thus the return swash on the beach face is reduced, limiting the erosion process and leaving (putting) more sand on the beach. The linear zone of lowered water table further acts to interrupt or cut off the local ground water flow towards the sea, thus reducing "positive seepage forces" on the beachface, and thus decreasing the erosive effects of wave runoff.

Comprehensive monitoring of the Danish installations since 1985 shows that this "additional" sand apparently comes mostly from modifying the offshore bottom profile (Figure 8), and that downstream beaches do not suffer any significant or measurable retreat (Hansen, 1986). Normal seasonal modifications of the offshore bottom profile produce semi-annual oscillations in the position of the shoreline: slight advances (accretion) during the summer, and retreat (erosion) during the winter (Figure 9). This process alone cannot account for the volume of sand involved in the documented advance of beaches by the action of beachface dewatering in Denmark. However, strict application of this winter/summer process is only a two-dimensional view of what must be a three-dimensional process -- the third dimension is provided by longshore drift which for a part of the year replenishes the sand taken from the offshore bottom profile.

Downstream beaches are not starved or eroded because the STABEACH System does not block or materially disturb the nearshore longshore drift of sand as does a groin or jetty. Of perhaps even



more significance, a groin or jetty will divert or force the remaining portion of the littoral drift out to an area further offshore for some appreciable distance downstream, so that the longshore drift cannot naturally nourish these downstream beaches. Without a continual supply of additional sand from the littoral drift to balance the natural transport of sand by waves breaking on a beach, the result is net erosion and retreat of the beach. The STABEACH System does not have this side effect. The STABEACH System extracts only a small percentage from the total volume of sand moved by the littoral drift past that point on a beach, thus leaving the greater bulk of that sand in movement to proceed further down the coast, thus preventing downstream erosion.

The sandy bulge along the coast produced by the STABEACH System (Figure 11) will shed a significant steady volume of sand, feeding into the downstream longshore drift, when the bulge has accreted to the limits of effectiveness of the configuration of the dewatered zone on the original beachface, or when the system is "turned off". This additional drift may take the form of a smeared out continuous "accretion wave", as described by Inman (1987).

Sand deposited on a beach by the STABEACH System enhancement of natural processes is winnowed and sorted by natural forces to be size-compatible with that specific beach -- in contrast with artificial beach nourishment using sand dredged from offshore "borrow" areas. This sand is usually poorly sorted and either too coarse or too fine, leading to a rapid loss of substantial amounts (30 to 50 percent in the first few months is not uncommon) of that sand from the nourished beach. Some beach retreat is expected after renourishment because of profile adjustment, especially when the new sand is not properly distributed.

Another potential benefit from the STABEACH System is accelerated compaction of newly placed beach nourishment sediments, to make them more resistant to erosion. It is a common practice in construction to compact sediments by inducing downward percolation with well-point dewatering. There could be significant economic benefits to widening an eroded beach to only half of the usual width by conventional beach nourishment, at a significantly reduced cost, and then stabilizing that beach with a STABEACH System emplaced before the added width is lost to early erosion.

For a normal installation at a recreational beach, after the beach has advanced seaward and built upward far enough for recreational and/or storm protection purposes, pumping could be reduced to a few hours per day or a few days per month to maintain the balance of beach advance/retreat. After a major storm erosion event, the pumps could be run continuously for several days or weeks to rebuild the beaches quickly -- to "heal" the storm damage.

The existence of a significant tidal range -- two to four feet or more -- is probably essential for efficient operation of the STABEACH System. Without tides (for example, sand beaches on the shores of the Great Lakes), sand would be accreted at one location only on the beachface; whereas with tides, sand would be accreted from the low tide strandline location across a significant distance of the beachface up to the high-tide location of the strandline. Furthermore, the tidal shifts would act as a "pump" to take sand

accreted at the lower position and move it up the beachface with the rising tide to the higher position. During the subsequent lower tide positions of the strandline, the upper accretions would tend to dry out, and the sand would then be carried by on-shore winds to other parts of the beach (for instance, inland of the berm) to form sand dunes.

#### CONTROLLED DEMONSTRATION OF BEACHFACE DEWATERING IN DENMARK

In 1985 a full-scale controlled demonstration facility was initiated along the extremely wave-battered North Sea coast at Torsminde (Jutland), Denmark, where the annual fluctuation of the coastline normally is  $\pm 15$  meters (37.5 feet), with an average retreat rate of 4 meters (12 feet) per year (Hansen, 1986). The beachface dewatering system was installed along a 500 meter stretch of beach, after extensive pre-installation surveying of control (untreated) zones both upstream and downstream of the test zone. Extensive monitoring (beach profiling) of the control zones and test zone were carried out for well over a year. Operation of the system quickly stabilized the beach (halted the retreat) and advance of the beach (widening and raising) took place for several months until a balance was achieved with a significantly wider beach. Brief episodes of retreat caused by severe storms were quickly "healed" within days. Net change in the test zone -- total change in the treated zone minus the mean of the upstream and downstream control zone changes -- averaged more than 20 meters (more than 60 feet) as determined by a re-analysis of data from Hansen (1986), shown in Figure 10. The "storm event" in May, resulting in effective retreat back to the baseline, was quickly "healed", significantly sooner than within the control zones.

#### SUPPLY OF SAND AT NULL POINTS *4/2/86 3:10 PM*

On many barrier islands, beach retreat (net erosion) occurs at the "null point" (position of zero net littoral drift) near the midpoint of the island, while advance (net accretion) occurs at both ends of that island. At a null point, the same amount of littoral drift moves in one direction (for example, south) as moves in the opposite direction (for example, north), when summed up over a period of a year. The zero net movement is found by subtracting the total northward movement from the total southward movement. The "gross" or total littoral drift at that geographic point (the sum of drift to south and to north) is the important quantity to the action of STABEACH System. Even at a null point, the gross drift can be quite large, thus providing an adequate supply of sand on which STABEACH System can operate.

Where the null point results from zero drift in both directions, the STABEACH System may work by modifying the offshore bottom profile and allowing shoreward "bottom creep" of sand (driven by wave action) to bring that near-offshore sand to the beach where the system acts to hold it on the beachface. Normally, littoral drift will replenish that offshore sand. Seasonal changes in dominant wind direction may shift the location of the null point as much as several hundred yards or more, so that the spot that was a null point in summer will not be the null point in winter. Thus at some season, each spot along the beach will be away from a null point, and will have some supply of littoral drift sand.

## COMPARISON WITH CONVENTIONAL BEACH NOURISHMENT

Conventional beach renourishment involves rapid dumping of large volumes of "foreign" sand on the beach face or the near-shore area, literally burying the local endemic fauna and flora under many inches of sediment. Many attached, burrowing and slow-moving animals and plants cannot respond rapidly enough to this catastrophic disruption of their environment, and massive kills have occurred as a result. Environmentalist's objections on this basis have delayed and forestalled needed beach restorations.

In sharp contrast, the action of STABEACH System is gradual -- not any more sudden or catastrophic than the seasonal variations from a typical winter beach and offshore profile to a typical summer profile (Figure 9), which most plants and animals easily adjust to and survive. STABEACH System produces and maintains an enhanced summer profile (a wider and more gently sloping beach-face), using nearby nearshore sand -- the same "quality" of sand that is on the beach. STABEACH System does not increase turbidity as does conventional dredging for conventional beach nourishment, nor otherwise stress the local flora and fauna.

## MONITORING AT SAILFISH POINT

The success of the STABEACH System of beachface dewatering in stabilizing and building the beach at Sailfish Point can best be demonstrated by comparing the treated stretch of beach with untreated "control" stretches of beach both to the north ("upstream" relative to direction of net littoral drift) and to the south ("downstream") over a significant period of time. A beach profiling monitoring plan has been established. Twelve locations will be measured along traverses perpendicular to the beach, from the construction control line seaward to a water depth of 4 feet below mean sea level (MSL), on a biweekly schedule. Three profiles will be within the treated zone, five profiles will be located up to 1500 feet north of the midpoint of the treated zone, and four profiles will be located up to 1000 feet south of the midpoint. Three sets of profiles were measured before the installation of the system began in August, 1988. Figure 14 is a typical profile within the test section at Sailfish Point, showing normal summer fluctuations over a five week period.

To establish long term trends in beach changes after the STABEACH System is placed in operation, graphic plots such as Figure 10 will be constructed. In this plot, the average position of the MSL strandline (distance from a reference line based on the construction control line) of all control profiles is subtracted from the average position of the strandline in all test zone profiles for a given date, and this net difference (advance/retreat) is plotted against time on the X-axis. When the test accretes more than the control zones over a period of several months, and/or when the test zone rebuilds ("heals") the effects of storm erosion faster than the control zone -- then the effectiveness of the STABEACH System will have been demonstrated.

## DISCUSSION

The design and installation of a STABEACH System is site-

specific -- many factors must be taken into consideration. The method depends upon adequate permeability to allow drainage at a sufficient rate. Permeability depends upon particle size and sorting and the absence of clay/silt/organic layers. Other local factors that may contribute to the efficiency of operation are: wave climate, tidal range, slope of beach face, shape of offshore bottom profile, quality of offshore sand, quantity of gross (not net) littoral drift, and direction and frequency of storm events.

Conventional methods for beach restoration all have one or more of the following detrimental aspects: high cost, short life, unsightly physical structures, hazardous obstructions to leisure sports, side effects on downstream beaches, or other adverse environmental effects (for example, turbidity from dredging, disturbance of bird nesting or turtle egg-laying).

As demonstrated during years of extensively monitored testing in Denmark, beachface dewatering has no apparent disadvantages: it is price competitive with other comparably effective procedures, has a long life with moderate annual operation and maintenance costs, no unsightly or hazardous surface structures, no observed bad effects on downstream beaches, and no other known adverse environmental effects.

Installation of the STABEACH System requires dewatering of a stretch of beachface so that a ditch may be dug below mean sea level for the emplacement of the drain pipes. A map or plan view of a typical installation is shown in Figure 11. A diagrammatic cross section of the beach (Figure 12) shows the position of the STABEACH System installation. A longitudinal section (Figure 13), illustrates drainage by gravity from each end to a central sump and pump station. The output from the pump can be discharged out to sea, or as it is pure filtered seawater, may be used to "freshen" (oxygenate) stagnant inland lagoons or boat canals. A one thousand foot long module of STABEACH System may require disruption of the beach during installation for only a few weeks.

## CONCLUSIONS

A new high-technology, effective and efficient method for beach restoration and management -- the STABEACH System -- has been developed. Reports from Denmark and Namibia indicate excellent results from similar beachface dewatering systems. The method effectively stabilizes the beach, stops beach retreat, widens and builds-up beaches, and quickly "heals" storm erosion events. Comprehensive monitoring over several years at three installations in Denmark has demonstrated that downstream beaches do not suffer significant or measurable net erosion (retreat). No measurable negative environmental side-effects have been observed.

The first beachface dewatering system in the United States is now being installed at Sailfish Point, near Stuart on the Florida East Coast. This first STABEACH System is expected to be in operation by early September, 1988. Extensive beach profile monitoring is underway to demonstrate the effectiveness of the procedure. Significant savings in long-term costs are possible by combining partial beach nourishment with a STABEACH System installation to stabilize the beach and give the widened beach a longer life.

## REFERENCES

- Bagnold, R.A. (1940). "Beach formation by waves; some model experiments in a wave tank." J. Inst. Civil Engr., 15, 27-54.
- Bokuniewicz, H.J., and Schubel, J.R. (1987). "The Vicissitudes of Long Island Beaches, New York." Shore & Beach, 55(4), 71-75.
- Bruun, P. (1974). "Bypassing sediment -- plants and arrangements." The Dock and Harbour Authority, LV(645), July 1974
- CERC (1984). Shore Protection Manual. Coastal Eng. Res. Cent., U.S. Army Corps of Engineers, Vicksburg, Mississippi.
- Domurat, G.W. (1987). "Beach Nourishment - A Working Solution." Shore & Beach, 55(4), 92-95.
- Duncan, J.R. (1964). "The effects of water table and tide cycle on wash-backwash, sediment distribution, and beach profile development." Marine Geol., 2, 186-197.
- Edge, B.L., Czlupinski, R.E., and Schlueter, R.E. (1987). "A Comprehensive Approach to Beach Management." Shore & Beach, 55(4), 122-7.
- Emery, K.O., and Foster, J.F. (1948). "Water tables in marine beaches." J. Mar. Res. 7(3), 644-654.
- Grant, U.S. (1948). "Influence of the water table on beach aggradation and degradation." J. Mar. Res. 7(3), 655-660.
- Hansen, H. K. (1986). "COASTAL DRAIN SYSTEM: Full Scale Test - 1985, Thorsmindetangen." Summary Report Job 170 83322. Danish Geotechnical Institute, Lyngby, Denmark.
- Harrison, W. (1972). "Changes in Foreshore Sand Volume on a Tidal Beach: Role of Fluctuations in Water Table and Ocean Still-Water Level." Proc. 24th Int. Geol. Congr., sec. 12, 159-166.
- Harrison, W., Fang, C.S., and Wang, S.N. (1971) "Groundwater Flow in a Sandy Tidal Beach 1. One-Dimensional Finite Element Analysis." Water Resources Research 7, 1313-1322.
- Herron, W.J. (1987). "Sand Replenishment in Southern California." Shore & Beach, 55 (4), 87-91.
- Holland, J. (1972). "Beach Erosion Pipeline Urged." Philadelphia Inquirer, Sunday, June 4, 1972, 2-J.
- Inman, D.L. (1987). "Accretion and Erosion Waves on Beaches." Shore & Beach, 55(1), 61-66.
- Isaacs, J.D., and Bascom, W.N. (1949). "Water table elevations in some Pacific coast beaches." Trans. Am. Geophys. Union, 30(2), 293-4.
- Machemehl, J. L., French, T. J., and Huang, N. E. (1975). "New Method for Beach Erosion Control." Civil Engineering in the Oceans, 3rd Conf., University of Delaware, ASCE, 142-160.
- Pearson, D.R., and Riggs, S.R. (1987). "Relationship of Surface Sediments on the Lower Forebeach and Nearshore Shelf to Beach Nourishment at Wrightsville Beach." Shore & Beach, 49(1), 26-31.
- Rogers, S.M., Jr. (1987). "Artificial Seaweed for Erosion Control." Shore & Beach, 55(1), 19-29.
- State of Florida (1986). A Proposed Comprehensive Beach Management Program for the State of Florida, Tallahassee, Florida.
- Waddell, E. (1976). "Swash--groundwater--beach profile interactions." in: R.L. Davis and R.L. Ethington (eds), Beach and Nearshore Sedimentation, Soc. Econ. Paleontol. Mineral., Spec. Publ., 24, 115-125.
- Wiegel, R.L. (1987). "Trends in Coastal Erosion Management." Shore & Beach, 55(1), 3-11.

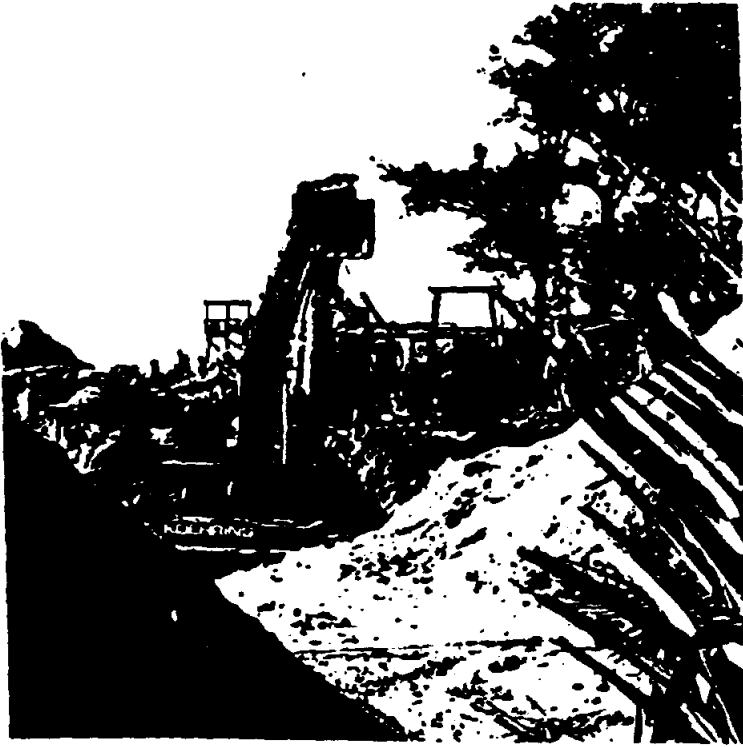

Fig. 1 - Power equipment in operation at Sailfish Point jobsite



Fig. 2 - Pump Station (vertical pipe) and temporary dewatering pump

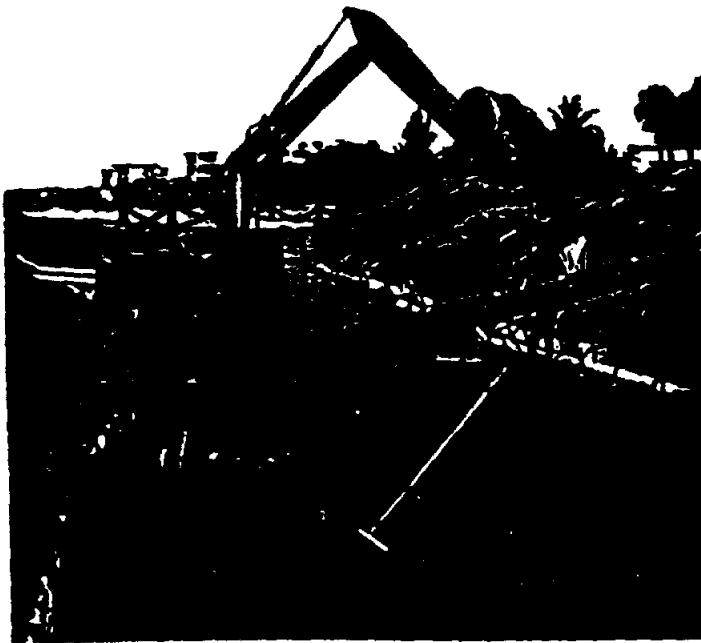
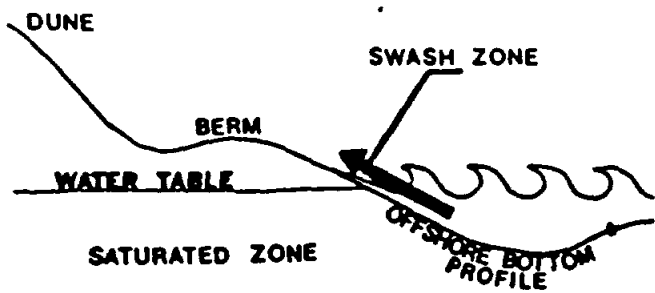

Fig. 3 - Installing the drain pipe in temporarily dewatered trench

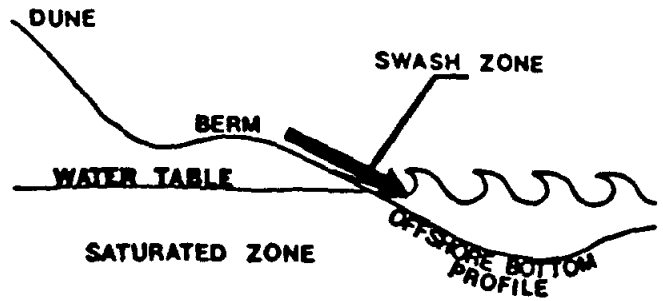

Fig. 4 - Sailfish Point Beach before operation of STABEACH System



BEFORE

Fig. 5 - Wave runup on beachface (normal water table)



BEFORE

Fig. 6 - Backwash on beachface (normal water table)

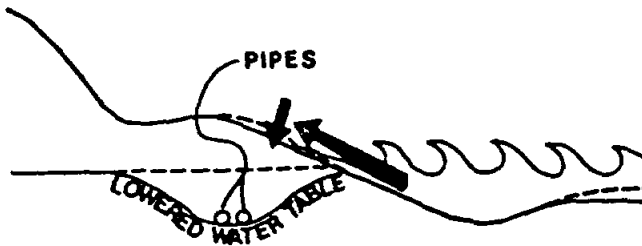

AFTER

Fig. 7 - Upwash and downward percolation with lowered water table

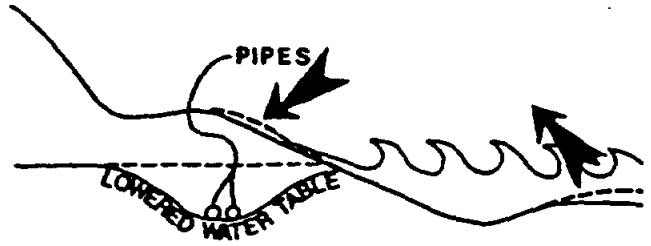

AFTER

Fig. 8 - Change in offshore bottom profile: sand from offshore bar is added to beach by action of STABEACH System

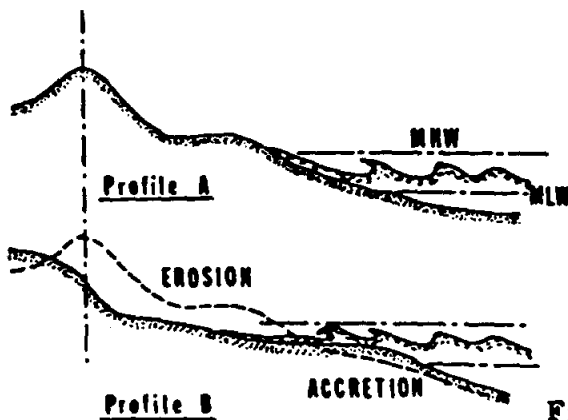

Fig. 9 - Profile A = summer  
Profile B = winter

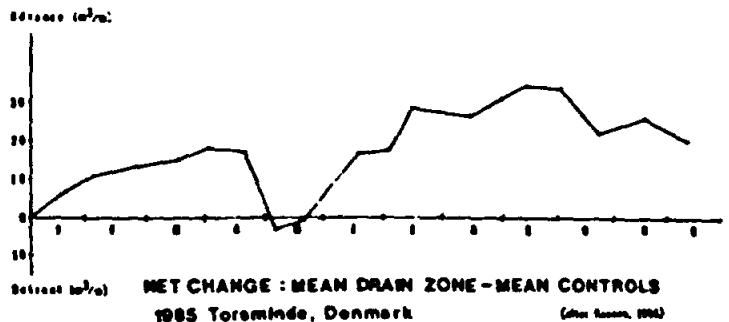

Fig. 10 - Net change (advance/retreat) in 198 at Torsminde, Denmark. Average of treated zone profiles minus average of all control profiles

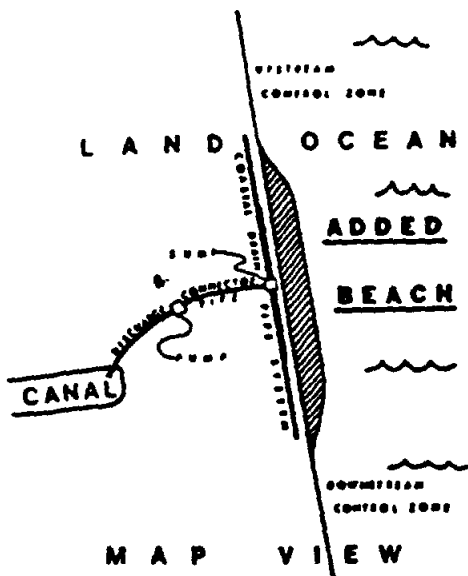

Fig. 11 - Diagrammatic plan (map) view of STABEACH installation

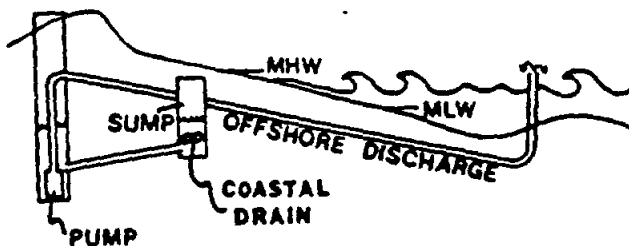

Fig. 12 - Cross-section perpendicular to beach trend of STABEACH System installation

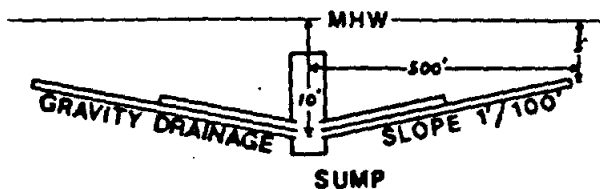

Fig. 13 - Longitudinal section parallel to beach (as viewed from sea) of buried pipes in relation to MHW on beachface



# SAILFISH POINT PROFILE

STATION 3+00S

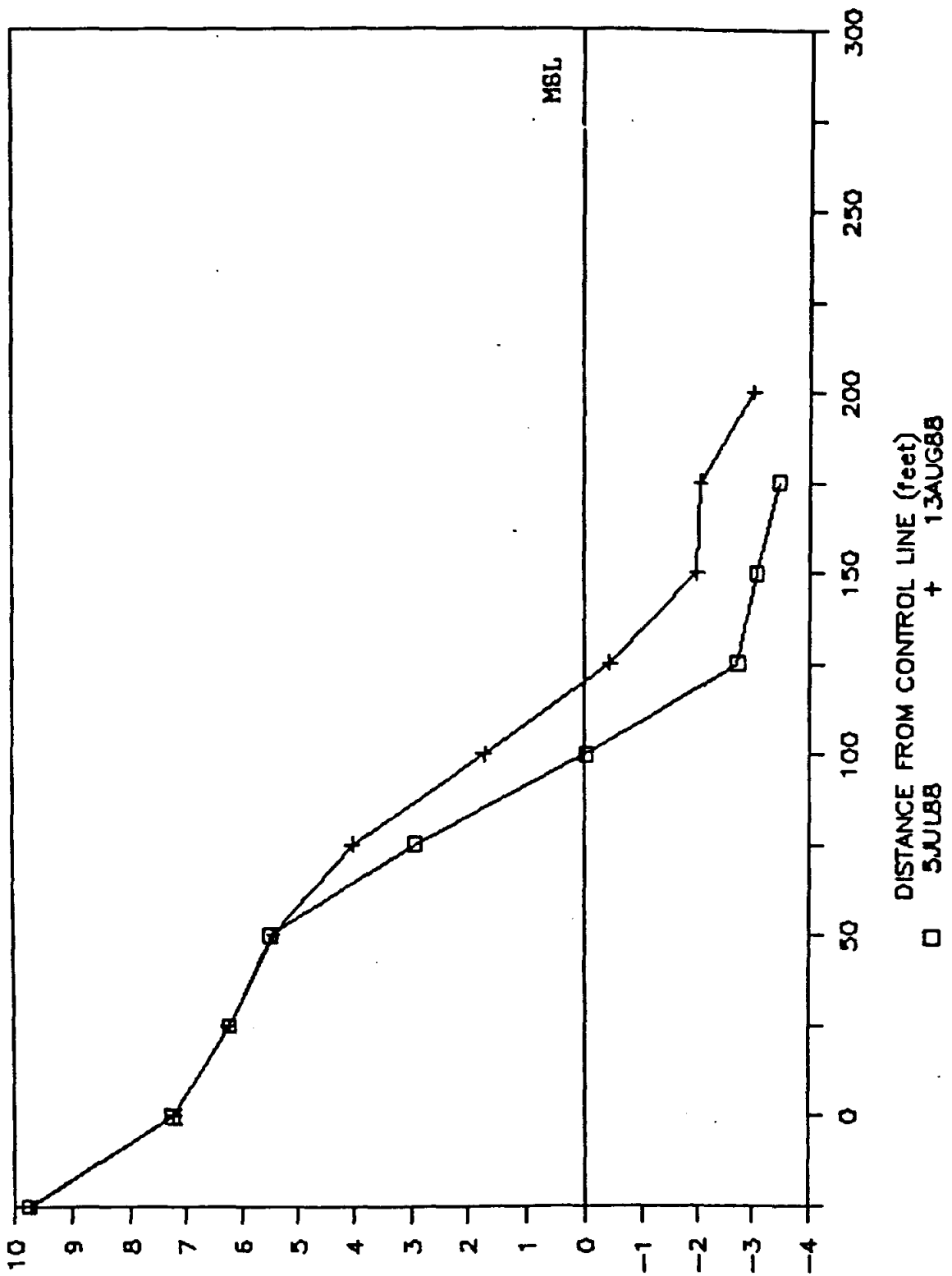

Fig. 14 - Typical beach profile at Sailfish Point before installation of the STABEACH System

# TEXAS A&M UNIVERSITY AT GALVESTON

MITCHELL CAMPUS • P.O. BOX 1675 • GALVESTON, TEXAS 77553-1675 • (409) 740-4504

Department of  
MARITIME SYSTEMS ENGINEERING

February 25, 1989

Mr. Raymond Reesby  
2701 Avenue O  
Galveston, TX 77550

Dear Ray:

Thank you for stopping by TAMUG and lending me the coastal stabilization literature by Dr. James M. Parks. I have reviewed the literature package and am enclosing my comments regarding the STABEACH SYSTEM with this letter as you requested

I look forward to seeing you in the upcoming meeting at the Moody Center on March 1.

With my warmest personal wishes.

Sincerely,

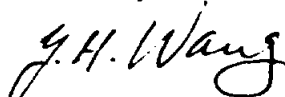

Y. H. Wang, P.E.  
Professor

Enclosure:

xc: Mr. Pat. Hallisey  
Mr. Russell Eitel

**COMMENTS ON THE STABEACH SYSTEM**  
(A dewatering approach to beach stabilization)  
February 25, 1989

**A. The fundamental base:**

"Wave uprush brings sand onto the beach -- and the returning backwash takes sand off the beach. Dewatering the beachface retards that second stage of taking sand off the beach, thereby leaving additional sand on the beach."

This statement of Dr. James M. Parks sounds reasonable to me. However, the statement has the following limitations:

1. The sand deposits are confined in the swash zone which is a very small part of the beach face.
2. The process of sand deposit within the swash zone can not continue to grow beyond the natural beach slope. Therefore, the amount of deposit is just a small volume to make the beach face look a little fuller.
3. The beach face can not be widened by the proposed method as one might be misled by the figure 11 and the statement on page 4, second paragraph from the bottom.
4. In the figure 14, the large amount of sand accumulation is below the mean-sea-level (MSL), not the swash zone. One possible explanation for this is: The bottom profile changes with changing energy input (wave, tide, current, etc.) to the surf zone, not because of the dewatering system.

**B. Possible down side of the Stabeach System:**

Referring to figures 7 & 8, the lowered water table in the landward direction may extend further inland beyond the dune line. This may have negative impacts on land vegetation growth and affects the dune line ecology.

**C. How does the Stabeach System work for Galveston Island?**

Galveston shore is a low energy coastline. The differences between the summer and winter profiles are not as great as the figure 9 may have implied. Galveston shoreline is much more different from that of Denmark and Namibia.

Granting the Stabeach System will put and keep a layer of sand in the swash zone during most of the winter season similar to the situations in figures 7 & 8. But there is no noticeable beach face erosion complain in Galveston. The beach erosion problems in Galveston are duneline losses, land losses, and beach width narrowing. The proposed Stabeach System can not help in any one of the problems unique to Galveston shores.

**APPENDIX C**

**MAC-BLOX**

**AN ENERGY ABSORBING REVETMENT**

Technique for Shoreline Erosion Control  
Donald R. McCreary  
Mac-Blox Corporation

INTRODUCTION:

"Good morning ladies and gentlemen..... I am here to tell you about a very unique system for shoreline stabilization. The Mac-Blox Sloping Revetment System was developed in the Tampa Bay Area of Florida, beginning in the fall of 1989. It has been successfully applied there, to many shoreline problems that we have in common with the Galveston Bay Area. It is first and foremost a system of great strength, stability, and permanence. Yet it has environmental features that are so favorable that it is frequently considered as part of the environmental mitigation solution; rather than as part of the problem."

WHAT IS MAC-BLOX ???

Well, here is a scale model of one Mac-Blox. (SHOW MODEL)  
A "real live Mac-Blox" is made of concrete and weighs 300 pounds. These blocks are placed to form a step-like sloping revetment; and then locked together with concrete shear piling in groups of ten or more. The best way I can describe it quickly, would be to say that it is an engineered solution to many problems created by eroding shorelines and/or vertical seawalls. It is designed to do two things:

1. Reinforce an existing seawall
2. Stabilize an eroding shoreline

In both cases, it does these things by creating a step-like sloping revetment. It is similar to rip-rap rock revetments, except that it consists of these large, specially designed concrete blocks, which have a number of significant advantages over the rock structures.

WHAT IS MAC-BLOX NOT ???

To avoid a very common misperception, let me diverge for just a moment to tell you what Mac-Blox is NOT!!!! It is NOT a block system for surface armoring of relatively flat slopes, above the waterline. The "woods are full" of this type of block system; I am sure most of you are familiar with them.

Nor is Mac-Blox the same thing as the landscape blocks that you have seen used for planters and other near-vertical upland terraces. The Mac-Box System is a different animal entirely from any of these!!!! It is much heavier, deeper, and stronger; and it is designed to live and work in the incredibly harsh and corrosive "SPLASH ZONE" where wave energy crashes into shorelines and destroys most other structures.

## BASIC PRINCIPLES OF SHORELINE STABILIZATION:

In recent years, the ideal shoreline structure for absorbing wave energy has been defined as having three important characteristics

1. Sloping - so waves do not slam, rebound, and cause erosion
2. Rough - to impede and diffuse wave runup/rundown.
3. Internal Spaces - to absorb and cushion wave energy.

These are also important from an environmental perspective, because these same spaces provide habitat and shelter for marine plants and animals.

Mac-Blox has incorporated all three characteristics in it's basic design.

Other, equally important design characteristics were drawn directly from the technology of rock structures that have proven themselves in countless applications throughout the world:

1. Density of the solid mass - concrete is very close to rock
2. Ratio of solid mass to internal spaces - approx. 80/20
3. Slope Ratio - 2 horiz / 1 vertical for geometric stability

## EXISTING TECHNOLOGY:

By far the most common attempt to stabilize shorelines in shallow coastal areas has been the use of vertical seawalls; usually of steel reinforced concrete. The Tampa Bay area of Florida where I live, is one of the most heavily seawalled areas in the world. Unfortunately these vertical seawalls violate most of the desirable parameters listed above. In addition, the uncoated steel reinforcement that was used in most of these walls ; in the corrosive environment of a salt water "splash zone" was a prescription for failure.

These failures are now occurring at an alarming, and geometrically increasing rate. The basic premise of Mac-Blox is that it doesn't make good sense to temporarily patch these things up with tieback rods, and/or other "band-aid" type approaches. This only perpetuates the basic problem, which is the verticality of the structures. When we have to fix them, why not convert them to a permanent sloping revetment ; which is the way we should have been building them in the first place?

There is much more I could tell you about Mac-Blox, but I subscribe to the theory that a picture is worth a thousand words, so let me show you some, and I will explain as we go. Then we can discuss any questions that you may have.

HERE SHOW SLIDES, VIDEO, TRANSPARENCIES, ETC.

THE BALANCE OF THIS IS TO BE COVERED DURING  
SLIDE PRESENTATION AND DISCUSSION

PROBLEM OF OLDER VERTICAL SEAWALLS:

Most knowledgeable people in the industry are aware of the huge problem that exists in most coastal areas, with respect to older vertical seawalls, especially those of reinforced concrete. These are caused by two basic problems with the way we have been building seawalls for the last forty or fifty years:

1. Wave action slamming and bouncing against vertical walls causes turbulence, erosion, water turbidity, and a fairly sterile, unproductive aquatic environment.
2. Highly stressed reinforced concrete, in a salt water environment, has very limited useful life because of oxidation/expansion of the reinforcing steel, and the subsequent breakdown of the structure.

"BAND-AID SOLUTIONS VS SLOPING REVETMENTS:

There are a number of temporary "band-aid" type approaches being applied now to patch these things up in a fairly primitive, labor intensive way. None of these represent a satisfactory long range solution, and none of these do anything to correct the basic problem of vertical walls.

In the larger picture, there is no doubt that sloping revetment systems are going to replace vertical seawalls, in the vast majority of cases. This has already happened with respect to new seawalls. Very few new vertical seawalls are being permitted now, without the protection of sloping revetments, but there are huge numbers of older seawalls that are nearing the end of their useful lives and should be converted. When the marginal cost of this permanent solution is very small, the temporary solutions do not make a great deal of sense. In many areas, it is likely that repairs involving sloping revetments will be mandated in the near future.

PRO SLOPING (ROCK) REVETMENTS:

For about the last fifteen years, the marine construction company of which I have been President, has been promoting the idea of sloping revetments as the most comprehensive solution to the problem of vertical seawalls. We have been using rip-rap rock for these revetments, because it was the only material that was practically available at the time. The rip-rap rock advantages over all other methods include simplicity, permanence, great structural strength, and good environmental qualities.



#### MAC-BLOX IMPROVEMENTS:

The Mac-Blox System began with all of the well proven physical characteristics of rock structures, and added modern materials, structural integrity, great logistical advantages, cleaner appearance, user safety, and even better environmental qualities.

#### ENVIRONMENTAL FEATURES:

Mangroves, spartina, and similar plants, as well as many forms of small marine animals, thrive within the protection of the carefully designed internal spaces of the Mac-Blox System, these were very carefully developed, with input from regulatory and environmental agencies, to have all the desirable physical characteristics of rip-rap, and to improve upon rip-rap in all of these areas.

#### HOW AND WHY DEVELOPED:

I am the inventor of, and hold the Patent, (currently pending) on the MAC-BLOX Sloping Revetment System, which was developed in St. Petersburg, Florida, beginning in 1989. This was after 26 years of experience in the marine construction business, being especially involved with many rock jetties, revetments, groins, seawalls, bulkheads, weirs, docks and other types of structures in the water/land marginal area. This development was in response to increasing demand for sloping rip-rap revetments and seawall protection, in locations which were inaccessible for the heavy equipment required to install the rip-rap rock.

#### EXCEEDS REGULATORY REQUIREMENTS:

From the beginning, the MAC-BLOX System was developed to be fully in compliance with both the requirements and preferences of knowledgeable regulatory agencies and environmental consultants. Many of these characteristics came directly from Florida DER requirements for unconsolidated rip-rap ; such as the 2:1 slope, (horizontal slope distance twice vertical slope distance), which is built into the modular MAC-BLOX System. The overall solid mass, vs interior spaces ratio, is the same as DER, and Corps of Engineers approved rip-rap rock structures. The MAC-BLOX System presents a very "rough" sloping surface to approaching waves, and this together with the carefully designed, interconnecting interior spaces, dissipates wave energy in a way that is superior even to the rip-rap rock.

#### MODULAR CONCEPT:

The Mac-Blox System is a modular concept. From the beginning I have envisioned that the block size would probably be scaled up, (or perhaps down), for different applications. The size figures I gave you earlier are for the "standard" block, which works well for the great majority of low-to-medium energy environments. This is the only size that has been produced to date, because of the ability to lock them together in large groups for different applications. I have had discussions with a very well known testing facility, to explore the parameters of the system for higher energy applications; but to date this has not been done. If we were to use the system out here, (THIS BEING TEXAS AND ALL) I am sure that the blocks would have to be BIGGER here!!!!

#### STRUCTURAL INTEGRITY AND PERMANENCE:

By far the most important factor for anyone considering a shoreline stabilization system, is structural integrity and long range security. The MAC-BLOX System is designed on the same simple, dependable, low stress structural principles that have been developed and proven on an empirical basis with the rip-rap rock. The MAC-BLOX are built entirely using modern Fibermesh Concrete. There is no steel to rust, expand, and crack the concrete. In addition, The cast-in place shear piling of the MAC-BLOX System provide quality-controlled structural integrity that is superior to the random interlocking of the rip-rap rock.

#### AESTHETICS AND SAFETY VS RIP-RAP:

In talking to many potential customers concerning sloping revetments of rip-rap rock, I have encountered significant market resistance in the areas of aesthetics and user safety. Regardless of the engineering and practical aspects involved I have had many people tell me that they simply do not want a sloping revetment of rip-rap in front of their seawall because of the appearance and the fact that it tends to accumulate flotsam trash. This is aggravated by the danger of falling and/or severe leg injuries resulting from trying to walk on the irregular surfaces. I have heard of at least one recent lawsuit concerning such an injury. In this case damages are being sought from a regulatory agency, for mandating a rip-rap revetment at a public park.

The attractive mosaic appearance of the Mac-Blox System, and the flat step-like surfaces are dramatic improvements over the aesthetic and safety features of the rip-rap rock. These features alone have given Mac-Blox a tremendous edge with engineers who are specifying jobs that will have public access.

COST EFFECTIVENESS:

When I mentioned before my 26 years experience in the very cost competitive field of marine construction --- I did so not merely to bore you to tears ---- but to give you an idea of where I was coming from when I designed the Mac-Blox System. In researching the "existing art" for my patent application, I came across some of the most elegantly designed and interesting "gadgets" that you can imagine. Unfortunately most of them were very impractical from the standpoint of cost effectiveness.

In order for an idea to be successful in the competitive marketplace, it must be designed for efficient manufacture and efficient installation. The final result must compare favorably with alternative solutions, and must give good value for every dollar spent.

At present, I am aware of no directly competitive system, and Mac-Blox has a very broad "Method Patent" which should preclude this for many years. I believe that it is important to maintain control of where and how it is used because the potential damage to this or any other new system from bad applications, is enormous. The closest thing to direct competition would be a sloping revetment of rip-rap rock. In some conditions, rip-rap rock is slightly cheaper than Mac-Blox. However Mac-Blox can be produced efficiently in a wide range of job conditions in which rock is cost prohibitive.

When you consider the Mac-Blox Bonuses:

Structural Integrity

User Safety

Aesthetics

Environmental Features

Mac-Blox meets the challenge of Cost Effectiveness very well!

SPECIFIC APPLICATIONS AND DESIGNS TO DATE:

(SHOW SLIDES & DRAWINGS)

SUMMARY:

Mac-Blox is proving to be an environmentally responsible solution to many of our shoreline problems in Tampa Bay and other areas of Florida. Many of the same problems exist in Galveston Bay, and I believe that this system would also be of great value here. I would be happy to make it available, and to work with those of you who are interested in specific applications in this area; or who might wish for more information on the System.

Thank you for your kind attention. I would also like to express my thanks to Dr. Wang for his interest, and for the invitation to speak to you here today.

# MAC-BLOX™ (THE SEAWALL SOLUTION)

A MODULAR SYSTEM OF CONCRETE RIP-RAP BLOCKS DESIGNED FOR:

1. REINFORCING EXISTING SEAWALLS
2. CONSTRUCTING NEW SEAWALLS WITH INTEGRAL SLOPING REVETMENT
3. STABILIZING A SHORELINE WITHOUT A VERTICAL SEAWALL

VERTICAL CYLINDRICAL SPACES IN CENTER OF BLOCKS MATCH SUCCESSIVE LAYERS AND ARE USED FOR SHEAR PILING WHICH LOCK THE LAYERS TOGETHER.

FLAT SURFACES TOP AND BOTTOM FOR COST-EFFECTIVE PRODUCTION AND SAFE SURFACES FOR WALKING ON THE FINISHED REVETMENT.

MULTI-FACETED, ROUGH, SLOPING SURFACE IS PRESENTED TO WAVE ENERGY APPROACHING FROM ANY ANGLE. IDEAL FOR BEST ENERGY ABSORPTION.

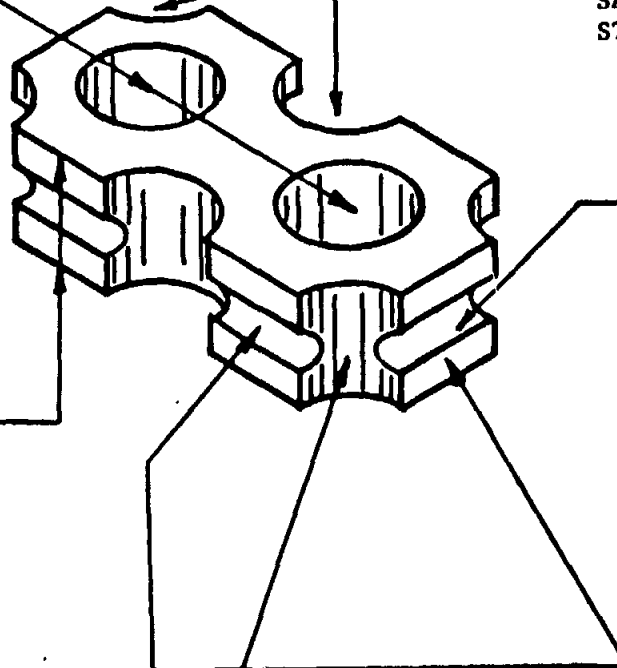

PERIMETER SHAPES MATCH WITH ADJACENT UNITS TO CREATE INTERNAL SPACES FOR:

1. ANIMAL HABITAT
2. PROTECTED GROWING SPACE FOR MARINE PLANTS
3. HYDRAULIC SURGE SPACES FOR ABSORBING WAVE ENERGY

SAME AMOUNT OF INTERNAL SPACES AS NATURAL STONE REVETMENTS.

HORIZONTAL GROOVES FOR COMMUNICATION BETWEEN VERTICAL CYLINDRICAL SPACES.

MODULAR SYSTEM RESULTS IN IDEAL 2H : 1V SLOPING REVETMENT WITH ROUGH SURFACE AND INTERNAL SPACES TO ABSORB WAVE ENERGY, AND PREVENT EROSION OF BOTTOM MATERIAL.

MAC-BLOX CORPORATION

STANDARD BLOCK FEATURES

4/19/90

DRY

ISLA KEY CONDOMINIUM - PINELLAS BAYWAY - ST. PETERSBURG, FLORIDA

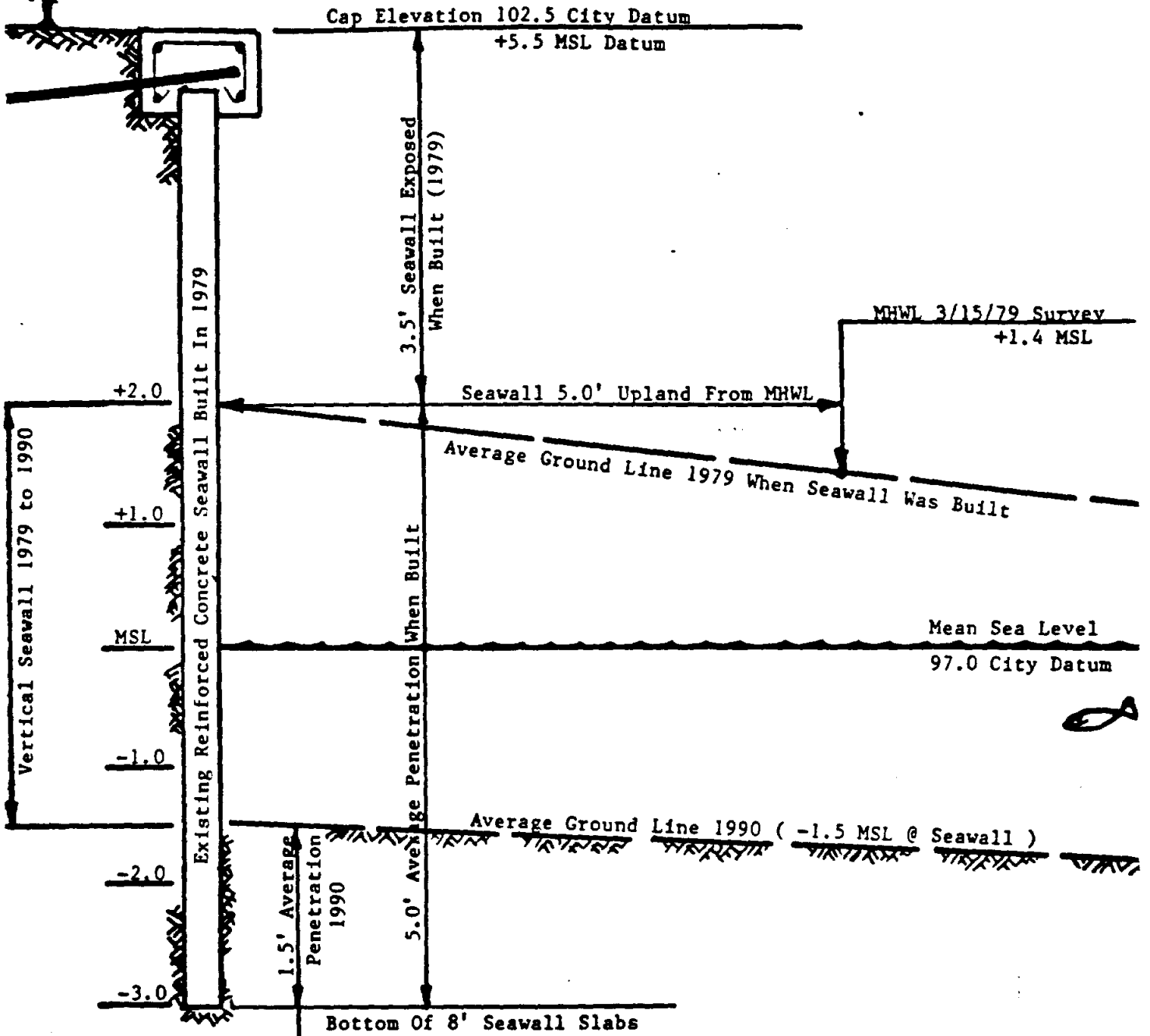

City Standards Require 40% Of Seawall Height = 3.4' Minimum Tieback System, Slab Reinforcement, And Other Structural Elements Also Designed For 3.4' Minimum Penetration.

SEAWALL SYSTEM HAS BECOME SEVERELY OVERSTRESSED DUE TO EROSION OF THE GROUND AT THE FACE OF THE VERTICAL SEAWALL. EROSION IS LIKELY TO CONTINUE AND FAILURE COULD OCCUR AT ANY TIME.



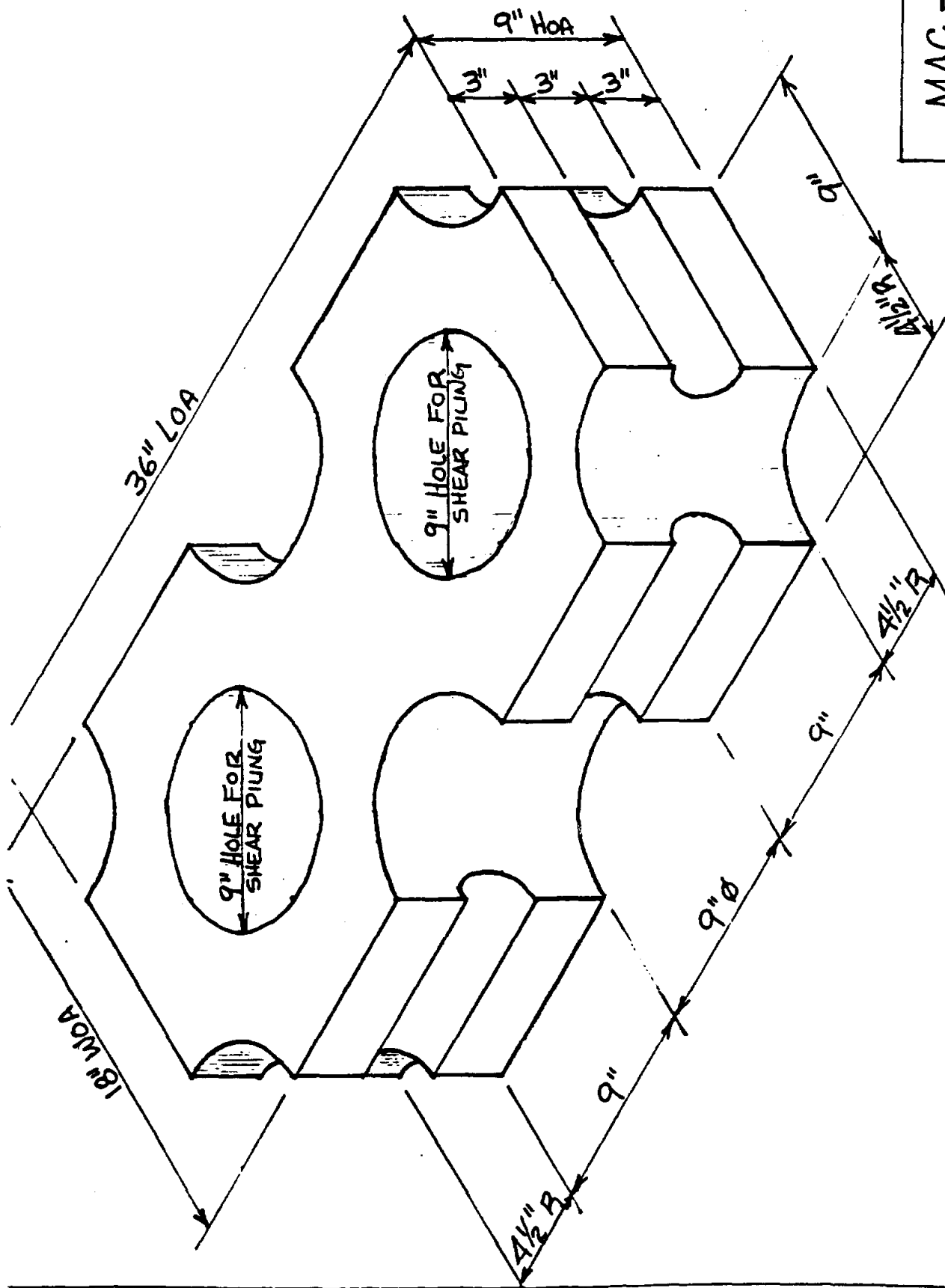

MAC-BLOX  
(PATENT PENDING)  
3/16/90 DRM

NOTE: THE MAC-BLOX SYSTEM IS MODULAR. ALL DIMENSIONS MAY BE SCALED UP OR DOWN. BLOCK AS SHOWN WEIGHS APPROXIMATELY 300 POUNDS.

# MAC-BLOX JETTY/GROIN SECTIONS

INTERCONNECTING INTERIOR SPACES (VERTICAL AND HORIZONTAL)  
FOR DISSIPATING WAVE ENERGY AND PROVIDING HABITAT  
FOR MARINE LIFE

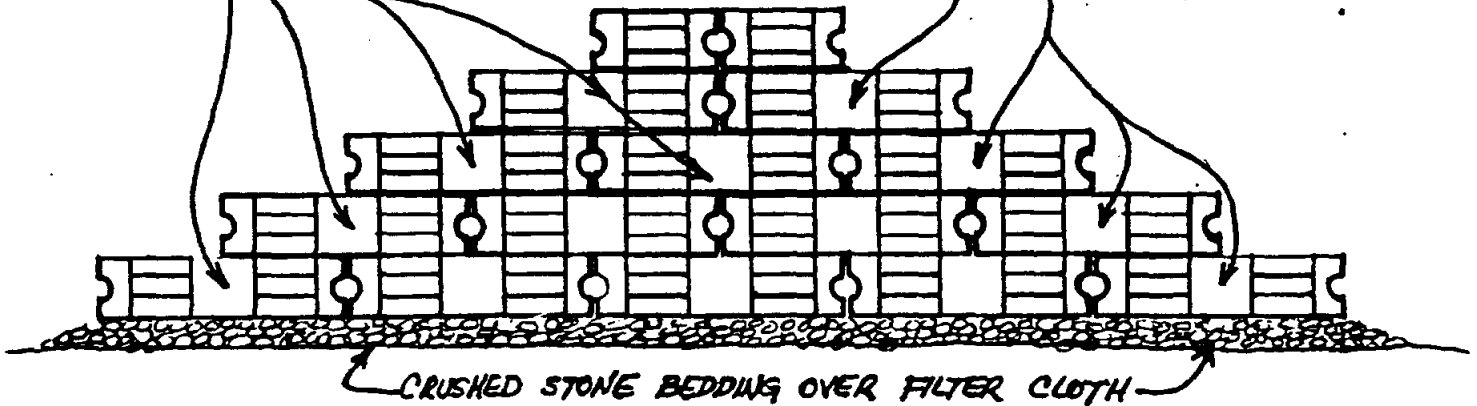

TYPICAL CROSS SECTION AT PERIMETER OF MAC-BLOX

SHEAR PILING HOLES FILLED WITH CRUSHED STONE

SHEAR PILING HOLES IN MAC-BLOX  
CAST IN PLACE WITH  
FIBERMESH CONCRETE

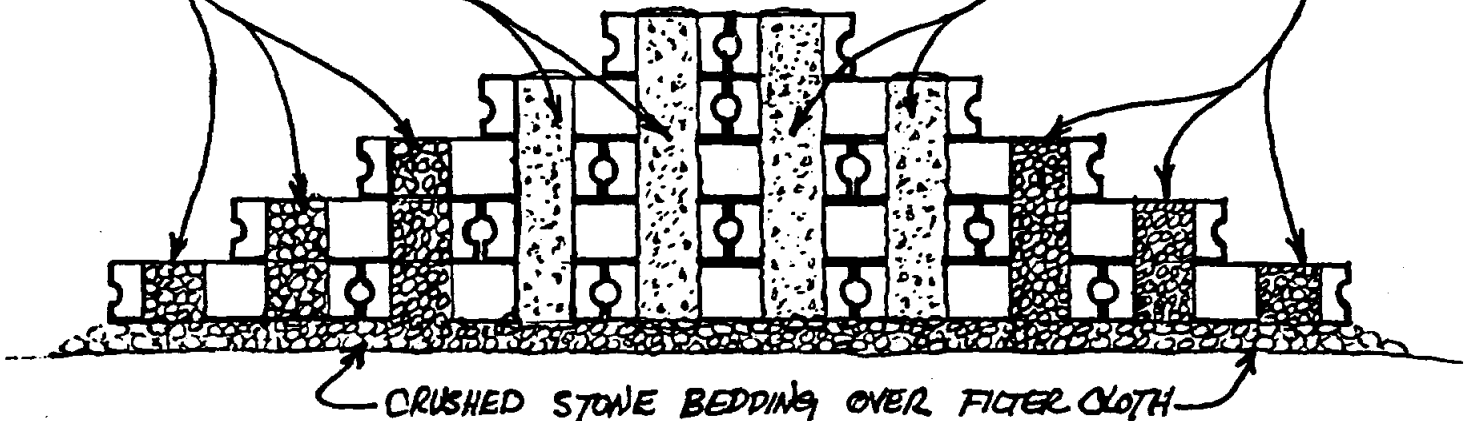

TYPICAL CROSS SECTION AT CENTER OF MAC-BLOX

MAC-BLOX  
(PATENT PENDING)  
3/9/90 DRM  
SBHJ/g



NEW MAC-BLOX SEAWALL SYSTEM  
(SLOPING REVETMENT BUILT-IN)  
COMPOSITE SECTION 5BHCW  
MAC-BLOX CORP. 9/17/91 DRM

PROPOSED FOR THE CITY OF WEST PALM BEACH  
NORTH FLAGLER DRIVE AT CURREY PARK

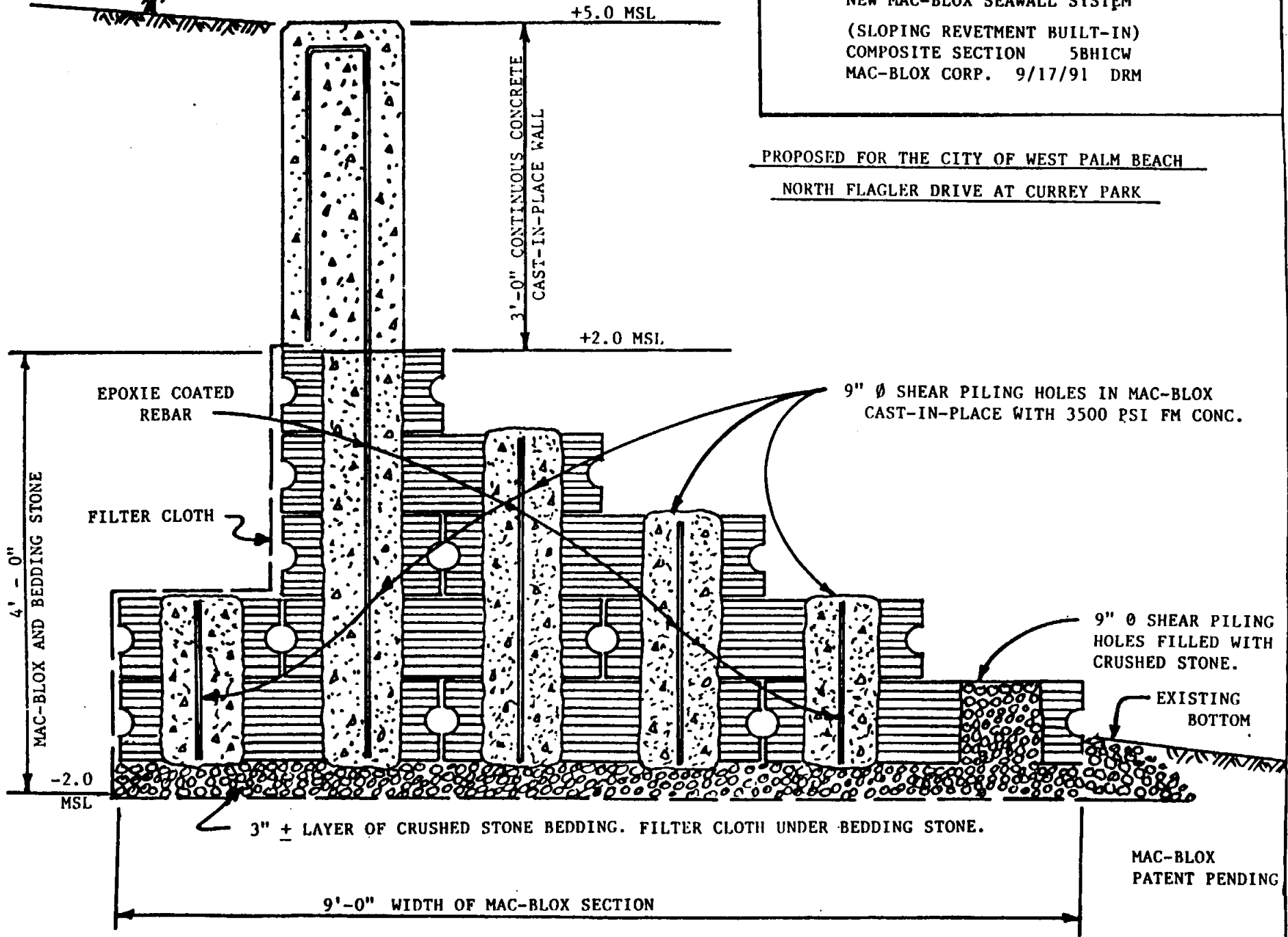

+5.0 MSL

3'-0" CONTINUOUS CONCRETE  
CAST-IN-PLACE WALL

+2.0 MSL

EPOXIE COATED  
REBAR

FILTER CLOTH

9" Ø SHEAR PILING HOLES IN MAC-BLOX  
CAST-IN-PLACE WITH 3500 PSI FM CONC.

4' - 0"  
MAC-BLOX AND BEDDING STONE

9" Ø SHEAR PILING  
HOLES FILLED WITH  
CRUSHED STONE.

EXISTING  
BOTTOM

-2.0  
MSL

3" + LAYER OF CRUSHED STONE BEDDING. FILTER CLOTH UNDER BEDDING STONE.

9'-0" WIDTH OF MAC-BLOX SECTION

MAC-BLOX  
PATENT PENDING

MAC-BLOX SLOPING REVETMENT RETAINING WALL

PROPOSED FOR BEN T. DAVIS PARK - TAMPA, FLORIDA PARKS DEPARTMENT

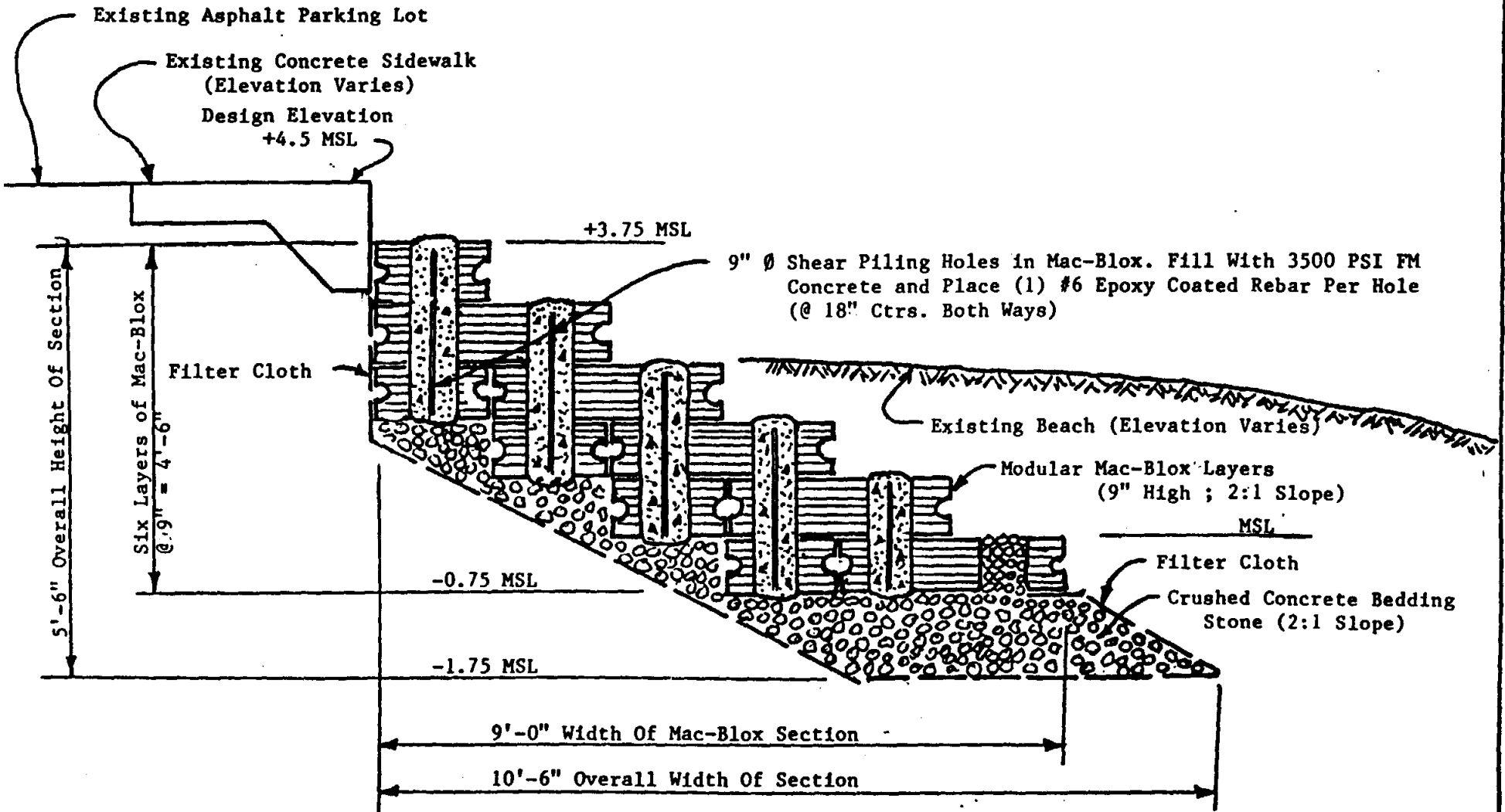

MAC-BLOX SLOPING REVETMENT RETAINING WALL

PROPOSED FOR SILVER SANDS CONDOMINIUM - ST. PETERSBURG BEACH, FLA.



Mac-Blox Patent Pending

MAC-BLOX CORPORATION

Standard Section

4BH27CW

3/21/91

DRM

MAC-BLOX SLOPING REVETMENT RETAINING WALL

PROPOSED FOR ST. PETERSBURG BEACH EGAN PARK

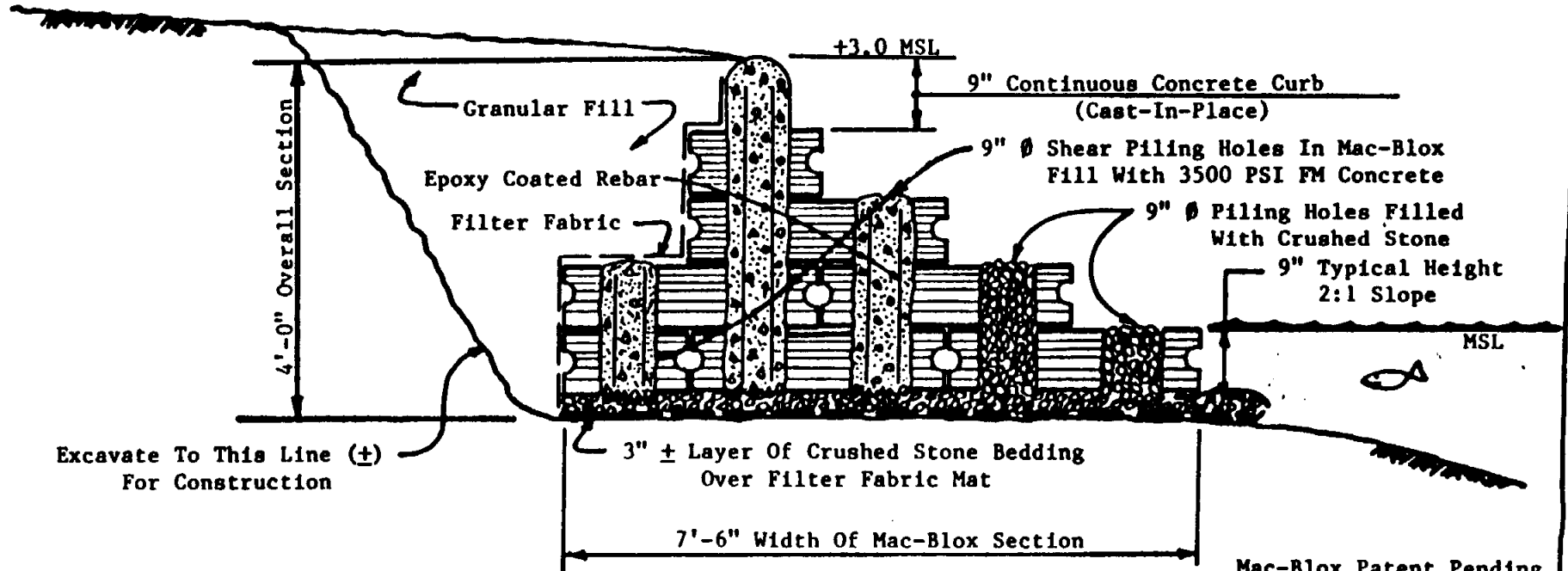

<u>MAC-BLOX CORPORATION</u>	
Standard Section	4BHICRB
7/3/90	DRM

# MAC-BLOX RIP RAP SYSTEM PLAN

17900-17964 U S HIGHWAY NORTH  
CLEARWATER, FLORIDA

RAISE EXISTING CURB 6'  
FOR 10' ON EACH SIDE  
OF RIP RAP TO CONTROL  
RUN OFF

EXISTING ASPHALT  
PARKING LOT

4' THICK CONCRETE  
INFILL BETWEEN EXISTING  
CURB AND MAC BLOX

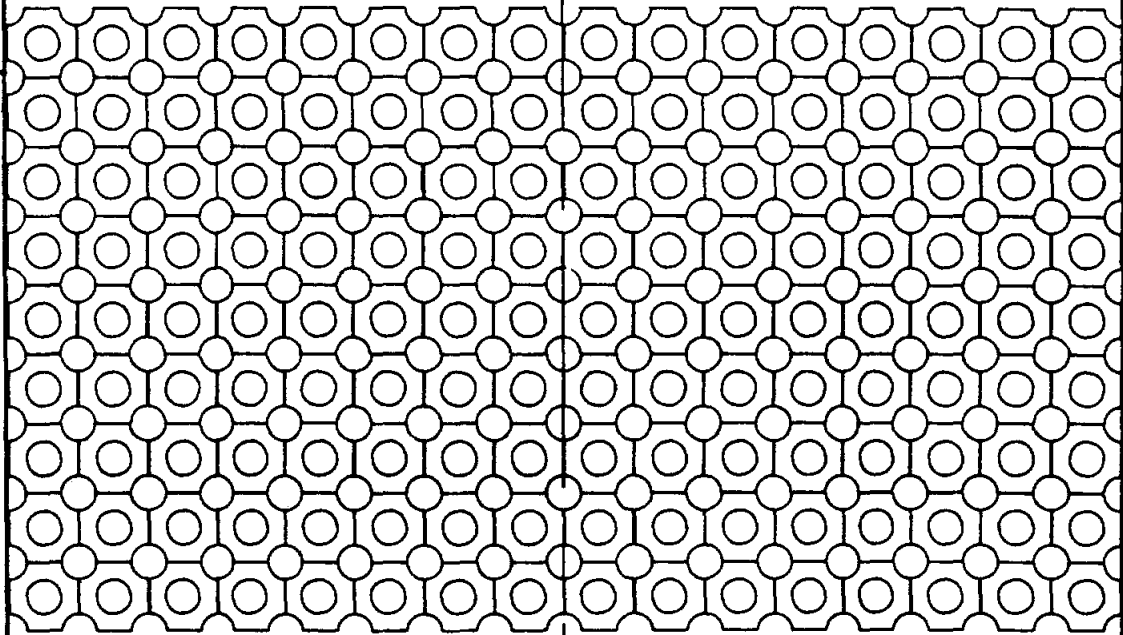

12'-0"

12'-0"

# MAC-BLOX RIP RAP SYSTEM SECTION

17900-17964 U S HIGHWAY NORTH  
CLEARWATER, FLORIDA

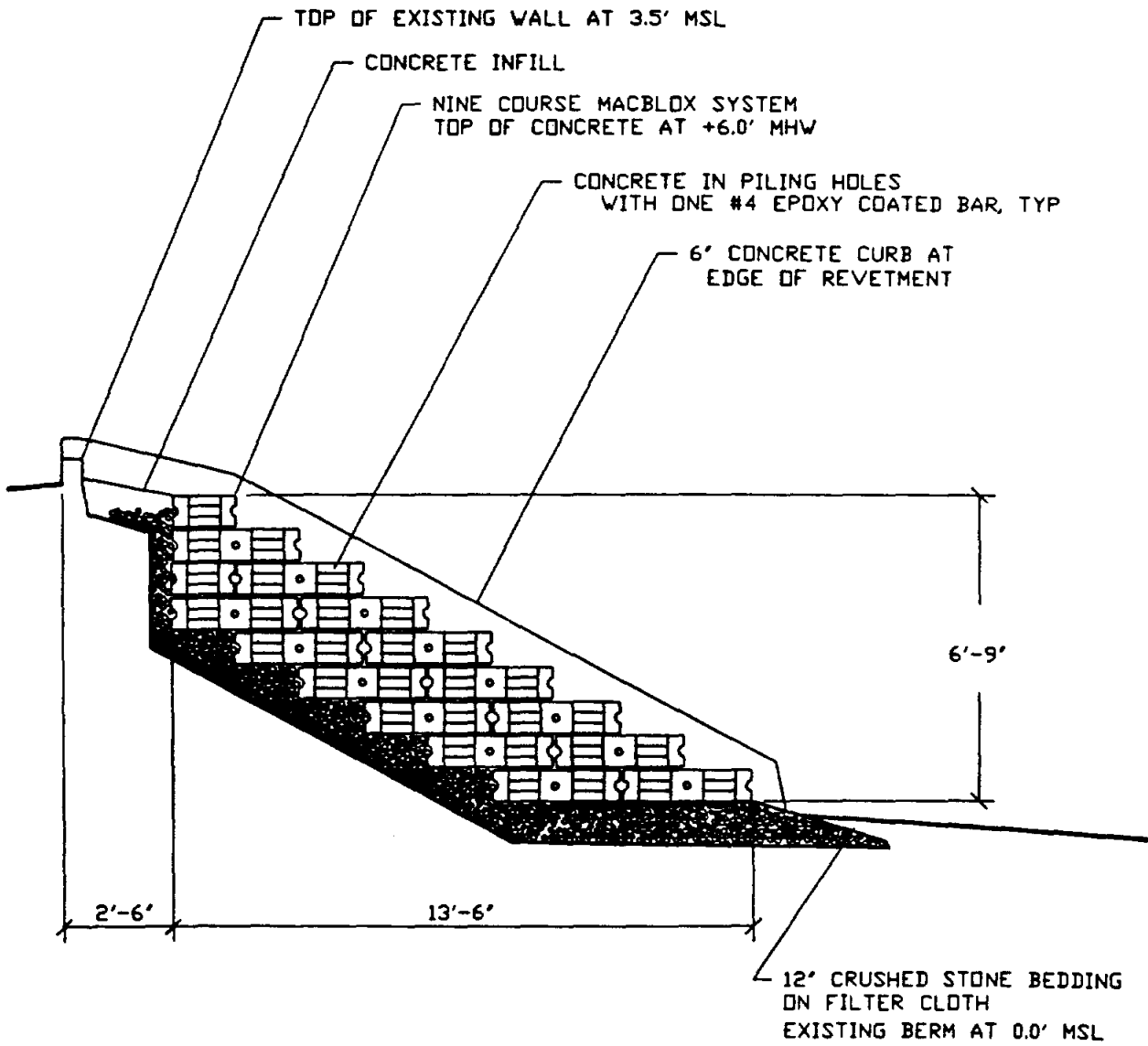

LOT 20  
NORTH EAST PARK SHORES  
SECOND ADDITION  
BLOCK 4

1191 42ND AVENUE N.E.  
ST. PETERSBURG, FLORIDA



SCALE: 1' = 20'

LOT 21

PLACIDO BAYOU

LOT 20

PROPERTY LINE 152.99'

FOUR COURSE  
MACBLOX REVETMENT  
T.O.C. AT 2.3' MSL

EXISTING SEAWALL CAP  
TOP OF CONCRETE  
AT APPROXIMATELY  
3.5' MSL

LOT 19

STEP DOWN  
MACBLOX  
AT END OF  
REVETMENT, TYP.

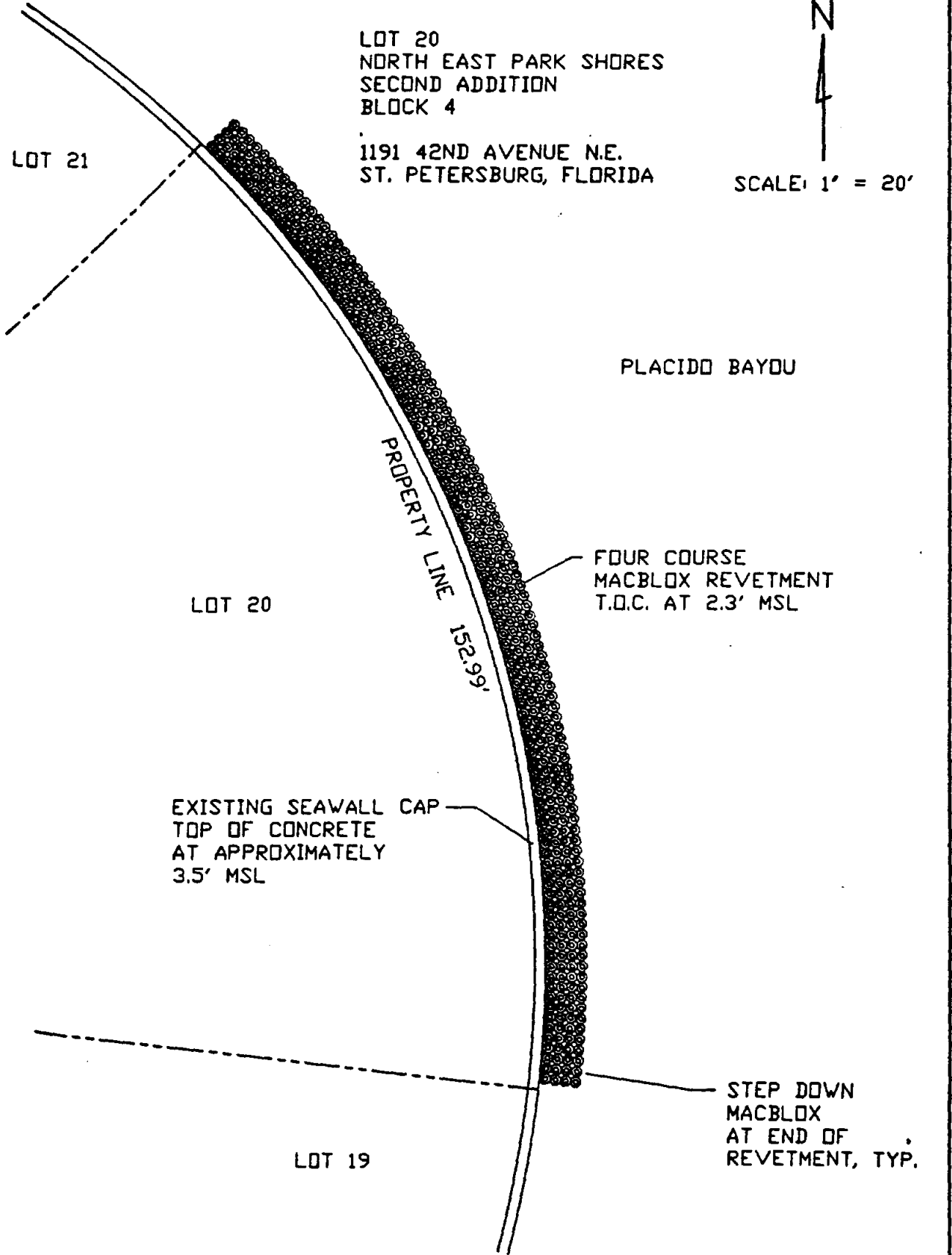

# MAC-BLOX RIP RAP SYSTEM SECTION

1020 FRIENDLY WAY SOUTH  
ST. PETERSBURG, FLORIDA

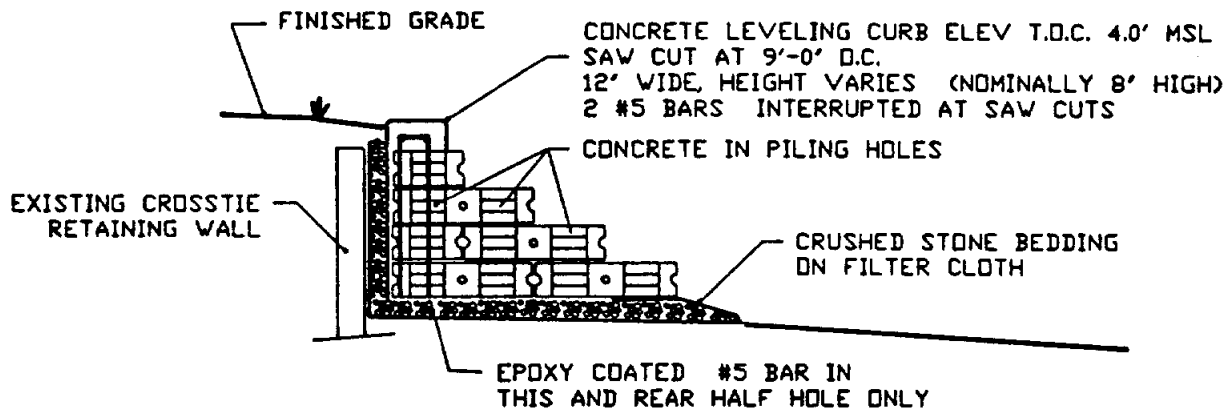



APPENDIX D

HORIZONTAL DEWATERING SYSTEM

# An Introduction To HDSI and



## Beach Preservation Cape Coral, Florida



A Division of H.D.S.I.

A Unique Groundwater Recovery System

**Donald R. Justice**  
President

P.O. Box 150820  
Cape Coral, FL 33915

(813) 995-8777  
Fax (813) 995-8465

## Beach Preservation Systems

---

### Table of Contents

- An Introduction to HDSI
- How Does HDSI's Beach Preservation System Work?
- What Are the Advantages of HDSI's Beach Preservation System?
- Quotes on the Benefits & Advantages of HDSI's Beach Preservation System
- Schematics of HDSI's Beach Preservation System

## Horizontal Dewatering Systems, Inc.

---

Horizontal Dewatering Systems, Inc. (HDSI) is a Florida corporation organized in May of 1987. Though still a young company, HDSI's founder, Donald R. Justice, has more than 30 years of proven success in the underground construction industry.

HDSI's initial efforts were directed at developing a cost effective dewatering system for that industry. However, those initial efforts soon evolved into a new technology that replaces the traditional, vertical wellpoint dewatering systems that have dominated the construction industry for decades.

This new technology, called the Horizontal Well, is currently extracting non-potable, surficial aquifer ground waters from depths up to 20 feet. In less than 12 months, improved equipment designs will allow HDSI to work at depths of 25 feet. However, HDSI has already proven not only to be superior to the traditional vertical wellpoint systems, but exceptionally time and cost-effective as well.

During the early installation and development work, it soon became evident to HDSI's senior management that the application of the Horizontal Well extraction and recovery concept possessed additional advantages when applied to other water resource recovery, reuse and environmental enhancement endeavors, inclusive beach stabilization.

While continuing basic construction dewatering efforts, HDSI became convinced that the increasing value of water rights and declining sources of potable water made surficial recoveries even more important. That increased value is due in part to the natural hydrological cycle of water resources but more so by the need of states, cities and municipal authorities to access and use water in an environmentally responsible manner. Industrial and commercial enterprises have also created the need for site containment barriers, water cleanup and recharge and reuse.

In fact, waste water effluent discharge into natural surface water bodies is the subject of much state and federal legislation, regulation and policy, and the water reuse concept has been accepted - and in some cases, mandated - as a method of protecting and prolonging precious water resources.

To that end, Horizontal Wells have been installed as irrigation supply wells for agricultural operations like citrus groves and ferneries and even non-agricultural entities such as golf courses. HDSI has also used its system in cleanup efforts on contaminated sites - both for water and contaminate extraction - and for aquifer recharge using treated and/or processed water.

cont'd.

---

To date, HDSI has completed over 1,000 installations, utilizing nearly 300 miles of Horizontal Wells systems. This proven technology has been successfully used on both long and short term projects. Along the way, the company has developed many refinements in the system's capability and performance including better trenching production, extremely durable piping and filter materials, all adding to the overall performance of HDSI's highly skilled personnel. HDSI's acceptance in the marketplace is growing rapidly and serves to underscore the system's uniqueness as its major asset.

## How Does HDSI's Beach Preservation System Work?

---

If the water table at a beach face is higher than sea level, water tends to run out of the beach face, carrying sand with it, into the retreating waves.

However, if the water table at the beach face is artificially lowered below sea level, incoming waves drain into the beach face holding the sand in place, thus preserving the shoreline.

That is, each incoming wave is composed of a mass of water moving above some mean water level. The greater the mass of water in the incoming wave, the more solid material transport capacity is created. The hydrostatic pressure of these incoming waves breaks up the beach face by forcing apart its grains of sand and, when combined with the outflow of water from the beach face - and the turbulence of the breaking wave - suspends the sand in the retreating wave and results in the subsequent loss of beach material.

If the hydrostatic pressure within the beach face could be locally reduced, the inflow of water from waves into the beach face would result in an adhesion between the grains of sand on the beach. If the reduction in hydrostatic pressure is substantial enough, the beach face becomes resistant to material suspension, transport by wave action, and the result is a significant reduction in beach face erosion.

By removing water from the beach face, HDSI's proprietary system controls the hydrostatic pressure, providing the desired result. Its groundwater recovery and control system has been used extensively for years across a wide array of applications. Specialized patented equipment provides rapid, economic installation, while specialized operations and monitoring systems have been developed and are in use on the newest systems. The cost effective package of equipment, material and know-how can now be deployed in beach preservation.

Horizontal Wells can substantially prolong the life of beach fill and renourishment projects by keeping the material in place longer and can reduce recurring renourishment programs, costly to taxpayers, owners and others involved in beach preservation.

## Advantages of HDSI's Beach Preservation System

- Can be installed in a fraction of the time required for conventional sand drain dewatering systems.
- More cost effective than conventional systems.
- Dramatically less destructive than conventional systems and once completed, returns the beach front to its natural state.
- Environmentally friendly, even to sensitive turtle habitats.
- System components are long lived, even in hostile salt water environments.
- There are no hard structures to disrupt natural shore life.
- Depth of installation precludes storm damage.
- The system can be operated at variable rates, both automatically and manually. Once the shoreline is normalized, the system will function in a maintenance mode.
- Costly recurring beach renourishment cycles are minimized.



## Quotes on Benefits & Advantages of the System

"The benefits of this proprietary system are multi-fold:

- There are no physical above-ground or in-water impediments. This system, when installed and operating, offers no obstructions to walkers, strollers, swimmers or recreational use on the beach.
- It offers no impediments to any animals, fish, birds or organisms that live in the beach. The exposed features are virtually unnoticeable and are located on uplands designed to have no influence on any swimming organism. There are no structures to interfere with the swimming or feeding actions of fish or birds.
- It is invisible. The beauty, aesthetics and function of the beach remains the same.
- The system can be operated either manually or automatically. The function can be varied with natural changes in sediment transport rate, wave conditions, or seasonal requirements or can be adjusted to reduce the subsurface hydrostatic field on timing operational cycles.
- The system can be operated at variable rates. Thus, sands can be induced to collect and the system can be operated allowing the shoreline to normalize. Once the shoreline is normalized, the system will function in a maintenance mode.

Geo-Marine, Inc.  
Dr. Michael Stephen, Ph.D, P.G.

## Quotes on the Efficiency of the System

"Changes in ocean still-water level and beach ground water level are the most important variables influencing changes in foreshore sand volume." Coastal Zone Conference, 1989.

"This process can substantially prolong the residence time of beach fill material, extend project life and reduce the overall cost to the taxpayer." Dr. Michael Stephen, Ph.D., P.G., Geo-Marine, Inc.

Commenting on the actual installation of a beach face dewatering system, Dr. Robert G. Dean of the University of Florida stated: "The [beach] segment within the system...has experienced a gradual increase and has been relatively stable compared to the adjacent segments..."



# PROPOSED HORIZONTAL WELL BEACH PRESERVATION SYSTEM

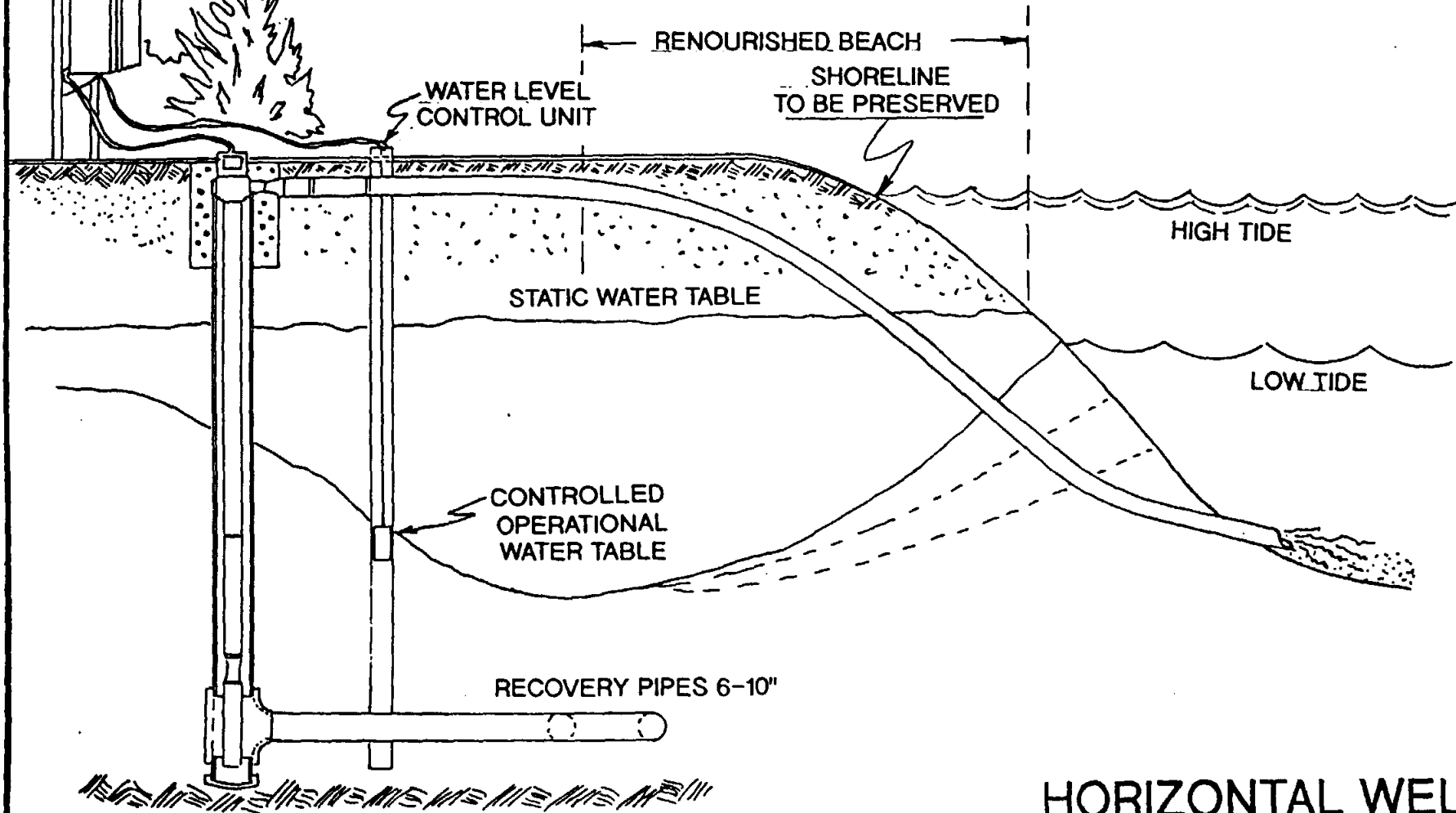

## HORIZONTAL WELLS

A DIVISION OF **H.D.S.I.**

P.O. BOX 150820 CAPE CORAL, FL 33915

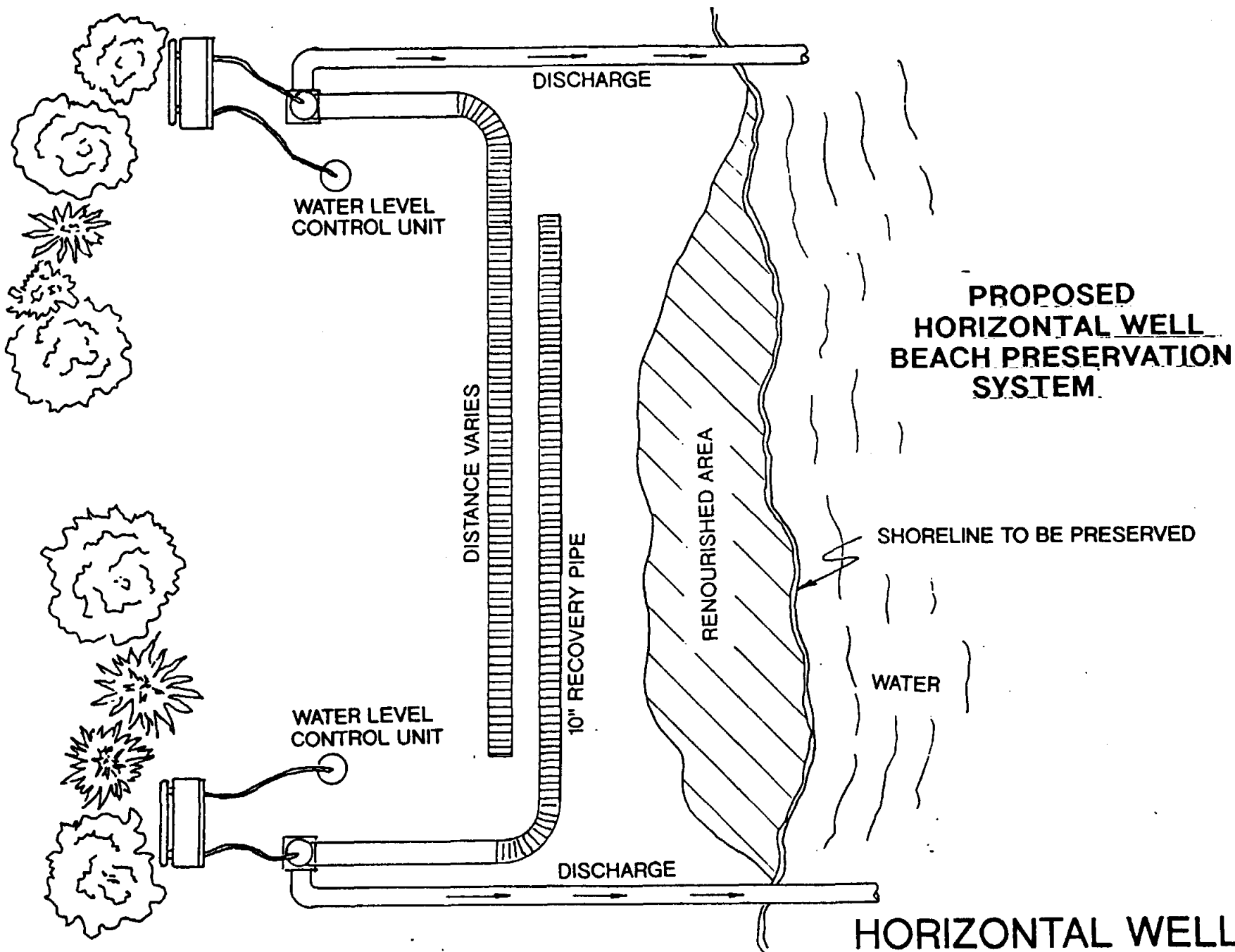

**PROPOSED  
HORIZONTAL WELL  
BEACH PRESERVATION  
SYSTEM**

**HORIZONTAL WELLS**

A DIVISION OF **H.D.S.I.**

PO BOX 150820 CAPE CORAL FL 33

**APPENDIX E**

**A VISCOUS DRAG SYSTEM**

**THE USE OF VISCOUS DRAG MATS TO  
PREVENT SHORELINE EROSION**

**Peter Alsop**  
**25 November, 1991**

## Introduction

The "Viscous Drag Mat" was designed to have a very high resistance to flow so that it could be applied to reduce wave and current energy. In addition, it had to be easily installed, cost effective, and reliable.

The "viscous drag" component of the mat is manufactured out of a specially formulated propylene polymer. This polymer offers both a specific gravity of .87, a significant improvement in polymer design, and a high tensile strength.

In order to achieve a very high density of buoyant tapes, a novel manufacturing process had to be developed. This allowed us to produce a mat that, when fully deployed on sea-bed, could achieve a tape density of up to one 1" x 5'3" tape per square inch. This would present a total wetted drag area of 3.8 million square inches uniformly distributed within 1109 cubic feet.

Under water, the side face of the mat presented to the water current entry yields and the water velocity is then progressively diminished as the tapes, through the body of the mat, exert a continuous drag force on the current. The mat, in its installed position, is designed to accommodate water currents from any direction. As the velocity of the current is reduced within the confines of the mat, carried sediment particles lose their flight mode and settle within the mat tapes, eventually building up into a highly cohesive reinforced soil bank.

## Anchoring System

Permanent retention of this high profile mass of buoyant tapes to the seabed is achieved through the use of a novel anchor. Each mat is anchored into the sea bed with 24 of these ground anchors. The anchors are driven in pairs to a depth of four feet. Each anchor in the pair has a minimum retention capability of two tons. Each mat, installed underwater in silty-sand, will have a minimum non-gravitational hold down of 48 tons.

Once installed, the mat will develop into a soil bank approximately five feet high with a base measuring 16.25 feet by 13 feet. This soil bank alone will weigh approximately 50 tons.

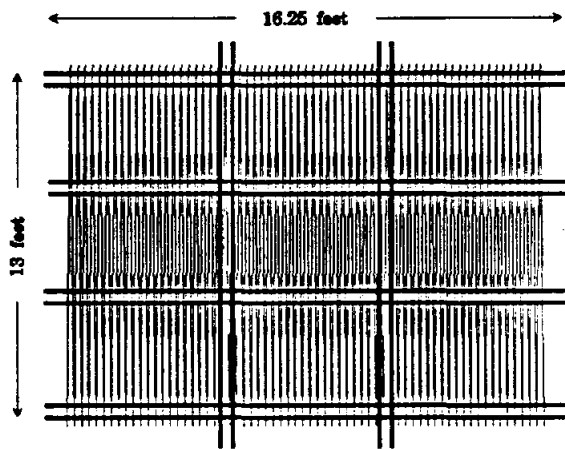

Bottom View of The Viscous Drag Mat Illustrating the Anchor Strapping Pattern. At the end of each strap pair, a pair of ground anchors is attached and driven down four feet.

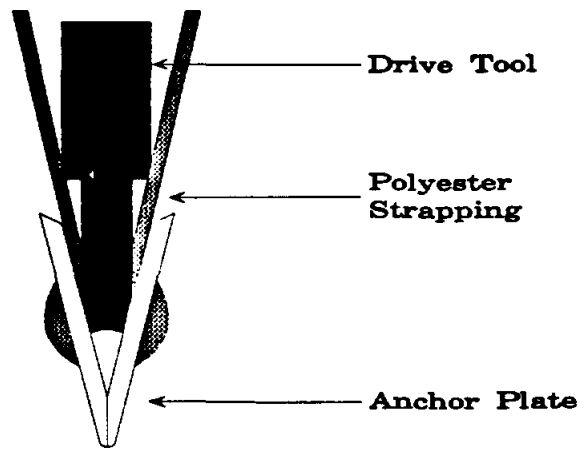

Anchor Pair Bent Into Driving Position. As tension is applied to the anchor pair, it will open up and split into two separate plates.

### Product Life

The mat has been designed for a long buried life. In meeting this requirement, the propylene polymer used for the buoyant tapes has been found to have little to no change in physical characteristics after twenty years burial.

## Installation

Installation in deep water is carried out by divers using a "dispenser" allowing a standard 5 meter (16.25') length mat to be installed on bottom within five minutes (10 meter/33.5' length mats can also be accommodated).

In shallow water an amphibious vehicle with a diver standby would be used, and runs of thirty meter (97.5') mats would be installed. Shorter runs could also be accommodated.

I would describe the reinforced soil bank generated by the mat as an "Engineering Tool" that could be applied in shore protection. Off shore breakwaters, shore connected breakwaters, jetties, and groins name but a few of the possible applications. In some cases the mat is used as a foundation, and others to form the entire structure.

## Advantages

I consider the following advantages as important considerations.

1. The system is environmentally acceptable. The European Fishermen recommend its use; it is inert and attracts fish through all stages of development including the finally formed bank. Whereas in my experience, the use of dumped stone can drive fish from their habitat for periods of up to two years.

2. The system is totally inert and will not contaminate the water. It does not adversely effect any marine life or vegetative growth.

3. The finally formed bank is not rigid in structural terms. It contour-follows the bottom profile and blends into the seabed, its shape fashioned by the current.

4. Soil particles settling within the mat are subject to vibration transmitted by the buoyant tapes agitated by the current. This results in an extremely high degree of soil compaction.

5. The mat is immediately effective on deployment.

6. The mat does not require any follow up maintenance, nor is it a sacrificial system requiring periodic nourishment.

7. It also has a significantly lower installation cost when compared to traditionally used systems.

## Breakwaters

In the course of carrying out a documentary study of coastal protection structures, I have established that the offshore breakwater, when correctly applied, displays the highest level of beach accretion. Failures recorded could be categorized under two headings, positional and structural.

In the case of position (location on bed), the results achieved were other than the primary engineering requirement. In other words, accretion and depletion of soil took place in the wrong zones. Not always a complete disaster, dredging and the introduction of additional diversionary structures were used as corrective mechanisms.

Structural failures such as breaching and collapses due to current, wave energy, and scour occurred frequently. Cost had obviously dictated design, which had a direct effect on the stability and life of the structures. Well designed structures, armored and monolithic in characteristic, survived and proved to be good for purpose in performance.

The argument not to use the offshore breakwater because it creates local accretion and causes depletion elsewhere as a result of diverting soil from long shore sediment transport should not in any way mitigate against its use. It is my opinion that only a small percentage of the long shore transported sediment would be retained locally, and the onshore wave-carried sediment would be the major contributor to the beach until a state of "soil build-up" equilibrium is attained.



Appendices

- Appendix A**      **Erosion Susceptibility Chart**
- Appendix B**      **Formation of an Underwater Reinforced Soil Bank**
- Appendix C**      **Viscous Drag Mats Used To Create an Underwater Berm**
- Appendix D**      **Photographs of The Viscous Drag Mat System**
- Appendix E**      **Viscous Dag Mat Installations**

# Erosion Susceptibility Chart

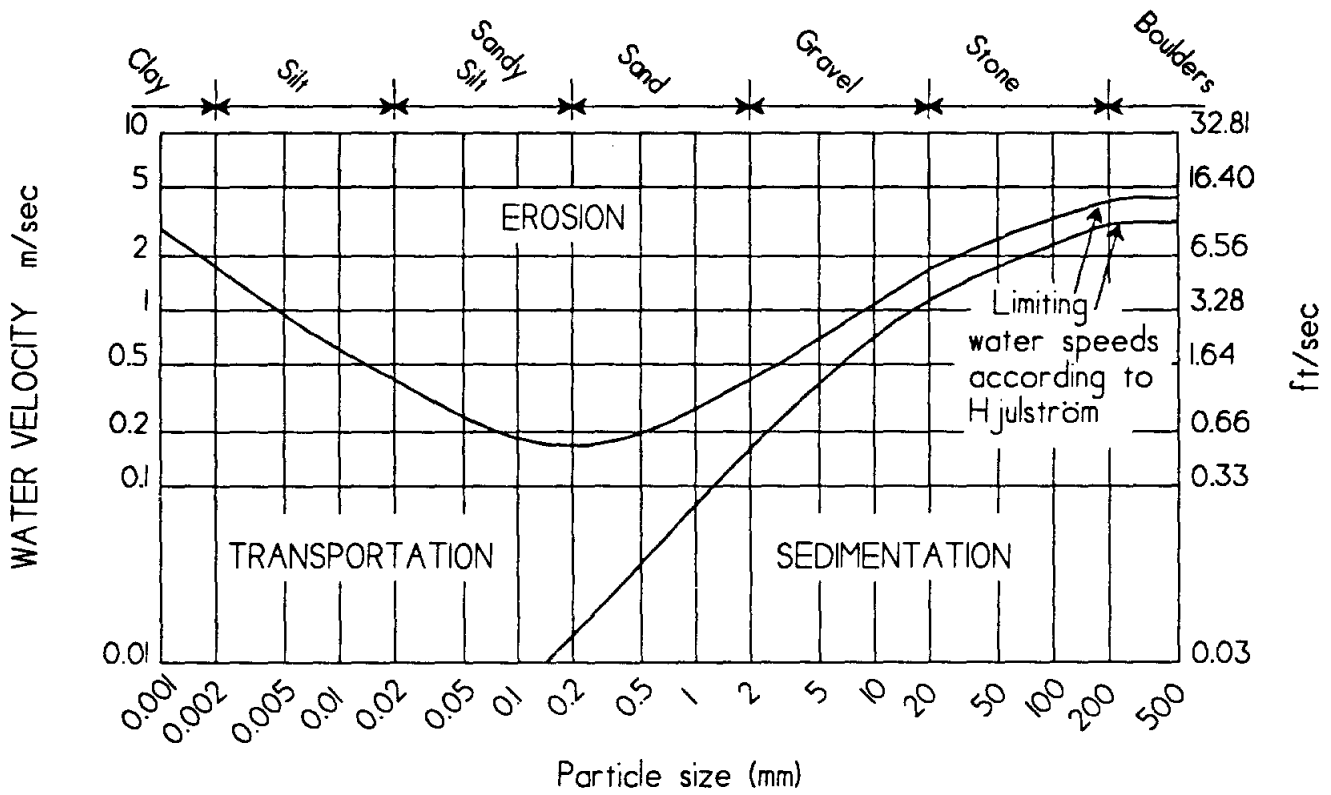

Erosion Susceptibility in Relation to Water Velocity and Particle Size

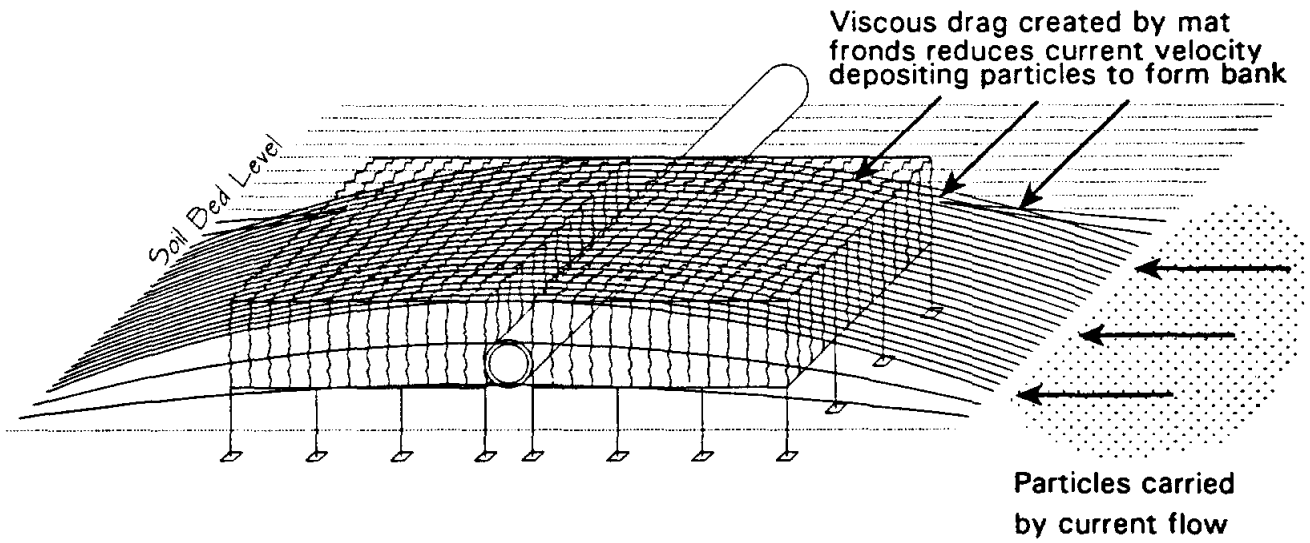
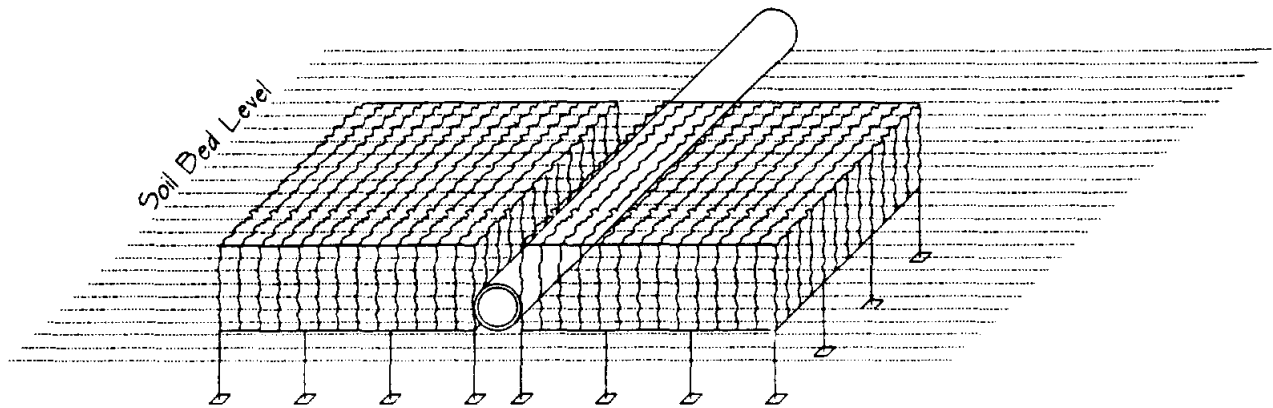

2 Erosion Control "Mats" Surrounding a Pipeline.  
Underwater Viscous Drag to Reinforced Soil Bank.

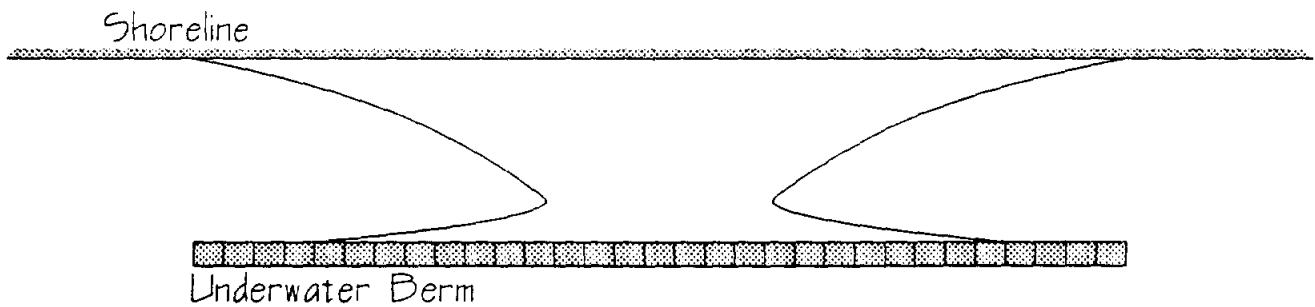
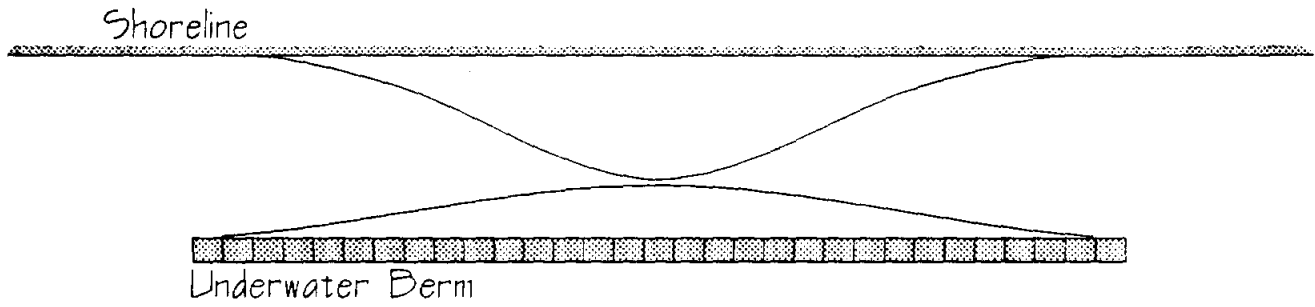
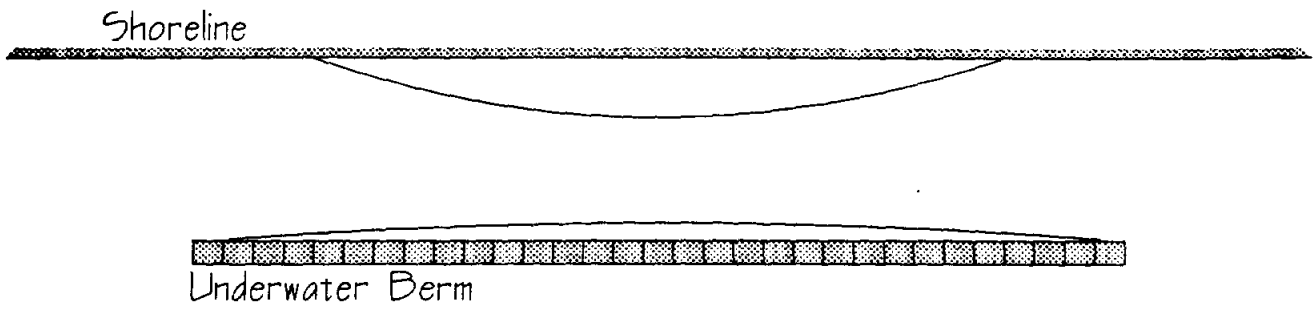

Stages in the Growth of a Tombolo Sand Bar.  
Plan View.

Erosion Control "Mats" Used to Create an Underwater Berm Inducing the "Tombolo" Effect.

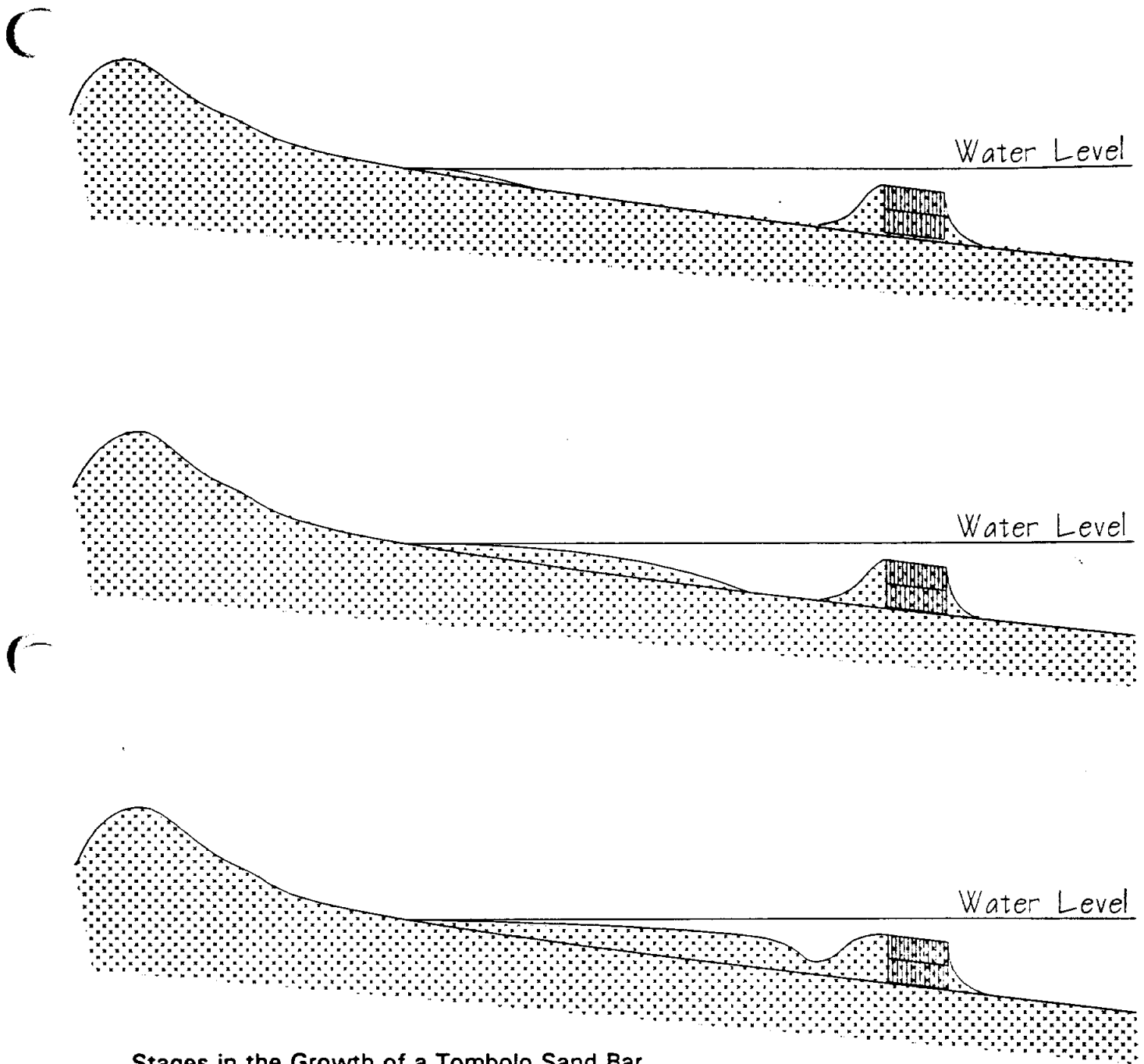

Stages in the Growth of a Tombolo Sand Bar.  
Side View.

Erosion Control "Mats" Used to Create an Underwater Berm Inducing the "Tombolo" Effect.

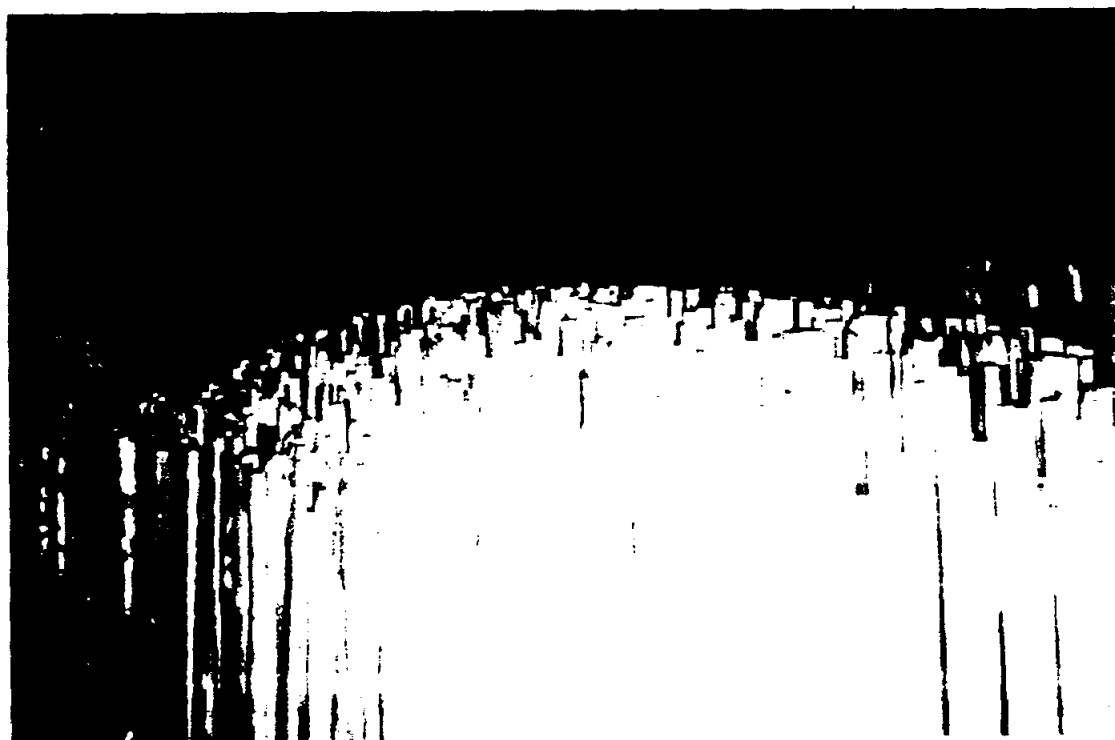

Viscous Drag Mat — Oblique View



Ground Anchors



Reinforced Soil Bank — 6 years.

Leman Field, Southern North Sea, Europe

Note: Abundance of Normal Marine Life



## Erosion Control Mat — Installations

Date	Client	Application / Location
May 87	Conoco	Jack-Up Rig Scour Correction - Valiant Field
Jul 87	Shell	Cable-pipeline Crossover Protection & Stabilization - Leman Field
Jul 87	Conoco	Pipeline Free Span Correction - Viking Field
Aug 87	Amoco	Jacket Scour Correction - Leman Field
Oct 87	Shell	Pipeline Free Span Correction
Dec 87	Shell	Jacket Scour Correction - Sean RD
Mar 88	Pennzoil, Holland	Jack-Up Rig Scour Correction - Dutch Sector
Apr 88	Shell	Jack-Up Rig Scour Correction - Leman Field
May 88	Pennzoil, Holland	Jack-Up Rig Scour Correction - Dutch Sector
May 88	Shell	Jack-Up Rig Scour Correction - Morecambe Bay
Jun 88	Amoco	Jacket Scour Correction - Leman Field
Jun 88	BP	Sub Sea Housing Stabilization - Ravenspurn Field
Jun 88	Conoco	Pipeline Scour Remedial Installations - 'V' Fields
Jun 88	BP	Spool Piece Free Span Correction - Ravenspurn Field
Jul 88	Scottish Electricity	Power Cable Stabilization Trials - Isle of Skye
Jul 88	BP	Jacket Scour Correction - Cleeton Field
Jul 88	Hamilton Bros.	Pipeline Free Span Correction - Esmond Field
Jul 88	BP	Jacket Scour Correction - Ravenspurn Field
Aug 88	British Nuclear Fuels	Pipeline Stabilization Trials - Sellafield
Aug 88	Hydrocarbons GB	Pipeline Free Span Correction - Morecambe Bay
Aug 88	Shell	Jack-Up Rig Stabilization - Leman Field
Sep 88	Hydrocarbons GB	Pipeline Stabilization - Morecambe Bay
Sep 88	Waveny District	Wave Energy Reduction - Corton Beach
Sep 88	Amoco	Pipeline Span Correction & Stabilization - Indefatigable / Leman Fields
Sep 88	Shell	Pipeline Stabilization - Leman Field
Sep 88	Phillips	Spool Piece Stabilization - Della Field
Oct 88	Mobil	Jacket Stabilization - Camelot Field
Oct 88	Phillips	Spool Piece Stabilization - Della Field
Nov 88	Shell	Jack-Up Rig Stabilization - Leman Field
Jan 89	Odeco, USA	Jack-Up Production Rig Stabilization - Gulf of Mexico
Feb 89	Mobil	Jack-Up Rig Stabilization - Camelot Field
Feb 89	Mobil	Pipeline Stabilization - Camelot Field
Mar 89	Shell	Jack-Up Stabilization - Sole Pit

## Erosion Control Mat — Installations

Date	Client	Application / Location
Apr 89	Shell	Jack-Up Rig Stabilization - Leman Field
Apr 89	Amoco	Pipeline Free Span Correction - Indefatigable Field
Apr 89	Arco	Wellhead Protection Frame Stabilization - Welland
May 89	Shell	Jack-Up Rig Stabilization - Leman Field
May 89	Conoco	S. Valiant Field Development / Viking BC/BD Platforms
Jun 89	Odeco, USA	Jack-Up Production Rig Stabilization - Gulf of Mexico
Jun 89	Amoco	Pipeline Free Span Correction - Indefatigable Field
Jul 89	Arco	Wellhead Protection Frame Stabilization - Thames Oscar Field
Jul 89	Amoco	Pipeline Free Span Correction - Indefatigable Field
Aug 89	Shell	Jack-Up Rig Stabilization - Leman Field
Aug 89	Marenco Engineering	Power Cable Scour Correction - Prince Edward Island, Canada
Sep 89	Hamilton Bros.	Subsea Valve Stabilization - Ravenspurn North Field
Sep 89	Clough-Stena	SALM Riser Stabilization - Timor Sea, Challis Field, West Australia
Sep 89	Oceaneering / Amoco	Jack-Up Rig Stabilization - Penrod 85 - Leman Field
Oct 89	2W / Hamilton Bros.	Scour Prevention - Cleeton / Ravenspurn Fields
Nov 89	Shell	Jack-Up Rig Stabilization - Rowan Gorilla
Dec 89	Shell	Production Riser Stabilization - Leman Field
Feb 90	Shell	Jack-Up Rig Stabilization - Cecil Provine
Apr 90	Stena / Shell	Scour Prevention - Sole Pit Field
Apr 90	Stena / Amoco	Pipeline Span Correction & Stabilization - Indefatigable & Leman Fields
Apr 90	Conoco	Jacket Stabilization - Viking BC Platform
May 90	Shell	Jack-Up Rig Stabilization - Galveston Key
Jun 90	Phillips	Jacket Stabilization & Correction - Hewett Field
Jun 90	Rockwater / Arco	Umbilical / Pipeline Tie-Ins Stabilization - Welland
Jul 90	Stena / Amoco	Pipeline Stabilization - Indefatigable Field
Aug 90	Shell	Pipeline Free Span Correction & Stabilization - Leman Field
Sep 90	Stena / Amoco	Pipeline Stabilization - Indefatigable Field
Sep 90	Shell	Riser Stabilization - Leman Field
Sep 90	Rockwater / Shell	Valve Frame Stabilization & Protection - Sean Field
Sep 90	Stena / Amoco	Pipeline Span Correction & Stabilization - Indefatigable & Leman Fields
Oct 90	Stena / Amoco	Pipeline Stabilization - Indefatigable Field
Nov 90	Stena / Amoco	Pipeline Stabilization - Indefatigable Field
Dec 90	Christiani Morrison	Dornoch Bridge Scour Correction & Stabilization

**APPENDIX F**  
**(under separate cover)**

**A REPORT ON**  
**PRELIMINARY DESIGNS OF IMPROVEMENTS**  
**AT ROLLOVER PASS AND VICINITY**  
**BOLIVAR PENINSULA, TEXAS**

**APPENDIX G**  
(under separate cover)

**SHORELINE EROSION SEMINAR**  
**QUANTITATIVE ANALYSIS AND DESIGN ASPECTS**  
**OF**  
**SHORELINE PROTECTION IN GALVESTON COUNTY, TEXAS**

APPENDIX F

A REPORT ON  
PRELIMINARY DESIGNS OF IMPROVEMENTS  
AT ROLLOVER PASS AND VICINITY  
BOLIVAR PENINSULA, TEXAS

This is a supplement to the final technical report on Shoreline Protection and Implementation Options for Galveston County, Texas, submitted to Dannenbaum Engineering Corporation, prepared by Dr. Y.H. Wang, College of Geosciences and Maritime Studies, Texas A&M University, Galveston, Texas 77553.

TWDB contract no. 90-483-771  
DEC subcontract no. RF-90-1142-6737

TEXAS A&M UNIVERSITY AT GALVESTON  
DEPARTMENT OF MARITIME SYSTEMS ENGINEERING  
P.O. BOX 1675, GALVESTON, TEXAS 77553



A technical report

on

PRELIMINARY DESIGNS OF IMPROVEMENTS AT ROLLOVER PASS AND VICINITY  
BOLIVAR PENINSULA, TEXAS

Prepared by

Dr. Y.H. Wang, P.E., Professor & Instructor,  
in cooperation with the students of the class of  
MASE 407 Design of Ocean Engineering Facilities  
Fall Semester, 1989

TEXAS A&M UNIVERSITY AT GALVESTON  
DEPARTMENT OF MARITIME SYSTEMS ENGINEERING  
P.O. BOX 1675, GALVESTON, TEXAS 77553



A technical report

on

PRELIMINARY DESIGNS OF IMPROVEMENTS AT ROLLOVER PASS AND VICINITY  
BOLIVAR PENINSULA, TEXAS

Prepared by

Dr. Y.H. Wang, P.E., Professor & Instructor,  
in cooperation with the students of the class of  
MASE 407 Design of Ocean Engineering Facilities

Beach Restoration Group

Mark I. Sales  
Laura L. Robinson

Sand By-passing Group

Michael S. Vickers  
William J. Hoffman

Coastal Structure Group

Nicholas G. Kyprios  
Miles F. Gathright

Environmental Impact Group

Michael E. Duncan  
Darrel K. Pelley  
Jung H. Yoon

December 1989

## ACKNOWLEDGEMENT

The design class acknowledges the participation and contribution of the citizens of Bolivar Peninsula who shared their problems, concerns and desire of improvements with the class. Sincere thanks are extended to Mr. Pat Hallisey, Executive Director of Galveston County Beach Park Board of Trustees and Mr. Eddie Barr, Galveston County Commissioner for their interests to make this design project a community-university-government joint affair for managing Texas coastline problems.

The class is also indebted to Dr. James Webb who talked to the class regarding the environmental impact study in general. Drs. Donald Harper and Herman Rudenberg were consulted on the benthic community effects and the creation of marshland.

Finally, members of the MASE 407 design class are grateful to Dr. Y.H. Wang, their Instructor, for his inspiration and initiation of this class project; his generous counsel and guidance throughout the course of this study are greatly appreciated.



## ABSTRACT

This design project, inspired and initiated by Dr. Y.H. Wang of the Maritime Systems Engineering (MASE) Department, Texas A&M University at Galveston, proposes some engineering alternatives to solve the excessive erosion in the vicinity of the man-made cut in Bolivar Peninsula called Rollover Fish Pass and to revitalize the now sediment choked Rollover Bay for the benefit of local residents on Bolivar Peninsula in particular and the well being of Texas coastline in general.

Rollover Fish Pass was originally constructed in the middle fifties in an effort to create a nursery area in the then unproductive waters of Galveston East Bay. This man-made cut is a flood dominated tidal inlet. These flood tides carry with them a large amount of littoral material (sand). A portion of this material is returned to the Gulf during ebb tides, but much remains. It is this facet of the Pass that has interrupted the natural flow of littoral material along Bolivar Peninsula. The net effect of this interruption has resulted in the severe erosion of the Gulf beaches, increased deposition of littoral material in Rollover Bay and the Gulf Intracoastal Waterway, and, the resulting steady decrease of saline water entering into Galveston East Bay.

The design class takes an integrated system approach. The comprehensive plan involves using the sands deposited in Rollover Bay in two ways. First, Rollover Bay would be dredged to a depth such that a marshland could be introduced. The sands thus recovered could then be used to restore and nourish the beaches where severe erosion threatens public and private property. Second, a pair of jetties to control the future movement of littoral material into the marshlands would be constructed. The plan then proposes using sand by-passing technology to minimize the interruption of littoral flow along the Bolivar Peninsula by pumping sediment around the Fish Pass and Jetties. Finally, an environmental assessment of all these proposed changes is made.

## TABLE OF CONTENTS

ACKNOWLEDGEMENT

ABSTRACT

EXECUTIVE SUMMARY AND PROJECT RECOMMENDATIONS

PART I Introduction

- I.1. Historical background & previous work on Rollover Pass
- I.2. Local Community Inputs
- I.3. Objective and scope of the present work

PART II Physical Environment

- II.1. Site description
- II.2. Nearshore environment
  - II.2.1. Water levels
  - II.2.2. Currents and circulation
  - II.2.3. Wave conditions
  - II.2.4. Weather fronts and storms

PART III Preliminary Designs of Improvements at Rollover Pass and Vicinity

Chapter 1. Beach restoration and nourishment plan  
Designers: Mark I. Sales & Laura L. Robinson

Abstract of beach restoration and nourishment

- 1.1. Introduction
- 1.2. physiology of the shoreline today
- 1.3. Sand source study
- 1.4. Determination of longshore characteristics
- 1.5. Determination of berm elevation, beach width & alignment
- 1.6. Determination of beach fill transition
- 1.7. Determination of feeder beach location
- 1.8. Re-establishment of duneline and dune stabilization
- 1.9. Cost-benefit analysis
- 1.10. Conclusions and Recommendations
- 1.11. References

**Appendixes:**

- I. Sand requirements
- II. Bolivar Peninsula Beach slope survey
- III. Rollover Bay sand analysis
- IV. Computation of overfill factor

**Chapter 2. Jetty design**

**Designers: Nicholas G. Kyrios & Miles F. Gathright**

**Abstract of jetty design**

- 2.1. Introduction
- 2.2. Hydraulic factors existing at Rollover pass
- 2.3. Preliminary jetty description
- 2.4. Cost-benefit analysis
- 2.5. Conclusions and recommendations
- 2.6. References

**Chapter 3. Sand by-pass design**

**Designer: Michael S. Vickers & William J. Hoffman**

**Abstract of sand by-pass design**

- 3.1. Introduction
- 3.2. Characteristics of the littoral regime near Rollover
- 3.3. Volume and frequency of sand by-pass operation
- 3.4. Preliminary design
- 3.5. Cost-benefit analysis
- 3.6. Selection between alternative designs
- 3.7. References

**Chapter 4. Environmental impact study**

**Designers: Michael E. Duncan, Darrel K. Pelley & Jung H. Yoon**

**Abstract of the environment impact study**

- 4.1. Introduction
- 4.2. Effects on water hydrology
- 4.3. Effects on ecological and biological systems
- 4.4. Legal considerations

**Appendix: Letter of transmittal**

EXECUTIVE SUMMARY AND PROJECT RECOMMENDATIONS

PART I INTRODUCTION

PART II PHYSICAL ENVIRONMENT

by

Dr. Y.H. Wang, P.E.

## EXECUTIVE SUMMARY AND PROJECT RECOMMENDATIONS

1. Assessment of current problems in the Rollover vicinity
  - 1.1 Land losses: Four rows of houses have been lost to the Gulf. The trend of land losses continues at approximately 15 feet per year by some investigators.
  - 1.2 Beaches: Approximately a 2-mile long stretch of coastline on both sides of the Rollover Pass has no beaches and dunes.
  - 1.3 Highway and Bridge: The state highway 87 and the bridge across the Rollover Pass are threatened by the continuous loss of land. The citizens feel that a major storm may wipe out the bridge and a segment of highway 87 near the Pass, thus, cut Bolivar Peninsula in two parts.
  - 1.4 The inlet channel: The steel sheet piles lining the inlet channel were badly corroded. Large waves and swells directly reached the inlet channel from the Gulf. Strong and swirl currents and eddies were observed in the Pass. Two drownings were reported in 1989.
  - 1.5 The Rollover Bay: The then 6-ft deep Rollover Bay is now choked up with sediments. Flushing of the Bay and salinity replenishment to the Bay water are impaired. During low tides, most parts of the Bay are dry and one can walk on it.
  - 1.6 The Intracoastal Waterway: The segment of Intracoastal Waterway north to the Rollover Bay is shoaling up by sediments from the Bay.

2. Improvements and solutions to current problems

A system approach to provide answers to current problems must be adopted. The comprehensive plan includes:

- 2.1 The dune-beach system in the vicinity of Rollover Pass will be restored to a size compatible to the natural coastline on Bolivar Peninsula for preventing further land losses and for providing recreational use by general public. The sediment materials for dune and beach restoration and nourishment will be derived from dredging the Rollover Bay.
- 2.2 The re-vitalization of the now smothered Rollover Bay will be done by removing the bay sediment for dune-beach restoration and simultaneously to create a marshland in Rollover Bay for substantial increase of biological productivity and for the improvement of water quality in the Rollover Bay through increased flushing.
- 2.3 The badly corroded steel piles lining the inlet channel walls should be replaced with corrosion resistant structure.
- 2.4 The future sediment movement to the Bay and the newly created marshland will be slowed/prevented by the construction of a pair jetties. These jetties would also improve the hydraulic conditions within the inlet channel.

2.5 The interruption of littoral flow of sediment along the Bolivar Peninsula by jetties will be remediated by a sand by-passing system which moves sediments around the Pass and Jetties to the down drift side.

3. Assesment of environmental impact

3.1 Volume exchange between Rollover Bay and Gulf will be increased due to dredging, consequently, the flushing time will also be increased by approximately 10 %.

3.2 Positive increase of salinity, although minute, would occur after implementation of the project.

3.3 The water quality of Rollover and Galveston East Bay will be improved because of the increasing volume exchange in the Rollover Bay and the decreasing sediment suspension after the completion of the project.

3.4 A temporary loss of benthic population would occur due to dredging, however, they are expected to re-establish their presence during or after the completion of the proposed plan. Shorebirds are to feed in the neighboring area temporarily during the construction period.

3.5 The bay bottom will be dredged to form contours and net works of small channels, thus allowing for salt water inundation. The creation of a marshland would make the area more biologically productive, and more species of biota would be able utilize the area.



#### 4. Cost-benefit consideration

##### 4.1 Cost of the project:

Dune-beach restoration and nourishment	\$3,430,000
Jetty construction	3,840,000
Sand by-passing, pump station system #	2,330,000
	-----
Total project costs	\$9,600,000

# (alternative sand by-passing scheme using dragline, the equipment rental fee is \$177,000/yr.)

##### 4.2 Benefits:

- \* Prevention of further land and property losses
- \* Avoiding relocation of State Highway 87 and the bridge across the Rollover Pass
- \* Improvement of water quality in the Rollover Bay
- \* Increased biota productivity due to creation of marshland
- \* Increasing of tourism
- \* Reducing dredging in the intracoastal waterway

An accurate account of these benefits in terms of dollar value is not available at this time due to narrow deadline for this study.

#### 5. Recommendations

5.1 It is recommended that the implementation of this proposed plan be carried out as soon as possible.

5.2 The badly corroded steel sheet piles along the inlet channel should be replaced with more permanent corrosion resistant structures.

- 5.3 Effort to quantify the benefits in terms of dollar value should be made immediately. The cost-benefit ratio is important for securing Federal and State funds.
- 5.4 More sand sample analyses to cover the depth and area of Rollover Bay must be done so that the source site of borrow material for beach restoration and nourishment can be finalized.
- 5.5 Creation of marshland is a relatively new technology. Joint effort between engineers, biologist and ecologist is called for. Design aspect of the creation of marshland should commence now.

## PART I Introduction

### I.1. Historical background and previous work on Rollover Pass

The Rollover Fish Pass is a man-made and artificially stabilized tidal inlet opened in 1954-1955 on the upper Texas coast approximately 19 miles northeast of the Galveston Bay entrance on Bolivar Peninsula, Texas. Problems with scouring in the Pass caused a closing for the installation of steel sheet piles along the sides of the Pass. Since the re-opening in 1959, beach loss in the area around the pass has averaged 14 to 16 feet per year according to the U.S. Army Corps of Engineers (USACOE). Erosion for the two sides of the pass have differed since the re-opening in 1959-1960, with the rate of shoreline loss on the southwest side of the Pass exceeding that of the northeast.

Numerous scientific studies on the inlet stability and the rate of littoral transport have been done in the past decades. A good re-count of these studies may be found in the paper by J.D. Bales and E.R. Holley which entitled Sand Transport In Texas Tidal Inlet published in the Journal of Waterway, Port, Coastal, and Ocean Engineering, Vol. 115, No.4, July, 1989 pp 427-443.

### I.2. Local Community Inputs

On September 13, 1989, the entire design class went to Bolivar Peninsula to attend a town meeting and to learn first hand regarding the problems, concerns and desires of improvements of citizens on Bolivar Peninsula. With the local community inputs the design group return to the class and started to formulate the objectives and tasks. On December 1, 1989, the Citizens on

Bolivar Peninsula were invited to Texas A&M University at Galveston in a presentation to hear the results that the design class has arrived at. Discussions and comments received during the presentation were incorporated into the final report.

### I.3. Objective and Scope of the Present Work

The objective of present work focuses on the utilization of existing data accumulated by various investigators in the past decades for the design of improvements. It is not another study on the Rollover Pass.

The scope of present work includes the following:

- \* Prevent further loss of beach front land and property
- \* Re-vitalize the Rollover Bay
- \* Maintain the integrity of the highway 87 near the Pass and the bridge across the Rollover Pass.
- \* The integrity and well being of the coastline along Bolivar Peninsula
- \* The improvement of the hydraulic conditions in the inlet channel, but leave out the inlet structural improvement which has already been scheduled for construction by the Texas Parks and Wildlife Department.

## PART II PHYSICAL ENVIRONMENT

### II.1. Site description

The man-made cut, artificially stabilized inlet channel which connects the Rollover Bay and Gulf of Mexico is called Rollover Pass. The Pass is located 19 mile northeast of Galveston Bay entrance and 38 miles southwest of Sabine Pass. The Rollover Pass is approximately 1500 feet long, 200 feet wide with variable depth ranging from 3 to 5 feet. The channel wall was lined with steel piles; concrete bulkhead were added later to the badly corroded steel pile sections seaward of the Rollover bridge. Steel piles were also driven across the channel immediately seaward of the Rollover bridge in the shape of a trapezoidal weir for the protection of the bridge foundation.

The Rollover Bay is located near the east end of Galveston East Bay and is separated from the Galveston East Bay by the Intracoastal Waterway and the dredge spoil areas. Free water exchanges between East Bay, Rollover Bay and the Introcoastal Waterway are observeable. During high tides, the water depth in the Rollover Bay is about 6 in. to 1 foot, while during low tides most bay area are exposed and dry. The Rollover Bay emcompass an area of 2.3 million square yards.

A two-mile long coastline on both sides of the Rollover Pass is severly eroded. The beach there is steep, short, shelly and with no sand on it. No duneline is in existance.

The steel piles lining the inlet channel are badly corroded. During a rough weather, big waves and swells reach the channel directly from the Gulf, as a result of this, slushing,

swirl currents and eddies in the channel are clearly visible. Two drownings were reported in 1989.

## II.2. Nearshore Environment

### II.2.1. Water levels

Astronomical tide along Bolivar Peninsula is about 2 feet on the average. Storm surge greater than 5 feet have occurred every 2 to 3 years.

### II.2.2. Coastal current and circulation

The magnitude of the longshore current is generally strong during Winter and Spring; while during summer months the current is directed toward the northeast due to predominated on-shore winds. The speed of the longshore current ranges from 0.67 ft/sec to 0.8 ft/sec.

### II.2.3. Wave conditions

Waves with heights exceeding 4.5 feet occur 1 to 3% of the time and wave height less than 2.0 feet occurs 25 to 50% of the time.

### II.2.4. Weather fronts and storms

There are about 15 to 20 polar fronts pass through the Rollover Pass region each year with wind speed up to 50 miles per hour. Fifteen hurricanes have made landfall within 50 miles of Rollover Pass during the last fifty years.

A good re-count of the nearshore environmental conditions were summarized by Bales and Holley in 1989.

PART III

PRELIMINARY DESIGNS OF IMPROVEMENTS  
AT ROLLOVER PASS AND VICINITY

by  
The Class of MASE 407

Beach Restoration Group

Mark I. Sales  
Laura L. Robinson

Sand By-passing Group

Michael S. Vickers  
William J. Hoffman

Coastal Structure Group

Nicholas G. Kyrios  
Miles F. Gathright

Environmental Impact Group

Michael E. Duncan  
Darrel K. Pelley  
Jung H. Yoon

CHAPTER 1 BEACH RESTORATION AND NOURISHMENT PLAN  
Designers: Mark I. Sales and Loura L. Robinson

TABLE OF CONTENTS

ABSTRACT

1.1	INTRODUCTION	
1.1.1	Project Description .....	1-2
1.1.2	Proposed Implementation.....	1-2
1.2	Physiology of the Shoreline Today	
1.2.1	Dune/berm/bar conditions .....	1-3
1.2.2	Littoral Transport characteristics .....	1-4
1.2.3	Extrapolation of the Foreshore Slope.....	1-7
1.3	Sand Source Study	
1.3.1	Regional Sediment Study .....	1-7
1.3.2	Evaluation and Selection of Borrow Material .....	1-8
1.4	Determination of Longshore characteristics .....	1-11
1.5	Determination of Berm Elevation, Beach Width & Alignment	
1.5.1	Present Beach Elevations and Widths .....	1-12
1.5.2	Renourished Beach profile Selection.....	1-13
1.6	Determination of Beach Fill Transition	
1.6.1	Shore Based Dredging of Rollover Bay.....	1-14
1.6.2	Pipeline Dredging of Rollover Bay .....	1-15
1.6.3	Drag Bucket Dredging from the Water .....	1-15
1.6.4	Placement of Material on the Eroded Beaches .....	1-16
1.7	Determination of Feeder Beach Location .....	1-16
1.8	Re-establishment of Duneline and Dune Stabilization .....	1-17
1.9	Cost-Benefit Analysis	
1.9.1	Benefits .....	1-17
1.9.2	Cost .....	1-18
1.9.3	Cost-Benefit .....	1-19
1.10	Conclusions and Recommendations	
1.10.1	The negative aspects .....	1-19
1.10.2	The Positive aspects .....	1-20
1.10.3	Recommendations .....	1-20
1.11	References .....	1-21
	Appendixes:	
	I- Sand Requirements .....	1-23
	II- Bolivar Peninsula Beach Slope Survey .....	1-27
	III- Rollover Bay Sand Analysis .....	1-39
	IV- Computation of Overfill Factor Ra .....	1-48



## ABSTRACT OF BEACH RESTORATION AND NOURISHMENT PLAN

The plan for restoring and nourishing the severely eroded beaches around the Rollover Fish Pass constitutes three sequential phases, namely, the understanding of the pysiology of the shoreline, the searching for sand sources, and the design of the restored beach-dune dimensions and elevation.

Past and present literature are surveyed, digested and compiled for the understanding of the physical environment. Sand samples are taken from the Rollover Bay and analyzed in the laboratory to evaluate their usability for beach restoration. Beach profiles are surveyed for the determination of restored beach-dune dimensions and elevation, and for the calculation of sand volume requirement. Finally, the cost and benefit are estimated and recommendations are presented.

## 1.1 Introduction

### 1.1.1 Project Description

The Scope of this chapter deals with our proposed renourishment of the Gulf shoreline, two miles to the north and two miles to the south of Rollover Fish Pass. Here the shore line has been severely eroded. The consensus in the literature, here see Bales and Holley (1986), who cite Morton (1975), and Seelig and Sorensen (1973) as claiming for the general trend, a loss of shoreline of five feet per year over the period between 1930 and 1984. We chose to use this figure as our bench mark because of it's general nature. We use this figure because this figure is the most believable for loss as a general trend and not simply over an arbitrary observation period.

In using this figure we seem to ignore the major changes in shoreline as a result of catastrophic storms and tides. Since storm losses cannot be predicted except as general trends, we felt this was the only manageable way to arrive at a useable figure. We also believe that most of the catastrophic storm loss of beach results in offshore movement of littoral material, see COE Shore Protection Manual (1984). Some of the catastrophic shoreline loss can be prevented through care of vegetation and dune integrity.

### 1.1.2 Proposed Implementation

We propose to reclaim beach lost to material moved into Rollover Bay since the Rollover Fish Pass was cut in 1958. In order to do this we require on the order of one million cubic yards of sand (more exactly 830,000 cubic yards, see Appendix I).

Since Rollover Bay has absorbed some of the sand eroded from the Gulf Beaches, our plan of choice involves the use of the material that has been deposited there over the years. This material is, due to the sorting effect of the sand transport action, different in composition to the material currently on the Gulf beaches. This difference is due to the sorting effect of the hydraulic flow action that carried the sand into Rollover Bay. This sorting leaves the larger sand grains and only takes those grains that the fluid flow can carry.

It is for that reason that our plan includes as part of the calculations, use of an overfill factor. Overfill factor is the multiplier for the material put on the beach to compensate for long term loss of beach material due to the beach energy absorption characteristics.

The final part of our plan will propose some methods to keep the beach and duneline thus created from being piled up on the Galveston Bay North Jetty or into Rollover Bay.

## 1.2 Physiology of the Shoreline today

### 1.2.1 Dune/Berm/Bar conditions

Our Survey (see Appendix II) indicated that the beaches between the Galveston Bay North Jetty and the Crystal Beach water tank were accretionary. The remainder of the beaches that we surveyed on Bolivar Peninsula were subject to erosion to one extent or another.

The erosion beaches varied significantly as to width. The erosion beaches to the north of the Fish Pass were wider than those

to the south. Our hypothesis is that during the period of the survey, early November, what we were seeing was the result of the south western longshore transport of littoral material. The beach widths to the South West of the Pass were filling the fluid's sand-budget deficit caused by the trapping of sediment within the Rollover Bay/GICWW/Galveston East Bay system. The difference in beach widths between north of the Pass and south of the Pass is about eighty feet in width.

In addition to the errors induced by a one-time survey, ideally we should have surveyed the beaches at regular periods over the course of at least a year, we believe that the recent passage of Hurricane Gerry in October may have significantly changed the normal beach profiles. This could be deceptive because storm waves have the effect of carrying sand offshore. Gerry could have widened the beaches that we surveyed. According to the residents of Gilchrist that we met at the town meeting in October, the near direct hit from Hurricane Chantal eroded much beach during the summer of 1989. We feel that while the residents and visitors are entitled to easy access to the beaches, the current practice of removing the dunes at the ends of local streets to provide vehicular access to the water contributes to storm erosion. In addition, the practice of driving vehicles on the beaches near the berm and dune should be discouraged in order to promote vegetation growth.

### 1.2.2 Littoral Transport Characteristics

The littoral transport characteristics of the Gulf shore of

Bolivar Peninsula are not straight forward. The literature on the area seems often to be contradictory. Bales and Holley (1986) point out that short term trends are variable. In fact the climatological data indicates that currents in the winter months are weak with no real evidence as to direction. For the remainder of the year data is more conclusive:

June, July and August....strong current to Northeast.

March, April, May, September, October and November...strong to the southwest.

These southwestern currents are dominant only 56 percent of the year, on average. We take this to mean that with varying current direction the suspended littoral material entering Rollover Pass can come from either side of the pass. The net effect of this is that erosion rates are higher on the southwestern side of the pass.

Figures vary widely as to the net longshore transport of littoral material. The estimates of littoral transport are as follows:

Longshore Transport

Net annual longshore transport near ROP has been calculated as 96,000 cu yd (74,00 cu m ; USACOE 1984a), no more than 75,000 cu yd (58,000 cu m; Prather and Sorensen 1972), 58,000 cu yd (45,000 cu m; Mason 1981), and 54,000 cu yd (41,000 cu m; Hall 1976). The estimates of Mason (1981) and Hall (1976) apparently include only wave-induced transport; those of the USACOE 1984a and Prather and Sorensen (1972) are both for wave- and wind-current induced transport. The USACOE (1984a) estimated the net wave-

induced transport to be about 57,000 cu yd (44,000 cu m). Thus, net annual longshore transport near ROP is probably between about 75,000 cu yds (58,000 cu m) and 115,000 cu yd (88,000 cu m), if it assumed that the independent estimates of wave-induced (58,000 cu yd) and wind-induced (57,000 cu yds) transport can be added. All of the studies concluded that the net littoral drift was to the southwest.

According to the USACOE (1984b), tidal inlets can be assumed to trap between 5 and 25% of the net annual longshore transport. Based on that hypothesis, then, the net sand-transport rate through ROP would be between about 3,800 cu yd/yr (2,800 cu m/yr) and about 29,000 cu yd/yr (22,000 cu m/yr), assuming a net annual longshore transport of between 75,000 cu yd (58,000 cu m) and 115,000 cu yd (88,000 cu m). Because ROP is a relatively small inlet, it might be reasonable to presume that the ROP trapping rate would be in the lower portion of the reported 5 to 25% range. (1)

Due to the flood tide-induced transport we came to believe that since at the time of construction of the pass the average depth of water in Rollover Bay was 6 ft. Now of course the water depth is completely changed as we have sand bars, some of which have elevations in excess of a foot at mean lower high tide. This means to us that despite sea-level increase we have a net deposition in excess of 3 million cu yd of sand over the thirty year period. This directly contradicts Bales and Holley (1986) who use Fisher et al. (1972) to indicate that Rollover Bay is depositonally stable. Our rough estimate is that on the order of 118,200 cu yd are deposited per year.

### 1.2.3 Extrapolation of the Foreshore Slope

Because of the time constraints imposed upon us by the University's semester, we were unable to physically survey much of the area. One of the areas we were unable to survey was the off-shore Gulf surf zone out to the offshore bars. It would have been nice to be able to say where the bars were located; instead we had to extrapolate from the NOAA nautical charts 11332 and 11326. From these sources we obtained rough distances from the MLLW (Mean Lower Low Waterline) to the six foot contour on the chart. This was perhaps enough for a preliminary design but any final plan should include a complete survey of the off-shore waters in the area and involve several surveys over time to indicate seasonal changes due to changes in wave-induced sand bar movement.

We did note as part of our survey, that on the day of our survey that there were three areas where the waves broke. The seas on the day of our survey were running about three feet. The nearest breaking zone was 30 ft from the water's edge. We took this to mean that the bar nearest to the beach was about 30 ft off-shore.

It is important to re-iterate that the slope of the foreshore, also known as the active zone, will change with the seasons. This is the result of prevailing wave-energy and direction.

## 1.3 Sand Source Study

### 1.3.1 Regional Sediment Study

As part of our over-all design, members of the MASE-407 class

collected sand samples from three sites in Rollover Bay and from the severe erosion beach on the Gulf. This sampling was carried out by Mike Duncan and Jung Yoon.

Duncan and Yoon noted that as they collected the samples, that the sands' size diminished as a function of the depth they were taking them from. This observation was borne out when the design group's analysis of the sand samples was finished.

Our hypothesis from this finding is that the sands in Rollover Bay have been deposited (we only able to sample to a depth of three feet) with the sands graded from the finer sands on the bottom to the larger sands on the surface. We believe to be in line with the historical evidence of the hydraulic deposition of Gulf beach sands as we have discussed before. The results of the sand analysis are discussed in greater detail in the evaluation and selection of borrow material and Appendix III.

The composition of the Gulf beaches are similarly graded. The accretionary beaches towards the Galveston Bay North Jetty consist of relatively fine beach sands. The beach materials evident on the surface tend to get larger as one approaches Rollover Fish Pass from the west. In fact when the beach visibly steepens, about two miles south west of the pass, we noticed the presence of shells and shell fragments in the berm (the portion of the beach between the foreshore and the duneline). The shell may have been laid there deliberately to retard erosion, for which it is well suited; which is evident by it's continued presence on the beach over time.

### 1.3.2 Evaluation and Selection of Borrow Material



Borrow sites are the sites from which beach renourishment materials, sand, can be obtained. The selection of these sites is complicated because the sites have to be considered for various characteristics. The most important of these characteristics are the suitability of the sand and the amount available. One must also consider the effects of removing the desired amount of sand on the sand budget and on the resident organisms. In addition the site must be evaluated in terms of the site's ability to renew itself.

We approached the selection of a borrow site with a number of group divined criteria. First due to time constraints, we could only consider in detail material that we could physically examine. This approach is unacceptable for a larger-scale project as we were unable to directly examine any off-shore material. Secondly, when we initially considered the project we had in mind fixed fiscal constraints as a primary facet of the design.

Later, in order to do a more complete study we had to come up with a complete plan; and then try to minimize the costs. We had two areas that we considered from the start. Our parameters ruled out consideration of the sites that the USACOE Galveston District selected in their Galveston County Shore Erosion Study; Feasibility Report and Environmental Impact Study for Beach Erosion Control (1985b). The areas that COE selected were Offshore Bolivar Peninsula and Offshore High Island; approximately 2.5 nautical miles south-southwest offshore of Crystal Beach and 3 nautical miles southwest offshore of High island respectively.

We approached the renourishment of the severely eroded beaches

by first determining what we wanted to accomplish:

1. Provide a berm of at least 100 ft wide.
2. Establish a duneline at least 7 ft high continuously along the eroded 4 mile stretch of beach.

Using the severely eroded beach profile we estimated that we would require 820,300 cu yd of sand to fulfill the task. This figure does not include the beach overfill. Overfill describes an empirical multiple of the volume of sand placed upon a renourished beach in order to ensure that enough grains of a size suitable for retention are provided. The overfill factor  $R_a$  is dependent on the choice of borrow material.

The sites we considered were in Rollover Bay and offshore Bolivar Peninsula northeast of the Galveston Bay North Jetty. We quickly eliminated consideration of the second site due to our inability to judge the amount of material available. Initially, we had considered the site feasible in terms of a shore-based dredging rig. We were unable to judge an accurate refilling rate for an area on the site, especially considering possible changes in sediment transport as a result of construction of Jetties at Rollover Pass. Other negative factors are the difficulties in accessing enough sand from the beach. This left us only the option of an offshore based dredging outfit suitable for shallow water work. This and the Galveston District COE were similar enough for us to use their data even though their site is described as lying in 20 ft of water because an offshore dredging outfit would probably have to work from that depth in towards the beach.

The second site, that of the material inside Rollover Bay,

became more attractive the more we looked at it. For our uses, this material, we are certain, was deposited directly from sand taken from the severely eroded beaches that we wish to renourish. The benefits of the Rollover Bay site are as follows:

1. Close proximity to the eroded beaches; no two points under consideration are more than three and a half miles apart.
2. Removal of some of these sands can only improve the habitability of Rollover Bay and flushing of East Bay.
3. Dredging of this area will make possible the introduction of marshland grasses and the establishment of a wetland area.

The last two arguments, being of an environmentally enlightened motivation have the added benefit of enabling us to make a strong case for this site being chosen.

Our analysis of these sands and the associated computations are in Appendix III. The grain size distribution data are used in Appendix IV to compute the overfill factor from the method described in James (1975) and USACOE (1984b) the Shore Protection Manual. The results of all these calculations was an overfill factor (Ra) of 1.4.

We used Ra as a multiple of the material we plan to place in the foreshore (active zone). In round numbers this meant that we have to provide 188,000 cu yd of sand (60,000 cu yd extra over that required) in order to allow the unsuitable material to be carried away by the natural processes.

#### 1.4 Determination of Longshore Characteristics

The longshore characteristics of Bolivar Peninsula are

governed by the littoral barrier of the Sabine Pass jetties to the northeast and the partial littoral barrier of the Galveston Bay jetties to the southwest.

The addition of our jetties will alter the current characteristics of the longshore flow patterns. The jetties have been designed to block 90% of the longshore littoral flow. Some loss offshore is to be expected. The disruption caused by the jetties can not be definitively quantified prior to their construction.

Our plan allows some flexibility in this regard with our drag bucket method of sand bypass. The feeder beach can be moved easily to maximize benefit on a year to year basis.

## 1.5 Determination of Berm Elevation, Beach Width and Alignment

### 1.5.1 Present Beach Elevations and Widths

Our determination of berm elevations and beach widths was based on our survey of the Bolivar Peninsula beaches (see Appendix II). The results that we obtained were as follows:

<u>Profile</u>	<u>Berm Elev (ft)</u>	<u>Beach Width (ft)</u>	<u>Dune Elev (ft)</u>
1	5	230	11.5
2	2	208	9.3
3	3.2	170	8.8
4	3	160	7.3*
5	3	120	6*
6	4	80	6*
7	2.8	120	7*
8	2	175	5*
9	1.5	120	5.5

\*Highest Elevation- Dune missing or incorporated into berm.

The beach alignment along the area was consistent throughout with the exception of those areas adjacent to the fish pass. The hard structures at the fish pass, the steel and concrete bulkheads, have created discontinuities in the alignment of the beach.

#### 1.5.2 Renourished Beach Profile

The new beach profile that we would use to renourish the eroded beaches is a copy of the profile of the neutral beach that we found on Bolivar Peninsula. We believe this profile to be the most resistant to offshore littoral movement. The natural profile, as shown in Appendix II, was found between the accretion beaches and the erosional beaches. The existence of this beach results from normal wave action so we are confident that, with seasonal change, the profile will accommodate different water energy states.

We calculated the cross-sectional area of the eroded profiles and overlaid them with our design beach (the neutral profile) and

found that the change on either side of Rollover Fish Pass to be similar(see also Appendix I). To the southwest, we plan to move the water line seaward one hundred and fifty feet. In addition we plan to include a dune line eight feet high and twenty feet wide. This over the two mile stretch will require 313,000 cu yds of fill.

To the northeast, where the beaches are wider but lower, we would use the same dune line and elevation but will move the waterline seaward only seventy five feet. The sand required for the two mile stretch is 321,000 cu yds.

Both renourished profiles will feature the new dune line twenty feet seaward of the current dune/erosionary cliff face. The new berm width can be compared to that proposed by the COE. The COE plan proposes a beach width of two hundred feet for a one mile stretch. What they really are proposing is a feeder beach, being supplied with sand from offshore. Thus there are no provisions for dune formation.

## 1.6 Determination of Beach Fill Transition

### 1.6.1 Shore Based Dredging of Rollover Bay

We considered this method of access to the sand bars in Rollover Bay. The method we initially considered would be to use earth moving equipment to throw up temporary levees during lower low tides. With an area thus protected, construction equipment could simply proceed to directly load trucks with the sand. The trucks could then proceed to the offloading point(s).

With this method, we supposed that the sand movement could be done in short order. Unfortunately since we were unable to find

any similar operations in the literature, or data on how long our temporary levees would hold, we were unable to proceed further with this theory.

Other proven methods of shore based dredging included building earthen vehicular ramps out into the bay and simple drag bucket operations from the shore. Neither method would be feasible for this task.

#### 1.6.2 Pipeline Dredging of Rollover Bay

The use of either rotary head dredges or pump/jet dredging outfits in Rollover Bay was considered by the group. While this method is routinely used in many areas it was the belief of the group that either method would suspend too much of the lighter littoral material. The suspension of these materials in an environmentally sensitive nursery area would not be acceptable.

#### 1.6.3 Drag Bucket Dredging from the Water

This was the method that we finally chose. It has the following advantages over the other methods:

1. This would access the larger grained sediments first.
2. Since the Dredge would be mounted on a barge(s), this would allow selection of a shallow draft hull for complete access to all areas of the Bay. Additionally, the barge can be moved to offload the material with the same bucket, giving us a cost saving.
3. The barge can be offloaded to a number of shoreside storage dumps, this will allow some drying to occur. The dry material can then be handled more efficiently.

#### 1.6.4 Placement of Material on the Eroded Beaches

There are two possible methods of sand placement on the eroded beaches. The first is by using trucks to haul the dried material from the dumps to the renourishment sites.

And the second is pumping the material from the barge through the fish pass and directly onto the eroded beaches through a pipeline.

Both methods would require working the sand with earth moving equipment on the renourished beach to conform to our ideal beach profile.

#### 1.7 Determination of Feeder Beach Location

Feeder Beaches are selected sites where sands are placed so as to fill the waters' sediment budget. The sands thus placed are sacrificial in nature and the site must also be considered in terms of vehicular access (as in our sand bypass plan) for periodic renewal.

The location of feeder beaches depends on the planned size and shape of the feeder beach. The subject is covered in more detail in the sand bypass chapter of this paper.

The beach survey in Appendix II was used to confirm that, due to net annual longshore littoral processes, the beaches to the south east of the fish pass are the most eroded. Thus the most advantageous location of any feeder beach would be south west of the fish pass and updrift of the most severely eroded beaches.

The presence of any new hard structures must also be



considered in selection of a feeder beach site. The feeder beach should be located at least 200 yards from a hard structure (this depends on the length of the hard structure from the beach) if we are to get the material into the littoral flow field.

### 1.8 Re-Establishment of Duneline and Dune Stabilization

When the construction equipment completes a section of the duneline, we envision the immediate planting of vegetation to stabilize the dune.

The existing native plants should be encouraged to overrun the new dunes. In the initial planting, panic beach grasses, (*Panicum amarum*), and sea oats, (*Uniola paniculata*) are recommended for rapid growth and durability, respectively.

These plants will act as a virtual sand fence; at once holding the sand in place and trapping moving sand, thus encouraging dune growth.

These plants can be purchased from nurseries but are most often transplanted from in situ nurseries. Thus as soon as funds become available for this project, an effort should be made to establish such a nursery in the project area rapidly.

### 1.9 Cost-Benefit Analysis

#### 1.9.1 Benefits

It is extremely difficult to put a price tag on recreation areas but it is even more difficult to price improvements in marine populations and the water quality benefits. A partial list of benefits with estimated dollar valued benefits follows:

1. Property savings @ 5ft/ yr...2.43 acres saved per year. So over just a ten year period we are saving 24.25 acres. If we consider a median price of \$40,000 per acre we are gaining a benefit of \$970,000.

2. In California, recently, a private company paid \$10,000,000 to maintain a wetland half as large as that we can introduce in Rollover Bay.

3. As there are no large resorts on Bolivar Peninsula we cannot find a figure for increased revenue for tourists using the beach. We can, however, claim a value increase for property on the beachfront in the erosion areas of on the order of 10%. A conservative value for this increase is \$ 2,000,000 total.

#### 1.9.2 Costs

We estimate a construction time of eight months, granted that this is optimistic. We do believe the dredging to take at least that long, however, the placement of fill on the beach will take only half as long, so we take that as an average.

The following is a list of costs:

1. Dredge and trucks (per cu yd of fill moved)	\$ 2,250,000
2. Earthmoving Equipment	\$ 80,000
3. Barge and Handling Vessel	\$ 72,000
4. Insurance and Overhead	\$ 360,300
5. Contingencies and Surveys	\$ 600,000
6. Vegetation	\$ <u>70,000</u>
Total	\$ 3,432,300

### 1.9.3 Cost-Benefit

While this is simplistic, we find that the benefits out-weigh the costs by almost \$ 10 million. Some of the benefits must be applied to other areas of this plan.

## 1.10 Conclusions and Recommendations

### 1.10.1 The Negative Aspects

As you have read in the previous sections, and in the quote from Bales and Holley (1986), there are some discrepancies in the data on the flow through the fish pass. This confusion is the result of the discrepancies in approaching estimates of flow and littoral movement in the historical data. Mason (1981) describes two instances of historical disorder in the data. The first being where tide measurements made between 1887 and 1890 were lost. The second case concerns tidal measurement between November 1956 and February 1957 with malfunctioning gages.

Though these problems seem minor given the time frame, the literature indicates that much of the other work done in this area is a sketchy patchwork of short term study. Historically, others have studied the area, as we have, within a narrow deadline and this must make their, and our, conclusions suspect.

Since the literature and our work are serious attempts to explain the previous processes, they should not be disregarded. What is obvious is the need for more study. We believe that further delay is not warranted but that work should commence soon, whether our plan or another. With any modifications or structures changes will result, this will invalidate some, or all, previous

work; so as work takes place, constant monitoring will be a necessity. This monitoring should be such that detrimental processes that arise can be nipped in the bud, by modifying the plan used.

#### 1.10.2 The Positive Aspects

We are convinced that implementation of beach nourishment, the new, continuous duneline and widened berm, is overdue. While there may be those who have reservations on the financial expenditure, what we see is a good plan, partially completed at the outset, whose completion has been overlong delayed.

The on-going processes of erosion are the result of three major influences:

1. The damming of rivers
2. Jettied ship channels and associated littoral damming
3. The cutting of a fish pass that allowed a loss in the longshore sediment budget

We can not call for change in the first two but, with this plan in toto, we can reduce the influence of the third.

#### 1.10.3 Recommendations

We recommend that further study and construction begin as soon as possible. Delay will only worsen the situation. In the short term, property will be lost and marine populations in Texas coastal waters will continue to decline. While we can put a short term price tag on the first, delay for the second could result in declines from which marine populations may never fully recover.

## 1.11 References

### 1.11.1 Primary Sources

1. (1986) Bales, J.D. and Holley, E.R. Sand Transport in Texas Tidal Inlet
2. (1984a) U.S. Army Corps of Engineers Galveston District Galveston County Shore Erosion Study, Feasibility Report on Beach Erosion Control; Volume 2; Gulf Shoreline Study Site Report
3. (1984b) U.S. Army Corps of Engineers Fort Belvoir Shore Protection Manual
4. (1958) U.S. Army Corps of Engineers Galveston District Report on Beach Erosion Control Cooperative Study of the Gulf shore of Bolivar Peninsula, Texas (Erosion at Rollover Fish Pass)
5. (1981) Mason, C. Hydraulics and Stability of Five Texas Inlets
6. (1975) Davis, J.H.Jr. Stabilization of Beaches and Dunes by Vegetation in Florida
7. (1989a) Gilchrist Town Meeting September 13
8. (1989b) MASE-407 Sand Sampling
9. (1989c) MASE-407 Shore Profile Survey

### 1.11.2 Secondary Sources

1. (1981) U.S. Army Corps of Engineers Texas Shore Protection
2. (1976) Richardson, T.W. Beach Nourishment Techniques
3. (1973) Seelig, W.N. and Sorensen, R.M. Numerical Model Investigation of Selected Tidal Inlet-bay System
4. (1975) Morton, R.A. Shoreline changes between Sabine Pass

and Bolivar Roads: an Analysis of Historical changes of the Texas  
Gulf shoreline

**APPENDIX I**  
**Sand Requirements**

The following table lists the sands available and the sands required, according to our estimates, for the renourishment of the four miles of gulf beaches on either side of the Rollover Fish Pass.

Cross-sectional Areas:

Northeast of Fish Pass.....	91.1 sq yds
Southwest of Fish Pass.....	88.9 sq yds

Sand for new cross-sectional areas:

Northeast fill.....	320,000 cu yds
Southwest fill.....	312,900 cu yds
Active zone overfill (Total).....	188,000 cu yds
*****	
Total.....	820,900 cu yds
*****	

Also included are sketches of the proposed new beach profiles laid over the existing profiles. Also included are before and after plan drawings of Rollover Bay that show the East Bay access channel.

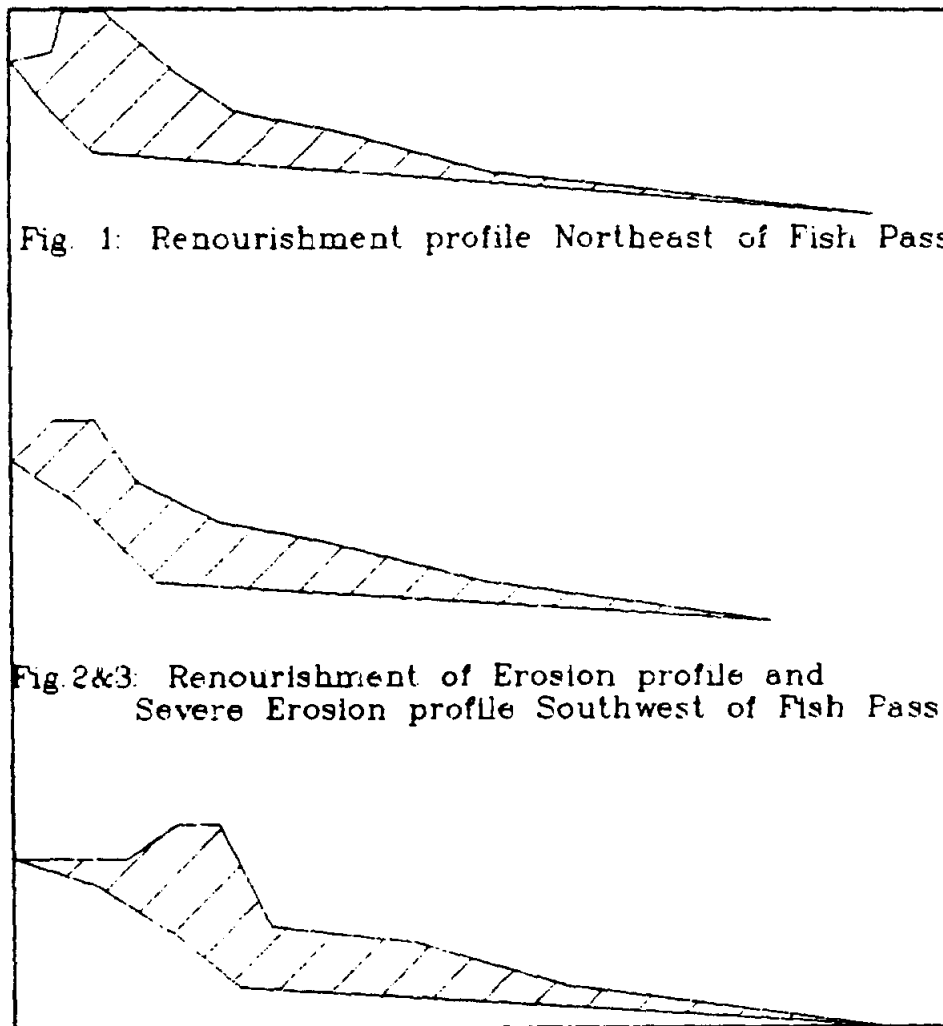



The following is a table showing our determination of the sands our plan uses to renourish the Gulf beaches and fulfill the environment features of the wetland and saline water access to Galveston East Bay:

Areas:

Rollover Bay.....2,297,193 sq yds  
 Rollover Bay Sand Bars.....1,520,000 sq yds  
 East Bay Water Access Channel.....200,000 sq yds

Sand Volumes

Rollover Bay Sand Bars (new depth 1.5') 760,000 cu yds  
 East Bay Access (nominal depth 6') 300,000 cu yds

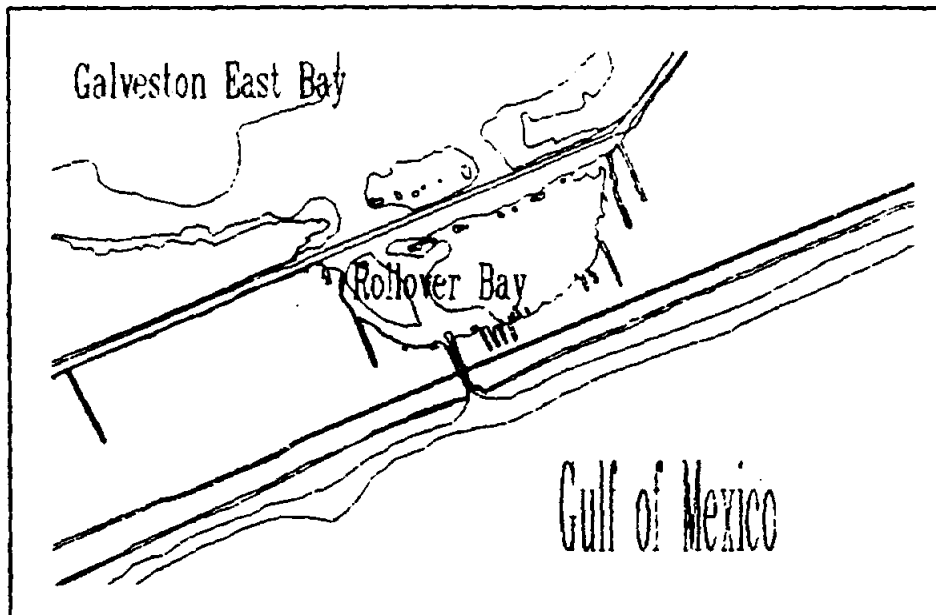

Figure 2. Present View of Rollover Bay

This means that, on the face of it, we have the sand available to complete the plan as described.

Briefly, the East Bay saline water access channel will connect the deepest part of the Rollover fish pass bay mouth with the East Bay three foot contour. The channel will cross the Gulf Intra-coastal Waterway. This should keep much of the flood tide in a cohesive stream through Rollover bay and reduce the water velocities amongst the marshland plants. Additionally, of course more of the saline water will access East Bay.

Totals:

\*\*\*\*\*

Sand available	1,060,000 cu yds
Sand required	820,900 cu yds

\*\*\*\*\*

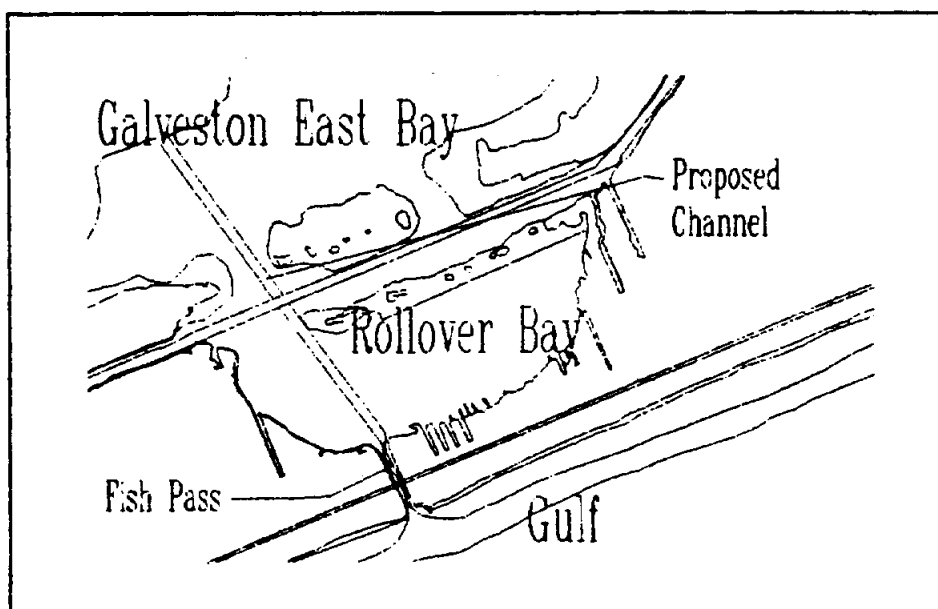

Figure 3. Rollover Bay after proposed dredging

## APPENDIX II

This appendix contains the results of our survey of the Bolivar Peninsula beaches.

The survey took place on Sunday November 12, 1989 from 08:59 until 13:20. Tides:

	<u>Lower Low: 0'</u>	<u>Lower High: 0.9'</u>
Galveston Jetties,	Low at 08:54	High at 16:52
Sabine Pass,	Low at 07:55	High at 15:41

This appendix contains the following charts and diagrams:

<u>Page</u>	<u>Figure</u>
2	Photo Copy of NOAA Chart 11331 showing Western area of Survey, Labeled are profiles 1, 2, 3; Accretion, Low Accretion and Neutral beach slopes respectively.
3	Photo Copy of NOAA Chart 11331 showing Eastern area of Survey, Labeled are profiles 5, 6, 7, 8; Erosion, Severe Erosion, Severe Erosion Near Rollover Pass, Severe Erosion Near Rollover Pass North East Side and One mile North East of Rollover Pass beach slopes respectively.
4	Profile 1; Accretion Beach Slope
5	Profile 2; Low Accretion Beach Slope
6	Profile 3; Neutral Beach Slope
7	Profile 4; Minor Erosion Beach Slope
8	Profile 5; Erosion Beach Slope
9	Profile 6; Severe Erosion Beach Slope
10	Profile 7; Severe Erosion Near Rollover Pass
11	Profile 8; Severe Erosion Near Rollover Pass North East Side
12	Profile 9; Beach Slope One mile North East of Rollover Pass

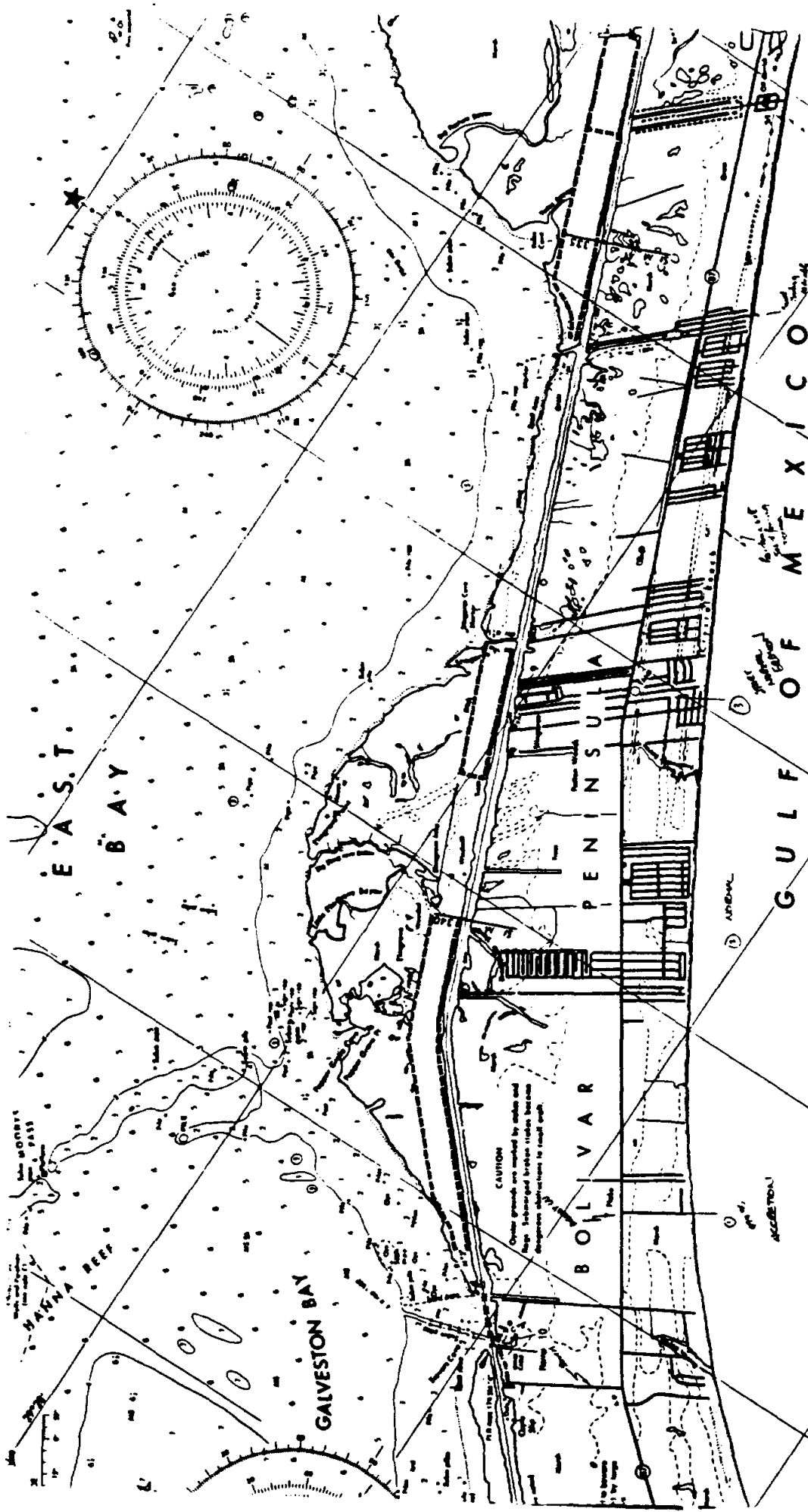

EAST BAY

GALVESTON BAY

BOLIVAR PENINSULA

GULF OF MEXICO

CAUTION  
Some grounds are marked by white and high. Steeply broken bottom. Observe instructions to sound depth.

**CAUTION**

Survey platforms and marks are shown in black. They are used for navigation. They are not to be used for other purposes. They are not to be moved. They are not to be used for other purposes. They are not to be moved.

**CAUTION**

Only marks mentioned here can be used for navigation. They are not to be used for other purposes. They are not to be moved. They are not to be used for other purposes. They are not to be moved.

**POLLUTION REPORTS**

Report all spills of oil and hazardous substances to the National Pollution Center at 800-333-6882 (not toll) or to the nearest U.S. Coast Guard facility. A telephone communication is recommended (24 Hr. 24 Hr.).

**RULES OF THE ROAD**

Navigation rules from the right of way in general. See also the rules of the road in general. See also the rules of the road in general. See also the rules of the road in general.

**RAZOR REFLECTORS**

Razor reflectors have been placed on many buoys to help you identify individual buoys. They are not to be used for other purposes. They are not to be moved.

**SAFETY HINTS**

1. Keep your eyes up to look for changing conditions. 2. Monitor conditions when you receive them. 3. Monitor conditions when you receive them. 4. Monitor conditions when you receive them. 5. Monitor conditions when you receive them.

**WARNING**  
The product markings will not help you identify the product. They are not to be used for other purposes. They are not to be moved.

**STORM SIGNALS**

These signals are used to indicate the severity of the storm. They are not to be used for other purposes. They are not to be moved.

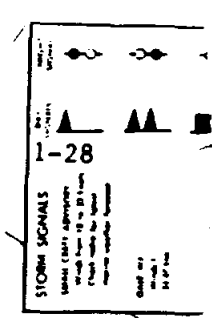

**NOTE**  
This chart is based on the latest available information. It is not to be used for other purposes. It is not to be moved.

**NOTE**  
This chart is based on the latest available information. It is not to be used for other purposes. It is not to be moved.

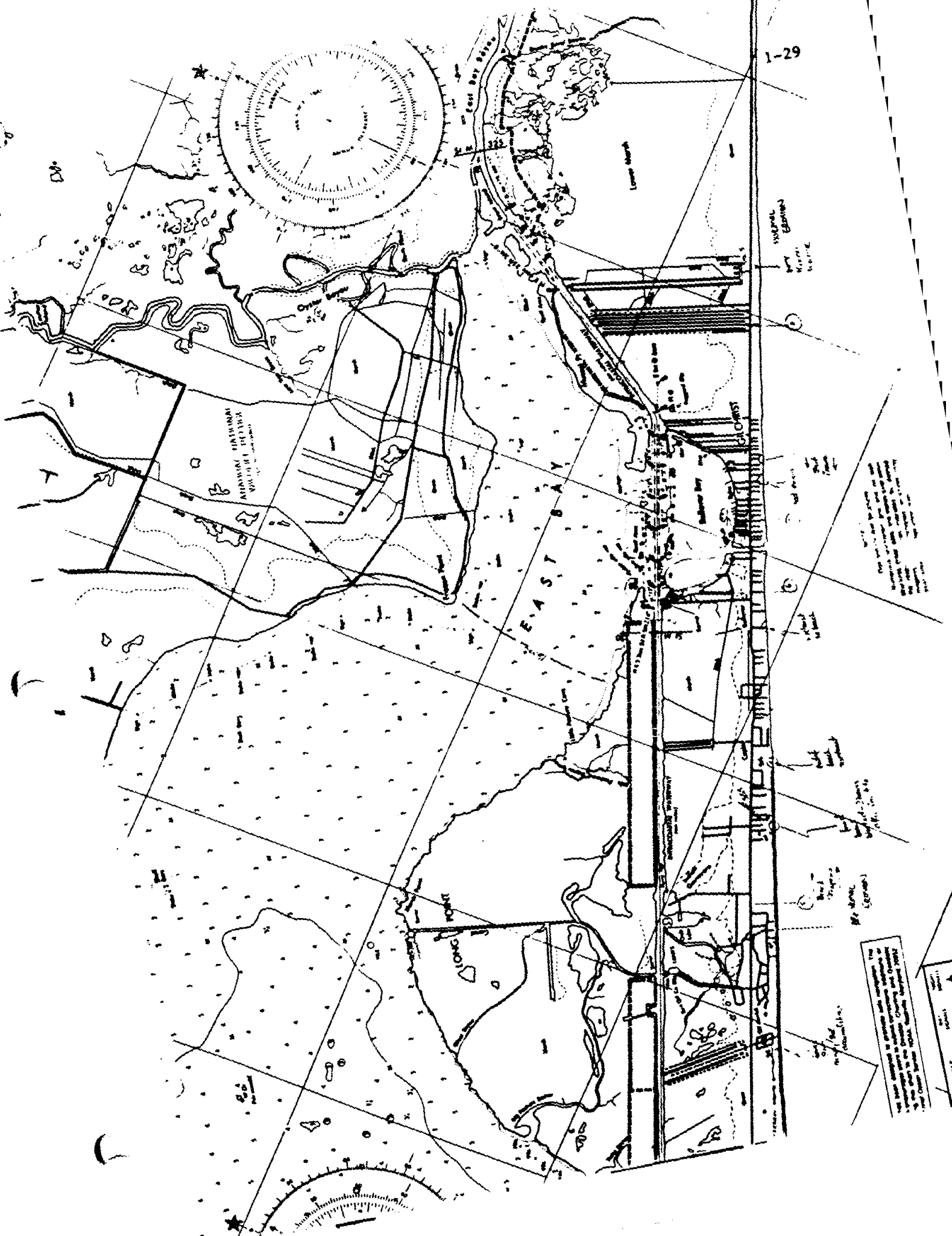

# Accretion Beach Slope Heights exaggerated

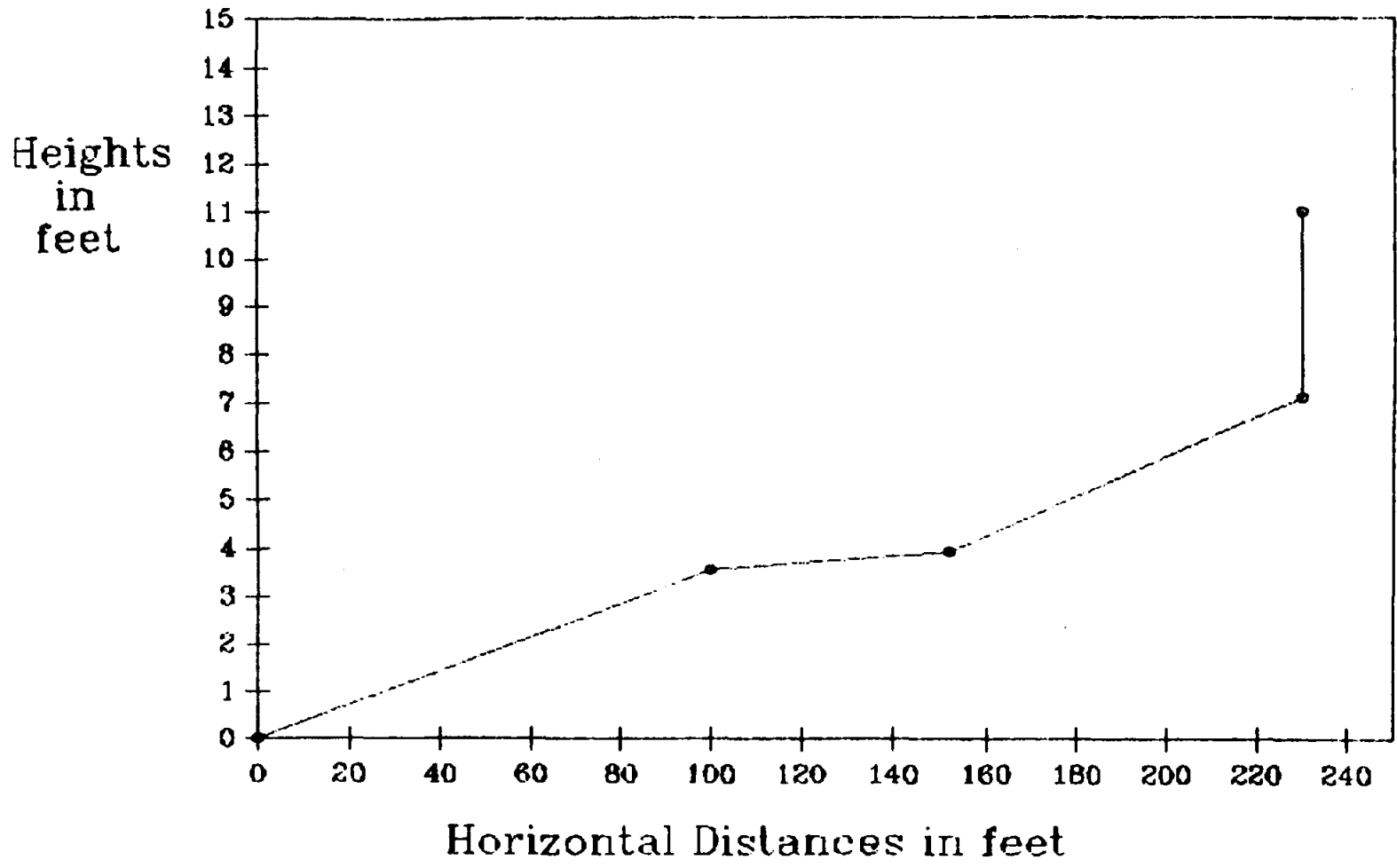

# Low Accretion Beach Slope Heights exaggerated

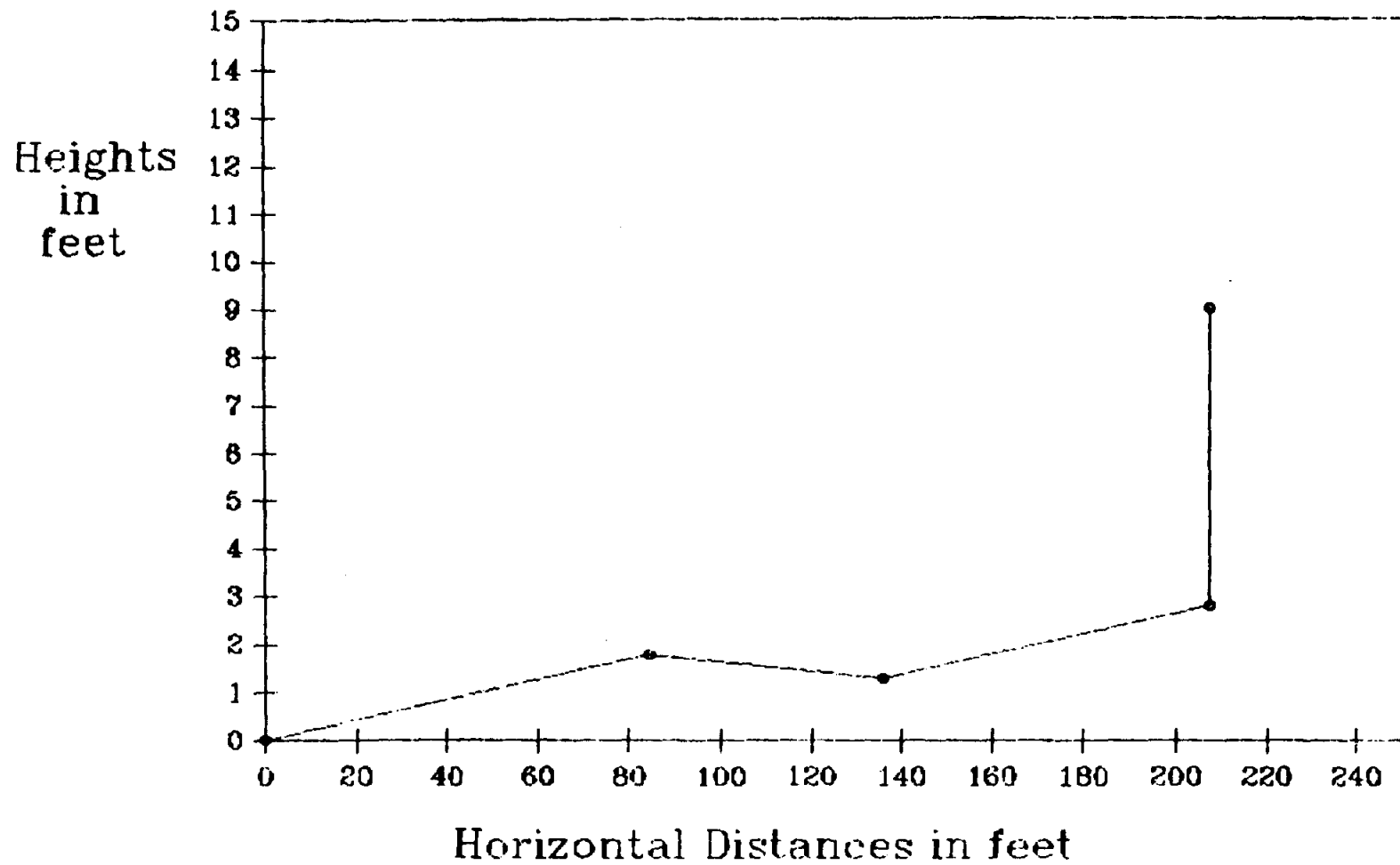

# Neutral Beach Slope Heights exaggerated

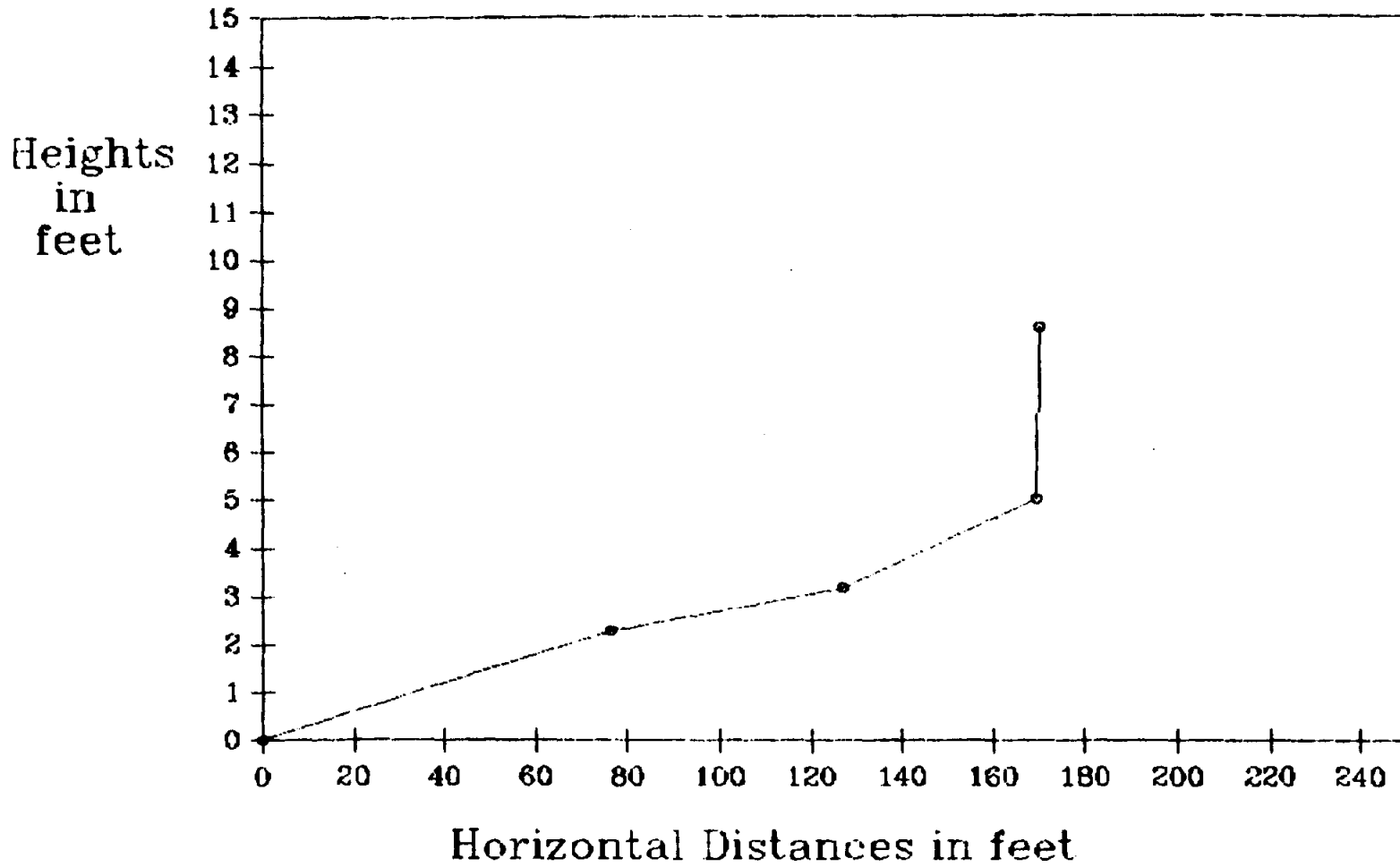



Minor Erosion Beach Slope  
Heights exaggerated

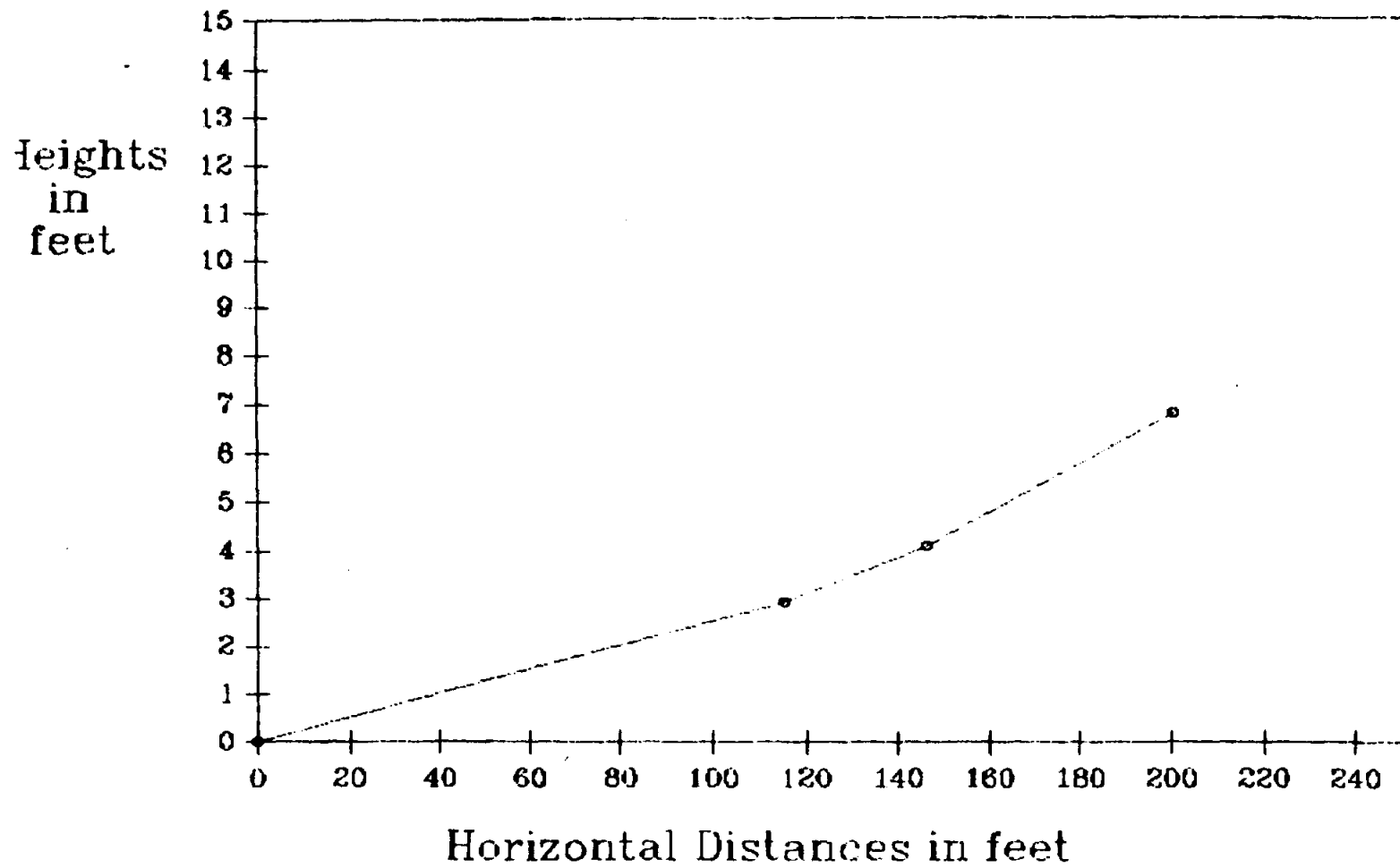

# Erosion Beach Slope Heights exaggerated

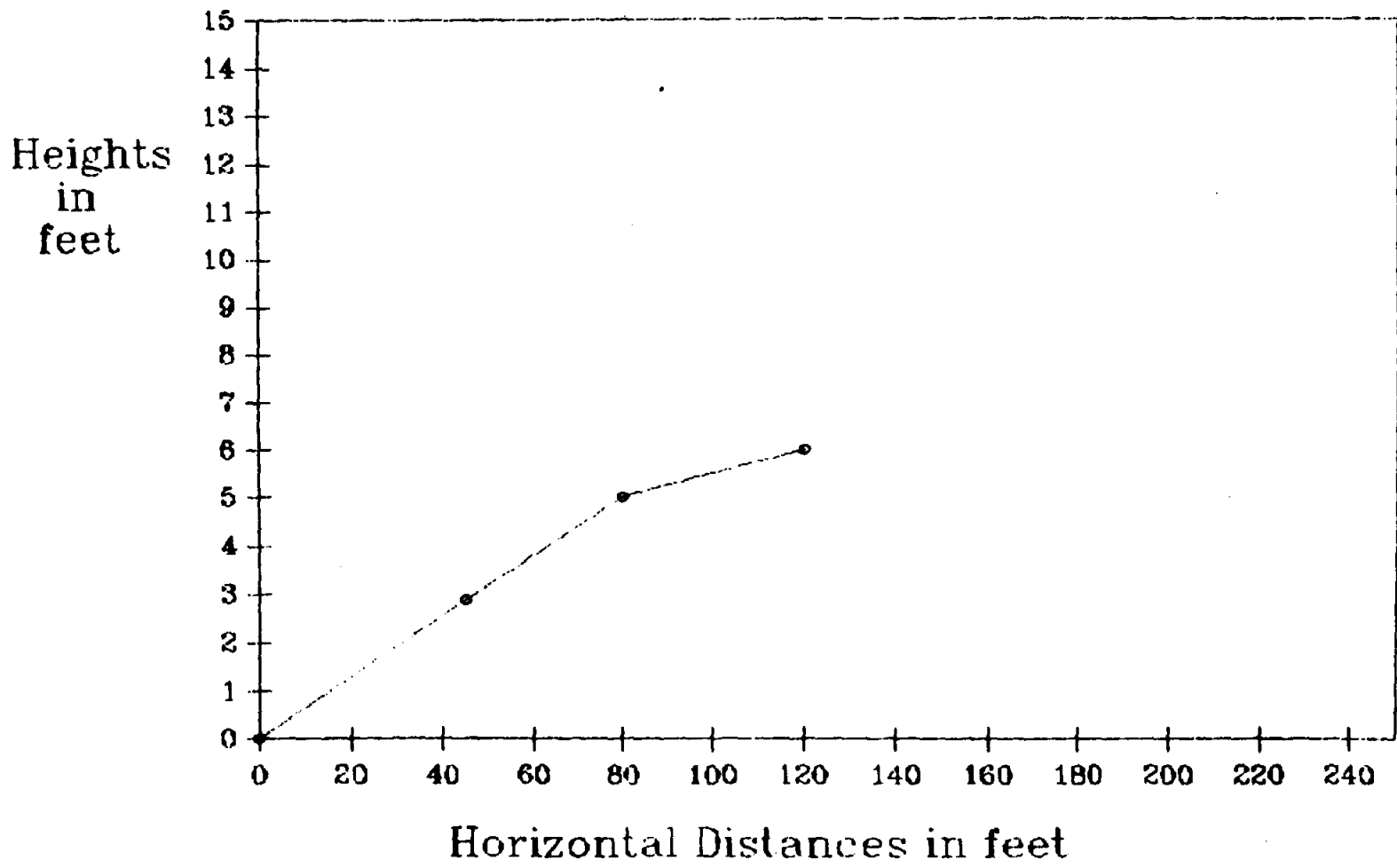

Severe Erosion Slope  
Heights exaggerated

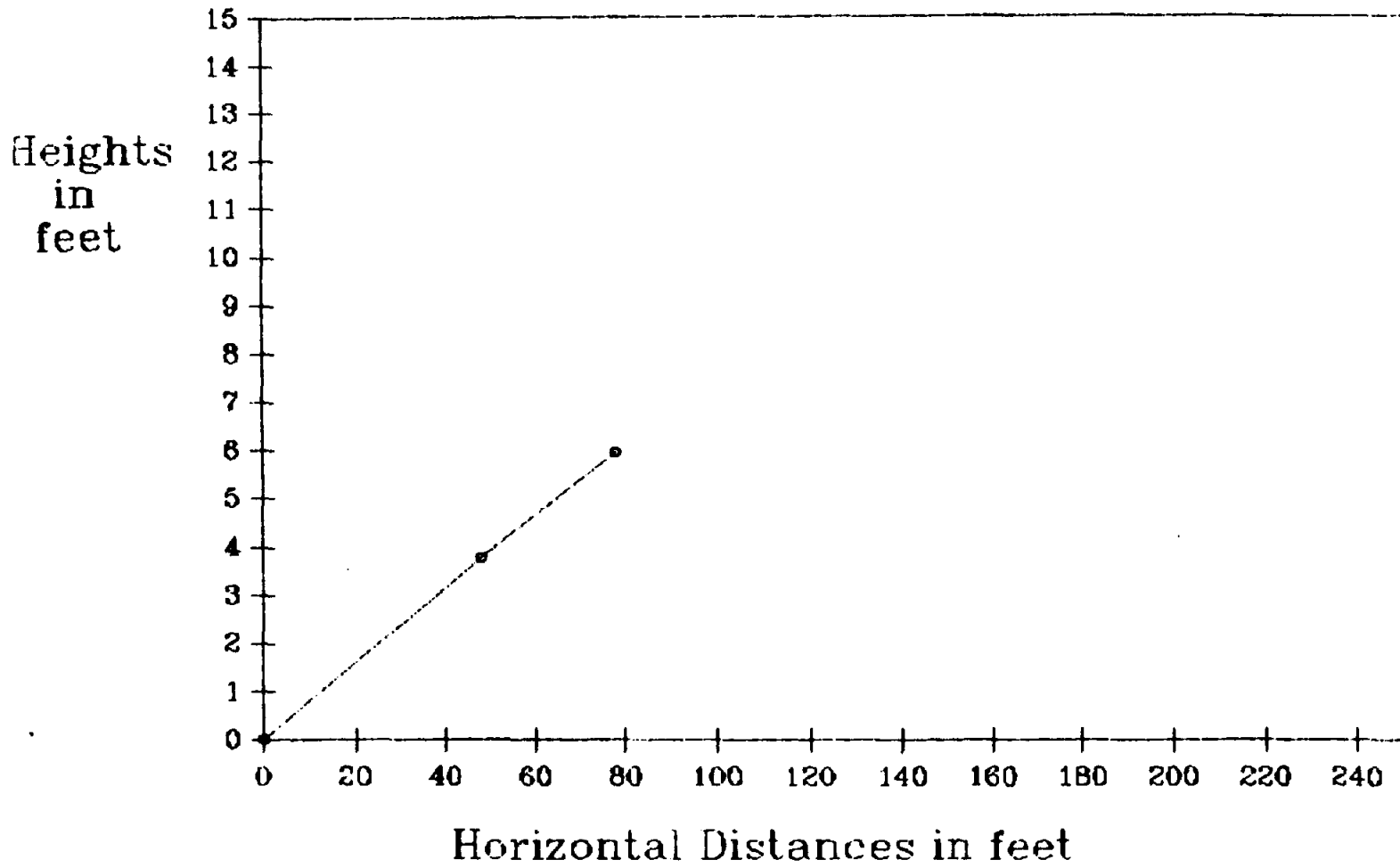

Severe Erosion Near Rollover Pass  
Heights exaggerated

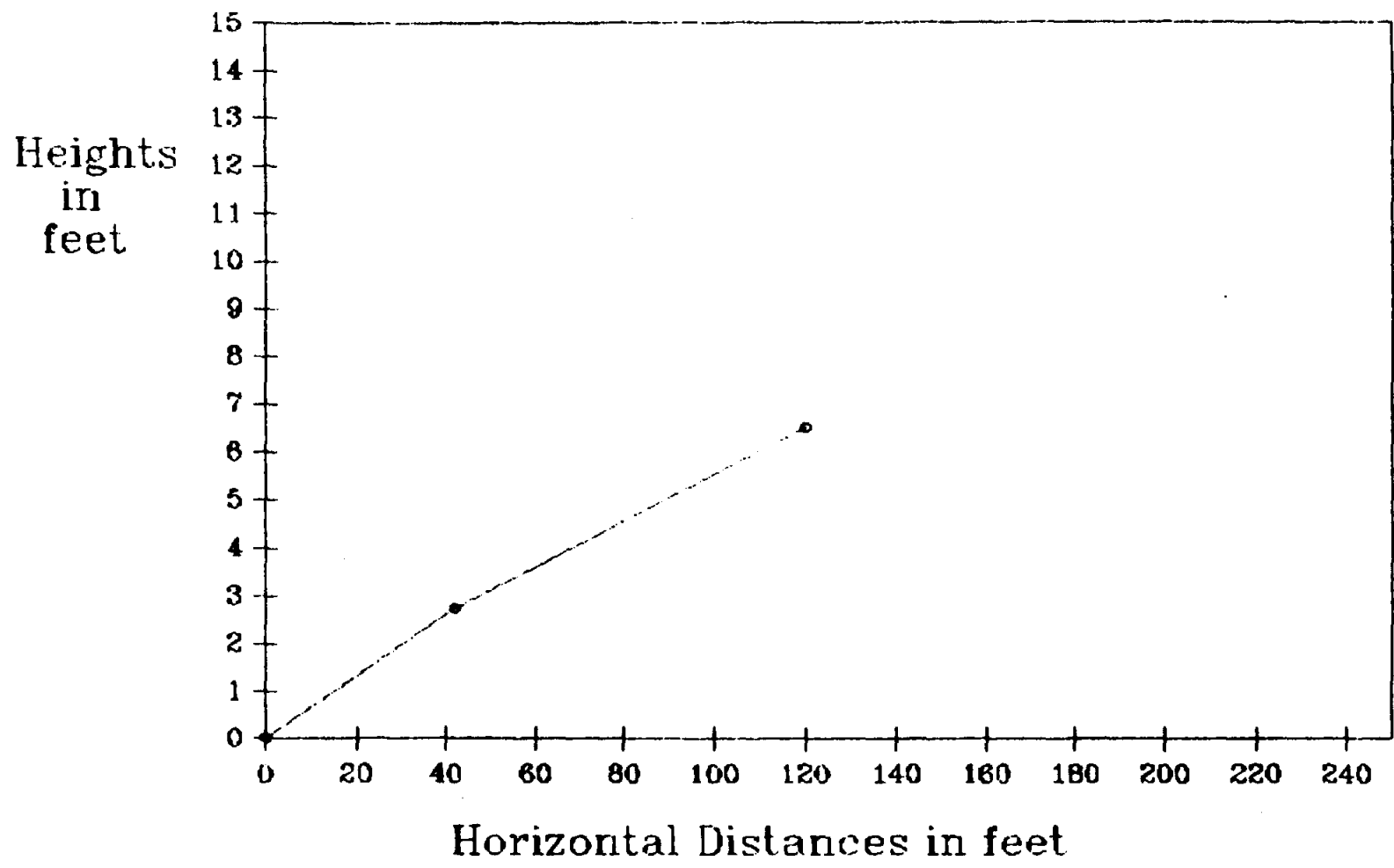

# Severe Erosion Near Rollover Pass North East Side Heights exaggerated

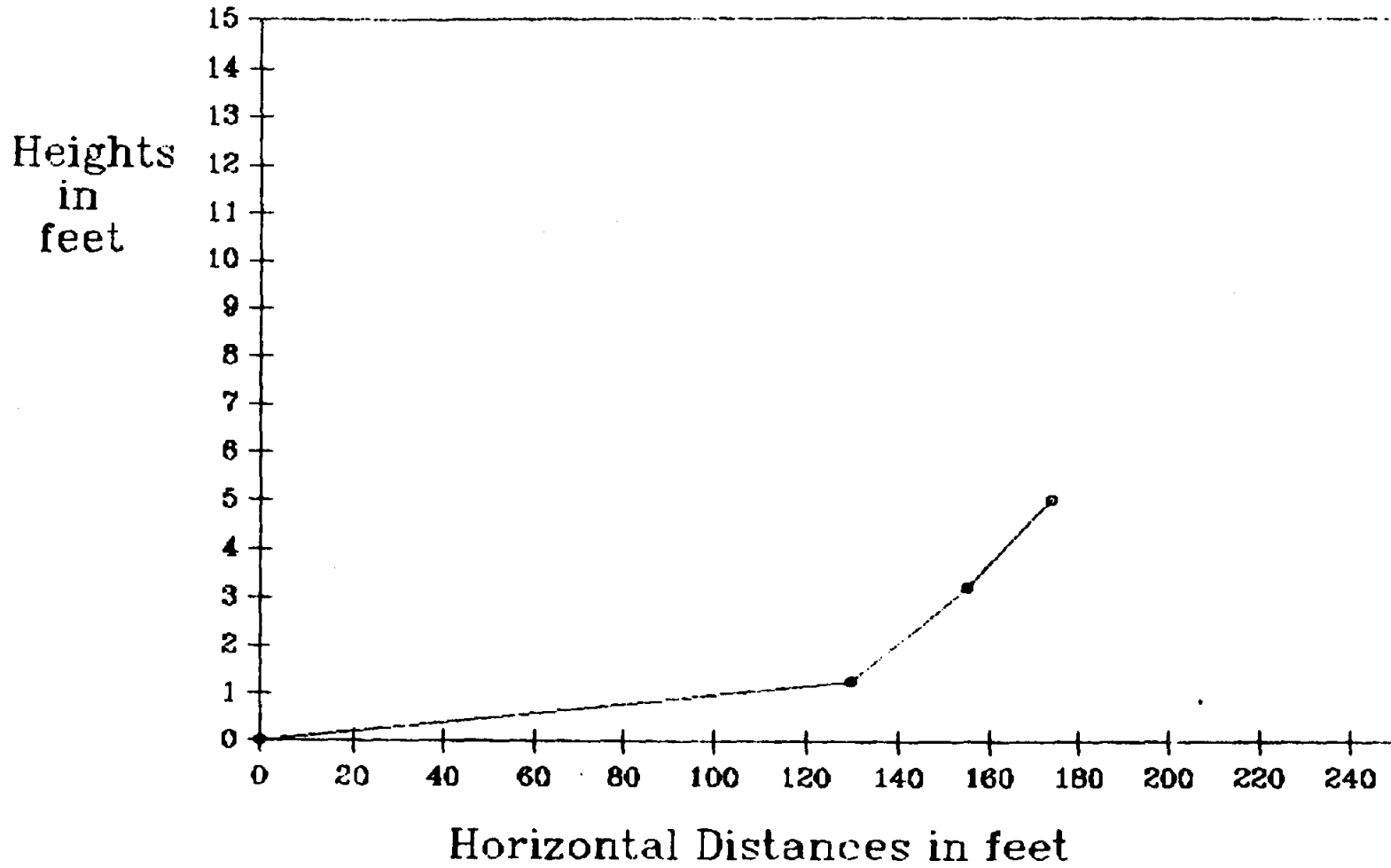

Beach Slope One mile North East of Rollover Pass  
Heights exaggerated

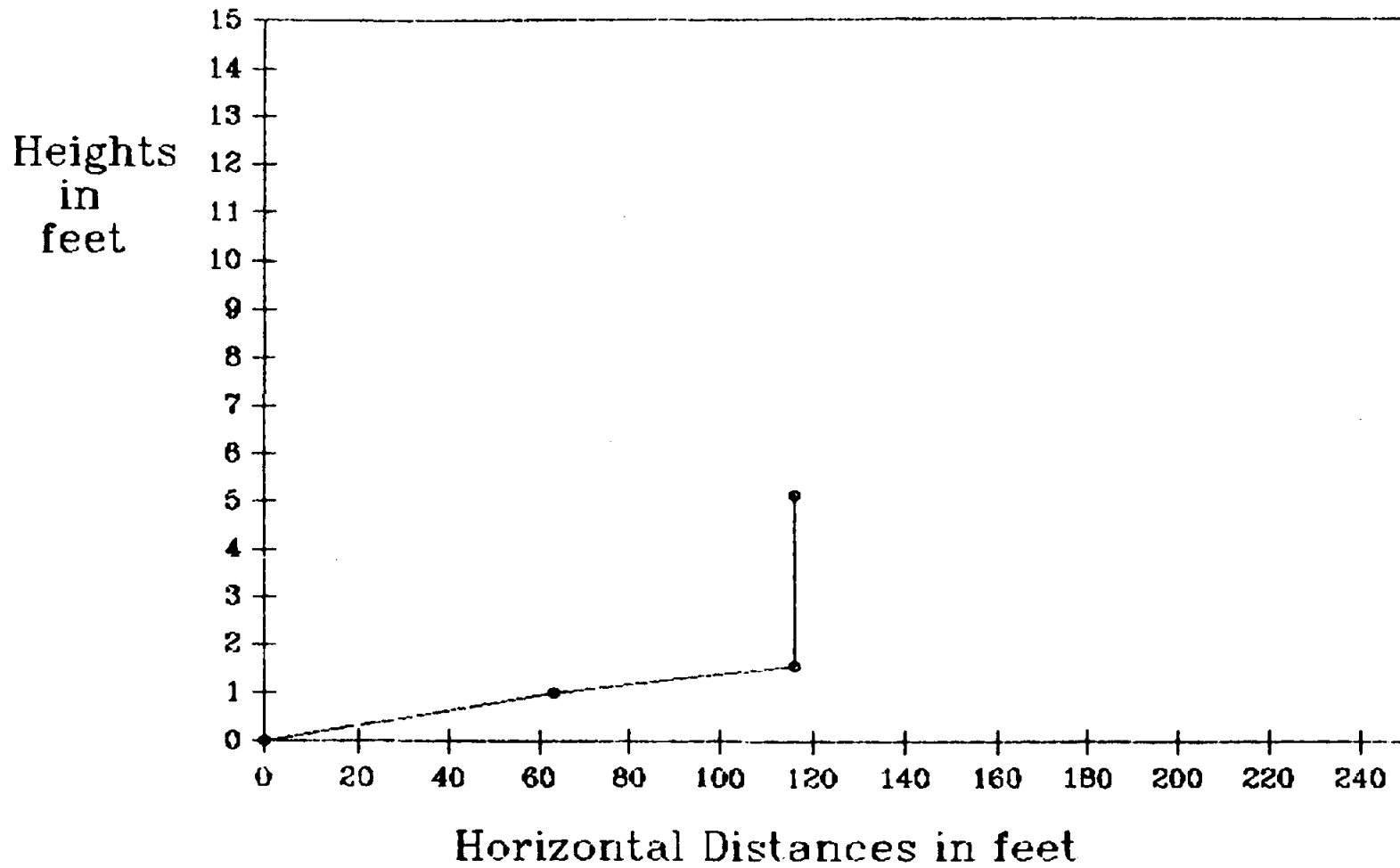

## APPENDIX III

### Rollover Bay Sand Analysis

The following are the S-curves from which we derived our sand findings.

The sites' locations in Rollover Bay are described in Chapter Four. Also included in chapter four's discussion of the sand samples is the raw data from which we derived these S-curves.

The S-curves themselves are a plot of the grain size distribution on the Y axis, which progressively gets coarser; and on the X axis, is a function of sand grain size. The function of grain size is Grain-phi from the following formula:

$$\text{Grain-phi} = -\log_2(\text{nominal grain diameter in mm})$$

<u>Graph</u>	<u>Description</u>
1	S-curve Gulf beach sand sample 0ft-1ft
2	S-curve Rollover Bay Site #1 0ft-1ft
3	S-curve Rollover Bay Site #1 1.5ft-3ft
4	S-curve Rollover Bay Site #2 0ft-1.5ft
5	S-curve Rollover Bay Site #2 1.5ft-2.5ft
6	S-curve Rollover Bay Site #3 0ft-1ft
7	S-curve Rollover Bay Site #3 1ft-2ft
8	S-curve Rollover Bay Site #3 2.5ft-3ft

S-Curve : Beach (Gulfside) Offt - 1ft

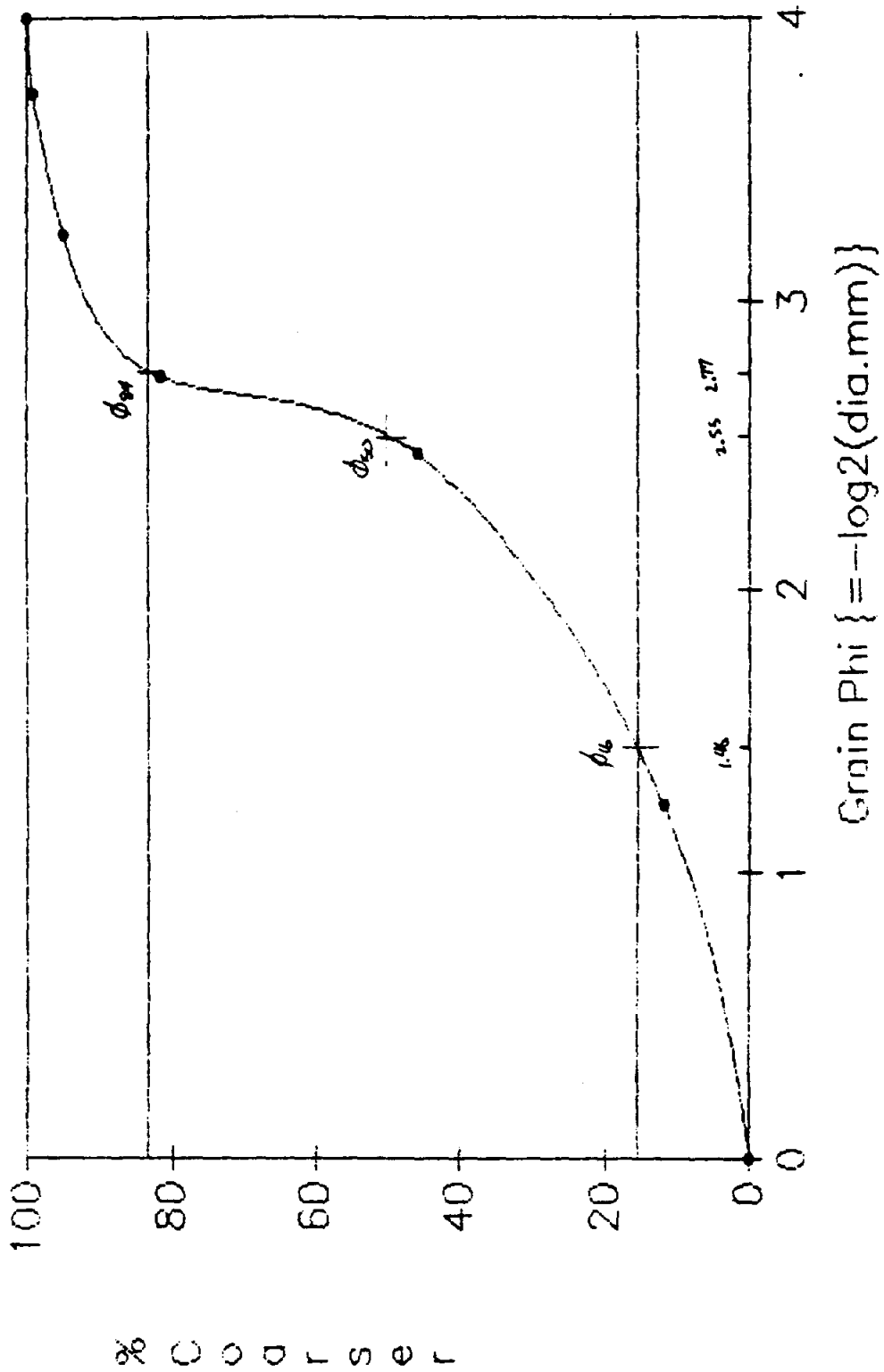

5



S-Curve : Bay#1 Dft--1ft

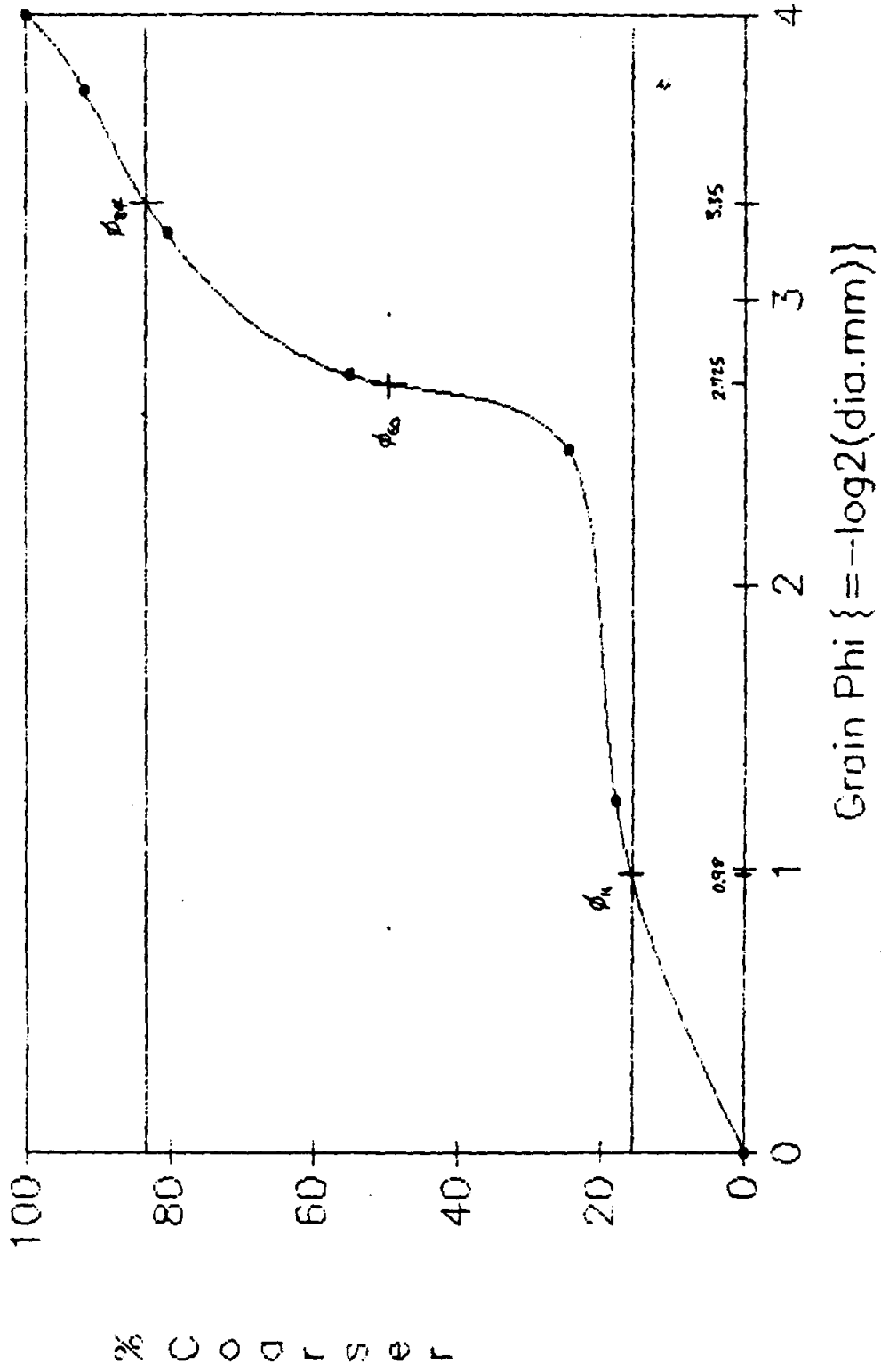

S--Curve : Bay#1 1.5ft-3ft

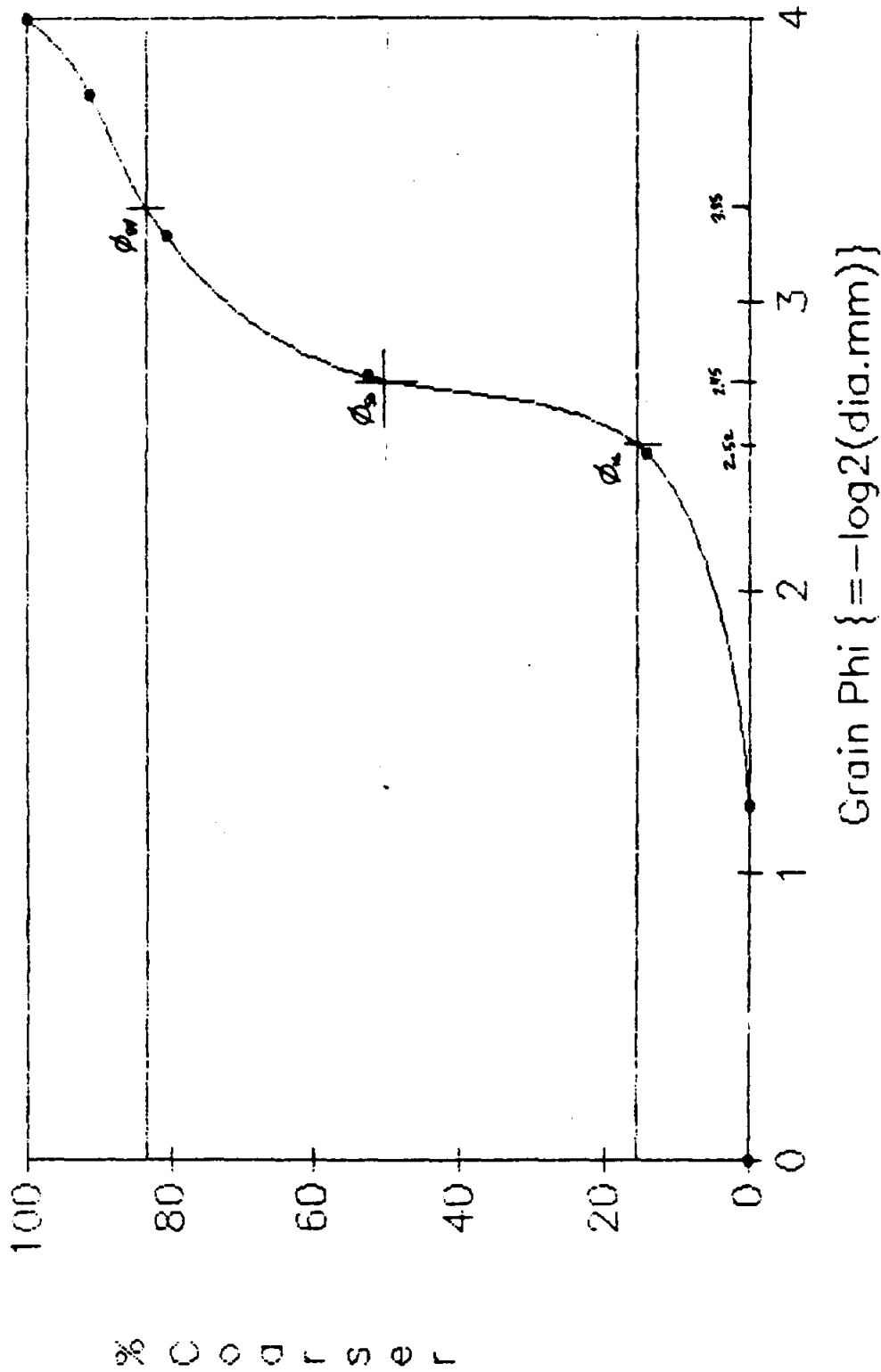

F

Rollover Bay#2: 1.5ft

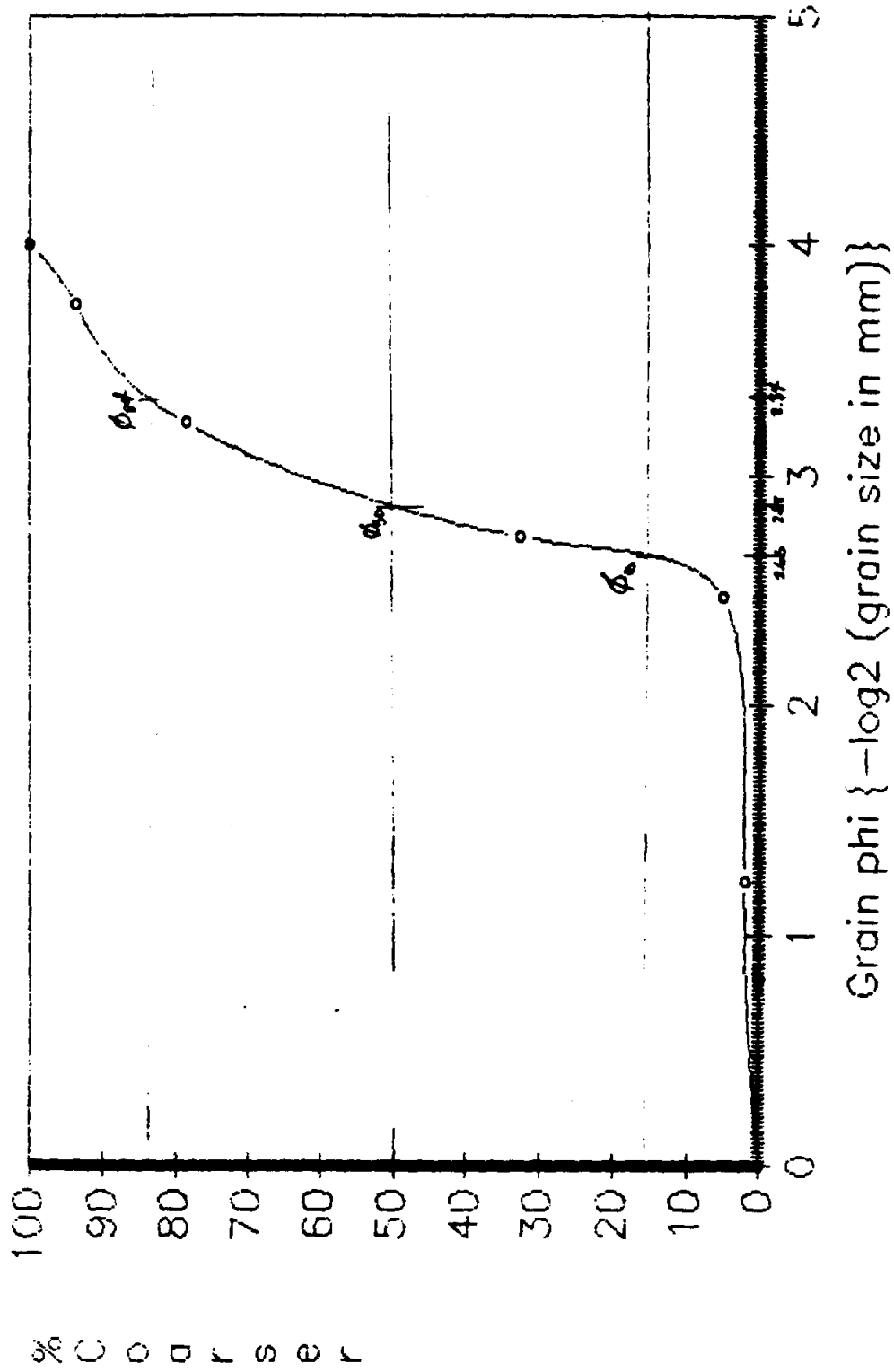

$$M_{\phi} = 2.76$$
$$\sigma_{\phi} = 0.34$$

Rollover Bay#2: 2.5ft

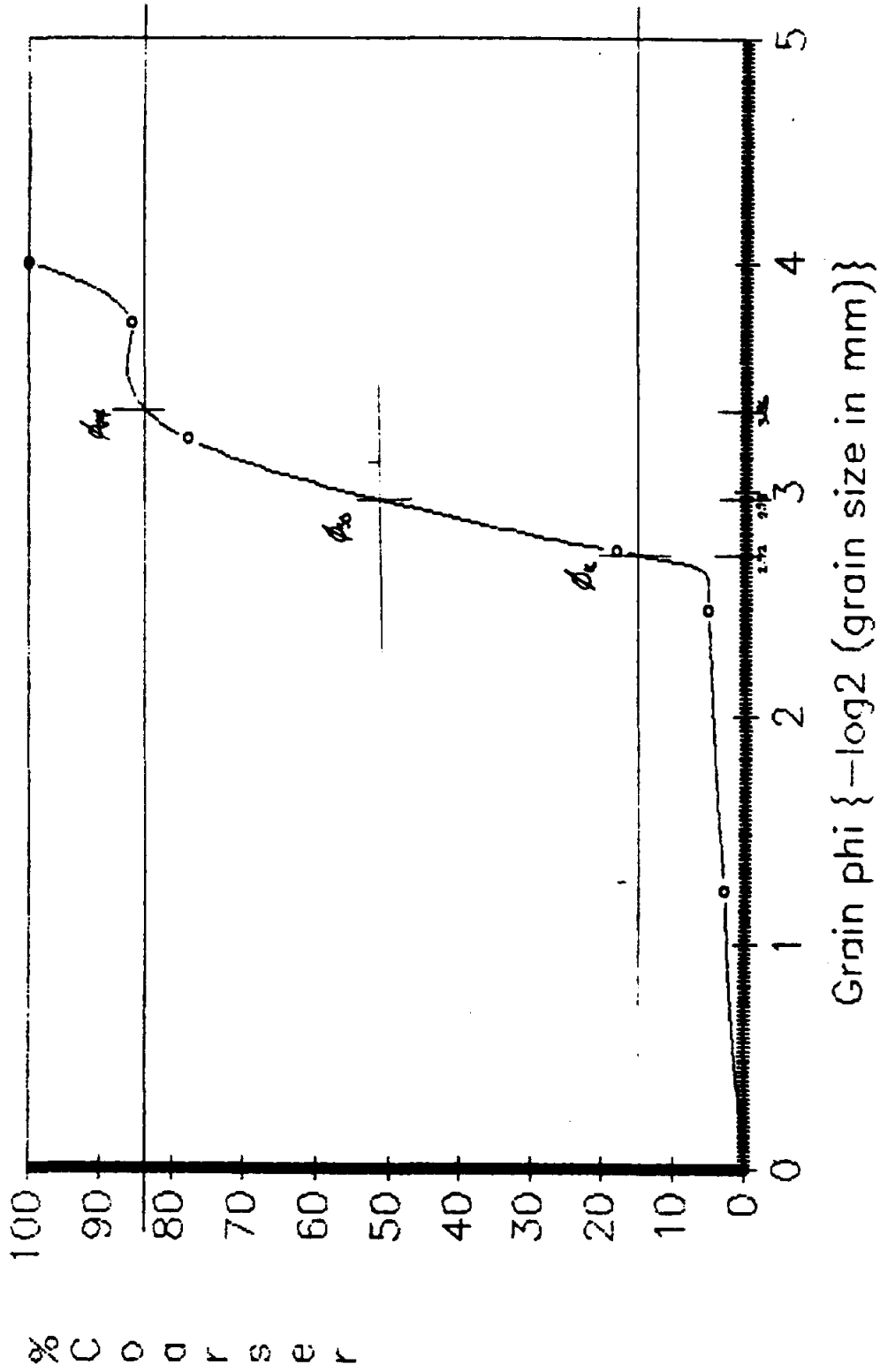

S-Curve : Bay#3 0ft-1ft

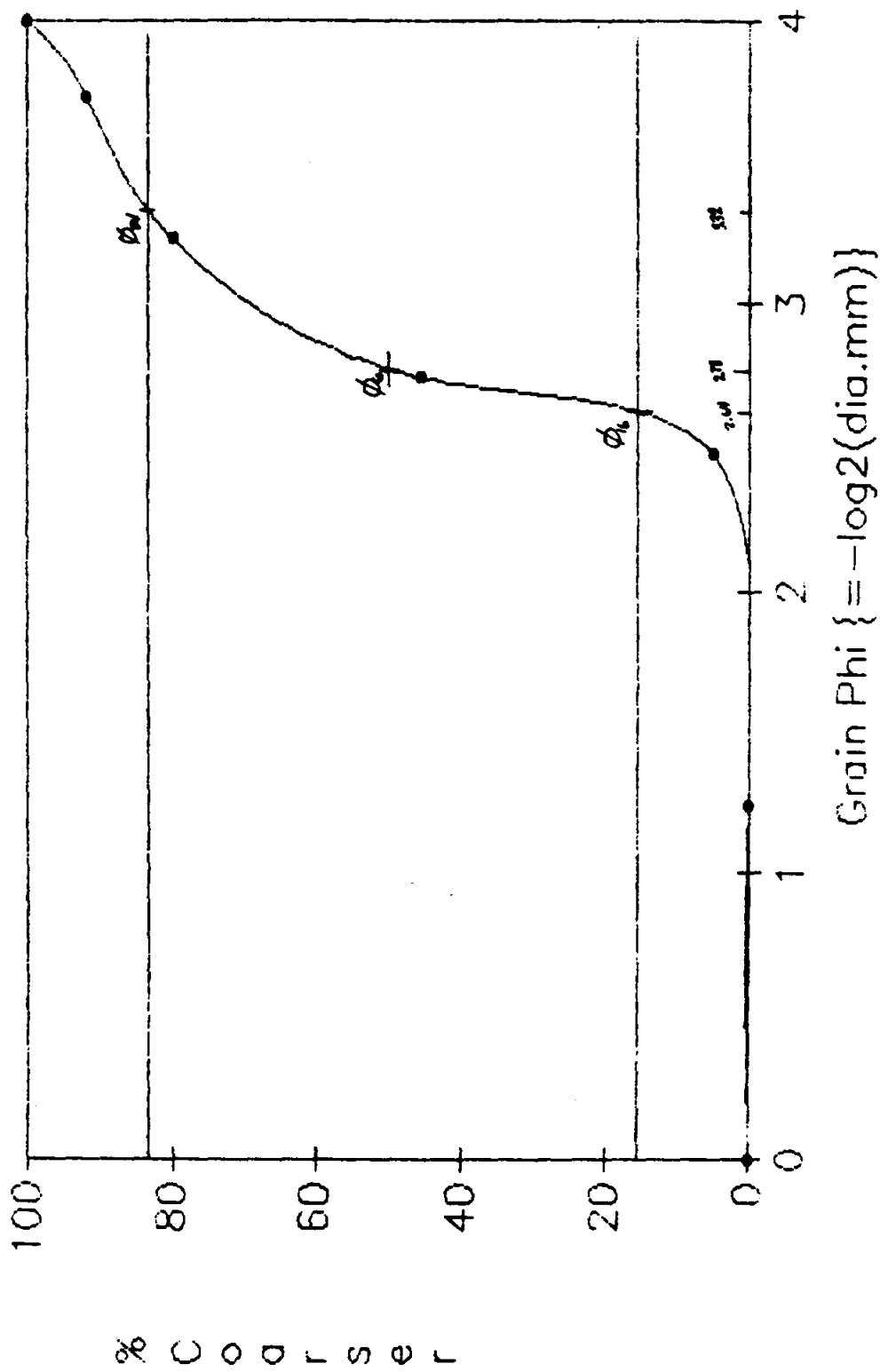

S-Curve : Bay#3 1ft-2ft

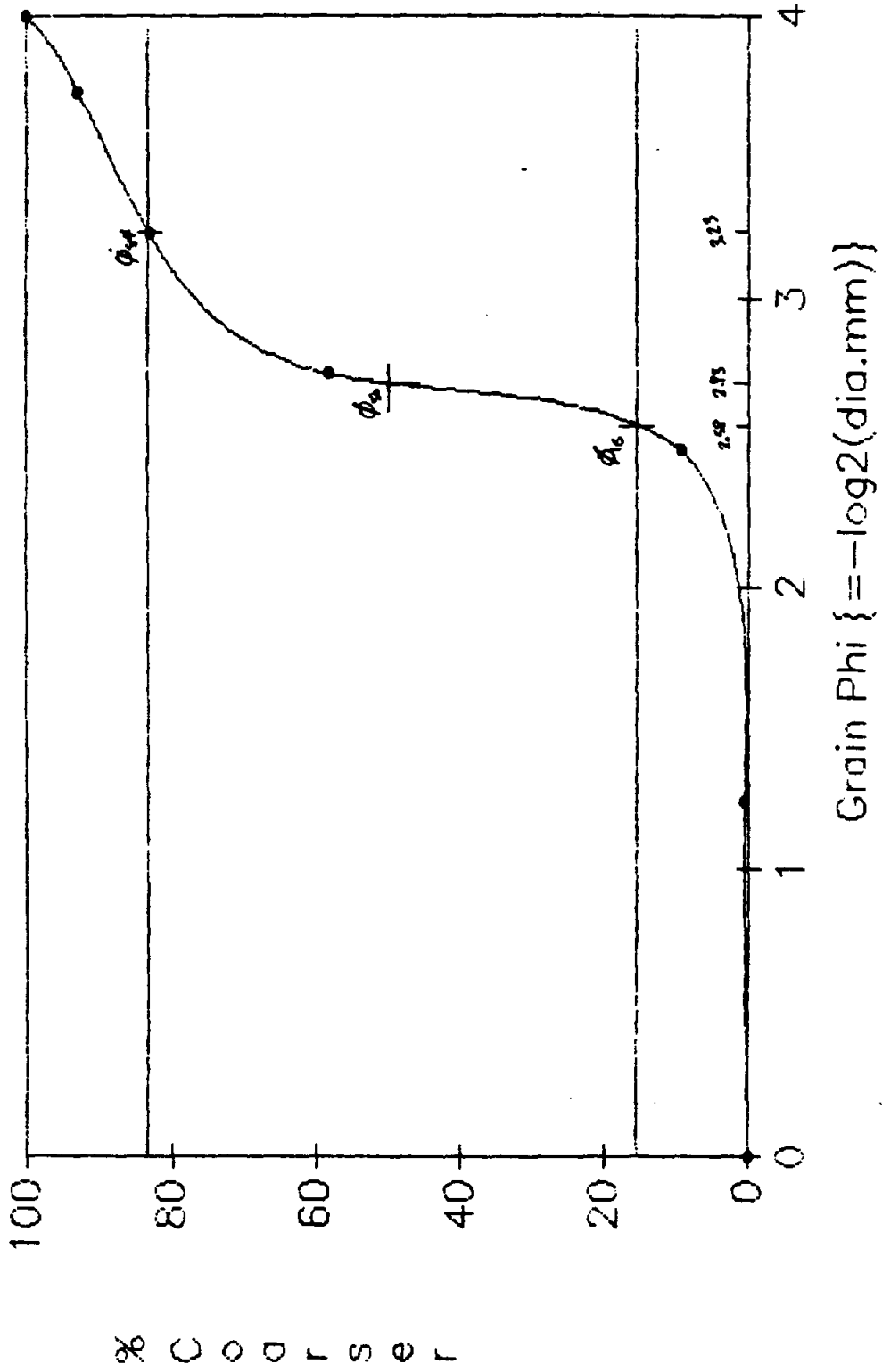

S-Curve : Bay#3 2.5ft-3ft

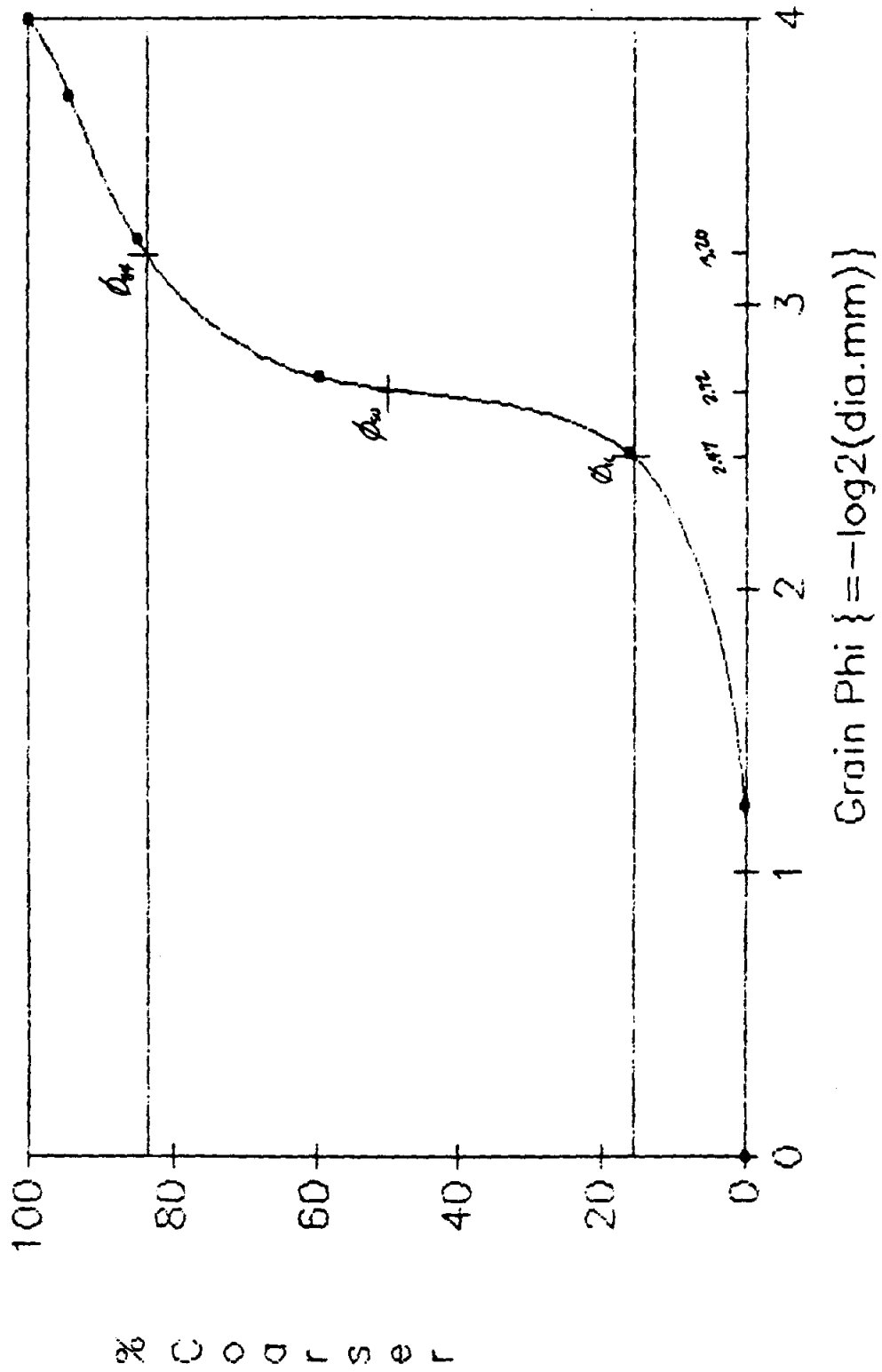

**APPENDIX IV**  
**Computation of Overfill Factor Ra**

The following computations were made according to the method set out in the COE shore Protection Manual, who attribute the formulas to James (1974).

We used the S-curves in Appendix III to phi values at three different percentiles; 16%, 50% and 84%. From these values we calculated a Mean-phi which is equal to the sum of the three values divided by three. We also found a Sigma-phi mean value which is equal to the phi values at the 84% plus the 16% divided by two.

Mean-phi and Sigma-phi are used as a statistical tool in the formulae:  $Y \text{ entry} = \text{Sigma-phi (borrow)} / \text{Sigma-phi (native)}$   
 $X \text{ entry} = [\text{Mean-phi (borrow)} - \text{Mean-phi (native)}] / \text{Sigma-phi(native)}$   
 The X and Y entry values are used to enter James' Ra curves.

Our values from the S-curves are as follows:

<u>Site</u>	<u>Depth(ft)</u>	<u>Mean-phi</u>	<u>Sigma-phi</u>
Gulf	0-1	2.26	0.655
Bay #1	0-1	2.35	1.185
	1.5-3	2.87	0.415
Bay #2	0-1.5	2.96	0.34
Bay #3	0-1	2.91	0.34
	1-2	2.85	0.325
	2-3	2.80	0.365

From these entry values we get the following Ra values:

Averaged values-Bay sites 1&3.....7 < Ra < 10

Bay Site #1 0-3ft.....Ra=2.5

Bay Site #1 0-1ft.....Ra=1.4



## Chapter 2 - Jetty Design

### Table of Contents

Abstract.....	1
2.1 Introduction.....	1
2.1.1 Problem Description.....	1
2.1.2 Project Description.....	2
2.1.3 Review of Jetty Type.....	2
2.2 Hydraulic Factors Existing at ROP.....	4
2.2.1 Historical Changes.....	4
2.2.2 Tidal Range.....	5
2.2.3 Influence of East Bay.....	6
2.2.4 Wave and Current in the Pass.....	6
2.2.5 Wave and Current in the Gulf.....	7
2.2.6 Storm Surge and Overwash.....	9
2.2.7 Origin and Deposition of Sediment.....	9
2.2.8 Existing Status of Gulf/Bay System.....	10
2.2.9 Proposed Changes to ROP Hydraulics.....	10
2.2.10 Effects on Sediment Transport.....	11
2.3 Preliminary Jetty Description.....	12
2.3.1 Selection of Jetty Type.....	12
2.3.2 General Layout.....	14
2.3.2.1 Jetty Length.....	14
2.3.2.2 Jetty Spacing.....	15
2.3.3 Stability of the Rubble-Mound Jetty.....	15
2.3.3.2 Selection of Stability Coefficient.....	15
2.3.3.3 Unit Weight Calculations of Armor Units.....	16
2.3.4 Design of structure Cross-section.....	16
2.3.4.1 Crest Elevation and Width.....	16
2.3.4.2 Concrete or Asphalt Cap.....	17
2.3.4.3 Thickness of Cover Layer.....	17
2.3.4.4 Bottom Elevation of Primary Cover Layer.....	17
2.3.4.5 Toe Berm for Cover Layer Stability.....	18
2.3.4.6 Structure Head and Lee Side Cover Layer.....	18
2.3.4.7 Secondary Cover Layer and Underlayers.....	19
2.3.4.8 Bedding Layer and Filter Blanket Layer.....	19
2.3.4.9 Scour Protection at Toe.....	20
2.3.4.10 Toe Berm for Foundation Stability.....	20
2.3.5 Stability of Rubble Foundation and Toe Protection.....	20
2.3.6 Cost-Benefit Analysis.....	20
2.3.7 Conclusions and Recommendations.....	22
References.....	23

## Chapter 2 - JETTY DESIGN

Designers: Nicholas G. Kyrios & Miles F. Gathright

### Abstract of Jetty Design

The jetty design process incorporates two distinct phases. The analysis of the hydraulic situation defines the erosion problem and the type of solution. The preliminary jetty design derives the physical structure whose performance will achieve the proposed solution.

#### 2.1 Introduction

2.1.1 Problem description - The major concern of the local community, as expressed to us at their town meeting on Wednesday, September 13, 1989, is the alarming rate of erosion occurring on the Gulf beaches near Rollover Pass. The situation along the Rollover beaches constitutes the most severe loss of property and beach on Bolívar Peninsula's Gulf coast. Surveying the beach profiles to the NE and SW of Rollover Fish Pass proved that the most eroded profiles extended for a distance of two miles to the NE and three miles to the SW of the pass. The residents would like to keep the Fish Pass open since it is an important economic resource yet they don't want to lose any more homes to the sea.

The erosion is attributed to the tidal flow through Rollover Pass. The general understanding is that a predominantly flood tide through Rollover Pass carries sediments from the littoral drift into Rollover Bay. The sand deposited there constitutes a deficiency of suspended sand in the littoral current running along the downdrift beach. The deficiency causes the water to lift sediment from the nearshore area and the beach in order to replenish its suspended load. The loss of that sand is the essence of the beach erosion problem.

2.1.2 Project description - The problem we propose to solve with our jetty design, is the loss of sediment supply from the nearshore zone downdrift of Rollover Pass. The design method is to extend two structures from the beach out into the littoral current, trapping the littoral transport updrift of Rollover Pass and keeping it from entering the bay. The bay will experience less shoaling and current constriction. The structures on the Gulf will cause sand to accrete at their bases, forming a sand trap. The sand bypass system can then redistribute the accreted sand, returning it to the beaches as needed.

2.1.3 Review of Jetty types - There are several types of structures used to stop beach erosion:

Offshore breakwaters (Fig. 3) are designed to reduce the wave energy between it and the beach, creating an

accretionary zone. Note the tombolos, sand building up and bringing the shoreline out towards the breakwater. The breakwater does not stop littoral flow, which means sediments would still disappear into Rollover Bay. Also, breakwaters increase the erosion on the downdrift beaches.

Groin fields (Fig. 4) have been used in Miami and Galveston with little success. The circulating current developed between the groins carries sediment away rather letting it accrete. They do not trap enough sediment to create a nice beach and do increase erosion on beaches downdrift of the groin field.

A weir jetty system is shown in Fig. 5. The weir faces the predominant littoral current allowing sediments into the low energy zone within the jetties. From this protected sandtrap a dredge vessel can safely pick-up and redistribute the sand. The weir would not work well at Rollover Pass since we want to keep the sediments out of the flood dominated inlet and don't need the expense of a protected dredging area.

Sand bypassing over an inlet is depicted in Fig. 6. The sand is trapped by the updrift jetty, creating an accreting beach. The sand trapped there is picked up and pumped over the inlet to the beach on the other side. The idea is to negate the effect of the inlet as a sand sink,

letting the sediment supply continue its migration down the beach. This inlet/bay configuration is similar to that at Rollover Pass. The jetties at the inlet mouth also keep the channel open for navigation or tidal flow. This is the type of jetty system that would work best at Rollover Pass.

## 2.2 Hydraulic Factors Existing at Rollover Pass

2.2.1 Historical changes in inlet physiography - The changes in beach width and profile and the location of the vegetation line and mean low waterline as calculated from aerial photographs, satellite photographs and surveys depict the historical changes that have occurred. The map in Fig. 7 (Morton 1975), shows measuring stations along the Bolivar Peninsula. Rates of erosion were found for each spot over three different time frames; 1882-1930, 1930-1955 and 1955-1970. Stations 38-49 fall within the area affected by Rollover Pass.

Charting the erosion rates for easy comparison produced Fig. 8. The data from 1882-1930 is series one, the blue line. This shows erosion that is attributed to the damming of the Mississippi and its tributaries which decreased the natural movement of sediments into the Gulf.

The data for 1930-1955 (series 2 - red line) shows a stabilization of the Bolivar Peninsula beaches as an

equilibrium condition was approached. This is due to the beaches having adjusted their characteristics to the available sediment supply.

The data from 1955-1970 (series 3 - green line) depicts the conditions since the opening of Rollover Pass. The erosion rates are higher, near the pass, than at any time, with an average loss of 15 feet per year.

Sea level rise, whether due to land subsidence, global warming or any other reasons, causes a relative decrease in land above mean low water. The graph in Fig. 9 depicts the sea level rise as measured at Galveston. The data from 1905-1970 shows about a 1.3 ft. rise in sea level relative to the land. Using a 1/100 foot slope of the sea bottom near the beach, we can attribute a 130 foot loss of beach over that time to the relative sea level rise.

2.2.2 Tidal range - The lunar tides have a measured range of 1.4 ft. in the Galveston channel and 2.1 ft. in the Gulf (USACOE 1967). Higher changes in water level occur during high wind conditions and storm surge than during normal tide cycles. Strong offshore winds push out the Gulf and Bay waters creating lower tides. Onshore winds and storm surge increase the water height creating higher tides.

2.2.3 Influence of East Bay - Although the tidal range between high and low tide is so small, there is a strong flood tide occurring through Rollover Pass. This is due to a four hour lag between the occurrence of high tide on the Gulf side of the Pass and high tide on the Bay side. The phase difference across this narrow pass creates a predominantly flood tide, meaning that the tide runs into the bay more often than out, and the velocities of the flood tide are greater than the ebb tide (Prather & Sorensen 1972). Data from a 31 hour measurement of the flow velocities through the pass showed a flood tide velocity reaching 6 ft./sec. and an ebb tide maximum of only 2 ft./sec. The estimated flood-tidal prism was five times that of the ebb tidal-prism (Mason 1981). This is the mechanism which is pulling the sediment from the littoral flow into the bay where it is deposited in a low energy environment.

2.2.4 Wave and current in the pass - The current and the waves reflected within the pass create very turbulent water-flow, especially on the Gulf side of the weir. 2 people had already drowned in the Pass this year by the time of the September town meeting. As depicted earlier, there is a strong predominantly flood tide passing through the pass.

We want to keep the current as is since it is the salinity feed for East Bay and a fish migration route.

Reducing the wave energy in the pass is a factor in Mr. Gathright's design.

2.2.5 Wave and current in the Gulf - The wave rose diagram (Fig. 10) depicts the offshore wave data accumulated over ten years, for our general area. Using the data for waves propagating towards and along the shoreline we find two important things.

First, the waves play the major role in creating the littoral flow. At different times of the year the predominant flow direction changes from towards the NE to towards the SW. Overall the flow is to the SW 56-60 % of the time, and towards the NE 44-40% of the time. The transport of sand therefore, occurs in both directions although the net littoral drift is to the SW. This agrees with the findings of previous studies (Bales & Holley 1989, Prather & Sorensen 1984). Considering this we need to build two jetties of equal length to stop the flow of sand into the bay from both directions of littoral flow.

The second aspect of the wave rose is the actual wave heights and the percentage of time that they occur. We made a graph (Fig. 11), from the rose data which shows that the significant wave height is 3.5 feet. The 1/10 wave height, meaning that 90 % of the time waves are less than this



height, is 6.25 feet. These figures are similar to USACOE estimates (USACOE 1967) for the Galveston beachfront.

The wave height controls the distance that the littoral transport extends from the beach. This is because the waves nearshore break when their height = 0.78 times the water depth. It is within this breaking wave zone that the energy is high enough to lift sediments off the sea floor and the beach. This is the mechanism that puts sediments into the littoral transport system. The width of the breaking wave zone is therefore the distance to which our jetties must extend to stop the littoral flow. Our design would stop 80 to 90% of the littoral flow if constructed to a length of 800 feet.

The stability of the jetty structures is designed so as to survive the storm wave conditions likely to be encountered. The significant wave height during a 1/100 year storm is 8.1 ft., giving a design wave height of 8.9 ft (Fig. 12 & 13) (USACOE 1967). This is used to calculate the weight of the stones which will be subjected to the breaking wave energy. We chose to design according to the significant wave height rather than the 1/10 wave height since the jetties are designed to be submerged during the large storm surge needed to allow the larger waves heights to approach the shore.

2.2.6 Storm surge and overwash - Rollover Pass is located at the narrowest and lowest elevation stretch of Bolivar Peninsula. This makes it a likely hurricane overwash area. A 100 year storm would have a predicted storm surge (Fig. 14) of 12.9 feet (USACOE 1984). The 1900 storm had a 14.5 foot surge as measured at Galveston. Hurricane Jerry put water on the parking lot at Rollover Pass.

The land elevation at Rollover is about 5 feet, so we decided to design our jetties to a crest elevation of 6 feet above MLW. This will protect the pass from an increase of storm surge due to piling up of water against a tall jetty, and will protect the jetties by allowing them to be submerged during such a powerful storm.

2.2.7 Origin and deposition of sediment - The predominant force in sediment transport is the littoral drift. Figure 14 is an aerial photograph showing the sediment in the littoral transport and the path it takes. Note the effect of the Sabine jetties pushing a large band of sediment out into the Gulf where it will settle. This constitutes a loss of sediment supply for the downdrift beaches.

Data on the amount of sediment being moved by the littoral current is sketchy, no two researchers agree. An average figure would be about 100,000 cu. yards per year.

The sediment still in the littoral transport system after the effect of the Galveston and Sabine jetties, approaches Rollover Pass where much of the littoral flow is sucked into the bay where more sand is lost. Very little of the sand entering the inlet ever gets back out; the study of suspended sediment samples shows that the sand transport into the bay on a flood tide can be as much as 310% of the transport out on the ebb tide (Bales & Holley 1985).

After Rollover Pass has taken its toll, the water approaching the beaches downdrift of the Pass carries little to no suspended sediment. The energy of the water, however, is the same and therefore it picks up sediment off the downdrift beaches to refill its sediment budget. This is the mechanism of erosion affecting the shoreline near Rollover Pass.

2.2.8 Existing status of Gulf/Bay system - Although the Pass has been stabilized with bulkheads and a weir, the beaches have not stabilized, nor has the bay. Erosion continues on the beach and the bay is being choked off as shoaling continues. The erosional mechanism seems unlikely to stop or be shoaled shut so the beaches can be expected to continue eroding.

2.2.9 Proposed changes to ROP hydraulics - The jetties we are proposing are designed to reach out from the shore and

stop the flow of the littoral transport into the bay (Fig. 15). The jetties will also keep the channel from scouring or shoaling so that the current through the pass will continue as a salinity feed and fish migration route.

2.2.10 Expected effects on sediment transport - The sediment will accrete at the jetty base and be bypassed over the inlet to the beach on the other side. We expect to stop 80 -90 % of the littoral flow from entering the bay but we expect a smaller percentage of the sediment to actually accrete against the jetty. The jetty system will stop the loss of sediment into Rollover Bay and trap the sand where it can easily be reached for bypassing to the eroded beaches.

## 2.3. Preliminary Jetty Design

2.3.1. Selection of jetty type The selection of the type of jetty involved the consideration of several different types of construction. Each method of construction has advantages and disadvantages inherent in its design. The following paragraphs will briefly describe each method and its pros and cons.

**Timber-steel sheet-pile:** This consists of steel sheet-piles driven into the ground between vertical round timber piles and braces. This method was used to construct groins in Galveston in the 1930's. However, by the early 1960's, the outer portion of these groins was damaged if not non-existent. While this is a cheap method, the design life is too short.

**Cantilever-steel sheet-pile:** This is relatively the same as the previous method except that the piles are restrained at the top by a structural steel channel. This is what exists, or partially exists, at ROP. Again, the design life is too short, and the steel that is exposed to the salt water environment degrades to where it is dangerous to the structure itself as well as recreational fishermen.

**Prestressed-concrete sheet-pile:** In this method, the jetty is an impermeable, prestressed concrete-pile with a concrete cap

that is cast in place. Due to the salt water, the concrete contains no steel reinforcement. This would entail the proposed structure being massive and costly. Also, if this structure is damaged, it is not easy to fix.

Rubble-mound structures: Rubble-mound structures are constructed with a core of quarry materials, as well as finer material to fill the voids due to larger stones. This enables the core to be sandtight. The core is then covered by a layer of armor stone. This armor stone, whether granite or concrete, must be heavy enough to be stable against design wave conditions. This structure takes quite a bit of material and is costly. However it has a 100 year design life and has been used successfully along much of the Texas coast.

Much deliberation went into what type of construction should be used. After weighing the factors of cost and design life, it was decided to go with a rubble-mound structure with a granite cover layer. The main reasons for this decision are as follows:

- 1) the structure will act as a barrier to prevent the passage of littoral sediment
- 2) it will be stable against the design wave forces
- 3) excessive scour at the toe of the structure will be prevented
- 4) safe against foundation failure or excessive settlement

- 5) a 100 year design life
- 6) the materials are available in central Texas

### 2.3.2. General Layout

2.3.2.1. Jetty Length After study of the littoral sediment transport, it was decided to stop as much of the sand as possible. To accomplish this, two 800 foot jetties constructed normal to the shore will be proposed. This length enables the jetties to project beyond the breaker zone and stop 80%-90% of the sand transport. A longer jetty was considered, but stopping much more of the sand transport is unrealistic and economically unfeasible. The 800 foot length is believed to be the optimum design length.

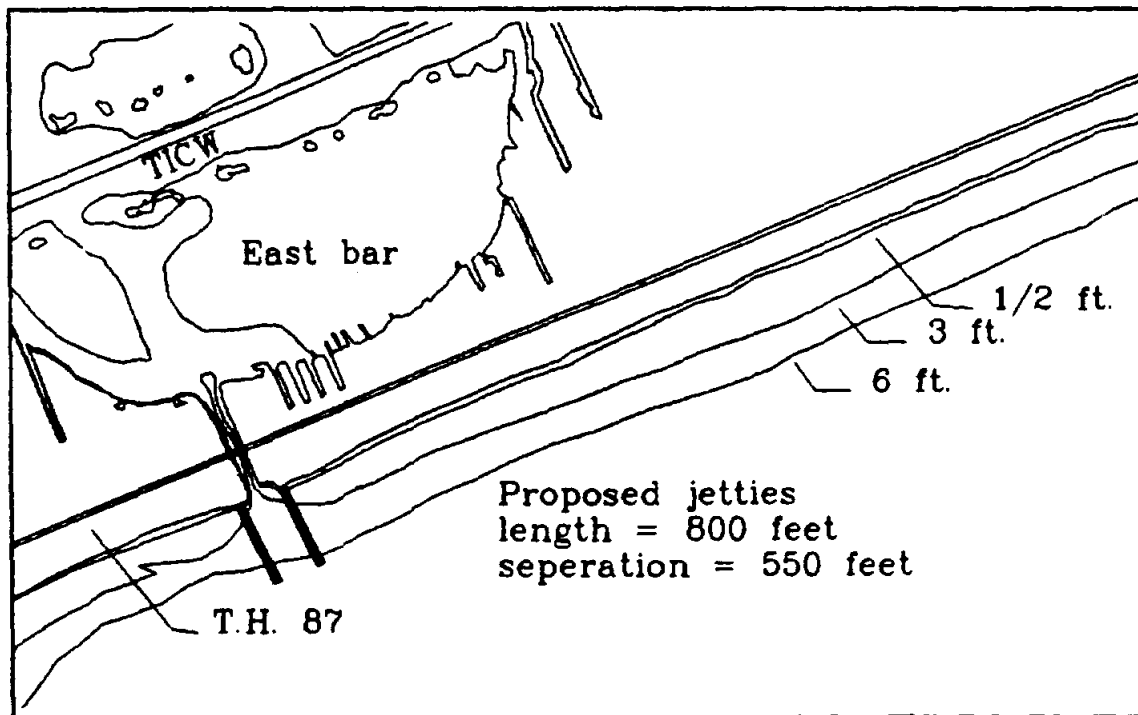

Figure 16 Overhead View of ROP Jetty Configuration

2.3.2.2. Jetty spacing Careful consideration must be taken in determining the spacing between the two jetties. If they are too close, there is the possibility of excessive scour and the undermining of the jetty foundation. If they are too far apart, shoaling could take place between them. After surveying the ROP park, it was decided to place the jetties on the edges of the park at the beach. The distance of separation will be 550 feet on centerline of the jetties. This will enable natural wave activity to keep the channel open without any danger to the jetty foundations.

### 2.3.3. Stability of the rubble-mound jetty

2.3.3.1 Design wave selection The wave data accumulated for the ROP area was instrumental in determining the design wave height as well as the jetty lengths and the armor stone unit size. The design wave height used for this design is the average of the highest one-third of all waves, or  $H_{1/3}$  as discussed in Section 2.2. The actual value was determined to be a 8.9 foot wave.

2.3.3.2. Selection of stability coefficient The stability coefficient is a dimensionless number that represents all variables having to do with the jetty except the structure slope, wave height and the specific gravity of water. Using Table 4-2 from chapter 4 of the Design of Breakwaters and Jetties, U. S. Army



Corps of Engineers, the coefficient used was chosen. This factor takes into account the number of armor layers, the type of wave, the part of the jetty, and the manner of armor layer placement. From the table, 2.0 is the lowest value for this particular design. This number was used because it will give the most conservative value when used in the Hudson stability equation.

2.3.3.3. Unit weight calculation of armor units Using the Hudson Stability equation, as shown in the Shore Protection Manual (SPM), a granite armor stone unit weight was determined to be 8640 pounds. This figure is derived by assuming the unit weight of cover stone to be 160 pounds per cubic foot, a stability coefficient of 2.0 for the head and trunk, and a design wave of 9 feet. Cover stones ranging in size from 4 to 6 tons each were chosen. These stones were also found to be satisfactory from breaking waves under normal tide conditions.

#### 2.3.4. Design of Structure cross-section

2.3.4.1. Crest elevation and width The crest elevation will be 6 feet above MLW from the beach to the end of the jetty. This is due to the limiting factor of the ROP park and its status as a washover spot in the case of a hurricane. This will also provide easy access to many of ROP fishermen.

The crest width was determined using the methods of the SPM and was determined to be 11.5 feet. Taking into account the width of three cover stones, a width of 12.5 feet was accepted. This will also allow the jetty to be constructed using land based construction equipment.

2.3.4.2. Concrete or asphalt cap Due to cost, neither a asphalt nor concrete cap will be used in the design. However, if it becomes necessary to install one in the future it can easily be done.

2.3.4.3. Thickness of cover layer For stability, a minimum cover layer thickness is calculated using the SPM. This value depends on the size of a unit cover stone and numbers of layer. Using one layer and a unit cover stone weight of 8640 pounds, the minimum cover layer was seen to be 3.7 feet. This is not a problem with the size of cover stone chosen.

2.3.4.4. Bottom elevation of primary cover layer In the SPM it is stated that "if the depth is less than 1.5 times the design wave height then the armor units shall go all the way to the bottom." Considering a depth of 8 feet at the outer end of the jetty, and a design wave of 9 feet, the armor units will go all the way to the bottom and onto the bedding layer.

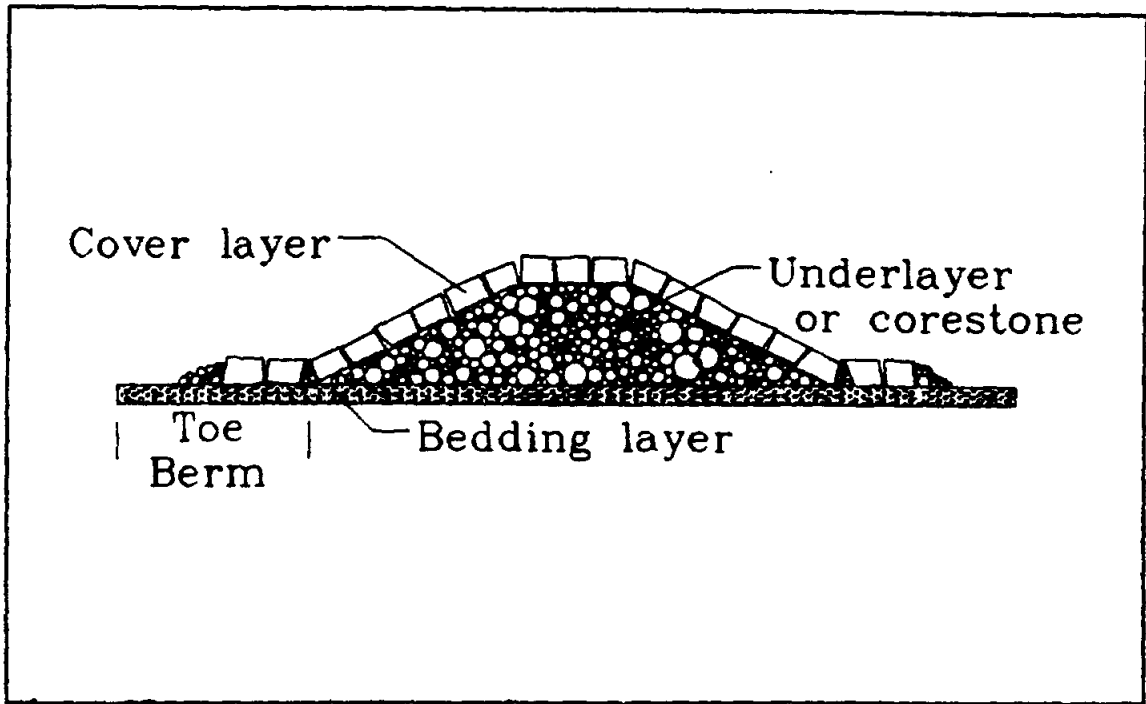

Figure 17 Jetty cross-section

2.3.4.5. Toe berm for cover layer stability As mentioned in the preceding paragraph, cover stones will be placed on the bedding layer next to the cover layer stones on the side slope. This will ensure stability of the structure against breaking waves. This berm will extend approximately 5 to 6 feet out from the side slope or the width of two cover stones. Any voids between the cover stone on the slope and the stone on the toe berm will be filled with core materials. Also, core material will be placed on the outside of the cover layer units to protect against scour.

2.3.4.6. Structure head and lee side cover layer Since the jetties are exposed to wave action on both side of the structure, cover stone will be used on both sides. The head, or outer end,

will be armored in the same manner, but will be constructed as a semi-circle. This is much the same as existing rubble-mound structures in Galveston.

2.3.4.7. Secondary cover layers and underlayers The armor layer of granite coverstone will eliminate the need for a secondary coverlayer. The cover stones will be carefully placed to form an interlocking mass of stone with a minimum of voids. The underlayer, or core, will consist of stones reasonably well graded from 200 to 1000 pounds. This core stone will be placed on top of the bedding layer and any voids will be filled with 1/4 to 4 inch filler stone.

2.3.4.8. Bedding layer and filter blanket layer The main purpose of the bedding layer is to give the structure a solid, level foundation. Using a well graded stone blanket from 2 inches to 200 pounds all the irregularities in the bottom are compromised. This blanket will extend 5 to 6 feet beyond the cover layer berm.

Geotextiles were considered, but decided against due to the high cost and the success of similar structures in the area that do not incorporate geotextiles. Being that the field of geotextiles is still very young, it is the view of the designers that geotextile use is still very much trial and error.

2.3.4.9. Scour protection at toe Most of the scour exists when the waves rush back down the structure. This force would undermine the structure after time except that the extension of the bedding layer past the cover layer toe berm prevents this.

2.3.4.10. Toe berm for foundation stability The extended toe berm provides excellent protection against scour. This, in turn, provides sufficient protection of the structure foundation.

#### 2.4.5. Stability of rubble foundations and toe protection

Calculated bearing loads on the bottom under the structure were 1000 pounds per square foot, or 7 pounds per square inch. The foundation design is designed with this taken into account. The stability of the rubble foundation depends ultimately on the sand and other material below it. From what has been observed at other similar structures, it is believed that the foundation, the toe protection, and the structure itself are stable against all factors.

#### 2.3.6. Cost-benefit analysis

The only drawback of this method of construction is the cost. As shown in Figure 2 the material cost come to just under two million dollars alone. However, when the cost is averaged out over the design life of 100 years, then the annual cost is only 38 to 40

Cover layer	44,000 tons	\$ 1,100,000
Core stone	22,000 tons	\$ 400,000
Blanket stone	17,000 tons	\$ 309,000
Filler stone	7,000 tons	\$ 136,000
Equipment and labor		\$ 1,000,000
Contingencies		\$ 500,000
Engineering and design		\$ 100,000
Administration and supervision		\$ 300,000
TOTAL =		\$ 3,845,000

**Figure 18 Cost Analysis**

thousand dollars a year. This also includes yearly maintenance cost which ranges from a few thousand dollars to nothing at all. A major benefit of these jetties is that, in conjunction with sand bypassing and beach renourishment, the jetties will help to stabilize and prevent erosion along the Bolivar peninsula. Also, in a recreational sense, jetty fishing will become a major drawing point for tourists.

### 2.3.7. Conclusion and recommendations

The hydraulic factors analysis generated the wave and current data needed to define the ROP erosion process and the conditions in which our jetties must work. The data was then incorporated in the structural design helping to derive the jetty lengths and material sizes. The jetties, as designed, should stop most of the sediment loss into the bay and withstand the forces developed by a 100 year storm.

**REFERENCES:**

Morton, Robert A., Shoreline Changes Between Sabine Pass and Bolivar Roads - Geological Circular 75-6; Bureau of Economic Geology, University of Texas, Austin, Texas, 1975.

Mathewson, Christopher C., Engineering Geology, Charles E. Merrill Publishing Company, Columbus, Ohio, 1981.

Bales, Jerald D. and Holley, Edward R., Sand Transport in Texas Tidal Inlet; Journal of Waterway, Port, Coastal, and Ocean Engineering, Vol. 115, No. 4, July, 1989. ASCE

Dean, Robert G. and Dalrymple, Robert A., Water Wave Mechanics for Engineers and Scientists, Prentice Hall, Englewood Cliffs, New Jersey. 1984.

Weggel. J. R., Weir Sand Bypassing Systems, Special Report No. 8, April 1981. U. S. Army Coastal Engineering Research Center, CE, Fort Belvoir, Va. 1981.

Prather, S. H., and Sorensen, R. M., A field investigation of Rollover fish pass, Bolivar Peninsula, Texas: Texas A&M Univ., TAMU-SG-72-202

U.S. Army Corps of Engineers, Rehabilitation of Galveston Groins; Design Memorandum No. 7. Galveston, Texas: Corps of Engineers, 1967.)

U.S. Army Corps of Engineers, Hurricane Wave Statistics for the Gulf of Mexico; Tech. Memorandum No. 98.: Corps of Engineers, 1957.

Carver and Heimbaugh, Stability of Stone and Dolos Armored Rubble Mound Breakwater heads Subjected to Breaking and Nonbreaking Waves with No Overtopping.: Corps of Engineers, 1989.

Markle, Dennis G., Stability of Rubble-Mound Breakwater and Jetty Toes.; Survey of Field Experience.: Department of the Army, U.S. Corps of Engineers, 1986.

Carver and Wright, Stability Response of Stone and Dolos Armored, Rubble-Mound Breakwater Trunks Subjected to Spectral Waves.: Department of the Army, USACOE, 1989.

U.S. Army Corps of Engineers, Shore Protection Manual, Vol. I & II: Department of the Army, U.S. Corps of Engineers, 1984.

Wiegel, Robert L., Oceanographical Engineering.: Prentice Hall, Englewood Cliffs, N.J., 1964.



Dawson, Thomas H., Offshore Structural Engineering.:  
Prentice Hall, N.J., 1983.

U.S. Army Corps of Engineers, Design of Breakwaters and  
Jetties.: Department of the Army, U.S. Corps of Engineers,  
1986.

Bottin, Robert R. Jr., Case Histories of Corps Breakwater  
and Jetty Structures.: Department of the Army, U.S. Corps of  
Engineers, 1988.

U.S. Army Corps of Engineers, Durability of Steel Sheet  
Piling in Shore Structures.: Department of the Army, U.S.  
Corps of Engineers, 1952.

Moffat and Nichol, Construction Materials for Coastal  
Structures.: U.S. Army Corps of Engineers, 1983.

Bruun, Per. Port Engineering.: Gulf Publishing Co., Houston,  
Tx., 1976

SNAME. Maximum Wave Conditions for Design.: Society o Naval  
Architects and Marine Engineers, 1978.

Weggle, J.R. Coastal Structures '83.: American Society of  
Civil Engineers, N.Y. , N.Y., 1983.

Hobson, R. D., Performance of a Sand Trap Structure and  
Effects of Impounded Sediments, Channel Islands Harbor,  
California. Corps of Engineers, Fort Belvoir, Va, 1982.

Table 6.2 p. 10 Rehab Gal. groins (Surge elevations  
h100=12.9ft.) from Texas Coast Hurricane Studies for  
Galveston Area

Sig wave height for SE 8 to 15 = 3 to 5 feet (Rehab of Gal  
groins p. 9)

observed wave breaking up to 600 feet (Rehab p. 10)  
and southeast The coast lies

APPENDIX I  
Figures 1 through 15

# ROLLOVER PASS MASE 407 Project

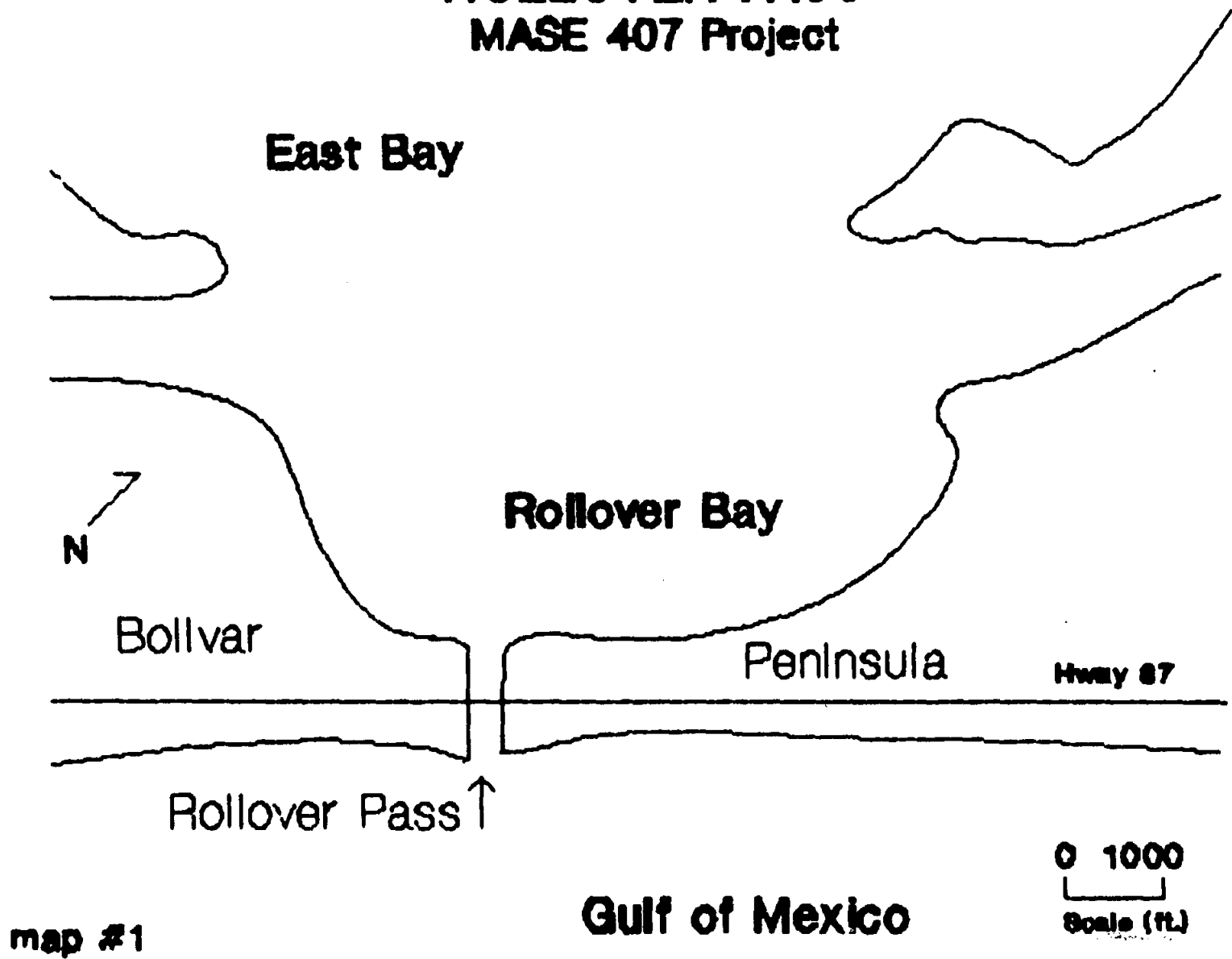

Figure 1

# ROLLOVER PASS

## MASE 407 Project

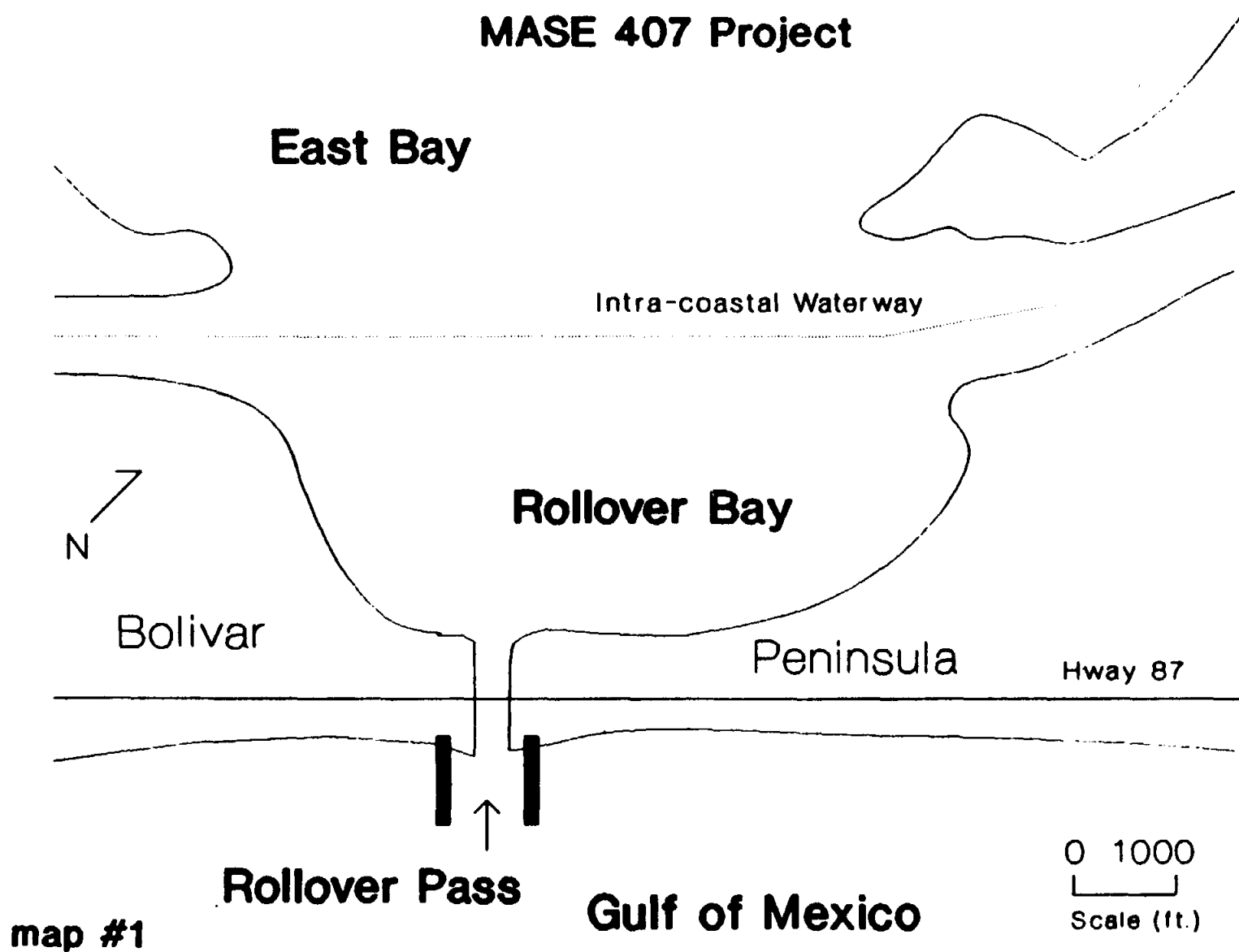
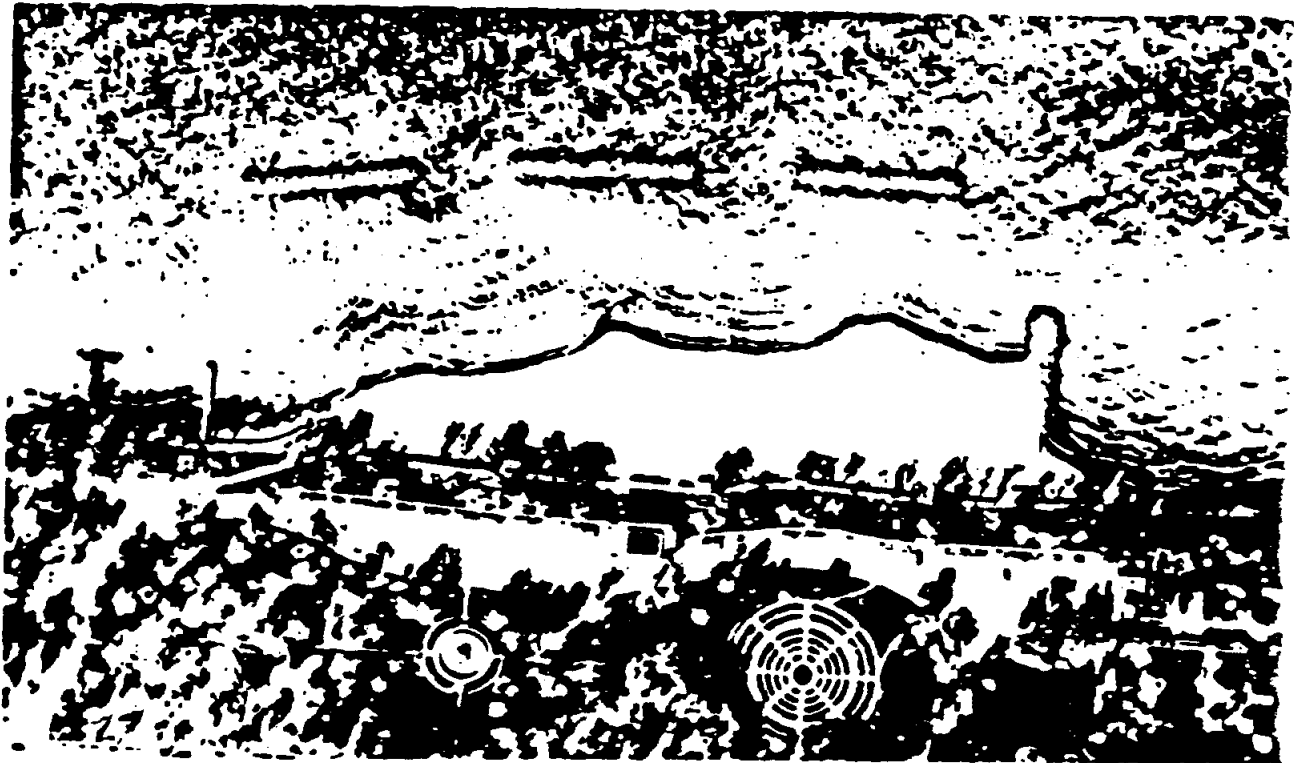

Figure 2



Lakeview Park, Lorain, Ohio (Apr. 1981)

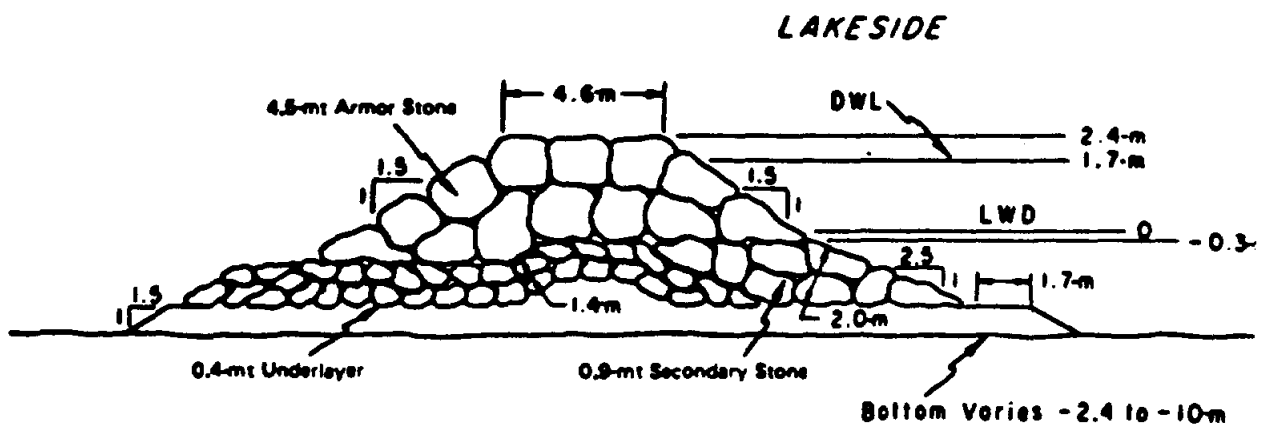
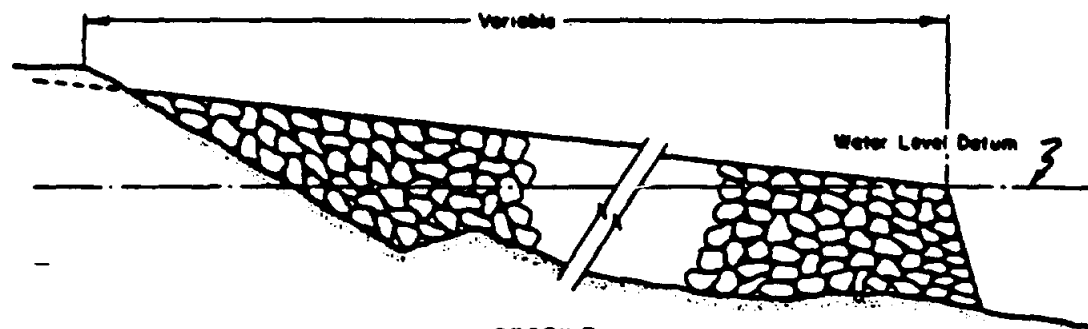

Figure 3      Segmented rubble-mound offshore breakwaters.



Westhampton Beach, New York (1972)



PROFILE

NOTE: Dimensions and details to be determined by particular site conditions

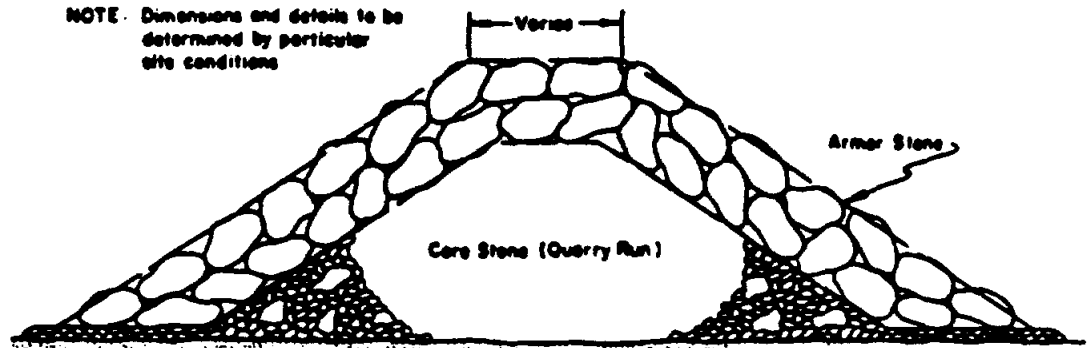

CROSS SECTION

Figure 4

Rubble-mound groin.



(Feb. 1980)

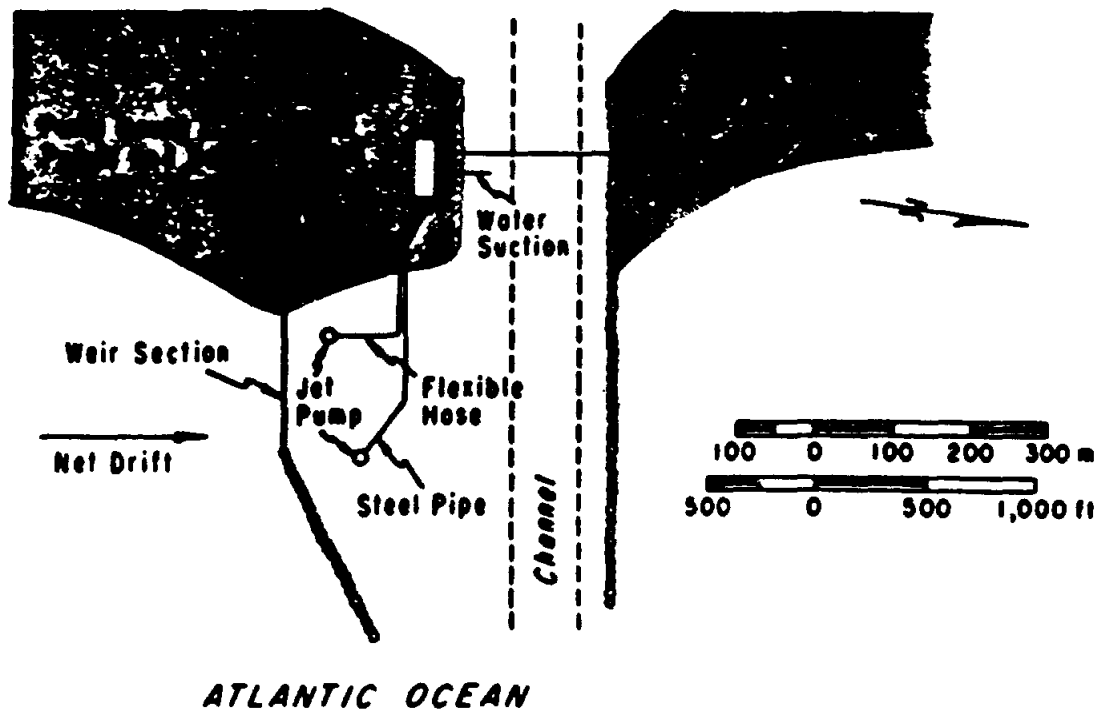
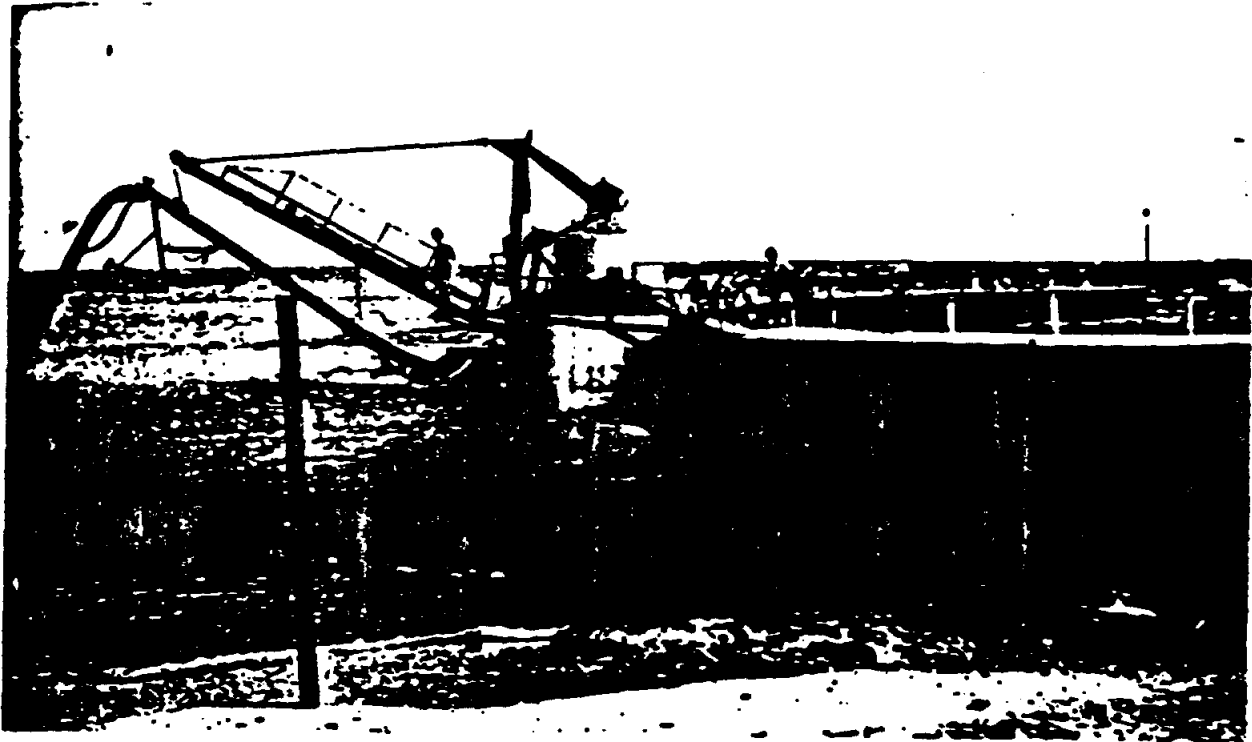

Figure 5 Fixed bypassing plant, Rudee Inlet, Virginia.



(Circa 1968)

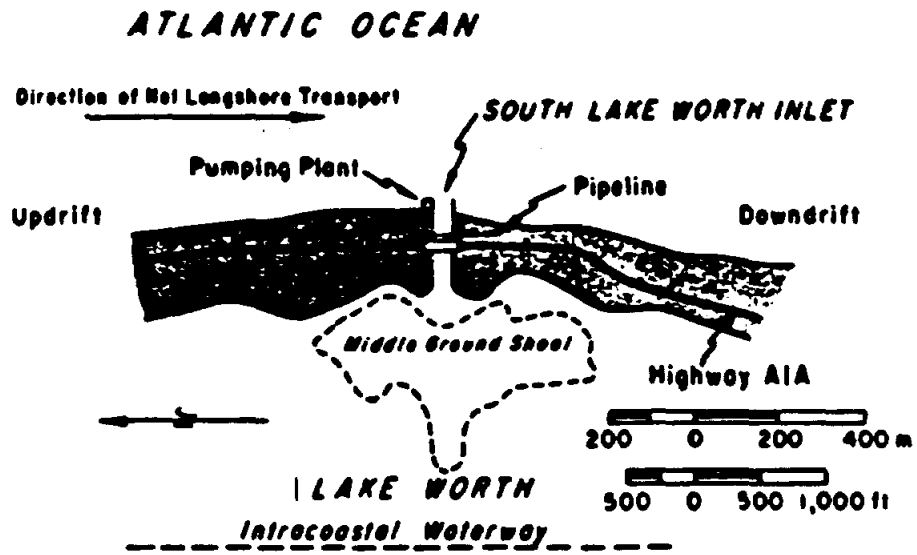

Figure 6 Fixed bypassing plant, South Lake Worth Inlet, Florida.



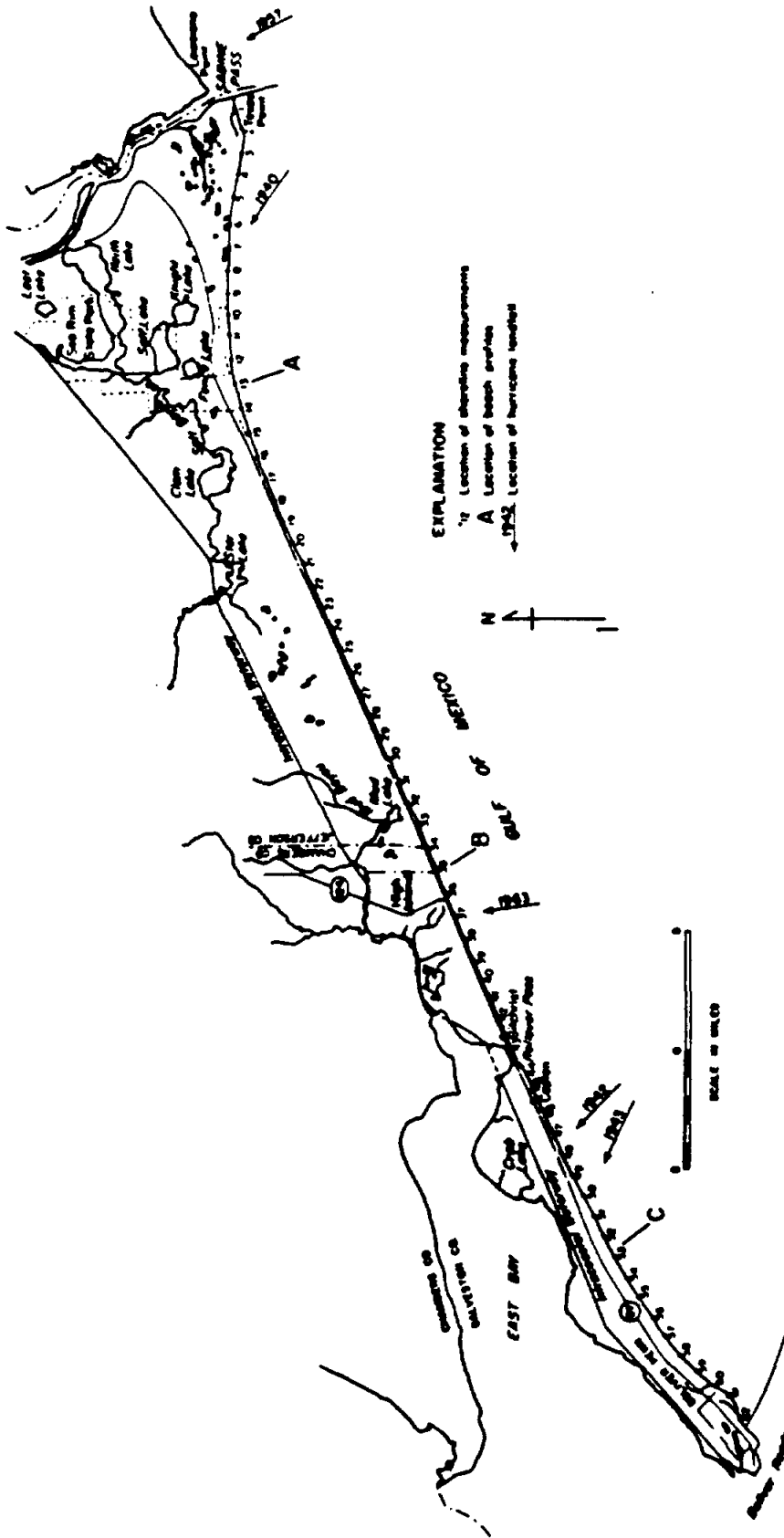

Figure 7 Location map of points of measurement and beach profiles.

# Erosion Rates for: 1882-1930, 1930-1955, 1955-1970

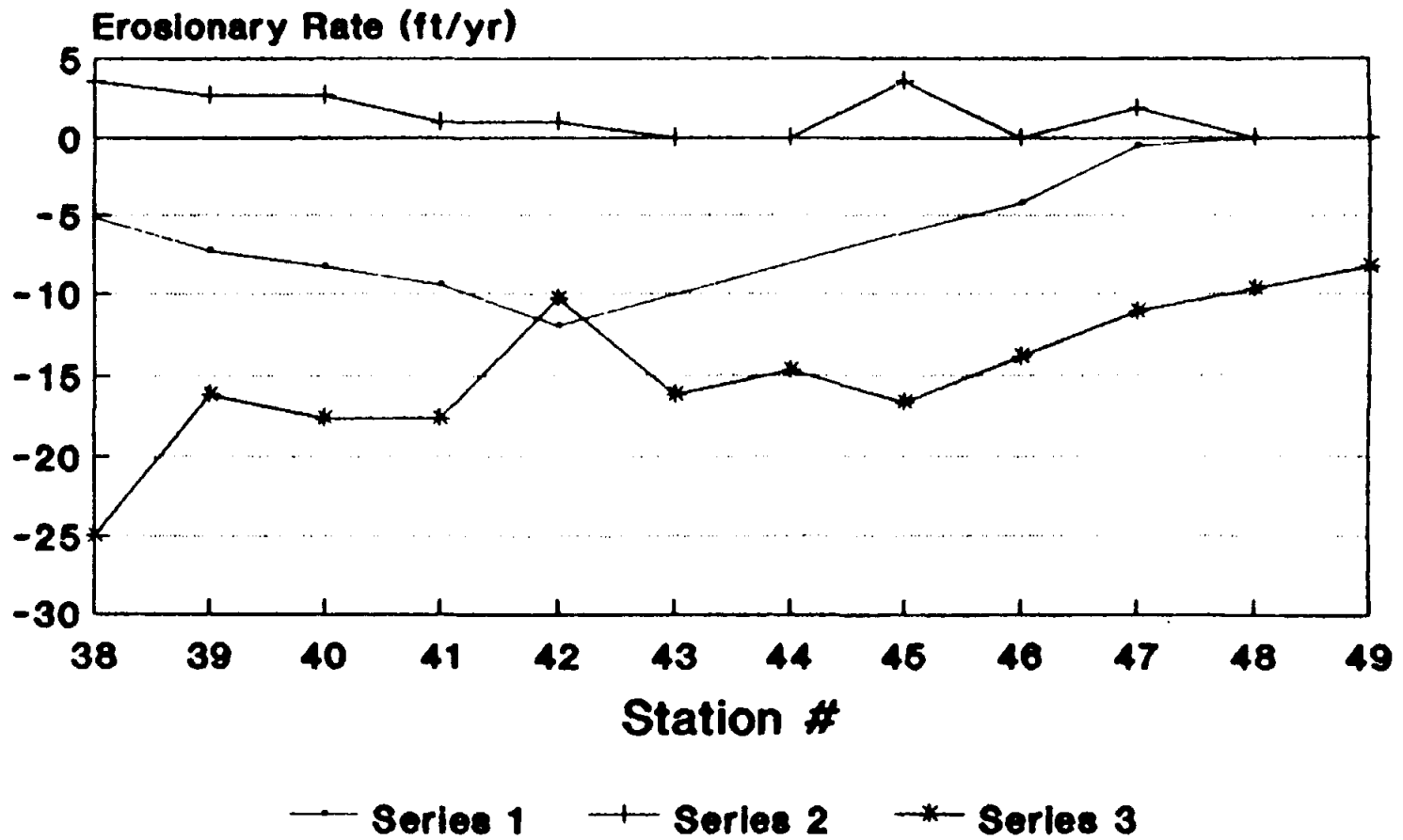

Figure 8

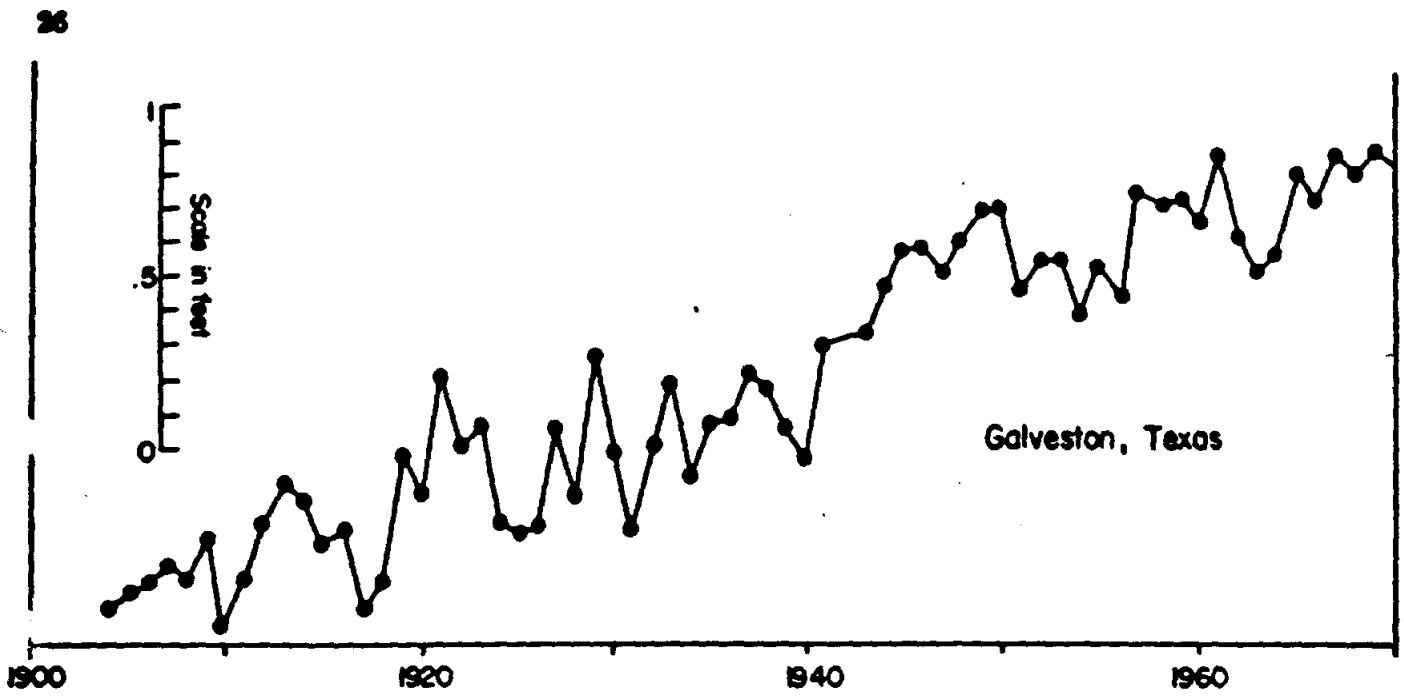
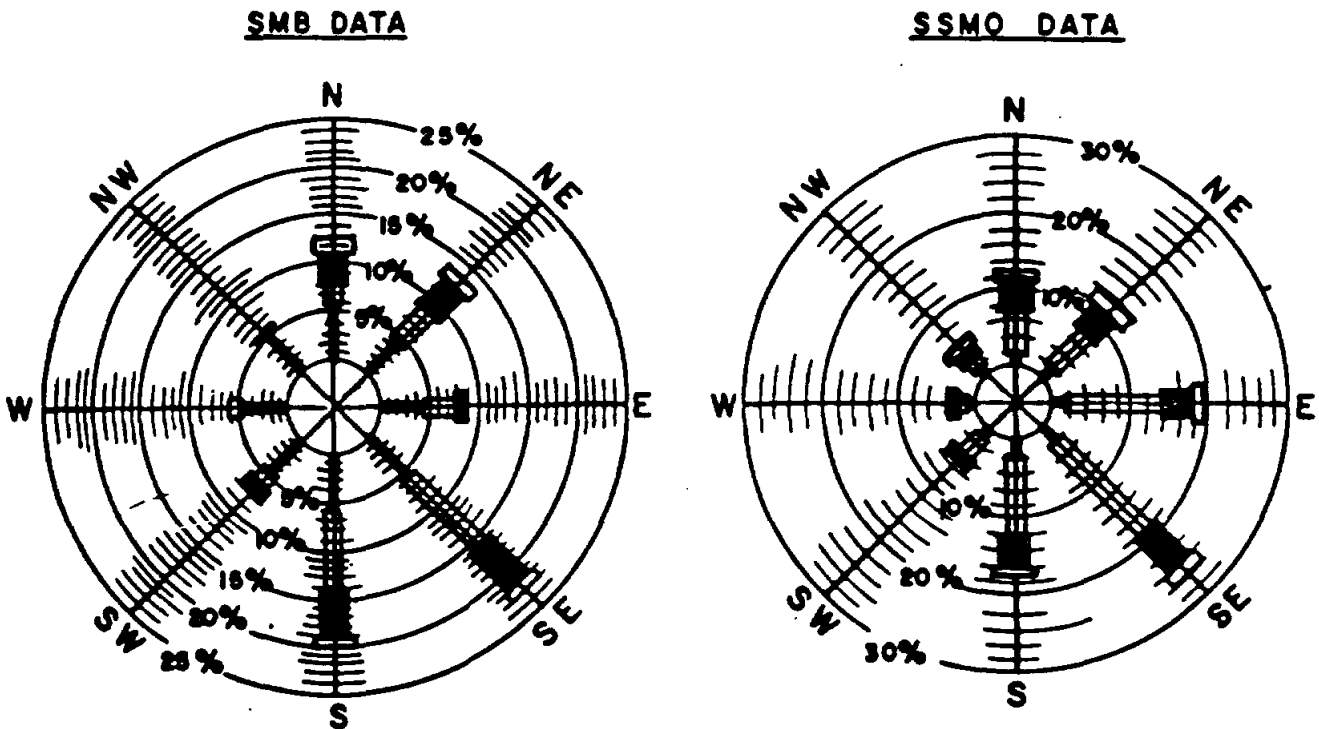

Figure 9. Relative sea-level changes based on tide gage measurements for Galveston, Texas. Data from Gutenberg (1941), Marmor (1951), and Swanson and Thudow (1978).

Figure 9

DEEP WATER WAVE HEIGHT VS WAVE DIRECTION ANNUAL



SCALE IN FEET

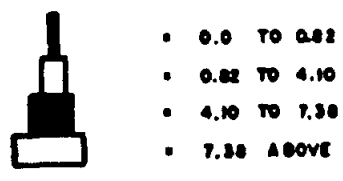

Figure 10

**WAVE STATISTICS**

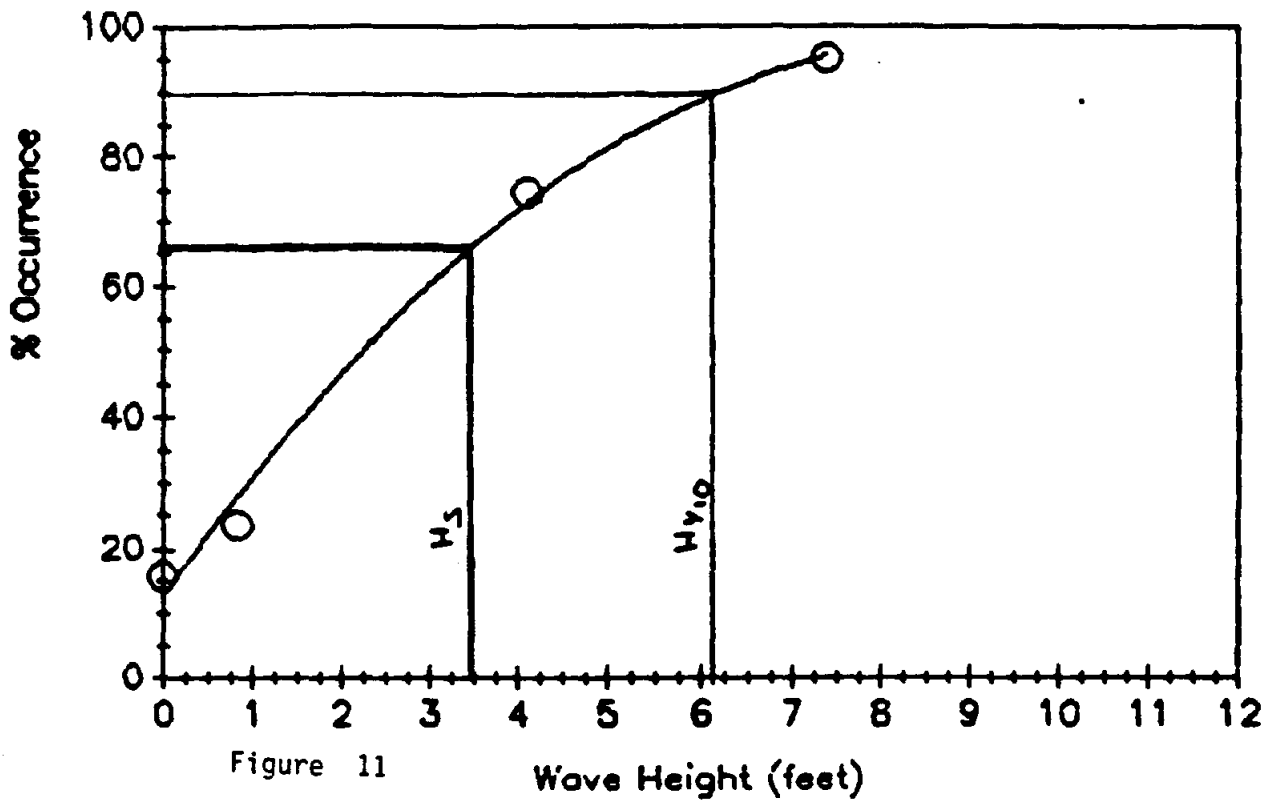
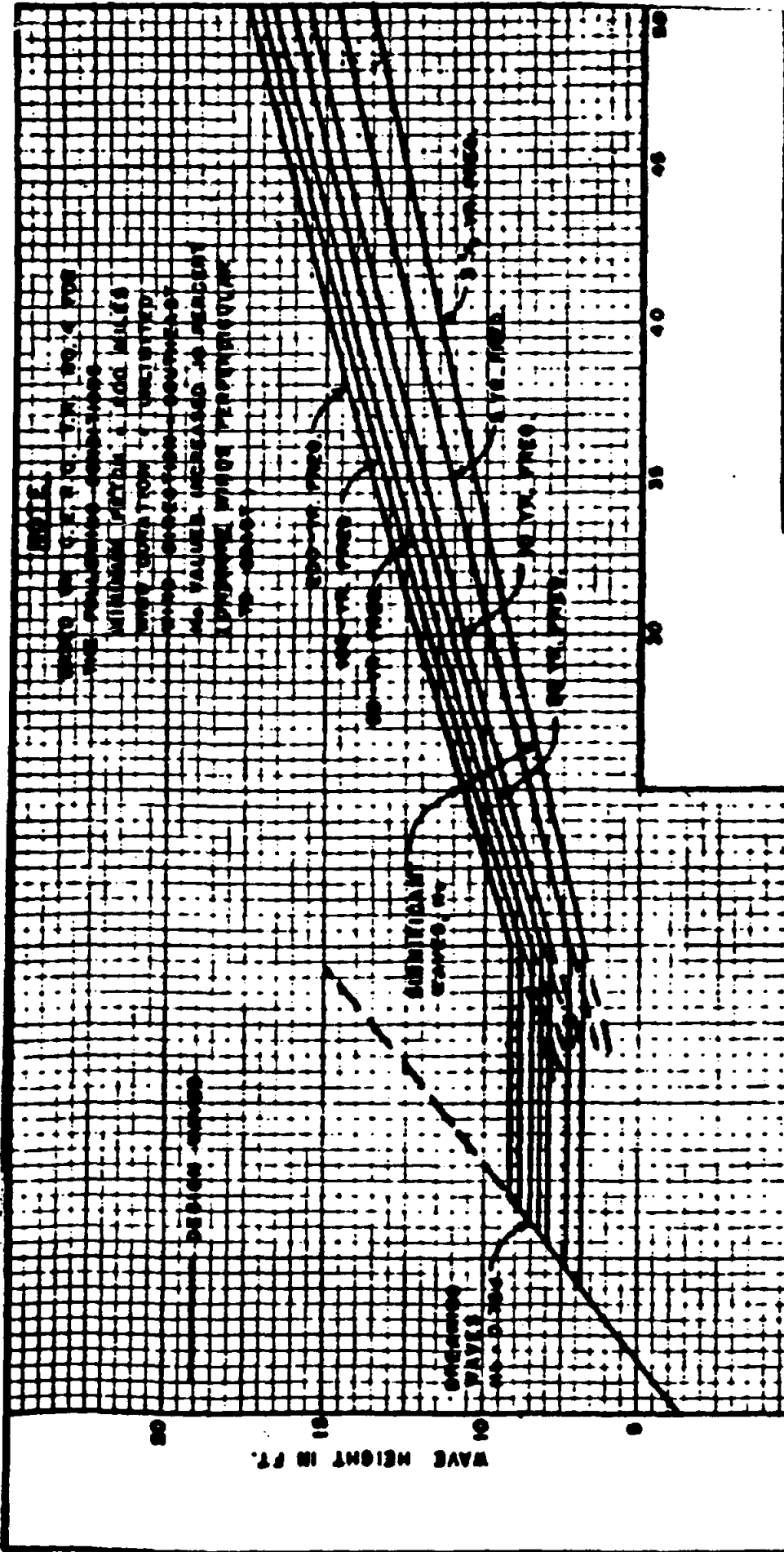

Figure 11



GALVESTON HARBOR AND CHANNEL, TEXAS

RECALCULATION OF BEACHPROFT GROUPS  
 WAVE HEIGHT  
 VS  
 WATER DEPTH

U.S. ARMY ENGINEER DISTRICT, GALVESTON, TEXAS

TO ACCOMPANY OTHER DRAWINGS NO. 7  
 DATED: MAY 1967

Figure 12

END OF DRAWING SET  
 PLATE 6

For water depth = 20 feet

$g$  = 32.2 ft/sec<sup>2</sup> = acceleration due to gravity  
 $F$  = 200 miles, minimum fetch length  
 $U$  = 101 mph = 148 feet/sec, sustained wind velocity, the southeast (100-yr frequency)

$d$  = 20 feet

$H_s$  = significant wave height in feet

$$\frac{gF}{U^2} = \frac{32.2 \times 1,056,000}{148 \times 148} = 1550$$

$$\frac{gd}{U^2} = \frac{32.2 \times 20}{148 \times 148} = 0.0293$$

$$\frac{gH_s}{U^2} = 0.012 \text{ (see fig 1-32, pp 56, TR No. 4)}$$

$$H_s = \frac{0.012 \times 148 \times 148}{32.2} = 8.1 \text{ feet}$$

Design wave = 1.1  $H_s$  = 8.9 feet (see pp 20, TM No. 84)

6.3.3 Technical Memorandum No. 84 indicates that the above procedure is unreliable for computing wave heights in depths of water less than 20 feet. Because of this limitation, the procedure was not used to compute the wave heights for depths shallower than 20 feet. In depths less than about 11.5 feet, the design wave heights for a 100-year frequency surge were assumed to equal the breaking wave heights, or about 0.78 of the water depths, which is accepted as the maximum ratio of wave height to water depth for propagation of unbroken waves in shallow water. In the transition depths ranging from 11.5 to 20 feet, neither method is fully reliable. However, for design purposes, the wave heights computed for the 20-foot depth were applied throughout this transition range. Wave heights for other frequency surge elevations were determined in a similar manner.

6.3.4 The design wave heights based on computations and procedures described above for various depths and frequencies are shown on plate 8.

## VI STORM SURGE AND WAVE CHARACTERISTICS

6.1 General. - The hydrology and hydraulic data which provide a basis of design were developed in the Texas Coast Hurricane Studies for the Galveston area.

6.2 Design surge. - The design surge used for wave height computations is 12.9 feet above mean sea level. Its expected frequency of occurrence is once in about 100 years. This surge is slightly less than those computed by less refined methods using the same central pressure index. Surge elevations that may be expected to occur for various frequencies are presented below:

<u>Years between events</u>	<u>Frequency events/100 yr</u>	<u>Elevation ft, msl</u>
200	0.5	11.4
100	1.0	12.9
50	2.0	12.6
20	5.0	9.4
10	10.0	6.9
5	20.0	4.5
3-1/3	30.0	3.6
1	100.0	2.4

6.3 Design wave heights. - The wave heights used in the design were determined by techniques presented in Coastal Engineering Research Center Technical Report No. 4 and in Beach Erosion Board (now Coastal Engineering Research Center) Technical Memorandum No. 84.

6.3.1 The assumed wind direction from the southeast is approximately perpendicular to the shore line and offshore contours. Waves from that direction are therefore not significantly reduced by refraction.

6.3.2 The following computations illustrate the method given in the above referenced publications as used to determine the height of significant waves generated in the Gulf of Mexico at Galveston, Texas. With the surge heights indicated above, the maximum water depths at the outer ends of the groins would be on the order of 20 feet, while depths at the inner ends would approximate the surge heights. Accordingly, wave heights were computed within this range of depths by the following methods:



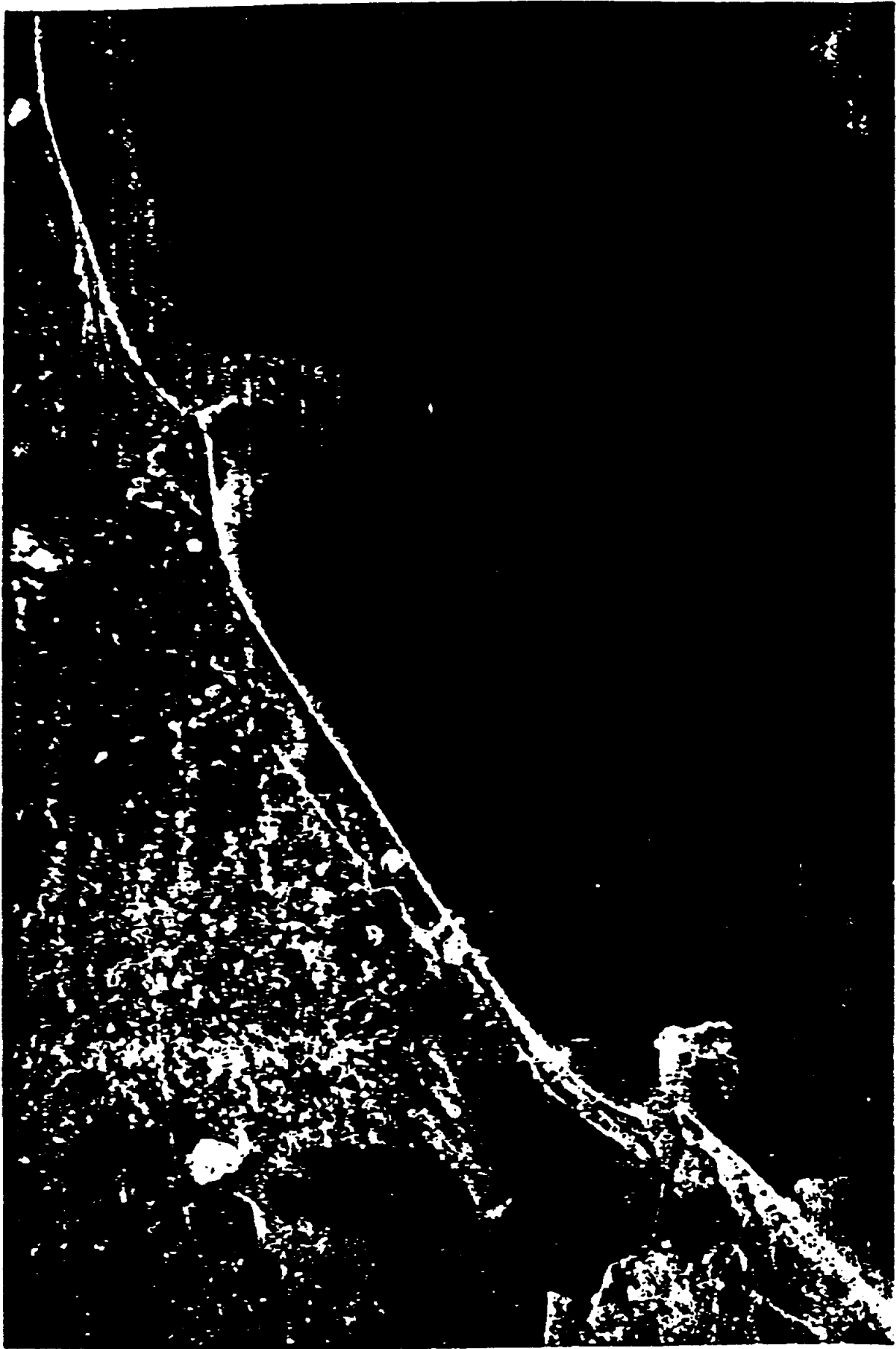

Figure 15 Littoral drift along upper Texas Coast (Bobbins Pass-Oakvaton Island). Reproduction from NASA ERTS E-1180-16194-401, January 1979.

APPENDIX II  
Calculations

# Unit weight calculation of armor units

Using Hudson Stability Equation

$$W_a = \frac{\gamma_a H^3}{K_D (S_c - 1)^3 \cot \alpha}$$

where

$W_a$  = unit wt. of individual armor units in lb.

$\gamma_a$  = Unit wt. = 160 lb/ft<sup>3</sup>

$H$  = design wave = 9.0 ft

$K_D$  = stability coefficient From Table D.8 (SPM) = 2.0

$S_c$  = specific gravity =  $\frac{\gamma_a}{\gamma_w} = \frac{160}{64} = 2.5$

$\cot \alpha$  = slope = 2

$$W_a = \frac{160 (9)^3}{2 (2.5 - 1)^3 (2)} = 9640 \text{ pounds}$$

Crest width

$$B = n k_D \left[ \frac{W}{W_r} \right]^{1/3}$$

where

$B$  = crestwidth, ft

$n$  = number of stones ( $n=3$  is recommended

$k_D$  = layer coefficient (Table 7-13) SPM  
minimum)

$W$  = mass of armor unit in primary cover  
layer lb

$W_r$  = mass density of armor unit lb/ft<sup>3</sup>

$$3(1) \left[ \frac{8640}{160} \right]^{1/3} = 11.2 \text{ ft}$$

## Layer Thickness

Armor Unit Layer

$$r = n k_{\Delta} \left( \frac{W}{W_r} \right)^{1/3}$$

$$r = 1(1) \left( \frac{8640}{160} \right)^{1/3} = 3.7 \text{ ft}$$

First Underlayer

$$r = 1(1) \left( \frac{864}{160} \right)^{1/3} = 1.7 \text{ ft}$$

COST ANALYSIS OF MATERIALS

TYPE	SIZE	COST	W/FREIGHT
(1) COVER STONE (GRANITE)	6-8 tons	\$25/ton <sup>*1</sup>	TRUCK
	8-10 tons		
	10-12 tons		
	12-14 tons		
	14-16 tons		
	16-18 tons		
	(2) CORE STONE	200-1000 lbs	\$6/ton <sup>*2</sup>
200-2000 lbs			
200-4000 lbs			
(3) FILLER STONE	1/2"-2" DIA	\$4.50/ton <sup>*2</sup>	TRUCK \$19.50/ton
(4) BLANKET STONE	1/2"-200 lbs		BARGE \$17/ton <sup>*2</sup>
(5) RIP-RAP (LIMESTONE)	6"-12" DIA	\$6.00/ton <sup>*2</sup>	RAIL \$19.50/ton
	6"-24" DIA	\$10.0/ton <sup>*3</sup>	TRUCK \$23.50/ton

- 
1. TEXAS GRANITE CORPORATION, NEW BRAUNFELS, TEXAS
  2. SURTEX MATERIALS COMPANY, NEW BRAUNFELS, TEXAS
  3. McDONALD BROS., NEW BRAUNFELS, TEXAS

CHAPTER 3 SAND BY-PASSINT DESIGN  
Desingers: Michael S. Vichers & William J. Hoffman

TABLE OF CONTENTS

ABSTRACT

3.1.	INTRODUCTION .....	1
3.1.1	Project Description .....	1
3.1.2	Review of Sand By-passing System.....	1
3.2.	CHARACTERISTICS OF THE LITTORAL REGIME NEAR ROLLOVER .....	5
3.3.	VOLUME AND FREQUENCY OF SAND BY-PASSING OPERATION .....	7
3.4.	PRELIMINARY DESIGNS .....	8
3.4.1	Design A: Dragline System .....	8
3.4.2	Design B: Pump Station System .....	13
3.4.3	Cost Benefit Analysis .....	19
3.4.4	Selection Between Alternative Designs .....	20
3.4.5	Bibliography .....	21
3.4.6	Work Consulted .....	21

**ABSTRACT**

When a coastal project interrupts the littoral transport of sand and sediments along a coastline, a sand by-passing system can be incorporated into the project to aid in the redirection of the littoral transport in such a way as to by-pass the obstruction. For the projected construction of two parallel jetties at Rollover Pass, a sand by-passing system was recommended to help redistribute the sand trapped by the to nearby eroding beaches. This report contains the information and designs for two different sand by-passing systems which could be utilized for the Jetty project.



## CHAPTER 3. SAND BY-PASS DESIGN

### 3.1. INTRODUCTION

#### 3.1.1. PROJECT DESCRIPTION

The proposed construction of two parallel jetties at Rollover Pass will alter the sediment flow through the pass as well as along the coast in order to create a more favorable sediment distribution. This alteration will create a zone of accretion just to the North-East of the north Jetty, as seen figure 3.1, while likewise creating an erosion state South-West of the Jetty system. In order to balance the accretion/erosion states on either side of Rollover Pass, a sand by-pass system can be utilized. Sand by-passing is the hydraulic or mechanical movement of sand from the accretion (up-drift) side to the eroding (down-drift) side of an inlet or harbor entrance. The nourishment of the down drift beaches, by sand by-passing, can be accomplished by placing the by-passed sand all along the eroded beach or by creating a feeder beach. A feeder beach is an artificially widened beach serving to nourish down drift beaches [1:5-57]. A feeder beach for the Rollover pass area will be described later.

#### 3.1.2. REVIEW OF SAND BY-PASS SYSTEMS

The subject of sand by-passing is not a new concept. In fact, the by-passing of inlets and waterways has been occurring naturally since the creation of the earth. This

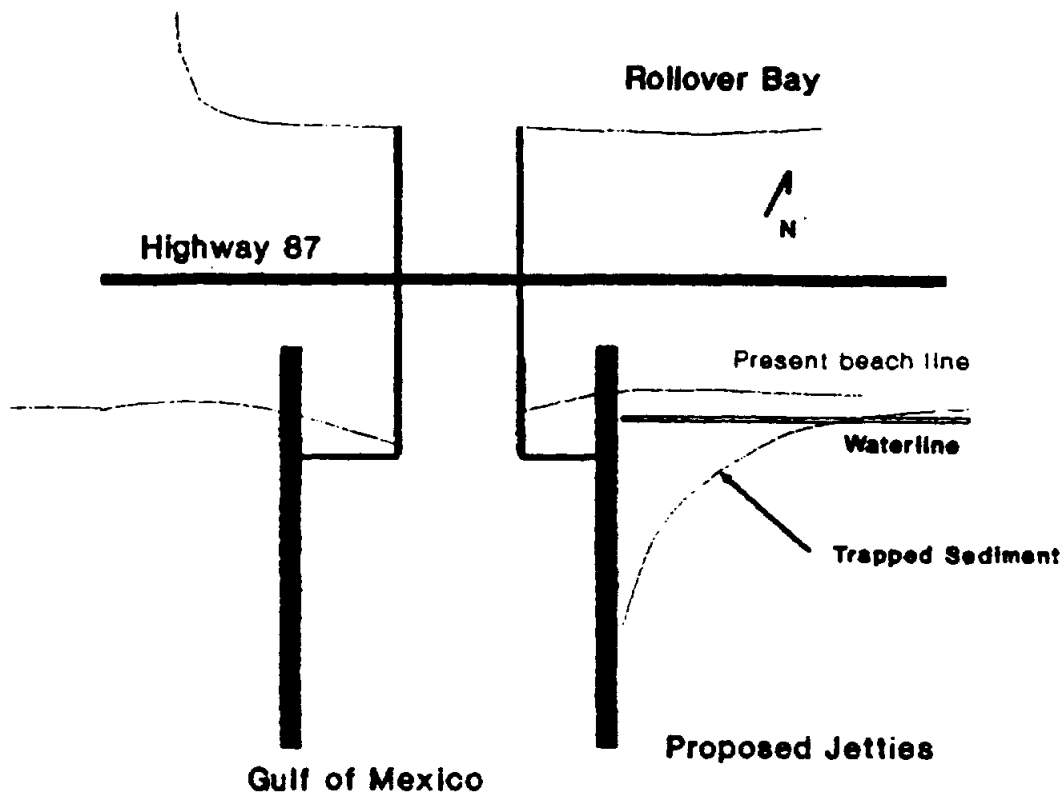

Figure 3.1: Jetty Sand Trapping

natural by-passing is typically accomplished by sand bars which allow the passage of sand and other sediments along the seaward side of the particular barrier, as shown in figure 3.2, by-passing the inlet. Because the sediment is restrained by the barrier, it cannot be drawn into the inlet and deposited inshore which reduces the amount of sediment available to nourish the beaches further down the coast.

Sand by-passing can also be accomplished by man made or mechanical means, either by physical barrier (i.e. man made

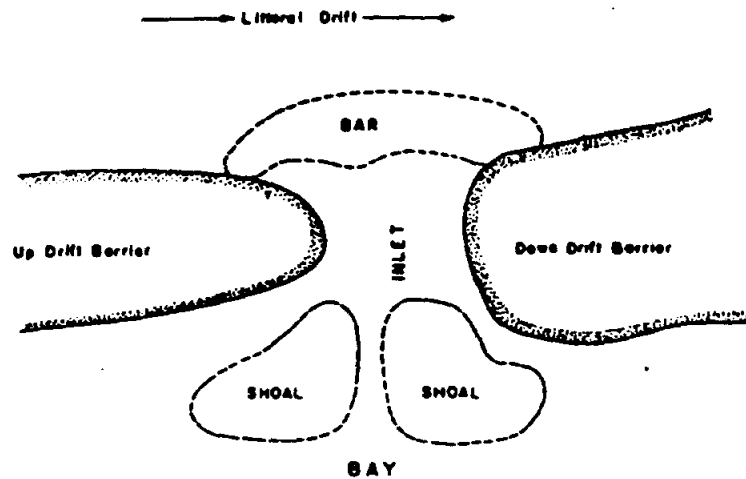

Figure 3.2: Natural Sand By-passing via Sand Bar [2:376]

groins etc.) or mechanically removing the sand by physical displacement. The physical displacement methods vary from physically removing the sediment to dynamically pumping the sediment from one point to another. For the Rollover Pass project, five different type of sand by-passing systems were initially considered. First was a floating dredge system. It was discounted because of the limited draft at Rollover Pass and the excessive wave action. Second was the weir system which can be seen in figure 3.3. It was discounted because the system is designed to trap sand inside the jetties. Because of the configuration of the Rollover Pass jetties, sand would be permitted to flow into the bay which is a direct contradiction to the goal of the project. The third system considered was the fixed pump station which is

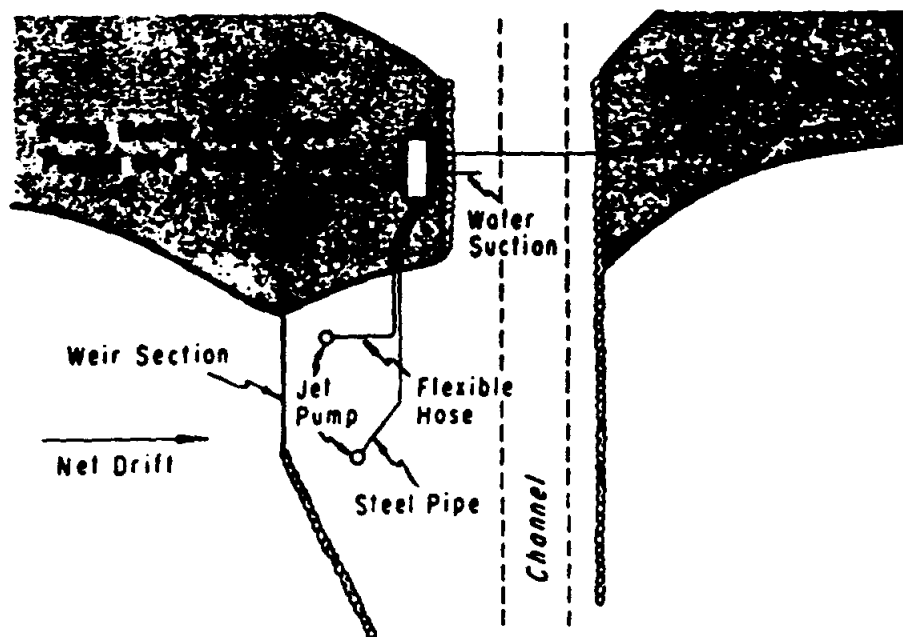

Figure 3.3: Weir System [1:6-60]

shown in figure 3.4. This type of system will be discussed in section 3.4.2. of this report. The fourth type of system to be considered is a jet pump system. Although it is relatively similar to the previously mentioned fixed pump station system it was considered infeasible because of the cost and relative complexity compared to the amount of sand that is to be by-passed. The fifth and last system to be considered was a construction type system. This system, which is discussed in section 3.4.1. of this report, utilizes construction equipment to move sand from one place to another.

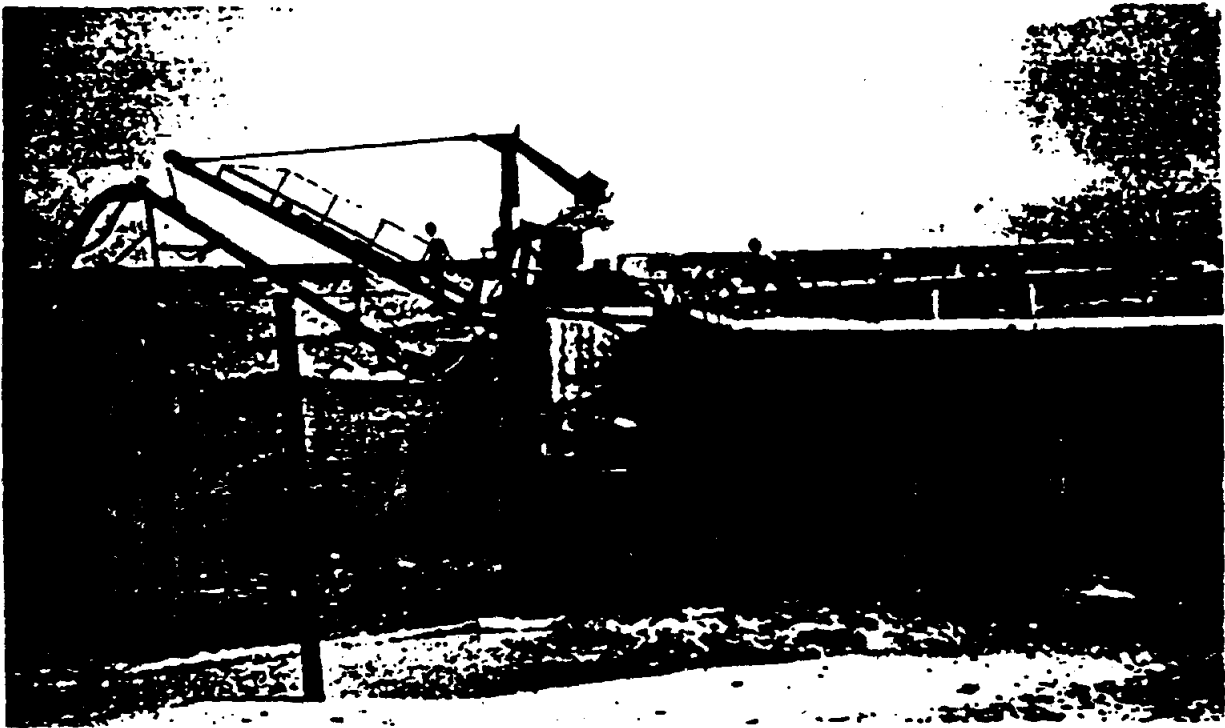
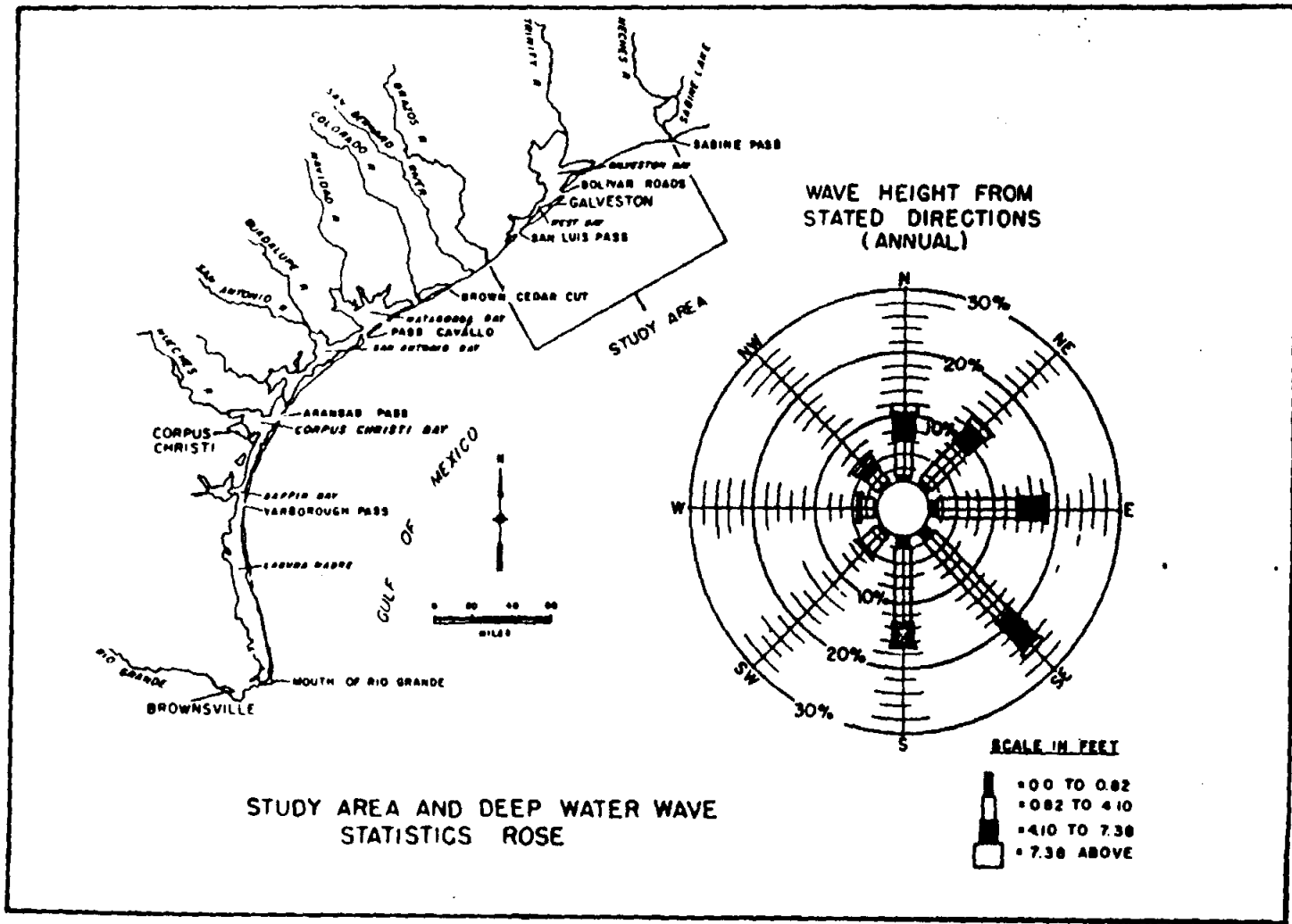

Figure 3.4: Fixed Pump Station [1:6-57]

### 3.2. CHARACTERISTICS OF THE LITTORAL REGIME NEAR ROLLOVER

Typically there is little littoral drift during most of the year. The largest deposits of sediments occur during northerlies, polar fronts, and hurricanes. Since hurricanes are infrequent and unpredictable, they are omitted from consideration for by-passing operations but are considered for equipment survivability. Therefore, the predominant event which affects the littoral drift is the northerlies. The individual factors producing the littoral flow are the wave and wind forces. As shown in figure 3.5, the wave rose diagram depicts that the wave forces are predominantly

Figure 3.5: Wave Rose Diagram [3:34]



from the East and South-East directions. Wind also plays an important part in the littoral drift. Table 3.1 shows the relationship between the wave and wind transport rates. It also establishes that a combined rate of 99,880 cubic yards of sediment flows along the coastline around Rollover Pass. From the table, the negative value determines that the predominant flow of sediment is carried by the long shore current flowing in the South-West direction.

DRIFT DUE TO WAVE:	(CUBIC YARDS)
GROSS WESTWARD (-)	-109,825
GROSS EASTWARD (+)	55,145
TOTAL GROSS	- 54,680
DRIFT DUE TO WIND GENERATED CURRENT:	
NET DRIFT	- 45,200
COMBINED NET DRIFT	- 99,880

Table 3.1: Summary of Littoral Drift Predictions for  
Rollover Fish Pass [3:24]

### 3.3. VOLUME AND FREQUENCY OF SAND BY-PASS OPERATION

The Jetties that are proposed are considered to trap 65 percent of the littoral drift. Therefore, the amount of trapped sand that must be by-passed each year is approximately 65,000 cubic yards. This estimation is based on the U.S. Corps of Engineers Shore Protection Manual, which states, "For high groins extending to a 1.2 to 3 meter (4 to

10 foot) depth below mean water level or mean lower low water level, or for groins extending to a depth more than 3 meters, use 75 percent of the total longshore transport" [1:5-39]. Considering the fact that the 75 percent littoral drift stoppage is based on the Atlantic coast, extrapolation was used to obtain a value of 65 percent for the Rollover Pass area.

The frequency of the by-passing operation is dependent on the type of by-passing system that is used. The frequency could range from twenty to one hundred days.

### 3.4. PRELIMINARY DESIGNS

#### 3.4.1. DESIGN A: DRAGLINE SYSTEM

The dragline system for sand by-passing is to consist of a dragline, bulldozer, and dump trucks. Once sand has been trapped by the north Jetty, as seen in figure 3.6, the dragline will be driven along the beach line and positioned so that it is able to reach the sand that needs to be by-passed. A dragline is similar to a crane, except it has a scoop at the end as seen in figure 3.7 [4:9-47]. The scoop is lowered and then dragged across the desired excavation area, filling the scoop. The scoop is lifted and the sand is placed in a dump truck. Once the dump truck is filled, it is driven to the south Jetty where the sand is dumped. It then returns to the dragline. The route which the dump truck follows is shown in figure 3.6. The proposed route is given in order that the dumptrucks will not interfere with each other. A



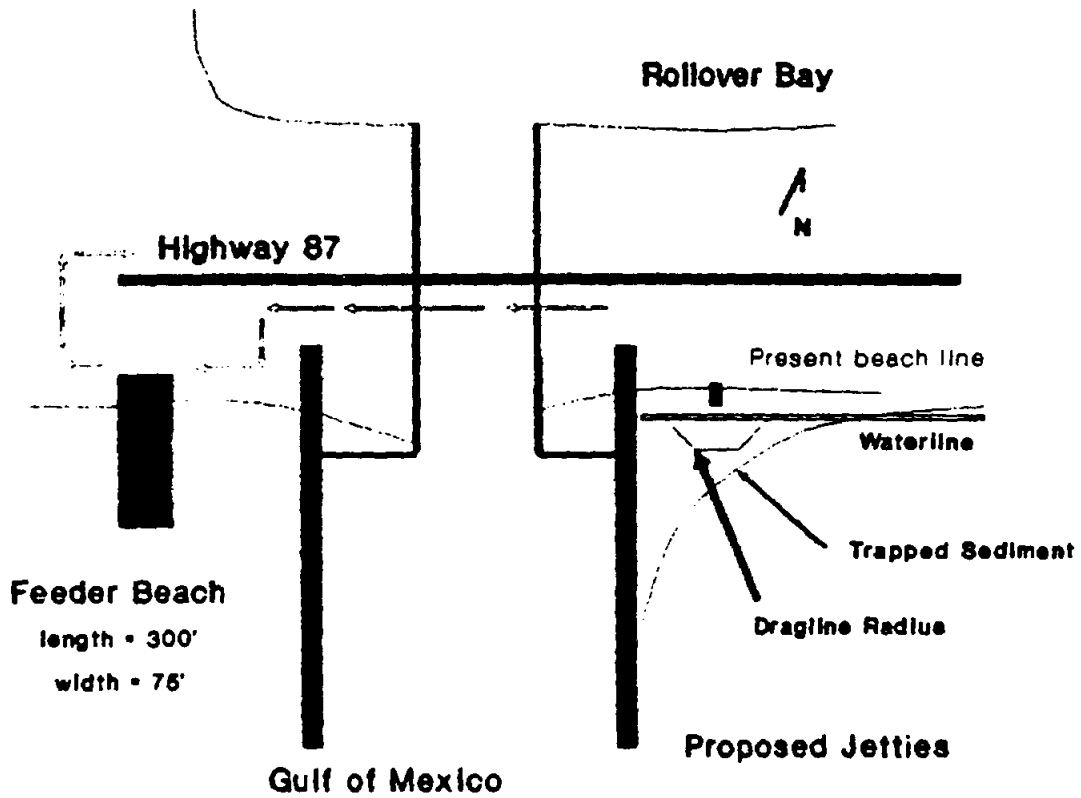

Figure 3.6: Overview of Dragline System

feeder beach is to be made by the bulldozer on the South side of Rollover Pass with the dumped material.

The dragging procedure is to be started close to the base of the north jetty as seen in figure 3.6. The area is to be excavated so that one particular spot is not made into a hole. When necessary the dragline is to move up and down

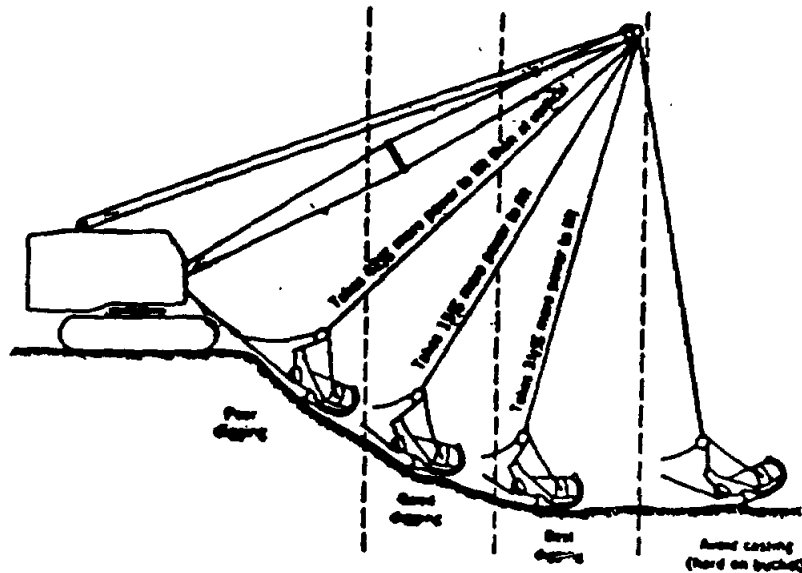

Figure 3.7: Dragline

the beach depending on how the sand is trapped. The dragline is to move 65,000 cubic yards of sand. Once the procedure has been finished, the excavated area will become relatively smooth, due to the wave action pushing sand into the low-lying areas.

The sand from the dump trucks will be used to make a feeder beach. A feeder beach is built of sand jetting out into the gulf. Its purpose is to let the sand erode naturally down to the adjacent beaches. It is less expensive and less time consuming than attempting to spread the sand out over an entire region of eroded beach. The feeder beach is to be placed 700 feet South of the south Jetty. This is to minimize it's protection by the Jetty. If it were placed

closer to the Jetty, the Jetty would act as a shelter to incoming waves. Since the incoming waves are predominantly from the East or Southeast directions as seen in the wave rose diagram, and the Jetties are placed perpendicular to the beach, the angle of incoming waves is 45 degrees. Using a simple calculation for wave defraction, the distance of the feeder beach from the Jetties is estimated at 570 feet. However, as a safety factor, the distance of the feeder beach from the Jetties is to be 700 feet, insuring that the feeder beach will properly erode. The feeder beach is 300 feet long, 75 feet wide, and 3 feet deep. It is made by the bulldozer pushing the sand seaward, each time it goes a little farther until a length of 300 feet is met. Dan Sefcik, an engineer at Hunter Construction Company, was consulted, and agreed that the process of creating a feeder in such a way is feasible [5].

The machinery consists of a type 108 Link Belt number 50 dragline, D6 bulldozer and 5 to 6 dump trucks. The number of dump trucks is based on the time to drive and unload their load and return to the loading site. The time is approximately ten minutes. This is to minimize the use of the dump trucks.

In considering the cost analysis of the dragline system, see table 3.4, several factors must be described. The cost of the dumptrucks is included in the price of the dragline but the cost of the bulldozer must be considered separately. The cost of the operators, supervisors and/or any other

liabilities incurred, such as insurance, is given in an overhead factor which is multiplied by the total cost of the equipment as seen in table 3.4. All equipment types and costs were derived from the Hunter Construction Company [5].

Due to the occurrence of hurricanes, the time requirements for by-passing operations are based on the polar fronts. Since most of the sand is trapped after storms, spring is the best time for sand by-passing. April is the chosen month, due to a high tourist season in the summer. From calculations, the total time necessary for complete sand by-passing came to 20 to 30 days as seen in table 3.2. This timetable has been confirmed by the Hunter Construction Company and the Corps of Engineers at Vicksburg, Mississippi.

AMOUNT OF SAND	=	65,000 CU.YD.
CAPACITY OF DUMP TRUCK	=	14 CU.YD.
CAPACITY OF DRAGLINE SCOOP	=	2 CU.YD.
TIME FOR 1 SCOOP PLACED IN TRUCK	=	1 - 1.25 MIN.

$\frac{\text{AMOUNT OF SAND}}{\text{CAPACITY OF DUMP TRUCK}}$	=	7 FILLS/TRUCK	=	1 SCOOP
---	---	---------------	---	---------

FOR:	1 MIN.	=	22 DAYS
	1.25 MIN.	=	28 DAYS

Table 3.2: Dragline Time Requirements

The use of highway 87 is limited to 80,000 pounds per vehicle. The weight of the dragline is the only piece of machinery which exceeds the limit of highway 87, as seen in table 3.3. Therefore a permit must be attained in order to exceed the weight limit. This is to be done by applying for a permit at the Texas Highway Department in Houston. Other legal aspects may occur in the event that this proposal is actually carried out, however, due to the scope of this *chapter* (report), they will not be mentioned.

DRAGLINE	=	82,000 lb.
DUMP TRUCK	=	48,000 lb.
BULLDOZER	=	32,000 lb.

Table 3.3: Equipment Weights for Transport

#### 3.4.2. DESIGN B: PUMP STATION SYSTEM

The pump station system is designed as a fixed station for the dredging of sand sediment from around the north-east Jetty at Rollover Pass. The pump station is located 240 feet from the projected beach line (see figure 3.8). The base of the station is of reinforced concrete construction placed on a set of driven piles for vertical stability (see figure 3.9). The base is built into the Jetty structure to add

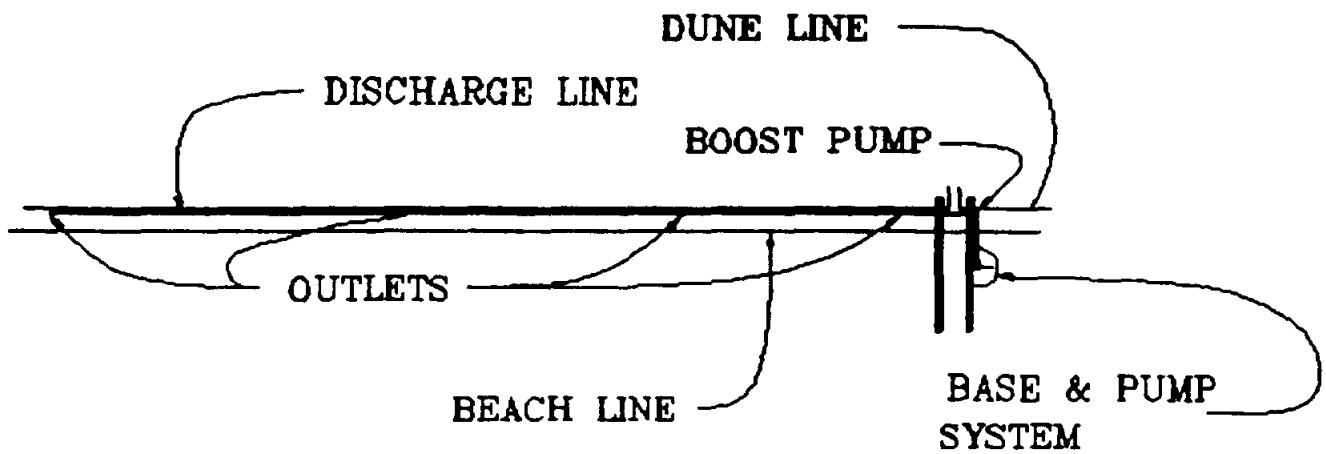

Figure 3.8: Pump Station Overall View

stability to the structure itself, as shown in figure 3.9. The structure is made of steel framing with heavy corrugated siding and roof. The crane assembly is a hydraulically operated boom crane with a boom length of 50 feet and turn radius of 360 degrees. All controls for movement and positioning are powered by hydraulics.

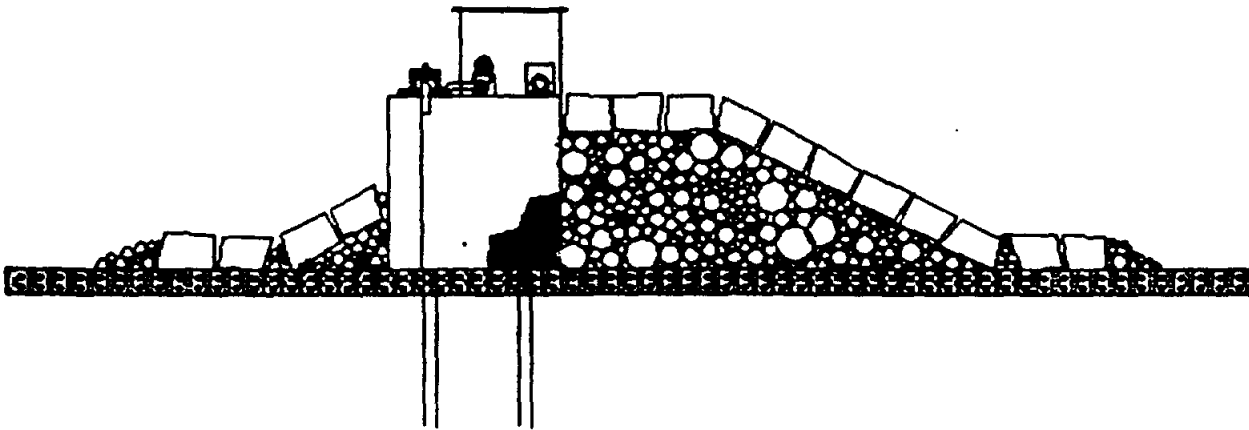

Figure 3.9: Pump Station Base/Jetty Integration

The intake (i.e. suction) system is based on the simplicity of a suction dredge. By this, a suction pump creates a force of great enough magnitude to pull the sediment from the sea floor along with water which acts as a suspending agent. This slurry solution can then be pumped to a point, via a piping network, where it can be discharged to areas of erosion. The intake nozzle is suspended from the boom by steel cables (see figure 3.10). This configuration allows flexibility in the positioning of the suction nozzle permitting up to 60 feet or greater reach for suction operations.

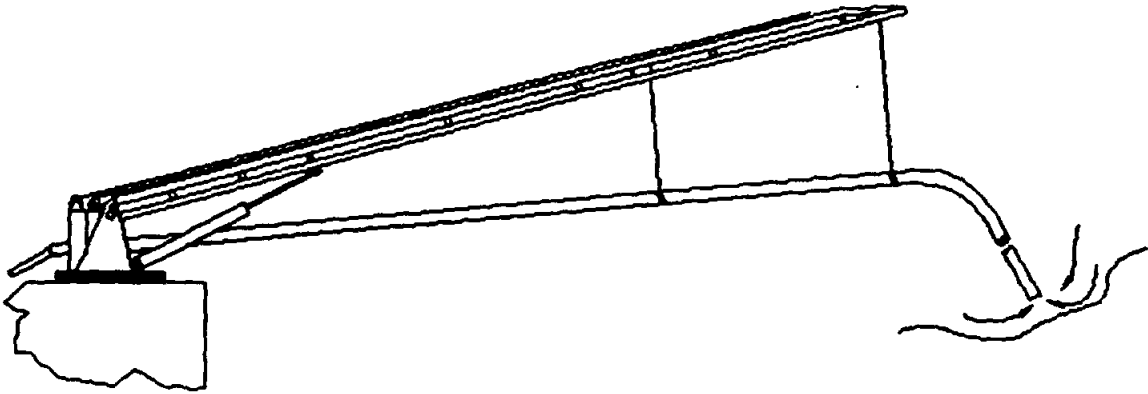

Figure 3.10: Crane and Intake Design

Discharge of the sediment is accomplished via a piping system which carries the sediment from the pump station to a shore based booster pump which continues pumping the sediment along the discharge system. From the booster pump, the discharge pipe is directed to a depth of 8 feet below the beach level where it proceeds under the jetty system. From there it rises to a depth of 4 feet where the first of four outlet valves is encountered 80 feet from the south jetty, see figure 3.8. The outlet valve, see figure 3.11, consists of an extension to the surface and a valve to open the pipeline for discharging onto the beach. A secondary pipe may be attached to the outlet valve if it is desired to



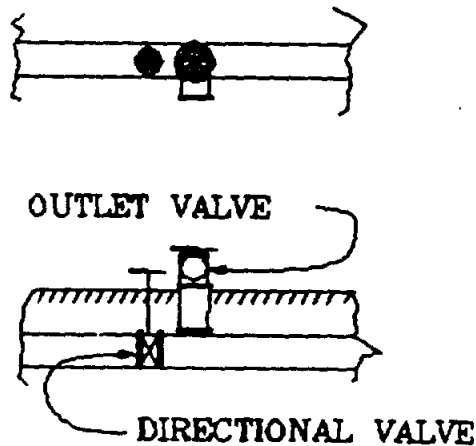

Figure 3.11: Outlet Valve Configuration

discharge the sediment further offshore. From this valve, the discharge pipe system proceeds to the rest of the outlet valves at 1760 foot intervals. This discharge system allows the discharge of the sediment for up to one mile south-west of the Rollover Pass jetties facilitating feeder beaches where they are needed. Figure 3.8 depicts the discharge line and the outlet points for reference to the beach.

The machinery necessary consists of a hydraulic unit with a 10 gallon minimum reserve capacity, a centrifuge type booster pump, and a Moyno 2J175G1 CSQ cavity pump, or similar centrifuge type pump, for the suction operations. The Moyno cavity pump is capable of pumping 800 GPM which in considering an approximate 15% [6] concentration of sediment

equates to about 87 cubic yards per hour of sediment transport. In considering the average eight hour work day, about 609 cubic yards of sediment can be transported per day. The layout of the hydraulic unit and the suction pump can be seen in figure 3.12 where the position of the booster pump can be seen in figure 3.8.

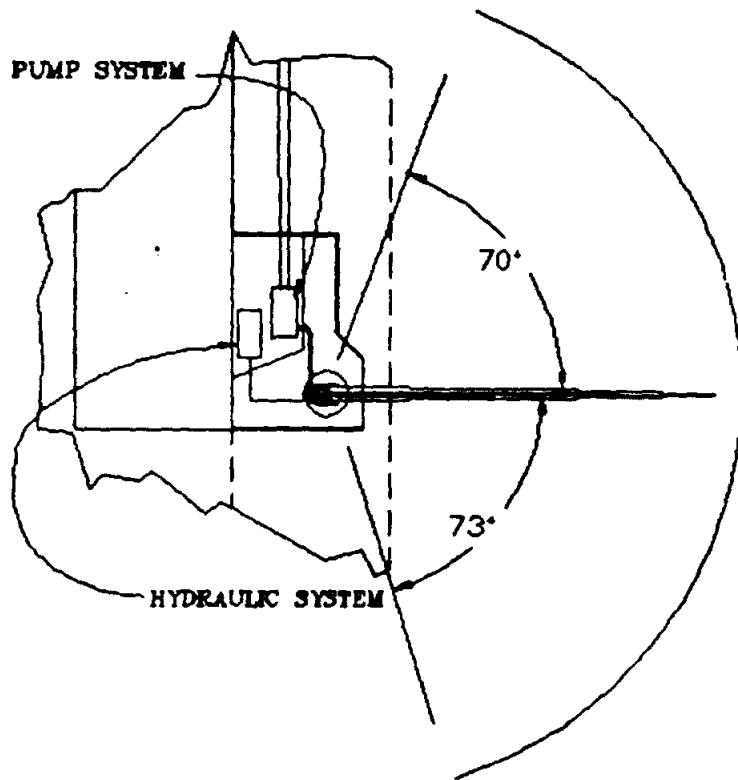

Figure 3.12: Equipment Layout

3.5.

3.4.3. COST-BENEFIT ANALYSIS OF DESIGNS A & B

In considering the cost analysis of the two different systems, two different concepts must be considered. First the dragline system is based on a yearly operation. Therefore table 3.4 describes the cost of a single by-passing operation contracted during the time period that this report was researched. For the fixed pump station design, the costs are based on a ten year life-span of the equipment, see table 3.5, even though most of the system will be of use for a considerably longer time.

RENTAL EQUIPMENT:

DRAGLINE	= \$2.25 CU.YD.	= 65,000 CU.YD.	= \$146,250
BULLDOZER	= \$5000 MONTH	= 1 MONTH	= \$5,000

SHIPPING:

DRAGLINE	= \$2000
BULLDOZER	= \$1000

---

TOTAL	= \$154,270
OVERHEAD	% 1.15

---

TOTAL	= \$177,410
-------	-------------

Table 3.4: Cost Analysis for Dragline

BASE STRUCTURE	= \$ 880,000
BUILDING STRUCTURE	= \$ 45,000
BOOM SYSTEM	= \$ 95,000
DISCHARGE SYSTEM:	
PIPE SYSTEM	= \$ 195,000
VALVES & MISC.	= \$ 95,000
MACHINERY	= \$ 120,000
VARIABLE COSTS:	
MANPOWER	= \$ 800,000
OPERATION & MAINTENANCE	= \$ 100,000
<hr/>	
TOTAL	= \$ 2,330,000

Table 3.5: Cost Analysis for Fixed Pump Station

3.6 3.4.4. SELECTION BETWEEN ALTERNATIVE DESIGNS

In taking into consideration all of the mentioned facts, the dragline system was chosen primarily because of the cost difference between the two systems. This is not to say that the fixed by-passing system should be ruled out. Both system are feasible and are due equal consideration.

### 3.4.5. BIBLIOGRAPHY

1. U.S. Army Corps of Engineers. Shore Protection Manual. Galveston, Texas: U.S. Army Corps of Engineers, 1984: Volume I & II, 5-39, 5-75, 6-57, 6-60.
2. Bruun, Per. Port Engineering. Houston, Texas. Gulf Publishing Co., 1976. pp 376.
3. U.S. Army Corps of Engineers. Galveston County Shore Erosion Study. Galveston, Texas: U.S. Army Corps of Engineers, 1985: Volume II, 24, 34.
4. Abbet, W. Robert. American Civil Engineers Practice. New York: John Wiley & Sons, Inc., 1956: 9-04.
5. Sefcik, Dan, Engineer, Hunter Construction Company. personal interview, 17 November 1989.
6. Robbins & Myers, Moyno 2000 Pump Manufacturer; Springfield, Ohio

### 3.4.6. Works Consulted

Brunn, Per. Design and Construction of Mounds for Break Waters and Coastal Protection. New York, New York. Elsevier Science Publishing Co., Inc., 1985, pp 839.

Bruun, Per. "Coastal Engineering Santa Barbara." Conference on Coastal Engineering 1957. Ed. 1957, pp 579-610

Bruun, Per. "Stability of Tidal Inlets Use Hydraulic Pressure for Channel and Bypassing Stability." Beach Preservation Technology 1988. Florida, 1988, pp 325-334

Galvin, C. "Shoaling with Bypassing for Channels at Tidal Inlet." Coastal Engineering 1982 Proceedings. Ed. Billy L. Edge. Cape Town, Republic of South Africa, 1982. vol.II, pp 1496-1513

Johnson, C. N. and Hlipakka L. W. "Sand-Bypass and Shore Erosion, Bredgeman, Michigan." Coastal Engineering 1976 Proceedings. Honolulu, Hawaii, 1976, vol.II, pp 1361-1376

McNair, E. C. "Sand Bypassing System Using a Jet Pump." Coastal Engineering 1976 Proceedings. Honolulu, Hawaii, 1976, vol.II, pp 1342-1360

Muir Wood, A. M. and Flemming, C. A. Coastal Hydraulics. New York, New York. Pub. John Wiley & Sons, 1981, pp 144, 188

Prather, S. H. and Sorensen, R. M. A Field Investigation of Rollover Fish Pass, Bolivar Peninsula, Texas. Texas A&M University, Texas. Texas A&M University, 1972

Yauima, M., Vezuro, A. and Yauchi, T. "Application of Sand Bypassing to Amanohashidate Beach." Coastal Engineering in Japan. Tokyo, Japan, 1983, vol. 26, pp 151-162

Zurmchlen, F. H. "The Transfer Plant at Lake Worth Inlet." Conference on Coastal Engineering 1957. Ed. 1957, pp 459-462

CHAPTER 4 ENVIRONMENTAL IMPACT STATEMENT  
Designers: Michael E. Duncan, Darrel K. Pelley & Jung E. Yoon

TABLE OF CONTENTS

ABSTRACT

4.1. INTRODUCTION

4.1.1	Brief Problem Description .....	1
4.1.2.	Regional climatology .....	3
4.1.2.1	Annual Rainfall	
4.1.2.2	Wind Climatology	
4.1.2.3	Wave Climatology	
4.1.2.4	Storm Activity	

4.1.3.	Physical Characteristics .....	5
4.1.3.1	Sediment Characteristics of Rollover Bay	

4.2. EFFECTS ON WATER HYDROLOGY .....

4.2.1.	Volume Change To Rollover Bay Due to Dredging ....	7
4.2.2.	Salinity Effects .....	8
4.2.3.	Effects On Bay Flushing .....	12
4.2.4.	Water Quality Effects .....	13

4.3. Effects On Ecological & Biological Systems

4.3.1.	Effects On Benthic Organisms .....	16
4.3.2.	Effect on Shore Birds .....	17
4.3.3.	Effects of Marshland Creation .....	17

4.4. Legal Considerations .....

APPENDIX: Letter of Transmittal

#### ABSTRACT

The Rollover fish pass is a man-made artificially stabilized tidal inlet opened in 1954-1955 on the upper Texas coast approximately 19 miles east of the Galveston entrance on Bolivar peninsula [4:427]. Problems with scouring in the pass caused a closing for the installation of steel sheet piles along the sides of the pass. Since the re-opening in 1959, beach loss in the area around the pass has averaged 14 to 16 feet per year according to the U.S. Army Corps of Engineers (USACOE) [4:434]. Erosion rates for the two sides of the pass have differed since the opening in 1959-1960, with the rate of shoreline loss on the southwest side of the pass exceeding that of the Northwest. The implementation of an erosion control system at Rollover fish pass along the upper Texas coast will cause changes to occur within the existing environment. This statement is an analysis of these steps and will serve as guidelines for the construction and implementation of the system with a minimum of negative environmental effects. The scope of the report will include effects on the water hydrology of the Rollover and East bay systems, Changes in bay flushing and circulation, and effects on the surrounding areas including marsh lands and bay bottom. Bio-ecological effects will also be addressed. The environmental effects will be addressed to the memorandum dated 9 October 1989 to Dr. Y.H. Wang of Texas A&M University at Galveston concerning the characteristics of the project.



## I. Introduction.

### 1.1 Brief Problem Description.

The Rollover fish pass was initially opened in 1954-1955 by dredging a channel 80 feet by 8 feet across an area of the Bolivar peninsula where the maximum land elevation did not exceed 5 feet [4:429]. Stability problems with the pass caused the channel to scour to 500 feet wide at the seaward mouth and 30 feet deep in some locations [4:429]. In order to protect the structural integrity of the bridge crossing the pass, (highway 87), the inlet was closed in 1955 by driving sheet piles across the inlet on the seaward side of the pass. With the installation of steel sheet piles along the sides of the pass, the inlet was opened again in 1959 by driving the sheet piles down to a depth of 5 feet below mean sea level (MSL) [4:429]. Average depths for the pass as of April 1989 show an average depth of 3 to 4 feet [USDOC. Chart 11331-SC].

Estimates of Erosion rates along the Gulf shore at the pass vary. These variations are shown in table I [4:434].

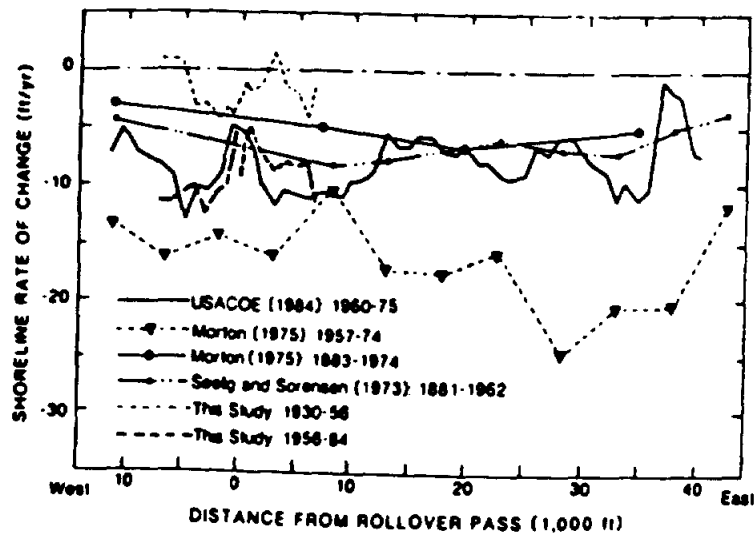

From the data in the table, we can see that the rate of shoreline change on the southwest side of the pass exceeded by 2.1 feet per year.

The change on the north east side for the period 1956 to 1984. These figures are taken for a linear distance of 6900 feet to either side of the inlet. The USACOE 1984 Study concluded that approximately 9000 cu. yards of sand per year are lost on the down-drift side of the pass (6900 ft.) due to excess beach erosion [4:434]. It has also been shown that the erosion rates for the ROP area have exceeded the pre-pass erosion rates by between 3 and 12 feet per year [4:435].

Based on a hypothesis that net tidal-inlet sand transport is approximately equal to the excess beach erosion downdrift of the pass, it can be deduced that the net transport of sand through the Rollover fish pass is from 9000 to 26000 cu.yds per year. Note that these figures are not consistent with the rates calculated from excess dredging in the Gulf Intracoastal Waterway (GIWW) [4:435]. Increased maintenance dredging of the GIWW since the opening of the ROP would indicate that a percentage of the material filling the GIWW is littoral material from the gulf funneled through the bay in constricted channels at velocities of up to 6 ft/sec. during the first portion of the flood tide [4:435].

In Rollover bay, severe sedimentation has occurred over the past thirty years due to the flood-dominant characteristics of the inlet. Indeed, visual inspection and photographs aken on Friday October 20, during the ebb tide show most of the bay

bottom exposed. Tidal data for the day supplied by the National Ocean Survey, U.S. Department of Commerce shows a low tide of 0.0 ft above MLLW at 1439 hrs [USDOC 11331-SC]. The flood-domination of the inlet is causing littoral material to be drawn into the bay and deposited on the bay bottom. Soil samples taken in October 1989 at several locations in the bay have shown a strong similarity to materials on the gulf side beaches in the area of the pass. These results will be presented in a later section of this report.

## 1.2 Climate Characteristics, Galveston Bay System.

### 1.2.1 Annual Rainfall.

The climate of the Texas Gulf coast is generally characterized by short mild winters and long hot summers. The annual rainfall for the region averages about 45 inches. The amount of rainfall received on an annual basis has a direct effect on the salinity regimes in the East bay system. The east and Rollover bay systems are fed by a number of tributaries, including the Trinity river and the East bay bayou on the east side of the ROP. During dry spells, the amount of evaporated water from the bay tends to cause a small corresponding rise in salinity since salt crystals cannot be evaporated.

### 1.2.2 Wind Climatology

Wind conditions in the gulf show predominant wind velocities

of 8 to 15 miles per hour from the south-southeast for more than 60 percent of the year. As a result of the predominant wind conditions, longshore littoral transport is generally from east to west. On an annual basis, 15 to 20 fast moving polar fronts pass through the area bringing offshore or northerly winds of up to 50 mph [4:428]. These fronts are most common during the winter months; December, January and February. Preceding the passage of a front, a period of strong onshore winds (southerly) generate stronger than usual wave activity.

#### 1.2.3 Wave Climatology.

The wave climate of the area can be described as fairly calm, with waves of height exceeding 4.5 feet occur only 1 to 3 percent of the time. Wave heights are less than 2 feet 25 to 50 percent of the time [USACOE 1984].

#### 1.2.4 Storm Activity.

From 1900 to 1984, twelve hurricanes made landfall less than 40 miles from the Rollover pass. The greatest surge height was recorded in 1961 during Hurricane Carla, which came ashore 150 miles southwest of the Rollover pass [USACOE 1984]. On average, surges greater than 5 feet have occurred at ROP every 2 to 3 years [Morton 1975]. A discussion of the beach profile changes due to storm activity will be included in a later section.

The following compilation presents a short summary of the general climatology for the ROP area.

TABLE II: Local Climatology.

---

Predominant winds from the South-Southeast at 8 to 15 mph, with a number of strong polar fronts moving through the area during the winter months.

Short Winter seasons with mild temperatures, and the occurrence of polar fronts most common during the deep winter months (December, January, and February).

Long, hot Summer seasons with high humidities and an average annual rainfall of 45 inches.

The coastal area is subject to tropical storms of hurricane force at irregular intervals. This storm activity can result in rapid significant changes in beach profiles.

NOTE: The winter beach profile is characterized by a steeper nearshore slope and large offshore bars.

### 1.3 Physical Characteristics of the Rollover Bay Area

#### 1.3.1. Regional Sediment Characteristics

The Geomorphology of the Texas Gulf Coast is that of a typical Depositional Barrier Island shoreline. Barrier island beaches are well sorted, coarse grained sedimentary deposits which serve to protect inland areas from storm activity and limit flow from estuarine bays and lagoons. Sediment is supplied to these beaches by material run-off from upland river systems and is carried down

the shoreline by longshore currents. The materials which comprise the barrier island beach are clastic sedimentary deposits which range in texture from clay to sand. Figure 1 illustrates a typical sediment distribution in the coastal zone.

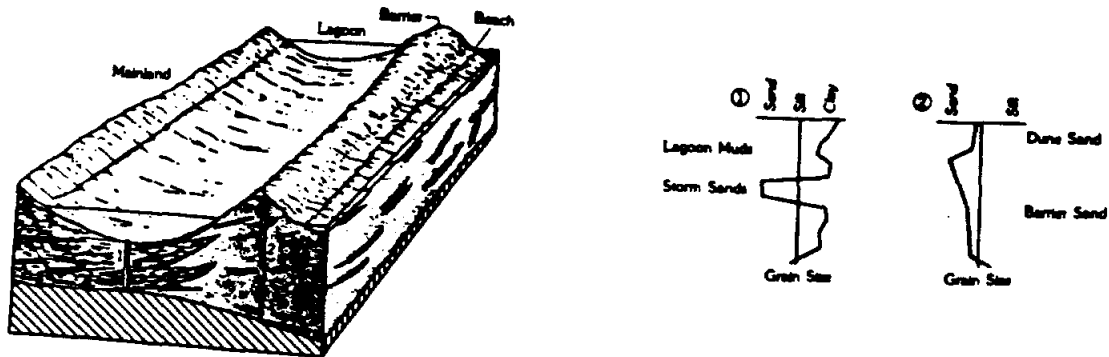

Fig. 1 from (9) p.61  
Environments of clastic deposition  
in the coastal zone.

Shoreline configuration along a depositional coast is highly dependant on wave activity and sediment supply. Barrier islands will adjust their configuration to adapt to a changing wave climate or a fluctuation in sediment supply. Rollover Fish Pass (ROP) and Rollover Bay (ROB) are examples of this dynamic interaction between land and sea.

ROB is, for the most part, a normal shallow water bay environment. Finer grained materials are concentrated in the low energy areas behind the dune line, while coarser grained sand is accumulated along the shoreline. The only peculiarity to be found in ROB is the presence of two bars which run on either side of ROP

back to the GIWW. These bars are approximately 100-150yds. wide, and were the subject of the sampling expedition to ROB.

Three samples were taken from the bars along with one from the nearby gulf coastline. Sieve analysis performed on the samples has shown that the grain size of the bar material is larger than the size of material found in the rest of ROB. It has also been noted that a coarser grain size is prevalent along the neighboring shoreline. Material from the bars was typically from .106 - .150mm in diameter, whereas material from the beach ranged from .150 - .180mm. It is believed that the bar material is sediment which has been removed from the shoreline by severe erosion on the gulf side of ROP. It is also believed that this erosion/deposition process is resulting in the "suffocation" of ROB. As the hydraulic equilibrium of Galveston Bay seeks to re-stabilize, the shoreline near ROP is migrating inland and re-forming in ROB, thus reducing circulation in ROB. Based on the results of the sieve analysis and the local geomorphology of the ROB area it has also been determined that the ROB bars are a suitable borrow site for a minor beach nourishment project.

## 2.0 Effects on Water Hydrology.

### 2.1 Volume Change at Rollover Bay.

The initial phase of the plan requires the removal of material deposited into RO bay from the gulf. A dredging operation in the bay will undoubtedly change the water volume of the bay. As we know, the average high tide depth in the bay is

between 0.5 and 1 foot. The dredging operation is predicted to increase this average depth to 3 feet. The result is tripling the current fluid volume in the bay. This extra water has to come from somewhere, and the inflow will be the combination of water from the east bay and the Gulf of Mexico.

## 2.2 Salinity:

The salinity regime in the Galveston Bay system is the result of tidal fluctuations and freshwater inflow to the bay system. The area in question, ie. the Roll-Over bay, has a significantly lower average salinity on a year round basis than the western portions of the bay, depending on the ratio of fresh to salt water inflow to the region from the East bay system over the Texas Intracoastal waterway. A computer program has been developed to demonstrate that a salinity rise in the bay would occur as a result of a dredging operation. The development of such a program cannot be taken as the definitive answer to the salinity change dilemma, however; by showing that the conditions present in the bay favor a positive increase in salinity, it can be shown that the salinity of the ROB is a matter of concern. Parameters for the program have been taken from U.S. Department of Commerce Nautical chart No. 11331-SC, and from the 1987 final report of the Galveston bay Navigation Study plan H50G for the widening and deepening of the Houston Ship Channel.



Parameters are as follows:

1. Maximum tidal flow over a 25 hour period between .7 and 4.2 ft/s [Prather and Sorensen, 1972]. Flood and Ebb tidal values were not distinguished, but the report stated that R-O pass is a flood-dominant tidal inlet.
2. Average baseline salinity in the East bay-ROP areas between 16.9 and 17.2 ppt. with fluctuations of less than 1 ppt.(+/-) over the next fifty years to 2045.
3. Average baseline salinity in the Gulf of Mexico of 28-29 ppt. depending on the average annual rainfall in the coastal region.
4. Final dredge depth of 3 ft. in the RO bay dependant on the results of preliminary soil analysis completed at Texas A&M University in late 1989.
5. Maximum tidal velocity of 6 ft./s through ROP during the flood tidal movement.
6. A fixed control volume for analysis.

The program uses a relation between the cross-sectional area of inlets from the bay and gulf systems including the TICW contribution. By modelling the RO bay with a simple program, we can show that a resultant rise of salinity due to dredging would occur.

The ROP has been described as a flood-dominated tidal inlet, with evidence for and against this ascertainment. Circumstantial evidence exists to show that ROP is in fact flood dominant. Observations have shown that the scour hole on the bay side of the weir tend to be deeper than the scour hole on the seaward side. The difference in depth indicates:

- (1) Flood flow velocities typically exceed ebb flow velocities.
- (2) Bedload transport to the weir is greater during the flood flow period.

In addition, Prather and Sorensen (1972) made velocity measurements in the ROP, primarily over a single 25 hour period. The velocity difference between the flood and ebb tidal flows respectively was 4.2 to 0.7 ft/sec. In 1981, C. Mason, in his "Hydraulics and stability of five Texas inlets" showed 6 and 2 ft./sec over a 31 hour period for the flood and ebb flows. Bales and Holley also measured velocity in 1985 and found that the velocities on the flood and ebb tides were in fact very close i.e. 4.0 and 3.0 ft/sec.. The program uses a finite volume and simulates the flow of varied-salinity water into the volume as a percentage of the total finite volume.

Using the velocity information above, and the assumption that the ROP is in fact flood dominant, The computer program was run to determine the change in salinity with respect to the increased volume of a dredged bay. The results are shown in APPENDIX I, and demonstrate that a positive increase, although minute would occur.

From the results of the program rises the question of the effect of increased salinity on the bay. Trends for the year 1989 have shown a significant reduction in the oyster population due to low salinity in the bay system. If the trend toward high freshwater inflow continues into the future, then the salinity rise would have no significant detrimental effect on the bay system.

The Houston Ship Channel to the west provides a "salinity barrier" separating the east and west bay areas. As a result of

this separation, the bay salinity regimes are split at the Houston ship channel. An initial dredging of the pass and bay areas could potentially create a sub-surface channel allowing high-salinity water to penetrate into the bay. The resultant increase in average salinity could have an adverse effect on the organisms in the area, if the change in salinity is too great. The change predicted from the program; however, does not show a significant rise in salinity after implementation of the project. It is expected that the Trinity bay area would experience a rise in salinity of 1.10 ppt under plan R50 of the Galveston bay Navigation Study, 1986 involving the widening of the Houston Ship Channel. A similar rise, although smaller in magnitude, due to the dredging of Roll-Over bay could result due to the closer locality of the salt penetration. Roll-Over bay presently shows a baseline salinity of 16 ppt.; however a regime as high as 17 ppt. could become the norm following a large-volume dredging project. The following data shows the present baseline salinity regimes in the east bay system according to the U.S. Army Corps of Engineers Galveston Bay Navigation Study of 1986:

TABLE 1: Baseline Salinity in the East Bay System

---

North Trinity bay, and deltaic marsh:	9-11 ppt.
Roll-Over Bay, Texas h.87 to TIWW:	14-16 ppt.
Gulf of Mexico, Bolivar Peninsula:	28-32 ppt.^D
Predicted Salinity, RO bay after dredging to an average depth of 3 feet:	16.5-17 ppt.

\* Data taken from Galveston Bay Navigation Study, 1986 concerning plan H50 for the widening and deepening of the Houston Ship Channel from the Bolivar Roads entrance to the Houston turning basin.

B. Bay Area Flushing:

Definition of Flushing Rate:

1. Freshwater Flow Definition. The time required for the bay volume to be replaced by freshwater inflow.
2. Tidal Flow Definition. The time required to replace the bay volume through successive tidal exchanges. It should be noted that a typical tidal excursion in Galveston bay is between 4 and 6 miles. As a result, on the ebb tide, much of the water does not leave the bay, but merely moves up and down the bay. This does not strictly apply in the R-O bay area due to the shape of the R-O bay.

[USACOE, 1986]

The first factor to consider is the tidal differential for the ROP area. For the Entire Galveston Bay system, a 1 foot average diurnal tide can be assumed, but the actual differentials in the different parts of the bay vary. There is approximately a four hour lag between the occurrence of high tide on the gulf side of ROP and the high tide on the north side in the East bay. This phase difference is evidence that the water levels in the bay are more influenced by flow through the Galveston entrance than through the ROP [Bales and Holley, 1986; Mason, 1981]. The observed tidal median in the area is 0.55 feet [Prather and

Sorensen, 1986; USACOE, 1959]. The velocity measurements made by Bales and Holley in 1985 were taken at tidal differentials of 0.6, 0.9, and 1.0 feet (above MLLW). Roll-Over pass obviously allows for increased circulation in comparison with the Northern sections of the bay and the Ship Channel. Because of the physical shape of the R-O bay, it is assumed that the water is exchanged on a regular basis due to the pass directly connecting it with the Gulf. At the present time, the average depth in R-O bay is approximately 0.5 to 1 foot (at high tide). During the ebb tide, much of the bay bottom is exposed as observed by team members on 20 October 1989. Depending on the volume of sediment to be removed from the system, the flushing time for the R-O bay area could be reduced by up to 10 percent. There are several factors to be considered in this case:

1. The salinity difference due to the increased inflow of gulf water into the bay.
2. Depending on the calculation method, the flush rate reduction could be less than expected initially.
3. According to the Galveston Bay Navigation Study, 1986, the flushing rate has no apparent relation to higher fishery yields, even though analyses have been conducted by the Texas dept. of Water Resources.

#### Turbidity and Water Quality:

The water quality in the Galveston bay system is generally classified as good along the southern portions of the bay due to the close proximity of the Gulf of Mexico and frequent flushing

of the area for the same reason. Although the water quality in the Trinity bay is also good, the salinity is much lower due to the outlet from the main channel of the Trinity river. The deepening of the R-O bay area is not expected to reduce the water quality in the bay because of the reduction of flushing time due to dredging.

The amount of dissolved solids in the water column would be affected depending on the placement of a groin system around the pass. Currently, the plan is calling for the construction of parallel jetties on the gulf side of ROP to interrupt the littoral flow drawn into the pass by the suction formed in the bay by the tidal time lag. If the littoral flow is reduced, and the amount of suspended littoral material decreased accordingly, then it can be deduced that decreased sediment transport into the bay would accordingly decrease the suspended sediment percentage in the water column. It can be assumed that there will be a higher amount of suspended solids in the bay during the construction phase, specifically during the dredge-portion of the operation. The dredging will stir up a considerable amount of the small sediment particles during material removal. The influence of the Galveston entrance on the tidal flow of the ROP area would therefore draw this mass of water further into the bay during correct tidal conditions. As a result, during the construction phase of the project, it is expected that the percentage of suspended solids in the water column of the east bay would increase. After the construction is complete, it is also expected that the suspended

solid percentage would decrease to normal or below-normal levels. Note that this is a construction and not a maintenance operation, involving the removal of "virgin" material from a source and re-deposition at another location. A maintenance dredging operation involves the removal of relatively more contaminated material for redeposition, and as such, it has been decided that material in close proximity to the TIWW not be considered in the calculation of available sediment resources in the Rollover bay. In short, a long-term decline in water quality is not expected.

### 3.0 Effects on ecological and biological systems

#### 3.1 Effects on benthic organisms

The proposed design plan will have a physical effects on benthos, or the bottom dwelling organisms including polychaetes, small crustaceans, and mollusks, which are very important in the esturine food chain and contribute significantly to the productivity of the surrounding area. A temporary loss of benthic population would occur as a result of the proposed plan (12).

This would occur during the dredging operation. When the sediment is transported from the bay and piled up for the drying process, probably all of the organisms would suffocate. In the construction of the jetties, similar effects would occur by moving equipment and the jetty material. During the sand by-passing process, the benthic organisms would suffocate while the sediments are being transported to the desired location (6:Vol. I:EIS 3-6).

However, the benthic organisms have a very dynamic reproductive rate and they are expected to reestablish their presence in these regions or the adjacent regions (in the case of the jetties), either during or after the completion of the proposed plan (12 and 6:Vol.I:EIS 4-2).

Also, due to the relatively coarse characteristics of the local sediment, the gulfside environment is not very conducive to polychaete worm habitation but under our proposed plan, the beach



fill material will be finer than the existing sediment, and will provide a better habitat for polychaetes. This, in turn, will provide more food sources for fish and shorebirds (12).

Since the effect on the benthos will be a temporary loss of food source for fish and shorebirds, the plan may cause the affected species to feed in the surround or adjacent area temporarily until the benthic community reestablishes at the beach site and in the bay. We feel, therefore, that the long-term effects on the benthos will be minimal or nearly null (12).

### 3.2 Effects on shorebirds

The sand pit area inside the bay, which is one of the proposed sediment sources for the beach nourishment, is currently used as a bird loafing and feeding area. These birds include white pelicans, laughing gulls, ring-billed gulls, Caspian terns, Foster's tern, black skimmers and several other birds. As I mentioned earlier, reduction in benthic population would cause the birds to feed in the neighboring area temporarily (11 and 6:Vol. III:4).

### 3.3 Effects of creation of marshland

With our proposed plan, after the dredging, the bay bottom will be contoured to form small channels, thus allowing for salt water inundation. Also, the eastern section of the bay sand pit area will be dredged deeper than other area to allow small

organisms to travel and to create better water circulation within any newly created wetlands (11).

The creation of a wetland, very briefly described, would entail the planting of vegetation (cordgrass) in the bay. The creation of a wetland would also make the area more biologically productive, and more species of biota would be able to utilize the area (11).

The benefit from creating this wetland cannot be measured with a dollar figure, but I would like to compare our proposed plan with a plan of an engineering firm in California, near L. A.

Maguire and Thomas Partners, a development firm owns 957 acres of wetland approximately an hour outside L. A. This wetland, due to the construction of the flood control levee, receives poor quality of water that drains from the vicinity. In order for this firm to develop their land they donated 216 acres of this wetland and \$10 million to the National Audubon Society to restore the normal tidal cycle through the usage of computer operated flow system (13:45-6).

The creation of wetland, in the proposed project, does not require the large sum of money as in the case of the wetland in California and bring as much benefit to the region. In other words, the cost of creating a wetland in itself is high but in the proposed plan, two benefits from one plan is gained by improving shoreline conditions of the Rollover Pass area and turning the bay into a more productive wetland.

#### 4.0 Legal considerations

The aim of this sections of the paper was to bring out some aspects of the environmental concerns that may arise from our proposed plan and to inform the community that if this plan is chosen, a much more in-depth study for the total feasibility, in every aspect, must be made before the plan is submitted for approval. In order for this proposed project to get off the ground, and be submitted to the state for the allocation of funds, there is a list of environmental requirements that must be met. This meaning that this plan must comply with various acts and laws. This is the list of various environmental requirements that I thought may apply to this project. There may also be other regulations that may be fulfilled.

---

#### CURRENT LEGISLATION

---

CLEAN WATER ACT

CLEAN AIR ACT

COASTAL ZONE MANAGEMENT ACT

ENDANGERED SPECIES ACT

FISH AND WILDLIFE COORDINATION ACT

MARINE PROTECTION, RESEARCH AND SANCTUARIES

NATIONAL ENVIRONMENTAL POLICY ACT

FLOODPLAIN MANAGEMENT (EXECUTIVE ORDER 11088)

PROTECTION OF WETLAND (EXECUTIVE ORDER 11990)

TEXAS COASTAL ZONE MANAGEMENT ACT

TEXAS WATER QUALITY CERTIFICATE

APPENDIX  
M E M O R A N D U M

To: Dr. Y.H. Wang, PhD.  
From: Mike Duncan  
Darrel Pelley  
Jung Ho Yoon  
Date: 09 October 1989  
Subject: Determination of Analysis areas for Environmental  
Impact Statement.

Re: MASE 407-401 Design of a Erosion Control System for  
The Roll-Over Bay and Fish Pass.

Environmental Impact and Feasibility Analysis Team  
Basic Project Characteristics for the Control of  
Erosion at Rollover Bay, Texas.

Assumed Project for Reference:

- I. Initial dredging of the Roll-Over bay to a certain depth, creating a source of sediment for an initial local beach profile nourishment in the Fish Pass area.
- II. Design and construction of a sand by-pass system to continually nourish the beach profile.
  - a. Construction of parallel rubble-mound jetties on the east and west sides of the R.O.P to maintain a steady beach profile through controlled interruption of the littoral transport into R-O bay.
  - b. Design and construction of a pumping station to transport sediment to the beach along the west side of the pass from the collection area on the east side.
- III. Use of the pumping station to pump recovered sediment to the beach profile from the sediment collection area along the east side of the gulf coast at the fish pass.

\* Data partially supplied by Miles Gathright of the design team of MASE 407-401

# ROLLOVER PASS MASE 407 Project

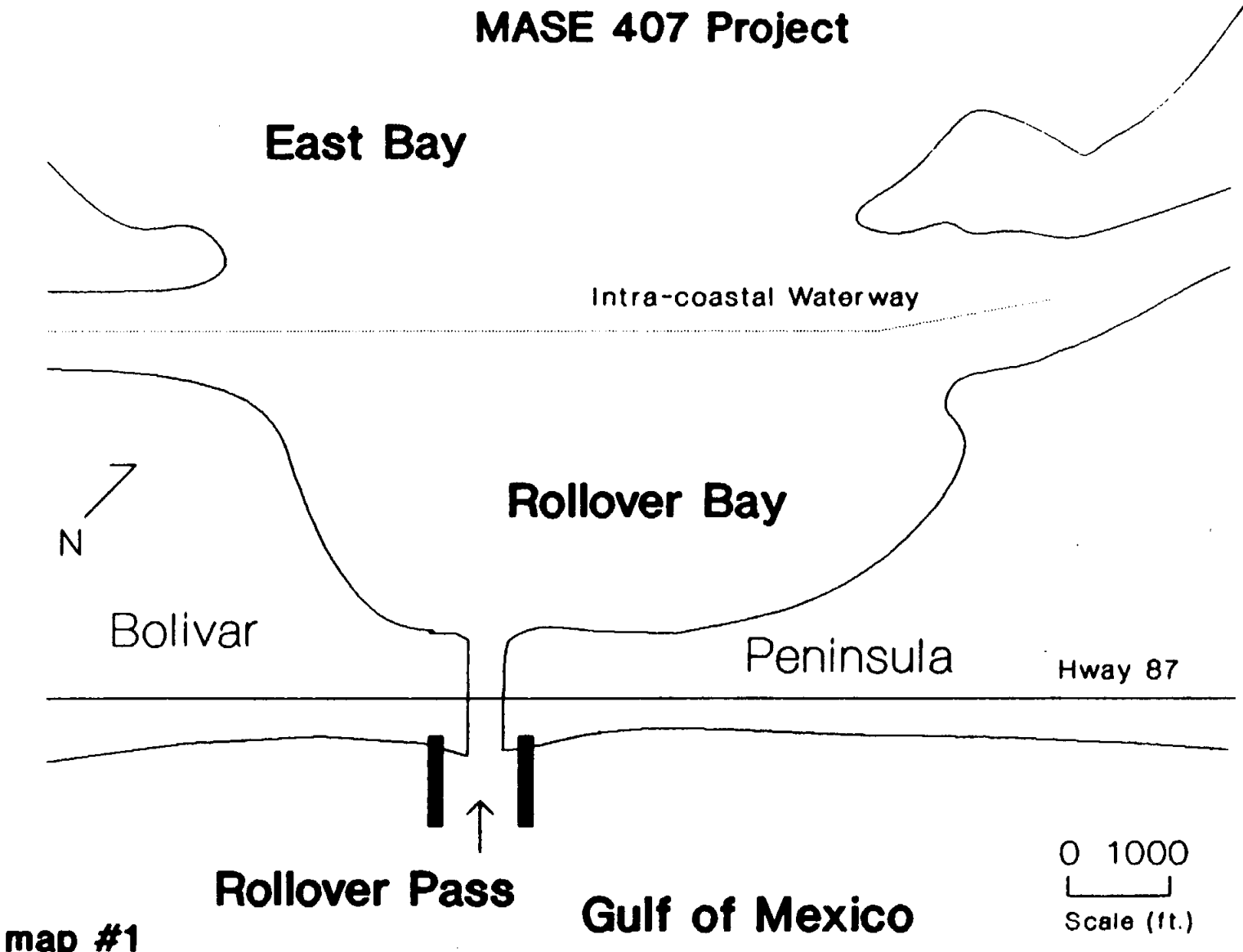

map #1

0 1000  
Scale (ft.)

APPENDIX G

SHORELINE EROSION SEMINAR  
QUANTITATIVE ANALYSIS AND DESIGN ASPECTS  
of  
SHORELINE PROTECTION IN GALVESTON COUNTY, TEXAS

This is a supplement of the final technical report on Shoreline Protection and Implementation Options for Galveston County, Texas, submitted to Dannenbaum Engineering Corporation, prepared by Dr. Y.H. Wang, College of Geosciences and Maritime Studies, Texas A&M University, Galveston, Texas 77553-1675.

TWDB contract no. 90-483-771  
DEC subcontract no RF-90-1142-6737

# SHORELINE EROSION SEMINAR

Galveston County, Texas

Quantitative Analysis and Design Aspects

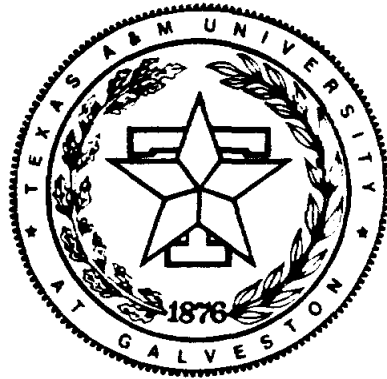

**DEC**

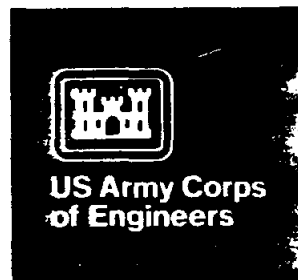

December 14, 1991

Texas A&M University at Galveston  
Auditorium, Building 3007, Pelican Island  
200 Seawolf Park Blvd.  
Galveston, Texas 77553

# **SHORELINE EROSION SEMINAR**

## **Galveston County, Texas**

### **Quantitative Analysis and Design Aspects**

**December 14, 1991**

**Texas A&M University at Galveston  
Auditorium, Building 3007, Pelican Island  
200 Seawolf Park Blvd.  
Galveston, Texas 77553**

#### **SPONSORED JOINTLY BY**

**Texas A&M University at Galveston  
Dannenbaum Engineering Corporation, Houston, Tx.  
U.S.Army Corps of Engineers, Galveston District  
Galveston County Shore and Beach Preservation Association  
Galveston County Beach Park Board of Trustees**

#### **SEMINAR CHAIRMEN**

**Y.H. Wang, Co-Chair  
Texas A&M University at Galveston  
P.O.Box 1675  
Galveston, Texas 77553**

**A.F. Frankovich, Co-Chair  
Dannenbaum Engineering Corporation  
3100 West Alabama  
Houston, Texas 77098**



## FOREWORD

The SHORELINE EROSION SEMINAR, GALVESTON COUNTY, TEXAS was organized as a technical conference concerning the quantitative analysis and design aspects of combating beach erosion along the Galveston shoreline. There have been ample discussions and numerous debates on shoreline problems, solutions and management policies in the past. Sometimes these issues generated enormous emotional public outcry. However, feelings without agenda cause stagnation and confusion. This conference is designed to move the process forward by providing an agenda for implementation.

The SHORELINE EROSION SEMINAR started with the employment of conventional means for beach erosion control and followed with some new and emerging technology applications. The purpose of this program structure was to promote a broad exchange of information between regulators and practitioner, scientist and engineer, and environmentalist and developer.

The editor acknowledges generous contributions of the speakers. Some of them traveled long distances from out of state in order to present their ideas. Many papers in the proceedings are derived from the project supported by Galveston County and the Texas Water Commission through Dannenbaum Engineering Corporation. Without their financial support this conference would not have been possible. The approval and encouragement of the sponsors is gratefully acknowledged. Special thanks are due to Mr. Pat Hallisey of the Galveston County Beach Park Board of Trustees for his support and encouragement.

The logistical supports were provided by Mr. Ronnie Barcak who typed and formatted the proceedings, Mr. Paul Wilson, Ms. Rosann Heflin, Ms. Theo Byrne, Ms. Joyce Dryman, and Mr. Charles Lee all contributed to the smooth operation of the conference.

It is hoped the energy exhibited during this initial undertaking will help form a basis for clearer understanding of the technology available to solve Galveston County's problems.

Editor  
Y.H. Wang

## CONTENTS

<b>Overview of Galveston County Shoreline Problems</b> Y.H. Wang.....	1
--	---

### CONVENTION TECHNOLOGY

<b>Proposal For Improvements To Rollover Pass, Bolivar Peninsula, TX</b> Darrel K. Pelley.....	22
<b>Detached Offshore Breakwater Design for Galveston County</b> Alan D. Black and Mike Strech.....	34
<b>Design of Beach Norishment for Galveston Island</b> Frank Frankovich.....	47a
<b>Alternative Sand Sources for Beach Nourishment</b> Mark E. Leadon and Y.H. Wang.....	48
<b>Erosion Control for Ferry Landing Road</b> E.M. Taylor, K.L. Heydinger and B. Aley.....	*
<b>A Solution for Flank Erosion at the West End of Galveston Seawall</b> A.A. Barrera and J.J. Kahl.....	*

### NEW AND EMERGING TECHNOLOGY

<b>Space Shuttle Observations of Suspended Sediment, Galveston Island</b> Mike Duncan.....	58
<b>Nearshore Berm for Galveston Island, Texas</b> T. Neil McLellan.....	59
<b>The Modification and Layout of the Galveston Island Groin Field</b> Y.H. Wang and R.G. Barcak.....	69
<b>Dune Restoration at Galveston West Beach</b> Y.H. Wang.....	79
<b>The Use of Viscous Drag Mats to Prevent Shoreline Erosion</b> Peter Alsop.....	86
<b>Energy Absorbing Revetment for Bay Shore Erosion Control</b> D.R. McCreary.....	101
<b>Jet Pump Application for Beach Replenishment at Big Reef, Galveston</b> D.M. McMahon and B.G. Gates.....	116
<b>Horizontal Dewatering System for Shoreline Stabilization</b> Donald R. Justice.....	120

\* Manuscript not available at the time of printing

# OVERVIEW OF GALVESTON COUNTY SHORELINE PROBLEMS

Y.H. Wang\*

**ABSTRACT:** This report identifies the problem areas on the shoreline of Galveston County, establishes objectives for treatment, and suggests options for remedial measures. This is presented in the light of understanding the physical environment and littoral transport processes of a much larger geographical frame.

## INTRODUCTION

The Galveston region has several coastal problem areas that need shoreline protection implementation. There are two functional entities that are common to all the project sites; the forcing function such as natural forces in the coastal zone and the response function such as location parameters. Understanding these two functions and their interactions at different project sites will provide valuable information for better project decisions and/or implementation.

When physical environment is mentioned in the coastal region thoughts on natural processes comes to mind.

Location parameters such as the orientation of shoreline, sheltered or exposed, open to long or short fetch, bottom topography, and sediment materials, etc. Natural forces, such as waves, tides, winds, and currents, etc. that shape up the bottom configuration of the coast zone. The interaction of these two, or the natural processes, determine the shoreline change in that region. Shoreline changes are also possible through man's interference of the natural

---

\* Professor and Professional Engineer, Texas A&M University at Galveston, P.O.Box 1675, Galveston, Texas 77553-1675

processes. Both natural and man made shoreline changes can be good or bad depending on whether or not the change induced effects are in the viewers' favor.

The boundary of the Galveston shoreline facing the Gulf of Mexico starts from the intersection of State Highway 124 with Highway 87 at High Island, and ends at San Luis Pass. This shoreline has a general northeast-southwest orientation approximately 60 miles long. Within this stretch of shoreline, there are two natural tidal inlets, Galveston Bay entrance and San Luis Pass, and one man made inlet, Rollover Pass. These inlets are separated approximately equidistant from each other, and all are connected to Galveston Bay. Rollover Pass and Galveston Bay inlets are regulated by structures, San Luis Pass has no regulating structure.

Weather plays an important role in the physical makeup of the shoreline. The history of a location, especially data on shoreline parameters, provides guidelines to the understanding of the site's adjustments to natural forces. Understanding how a shoreline responds to these forces and taking into account all planning and design considerations will lead to an overall view of the location's attributes, therefore opening the door to solving the area's problems.

The prevailing winds are mostly from the south and southeast directions with a speed of up to 15 knots. There are about 15 to 20 northeasters with speeds up to 50 mi/hr passing through this region during winter [1]. In the past century, there have been numerous hurricanes within a 200 mile radius of Galveston. Hurricane Carla in 1961 produced the greatest storm surge on record in the region [2]. High water levels greater than 5 feet can occur once every two to three years [2].

The astronomical tides vary between diurnal and semi-diurnal and are less than 2 feet. The wave climate in this area is generally mild, heights less than 2 feet half of the time. The average magnitude of longshore current is 0.8 ft/sec southwest 56% of the time and 0.67 ft/sec northeast [1].

The general characterization of the Galveston shoreline takes into account the effects of location and natural forces on each of the individual areas, while trying to present an overall view of the region. Since the Galveston region is broken into eight (8) different problem locations, there would be eight different problems to be solved. The key for stabilizing, thereby solving, the shoreline problems is to investigate each individual location and the effects that it has on the other locations.

The Galveston shoreline comprises of two main problems; erosional tendencies and unwanted accretion. Erosion problems occur near the High Island, Rollover Pass, and Galveston west beach, while unwanted accretion may be found in Rollover Bay, Big Reef, and Galveston West Bay. Structures are present and occupy the middle section of County's shoreline. The relationship of all these problem areas need to be investigated, and an overall regional understanding will provide answers to the coastal shoreline problems. The Galveston shoreline can be broken into four major areas for general characterization, as shown in the following figure.

# Galveston Shoreline Characteristics

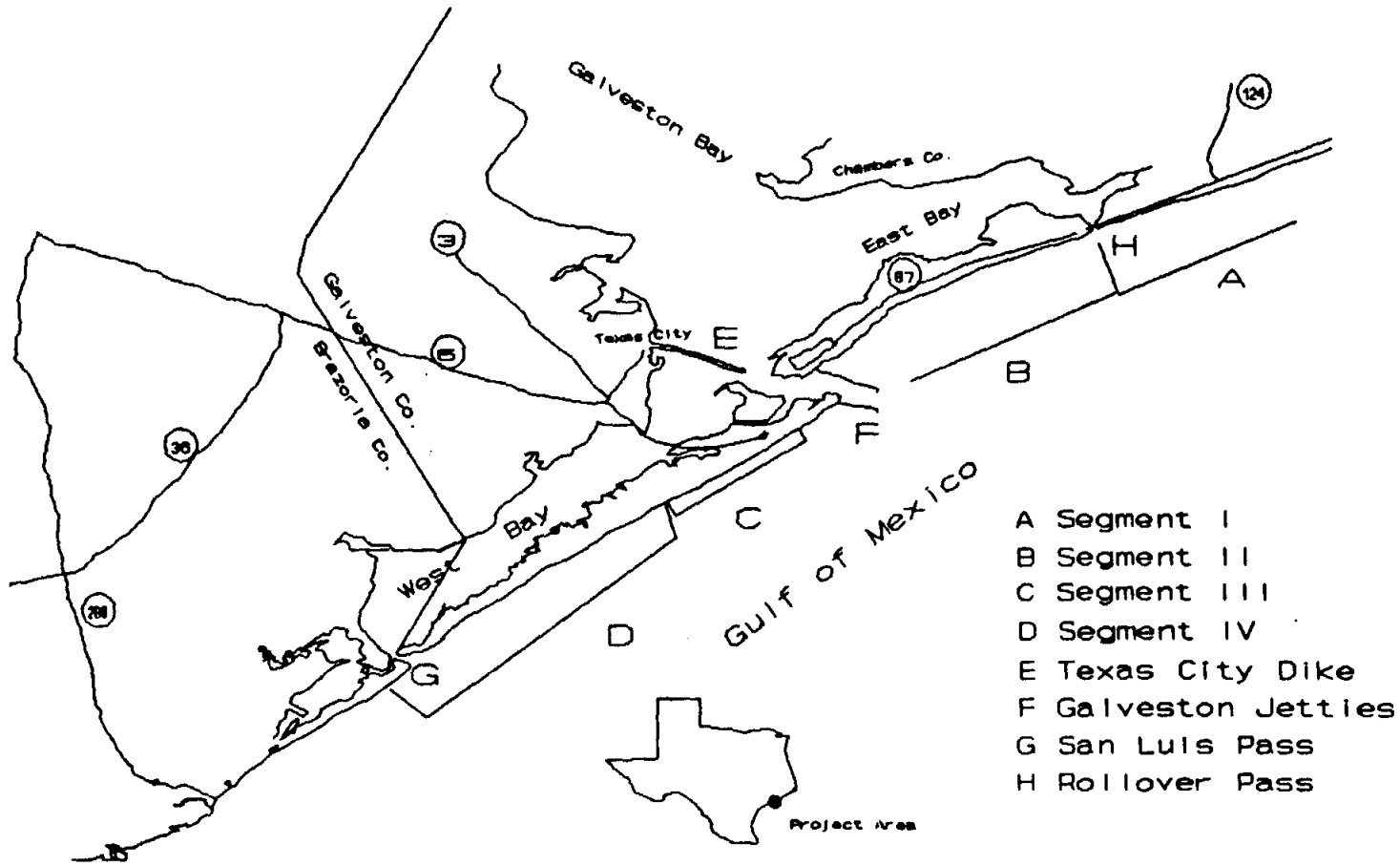

- A Segment I
- B Segment II
- C Segment III
- D Segment IV
- E Texas City Dike
- F Galveston Jetties
- G San Luis Pass
- H Rollover Pass

Segment I: Location of this portion is the extreme northeast boundary, High Island to Rollover Pass. East of this segment is Sabine Pass and adjacent coastline that serves as a sediment supply source. Rollover Pass, southwest part of segment, serves as a sediment sink. This segment's shoreline is relatively straight with a northeast orientation.

Segment II: This portion is from Rollover Pass to the Galveston Bay entrance. The north jetty serves as the boundary, forming a discontinuity of longshore transport. The shoreline orientation is slightly concave towards the south due to the accumulation of sediment on the north side of the jetty.

Segment III: This area takes into account the Galveston Bay entrance to the west end of Seawall Boulevard. This segment has its littoral processes modified by man made structures. Sediment discontinuity occurs at the south jetty, then is influenced by the groinfield and seawall. Shoreline orientation follows the structures, with little beachfront being present.

Segment IV: This portion contains shoreline from the end of the Galveston Seawall to San Luis Pass. This segment encompasses 18 miles of natural sandy beaches with residential communities intermittently developed along the shoreline. The southwestern end, San Luis Pass, marks the boundary of the Galveston coastline, and serves as a sediment sink.

The following are the individual projects within the Galveston region. Each has its own problems which, by the will of the public, need to be solved. These problems will be investigated and a solution will be given, along with options, in order to stabilize the shoreline.

# Bolivar Peninsula Ferry Landing

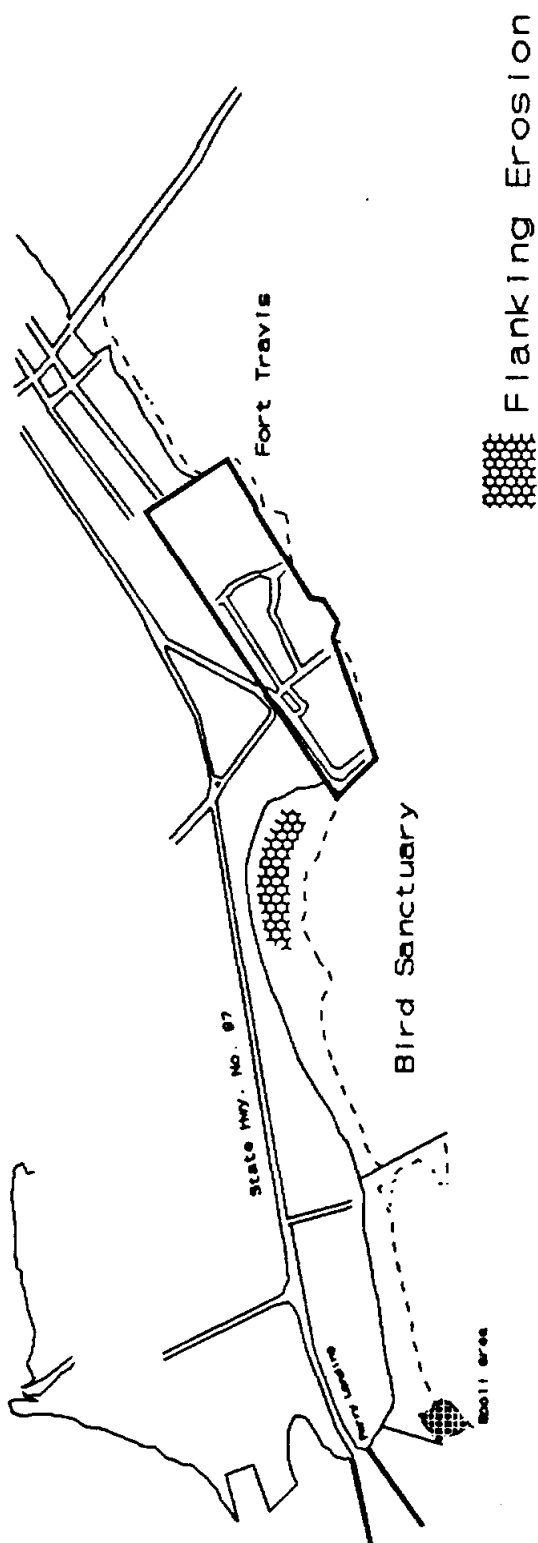

Handwritten marks on the right margin, including a large 'J' at the top and a '1' at the bottom.

## **SHORELINE EROSION ALONG BOLIVAR PENINSULA**

There are three problem areas along Bolivar Peninsula, the shoreline between High Island and Gilchrist, Rollover Pass, and the road at the ferry landing. Problems at Rollover Pass and vicinity are complex and will be treated separately in the next section.

### **SHORELINE BETWEEN HIGH ISLAND AND GILCHRIST**

**THE PROBLEM AND ANALYSIS:** The beach between High Island and Gilchrist is narrow. The waterline is close and parallel to State Highway 87. During severe storms this stretch of highway becomes inundated becoming vulnerable to washing out. The narrow beachfront and closing-in waterline is not an isolated phenomenon, a typical erosional scene is found along the shoreline between Sabine Pass and High Island. Some stretches of Highway 87 is closed to traffic along this section.

**THE OBJECTIVE AND SOLUTION:** The single objective is to stop shoreline erosion. Since the problem is not isolated, it must be solved as a part of the bigger problem area from High Island to Sabine Pass.

### **ROAD AT FERRY LANDING**

**THE PROBLEM AND ANALYSIS:** The shoreline erosion immediately after the ferry landing piers on Bolivar Peninsula threatens the integrity of the ferry landing road. The possible cause of the problem may be due to tidal currents interacting with the seawall, in place at Fort Travis, causing flanking erosion. Naturalists have suggested making the shallow water regions between the ferry landing and north jetty a bird sanctuary.

**OBJECTIVES:** Stop the advancement of flanking at the ferry road location without interfering with the shallow water bird sanctuary.

**OPTIONS FOR ATTAINING OBJECTIVES:** There are two ways to protect the ferry landing road; use of soft approach and hard structure. In this case the hard structures are preferred over the popular trend of soft approaches for the following reasons.

The softer approach is to fill in the eroded area (approximately 25 acres in size) periodically in cooperation with the annual dredging schedules of the ferry landing piers which amounts to 200,000 cubic yard per year. The major drawback to this option is the reduction of shallow bay area by filling-in with materials. State and federal agencies and environmental groups have all expressed their concerns.

Armoring is another option. The placement of a seawall or rubble mound revetment can be implemented. There are new designs of armoring units for absorbing and dissipating wave energy. These designs are aimed to replacing the vertical bulkhead/seawall in sheltered areas, which may be worth looking into. This type of armoring will be compatible with the Fort Travis shoreline and does not interfere with the natural bird sanctuary.



A groin system with proper design of length and spacing can also serve the function of stabilizing the shoreline without reducing the shallow water bay bottom area.

A detached small breakwater segment parallel to the waterline to encourage accretion in the eroding area through natural processes is another option can be worked out.

Finally, the use of the concept of a "feeder beach" could solve both the eroding shoreline problem at the ferry landing road and the silting problem at the ferry landing piers. This may be done by locating a feeder beach site on which the dredging material from the ferry landing piers may be placed and these materials are then distributed by waves and tidal current to the eroding area along the ferry landing road.

## ROLLOVER PASS

Rollover Pass was originally constructed by the U.S. Army Corps of Engineers in an effort to create a marine nursery ground in unproductive waters of Galveston East Bay. Ever since the man made cut was open, middle 1950's, excessive erosion has occurred on the downdrift and updrift sides of the cut. Rollover Bay is choked with massive sediment deteriorating the water quality. A comprehensive plan using an integrated system approach was proposed by Wang in "*Preliminary Designs of Improvements at Rollover Pass and Vicinity, Bolivar Peninsula, Texas*" [3].

Galveston Seawall Vicinity

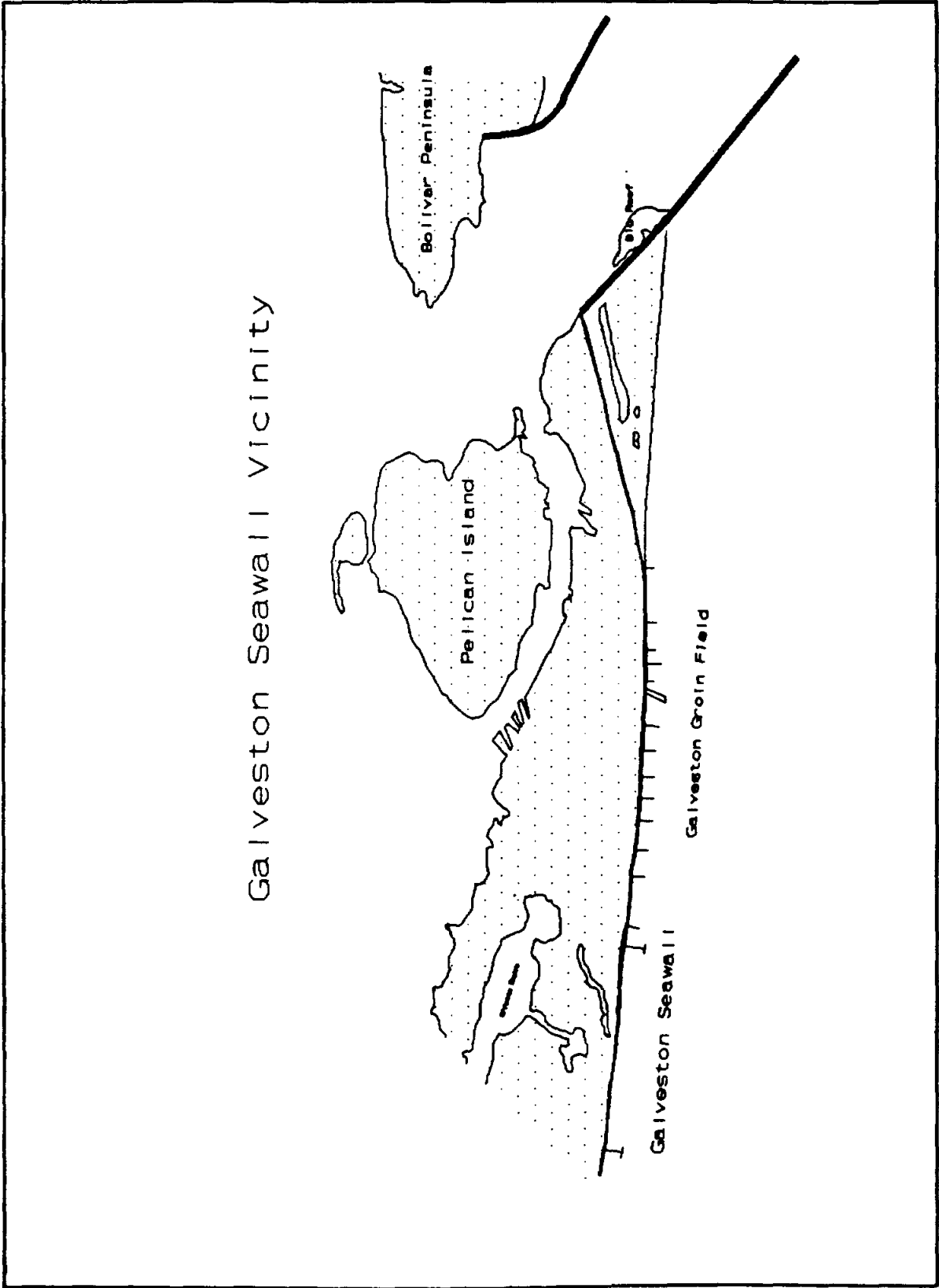

## **GALVESTON SEAWALL AND GROIN FIELD**

Construction of the Galveston Seawall started in 1902 and now extends 10 miles. The groin field was constructed between 1936 and 1939 with the final configuration completed during 1968-70. The groin field occupies a seawall segment approximately 4.5 miles long. The main purpose of the seawall is for protection of the uplands behind it. The construction of the groin field is for stabilizing the shoreline by impeding littoral sand movement for protection of the seawall foundation. Both structures serve their intended purposes well. In the mean time, however, the degradation of beach in front of the seawall occurs. Today there is no appreciable recreational beach in front of the seawall.

At present, the shoreline along the seawall appears stable, although waves directly pounding at the seawall are observed during rough weather. The integrity and safety of the existing seawall structure must be calculated since the investment of the structure, property, and life behind it is great. This cannot be taken lightly. Suppose a hurricane with the strength of "Hugo" directly hits Galveston Island. This hurricane may produce storm surges in excess of 20 feet with waves of 16 feet in height directly pounding at the seawall, causing scour of the structure toe. The ability and current conditions of the concrete slab and riprap aprons at the structure toe to withstand this scouring power is of interests to coastal engineers.

**OBJECTIVES:** The primary objective is to restore the beach in front of the Galveston Seawall. A secondary objective is to provide an extra measure of safety and integrity for the seawall under extreme conditions.

**OPTIONS FOR ATTAINING OBJECTIVES:** Beach nourishment is the most popular shoreline restoration and protection method in the United States. It has been widely adopted along the Pacific, Atlantic, and Gulf of Mexico shorelines. This method allows the designer to provide desired beach width, berm elevation, and beach slope. The results are immediate and impressive. Since the objective is to restore a beach along the seawall for recreational purposes, beach nourishment is the only method that can deliver prescribed beachfront dimensions quickly.

The general technical information on the planning and design details regarding a beach nourishment project may be found in the previous progress report. The following is site specific information that the engineer should take into account in addition to the design considerations given previously. This information is by no means exhaustive.

- \* Assume the project length will cover the full length of Galveston Seawall. The end conditions of the project area will dictate the behavior and movement of new sand used in the beach nourishment project.
- \* The continued growth of Stewart Beach, East Beach, and the Big Reef, along with the siltation of San Luis Pass and Galveston West Bay are observable. These phenomena suggests that there is no strong predominant littoral transport direction along the Galveston shoreline. The magnitude and direction of the

longshore currents in Galveston coastal waters suggests that the direction of longshore sediment transport is reversible.

- \* After beach restoration is completed, it is expected that Stewart Beach, East Beach, and the Big Reef will continue to grow at a faster rate while the erosion rate along Galveston's west beaches will be slowed.
- \* The Galveston Bay South Jetty and the ship channel at the northeast end of the proposed project area form a discontinuity of littoral transport. While the boundary condition at southwest end of the project area allows the littoral material to move with little obstruction.
- \* Valuable lessons have been learned from the pilot (mini) beach nourishment project that took place in front of the San Luis Hotel during the Spring of 1985. Sand was trucked in from the east end of the island and dumped in front of the seawall between the groins. This pilot project provided clues on design berm elevation, design slope, overfill factor, erosion modes and rates, and the interaction between groins and the new sand. Unfortunately, the project was not well planned nor monitored to yield accurate scientific data for engineering planning and design purposes.
- \* Data from the monitoring of the pilot project follows [4].
  - ~ The monitoring period was 17 months
  - ~ The native beach grain size ranged from 0.10 to 0.42mm
  - ~ The borrowed sediment grain size ranged from 0.08 to 0.15 mm
  - ~ The borrowed volume was 11,460 cubic meters
  - ~ The shoreline retreated 52 meters in 17 months
  - ~ 16% of filling material was lost in 17 months
  - ~ Losses of beach material were due to: (i) movement to offshore, (ii) end losses, (iii) profile adjustment, and (iv) eolian transport.
- \* The end losses at groins which confined the dumped nourished sand indicated that the design berm elevation should not be much higher than the storm berm elevation in order to reduce the unwanted losses.
- \* The eolian transport is significant in the pilot project. If the width of newly nourished beach is to include a parking strip along the seawall base, the eolian transport must be carefully considered.
- \* The monitoring program indicated a 52 meters of shoreline retreat in 17 months. This high rate of shoreline retreat needs to be reduced. Further study of options for reducing the shoreline retreat rate is highly recommended.

A groin field alone may not be able to attain the primary objective since a groin field is already in place over the middle 4.5 miles of the Galveston Seawall. The existing groin system has variable lengths and spacing between individual elements. If a new groin field is chosen for trapping longshore drift and building a beach, the groin cross-section, groin length, and spacing must be checked and re-calculated.

On the nontechnical aspect, to many individuals, a groin field is not eye pleasing due to the crescent shape and segmentation of the beach.

Among the established methods of shore protection, the offshore breakwater is the one that could be used to protect as well as widen a beach. Projects that employ an offshore breakwater can be found on both the Pacific and Atlantic coasts. The planning and design criteria are given in the previous progress report. Site specific information pertaining to the project area are similar to those eluded earlier, namely, littoral sediment transport characteristics and boundary conditions.

The south jetty cuts off the sediment supply to this region, the littoral transport in front of the seawall is one way from west beach to the South Jetty. The littoral movement in the reverse (southwest) direction carries little material since the groin field is empty. Installation of offshore breakwater can slow down this mainly one way traffic of sediment movement. This would allow the littoral sediment to deposit on the beach in front of the seawall, and to reduce the growth rate of the Big Reef.

Other nontechnical matters equally important in the processes of choosing offshore breakwater as a shoreline protection method are: (i) general public perception of soft versus hard structures and (ii) boating and recreational concerns, although no persistent hazardous situations have been reported in existing offshore breakwater locations.

The price of sand is soaring. The initial investment funds, subject to legislative vote and public referendum, are large. The fast rate of shoreline retreat after nourishment is reported by the mini pilot project at the San Luis Hotel. This provides an incentive to find ways to keep nourished sand on beaches longer.

As to economic considerations, the groin field is already in front of the seawall, to utilize these existing materials for protecting the nourished beach and seawall is natural. In addition, the shoreline and the groin field in front of the seawall have been relatively stable over the years. For these reasons one would logically consider the option of combining beach nourishment with an updated groin field as a means of keeping the sand on the beach longer. Although the beach in front of the seawall is fairly stable, it did not trap the sand to form a beach there.

Whether the combination of nourishment and breakwater will be chosen depends on (i) economical analysis, (ii) the tolerance of hard structure to the soft approach for shoreline stabilization, and (iii) the offshore breakwater being less of an eyesore and not segmenting the beach as a groin.

Of the six major new technologies the dune restoration method does not apply for this case. The beach drain system would not work due to the absence of beach to be drained. Both the dredge material placement technique and the subbottom profile manipulation method have inconclusive results. This leaves only the littoral drift manipulation as a possibility.

The Galveston Bay south jetty cuts off sediment supply at the northeast end of the project area. This renders a one way littoral transport direction toward the northeast. As a result, East Beach and the Big Reef continue to grow and the southwestern portion of the project area experiences a deficiency of sand causing the west beaches to have an erosional trend.

The littoral drift manipulation technique may be employed to slow down the one way littoral transport in the project area, thus, stabilizing the beach in front of the seawall and slowing down the erosion occurring on west beaches. The test project in Miami which employs T-groin and heavy sand has a similar physical setting as Galveston. A close watch on the progress of this test project may aid the decision process for selection of shore protection methods for Galveston.

The choice of the plain beach nourishment method should consider the re-nourishment period. An updated groin field would perform better than the existing groin field, although not by much, unless a completely different system aimed to control direction of littoral drift is employed. The offshore detached breakwater has proven its characteristics of protecting as well as widening a beach, but since it is a hard structure, many consider it an eyesore and/or safety hazard.

The combination of soft and hard structures has merit of keeping sand on beaches longer. This choice should be determined by economical feasibility analysis.

The emerging new technologies are still in their infancy. It would not be good for the first demonstration of these to be implemented in Galveston. This area has suffered and needs proven projects to be employed. It should be encouraged to test some of the new methods, elsewhere, and to initiate new methods of our own at a later date. This would be a necessary condition to elevate the State of Texas to leading position in Coastal Zone Management.

# Flanking Erosion at West End of Seawall

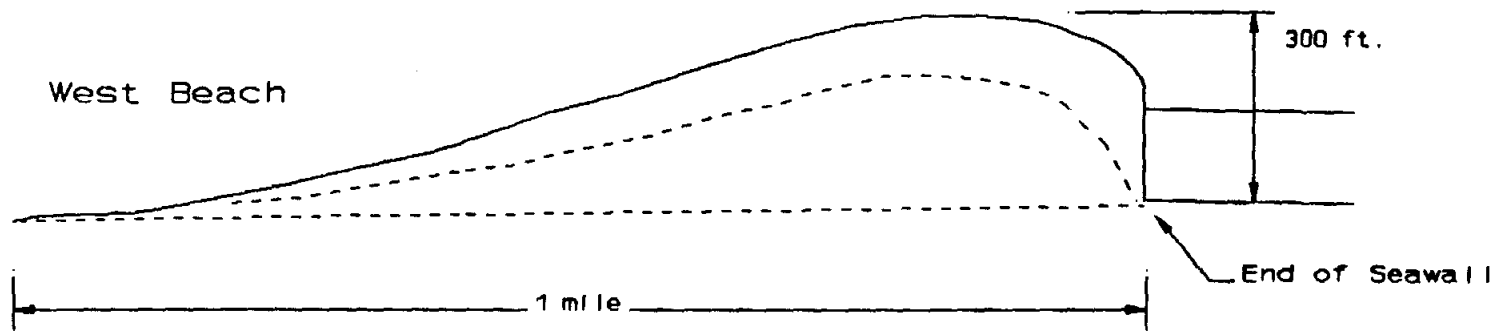

Gulf

## WEST END OF GALVESTON SEAWALL

The erosion at the west end of the Galveston seawall is a typical scene of hard structures parallel to the shoreline. This erosion is known as *flanking*. During severe storms State Highway 3005 will become inundated at the west end of the seawall. Since the highway is so close to the water's edge, citizens on the western portion of Galveston Island fear that they may be isolated from the city if the road is washed out at end of seawall.

**OBJECTIVE AND SOLUTION:** The single objective for this problem area is to stop the flanking at the west end of the seawall. There are a few options available described by the following.

A soft approach to the problem is beach nourishment of the eroded area and prevention of flooding by re-establishing a dune line. Periodic renourishment with high frequency would be anticipated for this method.

A more permanent solution with infrequent and minimum maintenance is to use an offshore detached breakwater. With proper design of top elevation, permeability, length of structure, and distance offshore, a smooth shoreline which would bridge the seawall and natural beach is achievable. Similar situations are found in Santa Monica and Channel Island shorelines in California. Records of the shoreline evolution at these two locations are shown on the next two pages. These pictures provide a clearer view on the offshore detached breakwaters work.

Other options include a formation of a transition shoreline bridging the seawall and natural beach. This transition may consist of a series of groins with reduced lengths stretching out towards the southwest from end of seawall.



## Santa Monica Offshore Detached Breakwater

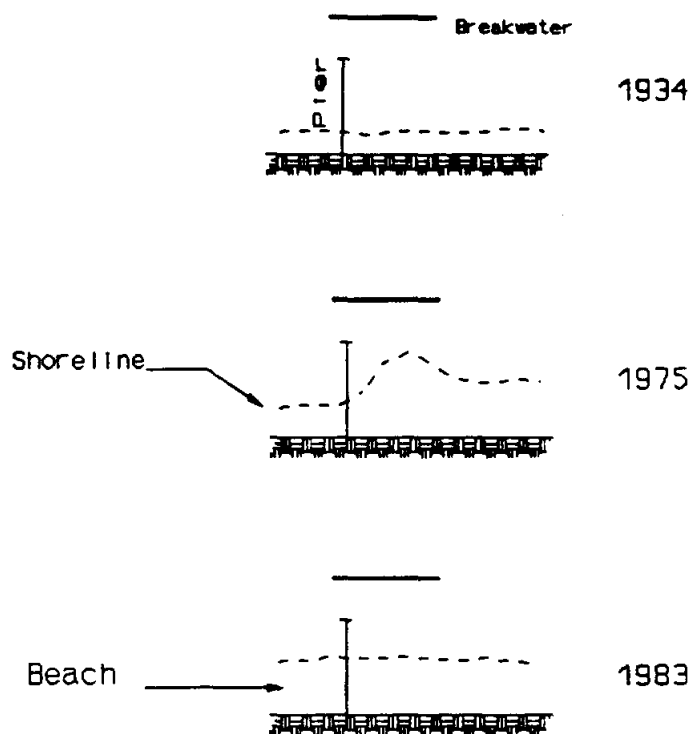

Type: Rubble mound  
 Length: 2000 ft.  
 Top Elevation: 10 ft. above MLLW  
 Distance Offshore: 2000 ft.

In 1934, when the breakwater was constructed, there was insignificant beachfront present. In the 1960's beach width increased to 800 feet wide. Due to lack of maintenance, the breakwater has slumped over the years. In 1983 the breakwater's top elevation was 6 ft. below MLLW, allowing for an increase in wave energy. This increase has since reached an equilibrium state, providing a smooth and stable beachface.



Channel Islands, California

The above two figures are aerial photographs of Channel Island, California. The top picture, taken in 1965, shows the eroded beach behind the breakwater. The lower picture, taken in the 1980's, shows the formation of a tombolo in the lee of the breakwater. The breakwater information follows:

Type: Rubble mound  
Top Elevation: 14 ft. above MLLW  
Length: 2300 ft.  
Location: 30 ft. bottom contour

The Santa Monica and Channel Island breakwaters indicate the possibility of designing an offshore detached breakwater that allows just enough energy to leak in its lee so that a smooth and stable shoreline is produced.

## **GALVESTON WEST BEACH**

The major problem facing Galveston west beach communities is the retreat of shoreline causing flooding of property during storms. The narrowing of the beach face is also a concern. The west beach problems are categorized: failure of beach accretion, presence of low lying areas, and little protection from storm surge. These three problems will be discussed, along with possible solutions, while keeping in mind the interrelationships of each.

The Galveston south jetty and empty groin field along the seawall provides no sediment supply to the west beach region. Also, the shoaling of San Luis Pass and Galveston west bay indicates a sediment sink providing no sediment. These two boundary conditions set the general erosional trend for the west beach. The west beach of Galveston Island has no appreciable accretion. Large volume of littoral material bypasses the beachfront, continuing downcoast towards San Luis Pass (see San Luis Pass). This has caused numerous problems along the coastline which will be discussed later. Failure of West Beach to build itself, through accretion, has taken away the protective buffer zone that is needed during storm episodes. The *Shore Protection Manual* [5] states that a beachfront buffer zone is one of the best defenses against coastal property loss.

The relationship of upcoast structures, jetties, groins, and seawall, with littoral transport needs to be established so that when these are solved an accretion process can be started at West Beach. While the city has a seawall, the west end is left unprotected from storm surges.

**OBJECTIVES:** The objectives are to stop coastal land loss, prevent flooding of uplands, and widen the beach face for recreational use.

**OPTIONS FOR ATTAINING OBJECTIVES:** Use of beach nourishment with dune restoration. An initial beach restoration project is needed to establish a sound shoreline. However, beach nourishment alone can not stop flooding of upland and coastal land losses. The sea level rises during a hurricane, the nourished beach will be submerged under the stormy sea surface. The storm sea level allows the wave to attack higher coastal land and is one of the major causes for land loss, flooding, and property damage. The proper remedial method is to build the duneline before a storm attack. During a storm, the dune line takes the brunt assault of storm and absorbs the destructive energy in order to save the land and property behind it. After the storm, the duneline is quickly restored ready for the next storm. A cost effective with minimal environmental impact method for dune restoration is proposed by Wang called *Nature Assisted Dune Restoration (NADR)* [6]. The raising of land areas by dune restoration, and the implementation of a buffer zone through beach nourishment will stabilize the shoreline and reduce the storm surge damage on coastal property and land.

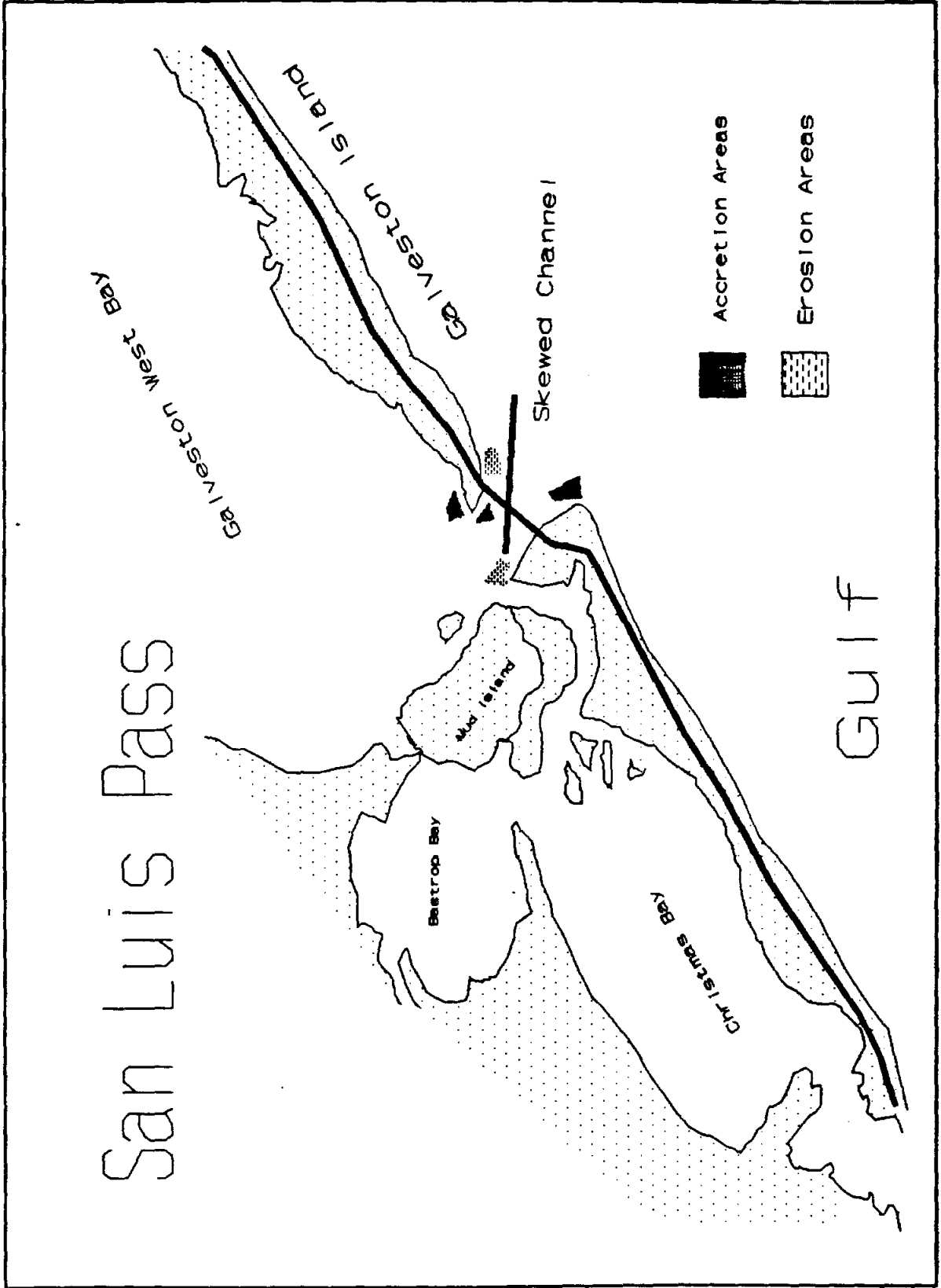

## **SAN LUIS PASS**

The recent trend occurring along the western extreme of Galveston Island, San Luis Pass, is that of unwanted massive accretion and erosion along the Pass. These in turn have created the re-alignment of the channel which has skewed toward the northwest direction. It is shown on the San Luis Pass map.

It is observable, the bridge which spans the inlet has a beachfront below; the channel has become narrower and deeper. A stronger tidal current is thus produced and it undermines the bridge piers and erode the shoreline along Mud Island.

The nearby Galveston West Bay area have been filling with sand, circulation of bay waters have been interrupted and the healthiness of bay related businesses have suffered. Solutions to the massive deposit of littoral materials need to be found.

**OBJECTIVE:** The multiple objectives should include:

- \* Stabilize the skewed channel which runs through the Pass.
- \* Revive the smothered bays by restoring the flashing and circulation of the inlet-bay system at San Luis pass.
- \* Control the sediment movement along the shoreline to reduce the rapid siltation of the inlet-bay areas and the erosional trend at the Gulf shore near the Pass.

**APPROACHES TOWARD ATTAINING OBJECTIVES:** The San Luis Pass serves as a vital link which connects Galveston West Bay, Bastrop Bay, Christmas Bay and Chocolate Bay. The circulation and flashing pattern of this inlet-bay system is directly related to the well being of the ecosystem in that region. Therefore, a comprehensive system approach toward a solution is recommended. A report similar to the study of Rollover Pass and vicinity is called for [3]. The study should include but not limited to the following.

- \* Effects of upcoast and downcoast characteristics on the inlet-bay system.
- \* Impact of man made shoreline protection measures on the inlet-bay system.
- \* If sand removal from the inlet-bay system is necessary for revive the choked system, then, this removal should be taken into account for replenishment supplies for beach nourishment projects along the seawall and Galveston west beach.

## **TEXAS CITY DIKE**

The Texas City dike opens to a fetch length of approximately 30 miles in the north northeast direction. A northeaster with a wind speed of 50 miles per hour blowing for 3 hours could produce waves in excess of 5 feet high. These waves break against the dike may cause scour at the structure toe as well as dislodgment of armoring units. It seems prudent to send divers to inspect the foundation before any preliminary solutions can be formulated. Once the nature of damages is known, maintenance and repair procedures can then be suggested.

The shoreline between the Dollar point and Tide Gate has the same orientation as the Texas City Dike, therefore it subjects to similar wave actions. Shoreline condition there may need more attention than the Texas City Dike.

## **GALVESTON BAY SHORELINE EROSION**

The major problems facing the shorelines of Galveston Bay is erosion in shallow waters.

**SOLUTIONS:** Solutions to shoreline erosion in Galveston Bay consists of different employments of material to dampen waves. Vegetation is a natural dampener. As a wave approaches shallow water areas with vegetation (usually grasses) it dissipates energy. Another type of dampening can be employed by man-made materials. The use of man-made materials would serve better than vegetation in that the energy can be calculated and dampening can be implemented to varying degrees. The use of structures with specific shapes and characteristics can be refined to control the energy that waves will possess.

## **CONCLUSIONS**

The problem area on the shoreline of Galveston County are identified. Analyses of the problem areas are done in the light of the physical environment and littoral characteristics of Galveston coast line. Optional methods for protecting the shoreline in each problem area are suggested. The selection process for a protection method in a problem area begins with the economic analysis. Data acquisition is expensive and time consuming. At the planning and preliminary design stages, it is adequate for engineers to use available historical data. For long term considerations, a plan to collect and establish a data base for Texas Coastal Zone Management and Galveston County is very much needed. The final decision should be weighed with technical merit, environmental concerns and economical soundness.

## ACKNOWLEDGEMENTS

Special thanks to Mr. Ronnie Barcak, a senior engineering student, who has devoted many hours working on this paper. His work included reading, editing, and typing of the manuscript, along with producing the engineering drawings found in this report. His participation and dedication on this paper is especially acknowledged and appreciated.

The financial supports provided by the Texas Water Development Board and Galveston County through Dannenbaum Engineering Corporation are gratefully acknowledged.

## REFERENCES

1. US Army Corps of Engineers (1984) "Galveston county Shore Erosion study. Feasibility Report on Beach Erosion control; Vol. 2: Gulf Shoreline study Site Report," US Army District, Corps of Engineers, Galveston, Texas. p. 185
2. Morton, R.A. (1975) "Shoreline changes Between Sabine Pass and Bolivar Roads: An Analysis of Historical Changes of the Texas Gulf Shoreline." Geological Circular 75-6, Bureau of economic Geology, the University of Texas at Austin, Austin, Texas.
3. Wang, Y.H. (1989) "Preliminary Designs of Improvements at Rollover Pass and Vicinity, Bolivar Peninsula, Texas." Technical Report, MASE Department, Texas A&M University at Galveston, p.156
4. Giardino, J.R., Bednarz, R.S., Bryant, J.T. (1987) "Nourishment of San Luis Beach, Galveston, Texas: An Assessment of the Impact." Coastal Sediments '87, pp. 1145-1157
5. US Army Corps of Engineers (1984), "Shore Protection Manual" Coastal Engineering Research Center, 2 Volumes
6. Wang, Y.H. (1991) "Nature-Assisted Dune Restoration" Proceedings, Coastal Zone '91, Long Beach, California

**PROPOSAL FOR IMPROVEMENTS TO ROLLOVER PASS  
BOLIVAR PENINSULA, TEXAS**

**Darrel K. Pelley\***

**Based on an Initial Study Performed in December, 1989 by:**

**Dr. Y.H. Wang, PhD  
Miles F. Gathright  
Nicholas G. Kyprios  
Laura L. Robinson  
Michael S. Vickers**

**Michael E. Duncan  
William J. Hoffman  
Darrel K. Pelley  
Mark I. Sales  
Jung Ho Yoon**

**INTRODUCTION**

During the fall semester of 1989, a study was performed by a group of students from the Maritime Systems Engineering department of Texas A&M University at Galveston in an attempt to determine causes and solutions for the erosion problem at Rollover Pass, along the upper Texas Coast. This study was inspired and supported by the citizens of the Bolivar Peninsula, Mr. Eddie Barr, Galveston County Commissioner, Mr. Pat Hallisey, director of the Galveston County Beach Park Board, and Dr. Y.H. Wang, Professor of Engineering at the university.

This report will attempt to summarize the findings and suggestions of the study and outline the proposed suggestions made for improvements to be made in the area.

---

\* Naval Architect, Waller Marine, 15311 Vantage Pkwy, Suite 250, Houston, Texas 77032



## PROBLEM DISCUSSION

The Rollover fish pass was initially opened in 1954-1955 by dredging a small channel measuring 80 feet wide and 8 feet across through a narrow section of the Bolivar peninsula where the maximum land elevation did not exceed 5 feet above sea level. Instability soon caused the channel to scour to a width of 500 feet wide at the seaward mouth, with water depths of 30 feet in some locations (Ref.1: p.429). In an effort to maintain the structural integrity of the Texas highway 87 bridge crossing the pass, the channel was closed by driving a line of steel sheet piles across its width on the seaward side of the bridge. The pass remained closed for the installation of steel sheet piles along both sides of the pass and was again reopened in 1959-1960. The sheet piles blocking the channel were driven down to a depth of approximately 5 feet below mean sea level (MSL) (Ref.1: p.429) and form a trapezoidal weir to seaward of the bridge and intended to protect the bridge foundations. In the years since the reopening of the pass, accelerated erosion has threatened the property of residents, and highway 87, several sections of which have already been closed between High Island and Port Arthur, Texas.

## STUDY JUSTIFICATION

Since the reopening of the fish pass, erosion rates along the gulf coast in that region vary considerably. According to the U.S. Army Corps of Engineers (USACOE), the average annual beach loss in the vicinity is 14 to 16 feet. A comparison of USACOE data and numerous other studies is shown in Table I. Analysis of the data reveals the erosion rates for the southwest side of the pass exceed those for the northeast side by about 2 feet per year on average. The table data is based on a linear distance of 6,900 feet to either side of the pass. The 1984 study conducted by the USACOE concluded the annual quantity of sand lost on the down drift measured area to excess beach erosion was approximately 9000 cubic yards. Additionally, it can be noted that USACOE estimated erosion rates since the opening of the pass have exceeded the pre-pass erosion rates by 3 to 12 feet annually.

In addition to determining how much sand is lost in the area annually, it is necessary to investigate the final destination of displaced littoral material. Visual inspection of the bay area adjacent to the pass on Friday, 20 October 1989 during the ebb tide showed a large percentage of the bay bottom completely exposed. Tidal data for the same day provided by the U.S. Department of Commerce (USDOC Chart 11331-SC) shows a low tide of 0.0 feet above MLLW at 2:39 pm. Evidently, severe sedimentation has occurred in Rollover bay over the past three decades due primarily to the flood dominant characteristics of the inlet. Additionally, it was noted by the design team that maintenance dredging rates for the Gulf Intracoastal Waterway (GIWW) in the area have increased since 1959-1960 when the pass was reopened. The erosion loss data, GIWW maintenance rates, and visual inspection results led directly to a hypothesis that the littoral material disappearing from the beaches along the northeast side of the pass were being deposited in the adjacent bay, while scouring effects on the southwest side of the pass were causing materials to be moved along the coast and redeposited on the east side of the Galveston-Houston entrance.

## **GALVESTON BAY CLIMATOLOGY**

The climate characteristics for the Galveston Bay system including Rollover pass are compiled below in tabular form and are based on statistical information gathered by the design team during the initial phase of the study in December, 1989. The parameters used in the design processes are directly related to the information below:

### **ANNUAL RAINFALL**

The Texas Gulf Coast climate is generally characterized by long, hot summers and relatively short, mild winters. Annual rainfall for the region averages approximately 45 inches. The recorded annual rainfall has a direct effect on the salinity regimes in the East bay system. The east and Rollover bays are fed by tributaries, including the Trinity river and the east bay bayou. The occurrence of long, dry periods corresponds to a slight increase in baseline salinity due to the inability of salt crystals to be evaporated.

### **WIND CHARACTERISTICS**

Wind conditions in the western Gulf of Mexico are characterized by wind velocities of 8 to 15 miles per hour from the south-southeast for more than 60 percent of the year. As a result of these predominant conditions, alongshore littoral transport is generally from east to west. Each year, 15 to 20 fast moving polar fronts pass through the area bringing northerly winds at velocities of up to 50 miles per hour. The period preceding the passage of a front brings strong southerly winds, generating stronger than usual wave activity in the area.

### **WAVE PROPERTIES**

According to the U.S. Army Corps of Engineers (1984), wave heights in the area exceed 4.5 feet only 1 to 3 percent of the time. Wave heights of 2 feet or less occur 25 to 50 percent of the time. Wave conditions in the region can therefore be described as relatively calm.

### **STORM ACTIVITY**

During the period from 1900 to 1984, twelve hurricanes made landfall within 40 miles of Rollover pass. The greatest surge height was recorded in 1961 during hurricane Carla, which came ashore 150 miles southwest of Rollover pass (USACOE 1984). On average, surges greater than 5 feet have occurred in the locale every 2 to 3 years. This erratic storm activity can result in significant beach profile changes.

## PROPOSED SOLUTION

It was decided as a direct result of the preliminary research conducted by the group that the solution would consist of three (3) major phases; initial beach nourishment, design and construction of a jetty system at the pass to interrupt the littoral flow of material down the coast, and secondly, implementation of a sand bypass plan to periodically replenish the beaches on the down-drift side of the pass.

## BEACH NOURISHMENT

Because of the badly deteriorated beach profile, it was decided that a short term alleviation of the local erosion problem had to be found in order to build the permanent structures and allow the long term program to go into effect. This first phase is to be accomplished in the form of beach nourishment. Simply stated, the beaches would be nourished with borrowed sand, stabilizing the beach profile during the construction phase. In order to implement such a plan, it became necessary to find a suitable borrow site, where the grain size closely matched the assumed grain size missing from the beaches around the pass. On October 20, 1989, members of the design team made core samples from the exposed bay bottom at several locations in the bay during slack water between the ebb and flood tides. After sorting the materials according to grain size, it became apparent that a substantial amount of the material sampled in the bay was compatible to the material missing from the beaches. The results of the grain analysis seemed to provide some evidence that the flood dominant characteristics of the pass were causing littoral material to be drawn into the bay during the flood tidal cycles, choking the bay bottom. The amount of material required for the initial nourishment was calculated based on the following parameters:

1. The 4 mile stretch of nourished beach would have a berm at least 100 feet wide at the completion of the operation.
2. The nourishment would establish a dune line at least 7 feet high running continuously along the entire stretch of beach.

It was decided for cost effectiveness to use a shoreside dragline dredging system to remove 188,000 cubic yards of sand from the bay bottom to the gulf beaches over a stretch extending two (2) miles to either side of the pass. The dredged bay bottom elevation at -3 feet would encourage the formation of wetlands around the fringes of the bay. As the operation moved away from the shore, the dragline would be moved on to a barge and floated into the bay to continue recovery. The recovered material is offloaded to a storage area for drying before being moved by dump trucks to the beach. An alternative method would be to move the material to the beach directly from the barge via a pumping system, although it is assumed that the pumping method would be more costly. The sand is placed on the beach at the feeder beach locations discussed in the by-pass section of the 1989 study and summarized in the by-pass section of this report.

Finally, an attempt to stabilize the dune line would be made through planting naturally occurring dune grasses and allowing them to take over the dune line and effectively anchor the sand in place. Types to be used include Panic Beach Grass (*Panicum amarum*), and sea oats (*Uniola paniculata*).

## JETTY DESIGN AND CONSTRUCTION

The jetty design team was required to select a jetty size and type consistent with environmental conditions prevalent along the gulf coast and a considerable design lifetime. Several types of common jetties were investigated before the final decision was made. Sheet pile jetties were considered for their low initial investment required for construction, and their relative ease of construction. Indeed, sheet pile jetties were constructed along the Galveston Island coast during the 1930's; however, within thirty years, the outer portions were severely damaged and wasted due to corrosion. This same condition can be observed today at Rollover pass where the sheet piles have deteriorated due over the course of time. A concrete sheet pile jetty, a wall with a concrete cap, was considered for its strength and impermeability to corrosion. Such a structure would have to be pre-stressed and cast in place. Additionally, the salt water environment eliminates the use of steel reinforcement. As a result, the structure would be massive and very expensive to construct. Repairs to damaged sections would be costly and difficult to perform.

The jetty type finally selected is the rubble mound jetty with a granite cover layer, very common along the Texas gulf coast, especially along the Galveston seawall. The rubble mound jetty is constructed with a core of quarry stone, finer material being added later to fill the cavities between the large stones and rendering the core sand-tight. The structure is protected by a layer of armor stone. The armor stone, usually granite or concrete must be heavy enough to remain stable against prevalent worst case conditions. Although rubble mound jetties are costly and time consuming to construct, they have a series of advantages not found with the other types:

1. The rubble mound jetty has a normal design lifespan of 100 years based on design environmental criteria.
2. The structure will act as a barrier to prevent the passage of littoral material.
3. Rubble mound jetties are relatively safe against foundation failure and excessive settling.
4. Excessive scour at the toe section of the jetty will be prevented.
5. The required materials are readily available in central Texas.

Following the study of the littoral transport system for the region, it became necessary to determine the required length of the structures. By projecting beyond the breaker zone, it is estimated that 80 to 90 percent of the littoral transport can be blocked. These

parameters relate to a jetty length of approximately 800 feet normal to the beach line at the pass. The extreme outer portions of the jetties protrude beyond the 6 foot depth contour offshore of the pass. In order to prevent excessive scour and foundation failure, it was determined through a survey of the park to space the jetties 550 feet apart, with the shoreside end of each jetty resting at the east and west boundaries of the park respectively. Such a spacing allows the natural wave action to keep the channel open without undermining the jetty foundations.

The design environmental criteria selection is based on collected wave data for the region. The design wave height used is the average of the highest 1/3 of all waves encountered. The calculated value was determined to be 8.9 feet.

The U.S. Army Corps of Engineers Design of Breakwaters and Jetties was used to determine the stability coefficient for the structures. The designers selected a value of 2.0 in order to obtain the most conservative results from the stability equation for the unit weight of the cover layer. With a required unit weight of 160 pounds/cu. foot, stones with weights between 4 and 6 long tons each were selected. A cross section of the proposed structure can be found attached herein. The jetty design possesses the following characteristics, best summarized in tabular form:

1. The crest elevation will be 6 feet above MLW from the beach to the end of the jetty. The crest elevation is limited by the status of the park as a hurricane washover region. The 6 foot elevation will also allow easy access by recreational fishermen at the park.
2. The minimum thickness for the armor layer is to be 3.7 feet, as determined from the USACOE Shore Protection Manual. Parameters include a unit weight of 8640 pounds per stone, one (1) layer.
3. Since the depth of the structure "is less than 1.5 times the design wave height" [USACOE, SPM], the cover layer must extend all the way to the bottom and onto the bedding layer.
4. A toe berm will be constructed at the ends of the cover layer to improve stability of the cover layer against breaking waves.

The resultant jetty system will tend to cause some scouring directly adjacent to the pass to the west. The implementation of a by-pass system as described below will attempt to alleviate the scour effect while nourishing the beaches along the Bolivar peninsula between Rollover pass and the Galveston entrance.

## **SAND BYPASS SYSTEM**

Very simply stated, sand by-passing is the periodic relocation of sand from a natural collection area to a sand depleted area, usually by-passing a cut or inlet. This technology is not new and has been used with success along the Florida coastline. For the purposes of this study, it was decided to investigate the two most common forms of sand-bypass systems and make a decision as to which system suited the particular application. The first option considered was the fixed by-pass system, by which littoral material is moved via permanently installed machinery at the site, including pumps, pipelines and associated power generation equipment. The second option was the mobile or portable by-pass system, by which sand is moved manually, using earth moving equipment rented or leased only for the duration of operations annually. Following is a brief description of each followed by a summary of characteristics used in the design process.

### **FIXED BYPASS SYSTEM**

As mentioned above, the fixed system employs permanent machinery on location to periodically move littoral material from the deposit zone to the depleted area. A preliminary step to the approach is a foundation pedestal which must be engineered into the rubble mound jetty and sufficiently strong to stand up to the elements over the duration of its useful life span. In this case, the pump house would be located on the eastern side of the pass, approximately one half the distance from the extreme offshore end and the beach line. Within the house would be installed the bypass machinery, pumps, powerpacks and other associated equipment. During operation, a boom fitted with a suction hose would be extended from the pumphouse flat over the deposit area. The material would be pumped through the hose and pump to a pipeline running parallel to the dune line down the beach to the west of the pass. The sand-water slurry would be deposited at or near the dune line with the water and small suspended particles returning to the gulf while the larger grains remained on the beach. This system has been used and proven successful along the Florida coast, where beach maintenance is important to the tourist industry. However, such a system would have a price tag of approximately \$2,300,000.00 added to the initial investment of \$4,000,000 for the jetty system. Also considered are the maintenance to permanently installed machinery in a salt environment, manning requirements, and upkeep during dormant periods.

### **MOBILE SAND BYPASS SYSTEMS**

The other alternative considered is the mobile or portable by-pass concept. The major components of such a plan involve the use of rented or leased equipment, paid for and maintained only for those periods during which operations commence. A dragline, or bucket loader will be used to scoop littoral material from the deposit area on the east side of the pass. The sand is to be loaded into dump trucks and transported down the beach to a point approximately 700 feet west of the pass. A bulldozer will spread the material out

into a feeder beach jutting out from the coast. By placing the feeder beach down current from the pass, the sheltering effect of the pass is minimized and the sand is allowed to be transported down the coast via the naturally occurring littoral transport system in motion along the coast. As can be seen from the cost analysis presented in the following section, the actual annual cost for the operation would be approximately \$200,000. The simplicity of the mobile by-pass method allows the plan to be put into effect immediately after the completion of the jetty, as opposed to the time required for the construction of an elaborate fixed pumping system

## COST BENEFIT ANALYSIS

The major obstacle to overcome with the solution proposed by the design team was the cost. Preliminary budget estimates predicted that the initial investment for the jetty construction would be near four (4) million dollars. Note that the budget estimate is based on U.S. dollars effective fourth quarter, 1989. A simple cost breakdown for the construction phase of the project follows below:

### Phase I, Beach Nourishment

1.	Dredging and transportation of recovered material, based on the total cu. yardage to be moved	\$2,250,000
2.	Earth moving equipment	\$ 80,000
3.	Barge and Handling Vessel (Lease)	\$ 72,000
4.	Insurance and Overhead	\$ 360,000
5.	Contingencies and Overhead	\$ 600,000
6.	Vegetation	\$ 70,000

**TOTAL, Phase I** **\$3,432,300**

### Phase II, Jetty Construction

1.	Cover layer stone, 44,000 LT	\$1,100,000
2.	Core stone, 22,000 LT	\$ 400,000
3.	Blanket stone, 17,000 LT	\$ 309,000
4.	Filler stone, 7,000 LT	\$ 136,000
5.	Equipment and Labor	\$1,000,000
6.	Engineering and Design	\$ 100,000
7.	Contingencies	\$ 500,000
8.	Project Management and Supervision	\$ 300,000

Based on the predicted 100 year life span of the construction, the total investment relates to a yearly cost of 38,000 to 40,000 dollars per year. Additionally, the maintenance costs incurred for rubble mound jetties are minimal and would be realized primarily in the case of storm damage repair. Since the costs outlined above are effective for the end of

1989, actual construction costs, including staging, logistics and labor rates may be significantly higher. However, through stabilization of the beach profile, and indirectly, the protection of highway 87, the bay, and the adjacent Intracoastal Waterway, an increase in the tourism industry to the area would be realized, along with increased property values and reduced maintenance dredging in the GIWW along the north side of the bay.

Additionally there is a cost involved in the sand by-pass aspect of the project. The cost involved in maintaining the beach profile is annual and does not decrease after a large initial investment. Rather, the cost of by-passing trapped littoral material is "lost" in a sense, meaning that the benefits realized through implementation are not financial. Below is a projection of the annual cost for material by-pass operations based on U.S. dollars effective fourth quarter, 1989:

**RENTED EQUIPMENT:**

1.	Dragline	\$2.25/cu. yd.	\$146,250
2.	Bulldozer		\$ 5,000

**SHIPPING COSTS:**

1.	Dragline	\$ 2,000
2.	Bulldozer	\$ 1,000

<b>TOTAL:</b>	\$ 154,270
<b>TOTAL INCLUDING 1.15% OVERHEAD</b>	\$ 177,410

As can be seen, there is no required investment for equipment other than periodic rentals when sediment builds up at the eastern side of the jetty system. Over a ten year period from the completion of construction and the implementation of sand-bypass technology at Rollover pass, the total expenditure would be nearly \$10,000,000. Some further study is required to determine the benefits as a function of predicted property values at the end of the ten year period. At the time of the initial study, the low number of permanent residents made benefits difficult to justify, however, the huge expenditure to reconstruct highway 87 further inland or as an elevated roadway far outweighs the investment outlined in this report.

**ENVIRONMENTAL CONCERNS**

With the completion of this project, there would be some effects on the local environment. These are included in an itemized format and based on data collected during the study. Statistical data has also been supplied by the U.S. Army Corps of Engineers, Galveston, Texas.



## VOLUME CHANGE TO ROLLOVER BAY

Since the initial phase of the program requires the removal of material deposited in the bay from the gulf, there will be a volumetric increase to the bay. The average high tide water depth in the bay at present is between 0.5 and 1.0 feet. The dredging phase of the operation is predicted to increase the average depth to three (3) feet. The removal of the material will effectively triple the water volume in the bay, with the inflow composed of a combination of high salinity water from the gulf and lesser saline water from the east bay.

## SALINITY EFFECTS

As we know, the current salinity regime in the Galveston Bay system is the combined result of tidal fluctuation and fresh water inflow from the rivers feeding into the bay. Generally, the eastern sections of the bay have had a significantly lower average salinity than the western portions. For the purposes of the study, a simple program was developed to demonstrate a salinity rise in the rollover bay as a result of local dredging. The parameters used in the run were:

1. Maximum tidal flow over a 25 hour period between 0.7 and 4.2 ft/sec. Flood and ebb tidal values are not discerned, however; the 1972 report by Prather and Sorenson indicated that the pass is a flood-dominant tidal inlet.
2. An average baseline salinity in the bay is assumed to be between 16.9 and 17.2 ppt. with fluctuations of less than 1 ppt. through the year 2045.
3. Gulf of Mexico baseline salinity of 28-29 ppt.
4. Post dredge bay depth of 3 feet on average.
5. Maximum tidal velocity of 6 ft/sec. during the peak of the flood tide.
6. A fixed volume for analysis, i.e. a roughly calculated basin volume.

Results of the program indicated that a rise in salinity of 0.5 to 1.10 ppt. could occur in the bay after dredging, depending of course on rainfall and fresh water inflow from local rivers. Additionally, increased salt wedge penetration into the bay as a result of opening the bay and pass would no doubt contribute to the salinity rise. Under the USACOE plan H50 for widening and deepening the Houston Ship Channel (1986), it was noted that the channel forms a salt barrier between the east and west bays, indicating that the rise in salinity would be local rather than widespread.

## BAY FLUSHING

Due to the shape of the bay and its short, direct connection with the gulf, it is assumed that the bay does flush regularly, albeit slowly. The greater depth in the bay combined with the flood dominant characteristics of the pass could conceivably reduce the bay flushing time by up to 10 percent. At present there is a time lag of approximately 4 hours between the occurrences of high tide at the Galveston entrance and the bay side of the pass. This is an indication that during the ebb tidal cycle, water is attempting to move down the bay to the Galveston Entrance rather than exit through the pass. This condition is likely a result of the choking of the bay with sediment.

## CONCLUSIONS

Perhaps the simplest conclusion to be drawn from the data is that the proposed plan would be a solution to the erosion problem in the region around Rollover pass. The initial beach nourishment would stabilize the beach profile for a length of time sufficient to construct a jetty system around the cut. In addition to providing nourishment for the badly depleted beaches, the dredging operation in the bay would provide an area for the propagation of wetlands around the fringes of the bay. The new jetty system would interrupt the littoral transport around the pass, trapping sediment in a deposit area on the east side and directly adjacent to the pass. The vacuum effect, drawing large amounts of sediment into the bay would be counteracted by the jetty system. Periodically, the trapped sand would be collected from the deposit area and redistributed along the western side of the pass on feeder beaches. The sand would be moved from the feeder beaches by the natural littoral transport system and down the coast, emulating an uninterrupted littoral flow.

The cost of the operation presents a drawback to the operation, however; it should be noted that the 1989 study did not turn up any low cost effective solutions to the problem. It would seem that the team located the most cost effective method to counteract the erosion problems along the upper Texas coast.

## REFERENCES

1. Wang, Y.H., et al. "Preliminary Designs of Improvements at Rollover Pass and Vicinity, Bolivar Peninsula, Texas." A technical report presented at Texas A&M University at Galveston, Galveston, Texas. December, 1989.
2. Morton, Robert A., Shoreline Changes Between Sabine Pass and Bolivar Roads - Geological Circular 75-6; Bureau of Economic Geology, University of Texas, Austin, Texas, 1975.
3. Bales, Jerald D. and Holley, Edward R. Sand Transport in Texas Tidal Inlet; Journal of Waterway, Port, Coastal, and Ocean Engineering, Vol. 115, No.4. ASCE July, 1989.
4. Prather, S.H. and Sorensen, R.M. A Field Investigation of Rollover Pass, Bolivar Peninsula, Texas. Texas A&M University, College Station, Texas. TAMU-SG-72-202.
5. U.S. Army Corps of Engineers. "Hurricane Wave Statistics for the Gulf of Mexico." Technical Memorandum No.98. USACOE, 1957.
6. U.S. Army Corps of Engineers. Shore Protection Manual, Volumes I and II. Department of the Army, USACOE, 1984.

## APPENDIX I Supporting Statistics and Figures

## DETACHED OFFSHORE BREAKWATERS FOR GALVESTON COUNTY

Alan D. Black and Mike Strech\*

**ABSTRACT:** The Gulf Coast regions of Galveston County, especially the west end of Galveston Island and the Bolivar Peninsula, are prone to physical loss of land. One viable solution to combat this erosion is the use of detached offshore breakwaters.

### INTRODUCTION

As directed by Galveston County and the City of Galveston, Dannenbaum Engineering Corporation (DEC) has investigated various coastal sites that may warrant some measure to protect them from continued erosion. The focus of this discussion will center on the areas which are not currently protected by structures. Though erosion is very evident at the face of the Galveston seawall, erosion is occurring in many areas along the Gulf Coast and Intracoastal Waterway. The Texas Department of Transportation's 1990 aerial survey of the shorelines have been compared to the results from previous U.S.G.S. maps and some areas were found to exhibit significant erosion at many areas where no shore protection structures exist. If these areas are not incorporated into the County's comprehensive shore protection program, storm force waves would continue to erode existing coastal features.

History shows that the storm force waves are the most significant to the shore line changes that occur in Galveston County, though the daily wave actions also can not be ignored. The recent surveys indicate that these ongoing shoreline changes will impact the existing economic and environmental balance. The Galveston seawall serves as a good example of the economic impacts that a shore protection system can create. Most large-

---

\* Professional Engineers, Dannenbaum Engineering Corporation, 3100 West Alabama, Houston, Texas 77098

scale, tourist-related projects rely on the protection of the seawall and are located accordingly. Without this magnitude of protection, the investors might have been less ambitious with their developments. Even with this seemingly effective protection structure, we can see that the existing west end of the seawall could be the victim of these on-going shoreline changes. When this seawall is compromised, the commercial establishments which are protected by it are also at risk. As the seawall, subdivisions and roadways encroach upon the beach, their disruption of the natural dune build-up processes speeds the beach loss process that threatens the structures. Aerial surveys have shown the relevance of this process at two, west-end Galveston Island subdivisions and also along F.M. 3005. Even the intracoastal water way and its eco-systems are at risk as the Gulf wave actions widen existing (or open new) breaches in the barrier island.

These future losses or changes are the subject of this study to identify sites which can no longer be overlooked. The key to a workable protection system centers on identifying sites that are at risk, prioritizing the mitigation steps, then implementing measures that will result in protecting Galveston County's beaches, land, resource and waterways. As the Flood Emergency Mapping Agency (FEMA) develops legislation to influence coastal developments, mitigation of these problems will serve as the only vehicle for protecting the real estate market and attraction to this island community. A workable protection program would significantly influence FEMA's 10, 30 and 60 year erosion rate estimates which will directly effect construction, insurability and attraction to this area.

## HISTORY

These apparent shoreline changes have resulted from various mechanisms influencing the land. Among these, storm wave energy is the most dramatic. Exhibit 1 illustrates the storm surge experienced during Hurricane Carla, 7-12 September 1961, where high water elevations were 8 to 15 feet above mean high water. The wave forces were created by hurricane winds which range between 75 and 125 miles per hour at the eye of the storm. This storm came close to setting a new record highest water level above mean high water for Galveston which was set in August 1915 at 10.1 feet. Where sites are protected by beaches and dune systems, the wave action erodes both as shown in Exhibit 2. The beach can change dramatically during a single storm event by this wave action process. In addition to the wave energy and its impact due to higher water levels, the direction also plays a significant role in the shoreline changing processes. Wave direction can be influenced by tidal changes, wind direction and physical, natural or man-made features. The Gulf Coast is the most susceptible to the highest wind generated waves created by the unobstructed fetch length typical of the open sea. The coast is continually influenced by wind and wave directions which are not normal (perpendicular) to the shoreline. Prevailing condition causes a longshore flow (along the beach) from east to west which carries sediments along with it. Depending on the position of a hurricane, this wind generated wave action can be much more significant during the storm than this normal prevailing condition. This affect, combined with higher surge tides, can erode beaches and dune systems to the point of threatening commercial, public and private developments. Soils are typically classified as fine sands and with very little marine habitat activity that would hold existing submerged

features (contours, sand bars, etc.) in place during an extreme storm event. For this reason, the unprotected shorelines are susceptible to the full storm wave energies limited only by the force of the storm.

The Galveston seawall was constructed in 1904 to address the concerns felt after the Hurricane of 1900 "which killed 6,000 people and destroyed 3,600 homes at the island city" [Ref. 5, p.1]. Though this structure has shown good performance in various storms since the seawall construction, the beach has continued to recede. The largest erosion of the seawall beach occurred during the storm of 1915 followed by various cycles of erosion and accretion which resulted in near total loss of the beach between 10th Street and 53rd Street by the year 1934. At this point, a cooperative beach erosion control survey proposed the construction of a groin system between 12th Street and 61st Street. Work continued through 1970 to improve and maintain the seawall and groin field protecting Galveston [Ref. 5, p.25].

Though these projects were essential to protect the city, little has been done to maintain other parts of the island which have also yielded under the force of the major storm events. The recent aerial survey highlights the history of the unprotected beach areas and can be helpful for predicting the future progression of the erosion and accretion process. From this aerial survey and additional field observations, DEC has identified the following sites where new shore protection structures are proposed to be incorporated into the County's shore protection program.

LOCATION	DESCRIPTION
1. Bolivar Peninsula	
Caplen/Crystal Beach	Existing stable dune system occasional beach at auto access points. plus/minus 100 ft beach replenishment, dune enhancement, and breakwaters
Fort Travis Ferry Landing	Proposed beach replenishment and breakwaters
2. Galveston Island	
61st Street to Pocket Park 1	South end of existing exposed end of seawall, lagoon, significant erosion potential, pocket park structure nearly in front of dune system, proposed beach replenishment, modification to seawall, breakwaters, or seagrass-like fabric

Spanish Grant to 13 Mile Road	Proposed beach replenishment, breakwaters, or fabric
Jamaica Beach to Indian Beach	Proposed beach replenishment, breakwaters, or fabric
Sunbird Beach to San Luis Pass	Proposed beach replenishment, breakwater, or fabric

### 3. Mainland

Bacliff/Kemah	Ship channel dredging, proposed breakwaters for wetland creation
---------------	--

## PROTECTION OPTIONS

For each of the locations where these new shore protection structures are proposed, the facilities will be constructed to complement beach and dune replenishment. The theme of the proposed protection follows a general plan to build-up beach and dune systems to serve as the primary barrier to the forces of a major storm event. The structure's role would complement the beach by reducing the affect of the daily erosion process (to hold the beach in place) and to aid in the energy absorption of the storm wave forces.

To maintain the shoreline given the usual wave climate at a site, the structure would need to limit the erosion effects resulting from longshore drift. This condition occurs at absolute location under consideration and results from non-perpendicular wave direction relative to the shore line. Driven by tidal changes and wind direction, the wave direction may vary form day-to-day or season-to-season. The design of a protection structure must ensure that the longshore drift energy is reduced at the shoreline to negate the associated erosive wave energies.

Storm events magnify this effect with stronger wave forces that approach according to wind direction and magnitude. Since the Galveston area is subject to hurricanes, we can expect the wave direction to vary as the rotational winds move with the storm.

When considering a solution for protecting a given shoreline, we know that there are very few options that can provide consistent and reliable performance for all of nature's variables. Most of the sites under consideration also involve aesthetics since they involve coastal beach fronts which support the tourist trade of the island city. Since these beaches are subject to tourist activities, bulkheads and revetments would not be acceptable. This leaves groins, jetties and breakwaters. Groins and jetties are long structures that project seaward from the shoreline to attempt to trap littoral drift at the shoreline and create an accretion area within its shadow. The existing groin field between 10th Street and 61st Street has shown relatively good performance in front of the seawall, but these structures

are not as favorable in swimming areas or where wave direction is close to perpendicular to the shore. More perpendicular wave directions that may occur during a storm could reach the beach without any energy loss due to a groin field. Jetties are more commonly singular structures that protect a specific site usually at channel or tidal inlet where littoral materials are detrimental. For this reason, jetties are not considered appropriate for maintaining or protecting a recreational beach front.

Shore-connected breakwaters, as proposed at the seawall, combine the groin field concept with additional energy dissipation at the seaward end by addition of breakwaters (tees). The concept effectively relocates the littoral zone to the area beyond the ends of the structures leaving a very controlled wave climate in the area between the shoreline and the relocated littoral zone. Since the construction cost would be relatively high for establishing a system of shore-connected breakwaters, DEC feels that these structures would not be suitable at sites where groins are not already in place.

## OFFSHORE BREAKWATERS

Offshore breakwaters appear to be the best solution for the task. They are designed to protect a shoreline on the leeward side of this linear structure which is usually oriented parallel to the shore. Offshore breakwaters have been constructed to protect harbors or erodible shorelines, serve as littoral barrier-sediment traps, or a combined function. Examples of some applications in the United States are included in Exhibit 3. This list is not complete and overlooks Louisiana's 43 breakwater installations protecting Highway 82 on that state's Gulf coastline. Unlike jetties and groin fields, these structures affect longshore transport a secondary condition resulting from their primary objective of reflecting or refracting incident wave energies. The structures require less materials (cost) than the shore-connected breakwater, but the engineer can design for similar results by forming a tombolo behind the structure. If desired, natural accretion can result in growth of the shoreline to the point where offshore breakwater becomes connected [Ref. Exhibit 4]. Tombolos usually disappear during a storm and then build-up again during normal conditions. Though this tombolo affect maximizes the length of shoreline for recreational uses, this may not be a preferred condition along the coastal shoreline on Galveston Island. By allowing more wave energy past the offshore breakwater, tombolos can be prevented and longshore transport can continue between the shoreline and structure. In each case, offshore breakwater will perform the required daily and seasonal beach protection while also aiding energy dissipation of storm waves approaching the shore from any direction.

The key to developing a system of offshore breakwaters centers around understanding to site specific marine environment. If one understands the wave direction, significant wave height and range or periods, tidal variations and existing erosive processes, offshore breakwaters can create very predictable results. Exhibit 5 summarizes U.S. Army Corps of Engineer's recommended logic process for arriving to a design condition. As this logic diagram shows, this is unique for each location. The process attempts to simplify the historical and highly variable conditions at a given site down to one design condition. This condition should approximate the most significant daily and seasonal wave climate which is



expected to be erosive to the subject site. Extreme storm events are not included in this assessment since the primary purpose for these structures is to protect or accrete the beaches. Though these structures will aid in energy dissipation during a storm, the storm surge will overtop the breakwater and the beaches will erode as a function of the remaining energy. After the storm, one can expect the shoreline to return to a new equilibrium state where beach naturally accrete to the lee of the offshore breakwater.

The primary application of this the DEC study proposes offshore breakwaters along the Galveston Island coastal shoreline. Historical data is readily available and thorough from the storm of 1900 to present. For the purpose of this study, DEC will focus on the littoral drift from east to west that is considered to be the prevailing condition [Ref. 7, p. 12]. The shoreline within the seawall groin fields is self-evident to the influence of this process. There is evidence of littoral drift between each pair of groins where accretion occurs near the base of each groin. The deposits are weighted toward the west side of each pocket and most of the beach has eroded from the middle. This pronounced concave result could be reduced through offshore breakwaters which could limit the longshore transport to a manageable level and result in a much less pronounced concavity as illustrated in Exhibit 6. Though this concept looks very good from the standpoint of long term beach protection, our current understanding of the costs indicate that breakwaters in the groin field may not be as feasible as expected. With the present-day estimated costs of \$5,000 per lineal foot for rubble breakwaters and \$300 per lineal foot to replenish today's beach to constant 300-foot width, the initial cost for breakwaters would be substantially higher than for beaches. For example, 600 feet of breakwater structure with 1,500 foot space between existing groins, would be 6.7 times more expensive than beach replenishment. When compared to the needs at other unprotected sites previously noted, this additional cost at the seawall seems unjustifiable. Taking future beach replenishment costs into consideration (with 7% inflation), the cost of breakwater structures would pay for an beach replenishment in 15 years, plus 50 percent of a replenishment 30 years from now. For this reason, DEC is recommending beach restoration within the seawall groinfield. Natural littoral transport and extreme storm events will eventually erode the beach, but a less costly beach restoration program can maintain satisfactory protection for the seawall and Galveston properties.

The expected benefits for offshore breakwaters apply more appropriately where sites are not currently influenced by shore protection structures. As noted by earlier presentations, offshore breakwaters could benefit the west end of the seawall where the erosion process is much more active and threatening. Similarly, public and private developments could benefit from offshore breakwater applications. As we had noted from the aerial photograph, these sites are influenced by their impact on the inherent obstruction of landside; natural dune build-up processes. The dunes will continue to erode in front of these structures until the property is loosed or condemned. The low maintenance aspect of offshore breakwaters can provide long term reliable protection for these relatively remote beach and dune systems.

Offshore breakwaters can be created in several ways. Though rubble mounds are most common in the United States, similar effects have been accomplished by structures consisting of cellular sheet-pile, rock-filled concrete caisson, timber crib, precast concrete

units and floating concrete cellular designs [Ref. 1, p. 5-61]. The designs can reflect or deflect all of the incident wave energy with more common solid structures or permeable features can permit some wave energy through the structure. If a wide expanse of shoreline is to be protected, multiple breakwaters can be spaced to accomplish the desired cusped spit or tombolo effect.

Two of these possibilities, non-permeable rubble mounds and permeable or non-permeable, precast concrete units, are under consideration for Galveston County. Each of these have advantages. Rubble mound breakwaters are permanent structures made from quarry stone or concrete equivalents according to availability of materials. Once in place, this structure has low maintenance cost as seen in the seawall groin field and may other applications here in the United States. The U.S. Army corps of Engineers has studied this type of structures and has published very detailed design guidelines. Initial installation would be started by floating construction methods, then as the structure grows to a suitable size, construction could continue from the top. As recommended by the Corps, a plan would be implemented where the breakwaters are constructed in phases. Careful attention would be paid to the effects at the shoreline, and additional length or additional structures could be added in response to the observations. Transportation and stock piling of material could be accommodated by barge where wave climates permit or as appropriate at a given site.

The precast concrete unit breakwaters follow the same principal but have not been as rigorously studied for long term applications. Two of these systems have been considered for this study:

**BEACH PRISMS (TM)** - Permeable triangular units available in heights ranging from two to six feet. The precast units are 6 to 8 inches thick and typically tied together into workable 10 foot long units (by post tension cables), then placed end-to-end. Earliest know installation showed good accretion in Queenstown, Maryland, 1986.

**BEACHSAVER(R)** - Manmade reef designed as elongated triangular units that are placed and interlocked together on wide precast or monolithic foundations. The first application was placed in 1984 on the Long Island south shore (New York). Additional installations have been placed in New York and New Jersey.

These precast units are expected to provide similar performance when compared to rubble structures, but the advantages center around the flexible applications for the structures. Like rubble, the precast units could be transported, stock piled and constructed by a floating operation. The same phasing concepts would apply where initial installations could be surveyed for performance. There is an extra advantage of relative ease of movement if the structure is not in the correct location or if the structure is needed at another site. These structures are expected to be more cost effective than rubble structure, though local suppliers may be limited. Both of these manufacturers provide products that are designed for the marine environment and may be the best alternative for demonstration project in the Galveston area.

## CONCLUSION

DEC is recommending that the Gulf Coast regions of Galveston County should be the subject of an on-going maintenance program that mitigates the erosion processes that are detrimental to the local economy. A phased approach should identify sites and implement shore protection structures according to erosion rate, relative cost of expected loss and availability of funds. Establishment of an order from most critical is necessary. We have identified three areas where offshore breakwaters should be considered. These include the west end of the Galveston seawall, the west end of Bolivar Peninsula between Fort Travis and the ferry landing and two subdivisions on the west end of Galveston Island. We can expect physical loss of land and property in the near future. If nothing is done, FEMA's work will stifle any additional development in these unstable areas. These offshore breakwaters will effectively stabilize these area and preserve the land's value and usefulness for the future.

## REFERENCES

1. "Shore Protection Manual", Department of the Army, Coastal Engineering Research Center, Volume I and Volume II, 1984 fourth edition, Second printing.
2. "The Marine Environment and Structural Design", John Gaythwaite, P.E., Van Nostrand Reinhold Company, N.Y. 1981
3. "Design and Construction of Ports and Marine Structures", Alonzo Def. Quinn, McGraw-Hill Book Company, N.Y. 2nd ed., 1972
4. "Hurricane Defenses Outline", Engineering News-Record, McGraw-Hill, November 4, 1991
5. "Galveston's Bulwark Against the Sea, History of the Galveston Seawall", U.S. Army Corps of Engineers, October 1981
6. "Working Breakwaters", C.S. Hardaway, Jr. and J.R. Gunn, Civil Engineering, October 1991, pp.64-66
7. "National Shoreline Study, Texas Coastal Shores Regional Inventory Report", U.S. Army Engineer, District Corps of Engineers, 1971

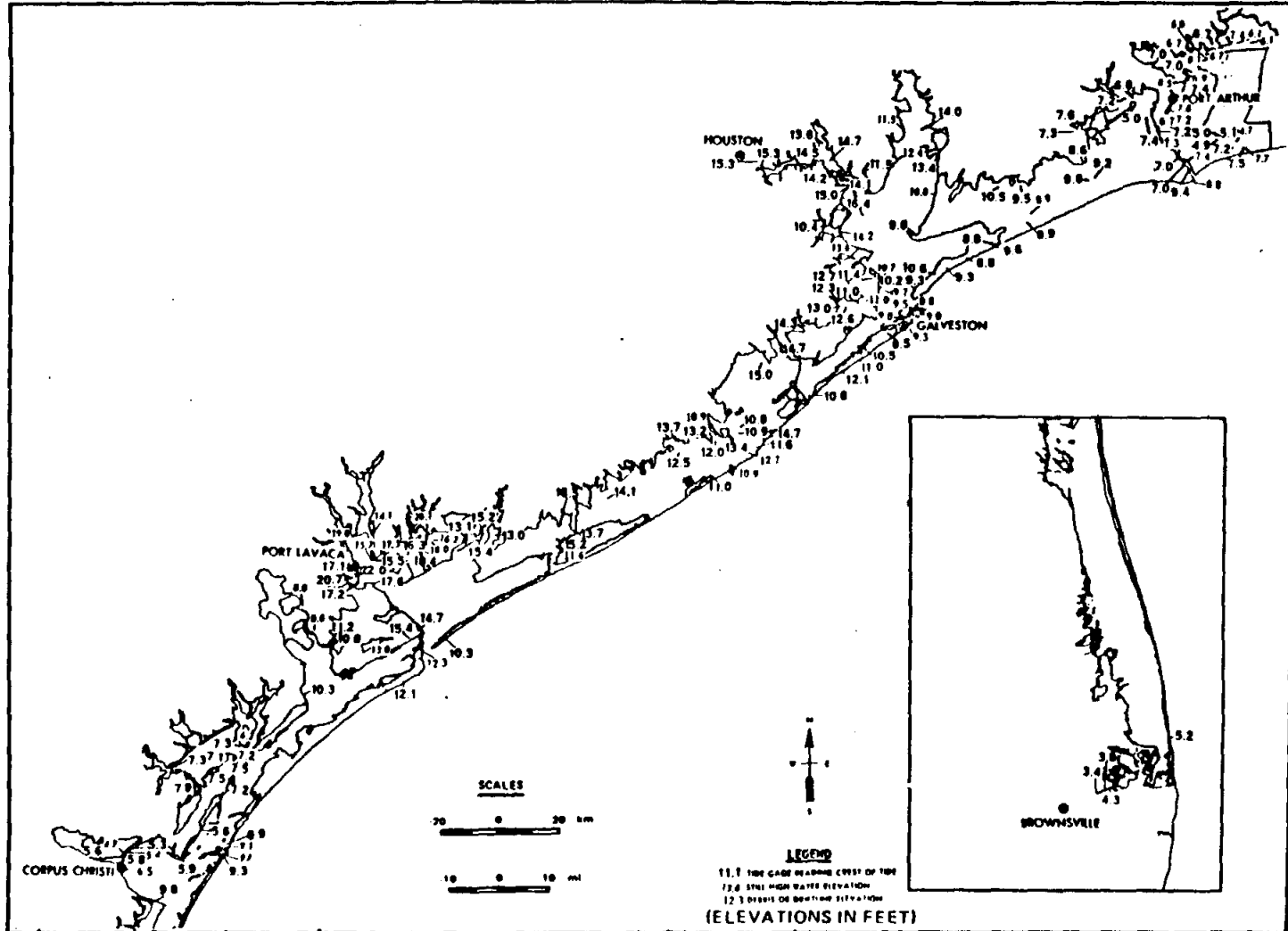

Exhibit 1. High water mark chart for Texas, Hurricane Carla, 7-12 September 1961.  
 (Shaded area indicates the extent of flooding.)

[taken from Ref. 1, Figure 3-55., p. 3-114]

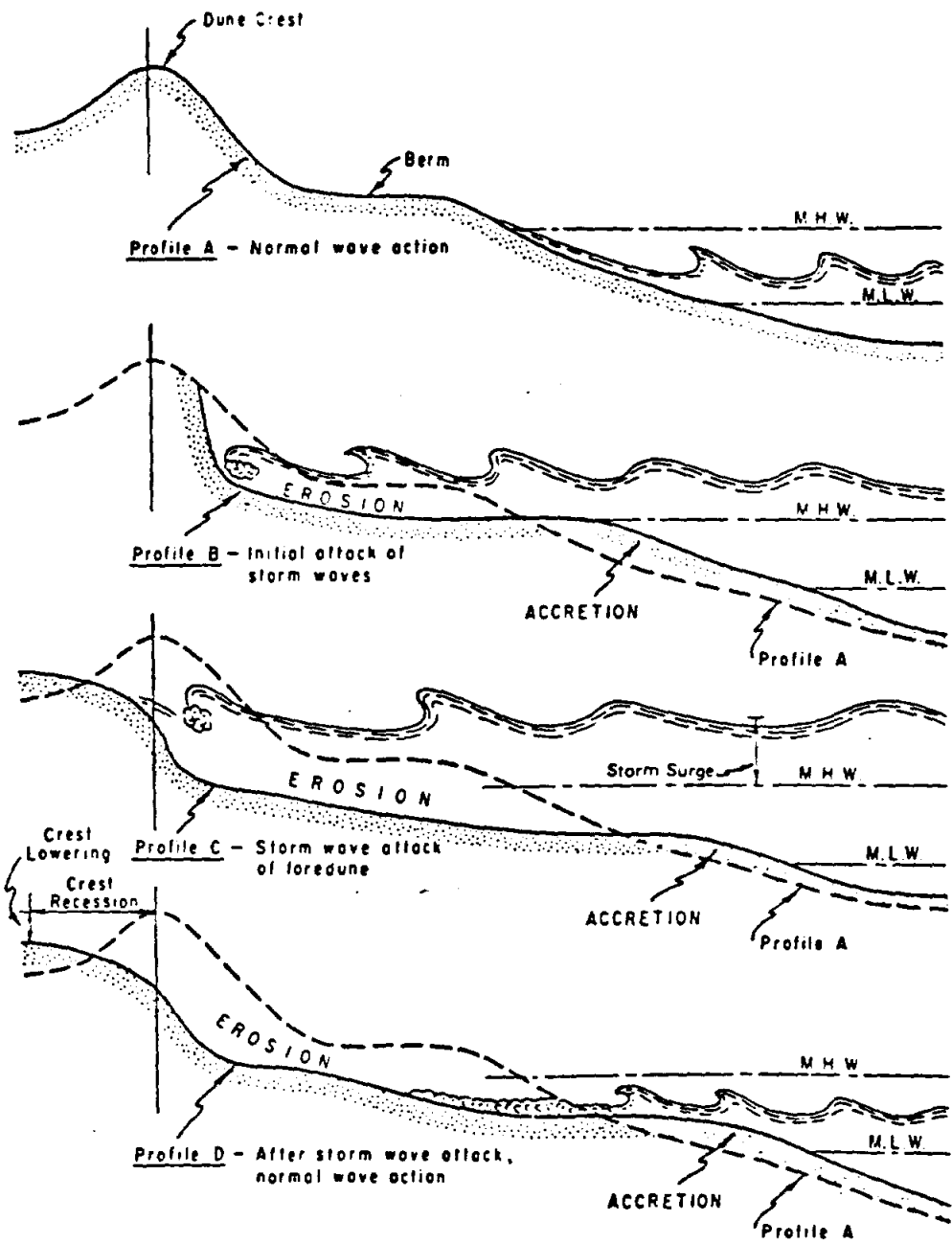

Exhibit 2. Schematic diagram of storm wave attack on beach and dune.  
 [taken from Ref. 1, Figure 1-8, p. 1-12]

Location	Construction date	Purpose	Type	Configuration	Shoreline response
Venice, Calif.	1905	Protect amusement pier	Rubble mound	Single structure; crest elevation: +3.7 meters (+12 feet) MLLW; depth: -1.8 meters (-6 feet) MLLW; length: 183 meters (600 feet); distance offshore: 213 meters (700 feet)	Tombolo connected to structure
Santa Barbara, Calif.	1929	Harbor or refuge	Rubble mound	Originally a single offshore structure; crest elevation: +3.7 meters MLLW; water depth: -7.6 meters (-25 feet) MLLW; length: 434 meters (1,425 feet); distance offshore: 305 meters (1,000 feet)	Tombolo connected quickly; structure extended to shore, 1930
Santa Monica, Calif.	1934	Harbor or refuge	Rubble mound	Single structure; crest elevation: +3.04 meters (+10 feet) MLLW; depth: -7.6 meters MLLW; length: 610 meters (2,000 feet); distance offshore: 610 meters	Periodic dredging has prevented connection of tombolo
Winthrop Beach, Mass.	1935	Shore and seawall protection	Rubble mound	Segmented structure; crest elevation: +5.5 meters MLW; depth: -3 meters (10 feet) MLW; 5 segments 91 meters (300 feet) long; gap size: 30 meters (100 feet); distance offshore: 305 meters	Unconnected feature formed at expense of neighboring shorelines
Waikiki Beach, Hawaii	1938	Shore protection	Rock-filled concrete cribs	Single structure; crest elevation: 0 meter MLW; length: 213 meters; distance offshore: 76 meters (250 feet)	Fill placed which eroded slowly over 8-year period
Lincoln Park, Ill.	1939	Shore and road protection; recreational beach	Steel sheet pile	Single structure connecting the seaward ends of four groins; crest elevation: -1.2 meter (-4 feet) MLW; water depth: -3.7 to -4.3 meters (-12 to -14 feet); length: 457 meters (1,500 feet); distance offshore: 183 meters	Fill placed and held satisfactorily
Channel Islands, Calif.	1960	Harbor entrance protection and sediment trap	Rubble mound	Single structure; crest elevation: +4.3 meters (+14 feet) MLLW; water depth: -9.1 meters (-30 feet) MLLW; length: 700 meters (2,300 feet); distance offshore: 550 meters (1,800 feet)	Large tombolo formed which is periodically bypassed
Haleiwa Beach, Hawaii	1965	Shore protection	Rubble mound	Single structure; crest elevation: +1.5 meters (+5 feet) MLLW; water depth: -2.4 meters (-8 feet) MLLW; length: 49 meters (160 feet); distance offshore: 91 meters	Unconnected tombolo formed
Lakeview Park, Ohio	1977	Shore protection; recreational beach	Rubble mound	Segmented structure with terminal groins; crest elevation: +2.4 meters (+8 feet) low water depth; water depth: -3.0 meters (-10 feet) low water depth; 3 segments 62 meters (205 feet) long; gap size: 49 meters; distance offshore: 76 meters	Series of unconnected tombolos formed
Presque Isle, Pa.	1978	Shore protection; recreational beach	Rubble mound	Segmented structure; crest elevation: +1.8 meters (+6 feet) low water depth; water depth -0.3 meter (-1 foot) low water depth; 3 segments 38 meters (125 feet) long; gap size: 53 and 91 meters (175 and 300 feet); distance offshore 46 meters (150 feet)	Series of smooth tombolos, connected at low water

Exhibit 3. Offshore breakwaters in the United States.

[taken from Ref. 1., Table 5-3, p. 5-62]



Exhibit 4. Breakwater applications in the Chesapeake Bay [Ref. 6. p.65]

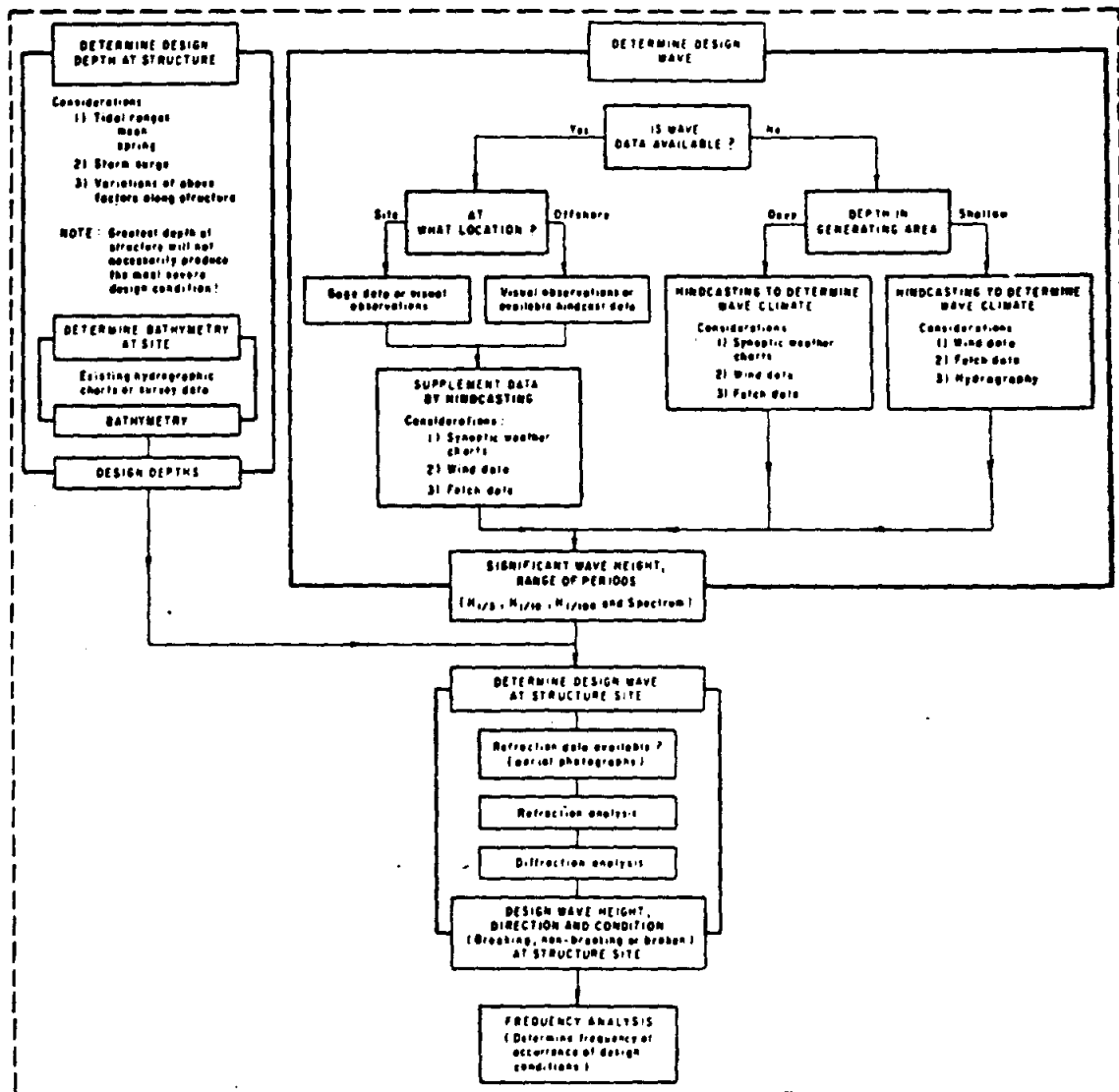

Exhibit 5. Logic diagram for evaluation of marine environment.  
 [taken from Ref. 1., Figure 7-6, p. 7-17]



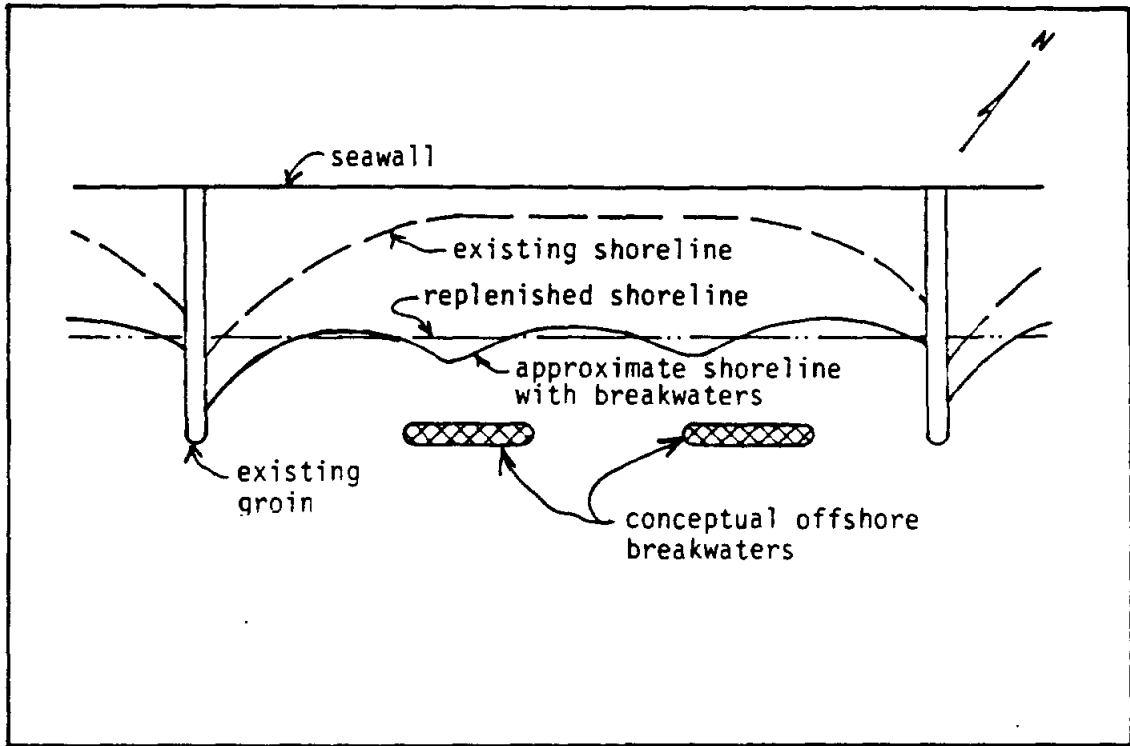

Exhibit 6. Breakwater applications at the Galveston seawall.

## **DESIGN OF BEACH NOURISHMENT FOR GALVESTON ISLAND**

### **(SEAWALL AND THE WEST END)**

**By Frank Frankovich**

#### **I. SHORELINE MOVEMENT**

The Galveston office of the Corps of Engineers, along with the Bureau of Economic Geology, has performed numerous studies along the Texas coast. Each of these studies has indicated that the "prevailing winds along the Texas coast are from the south and southeast. From Louisiana, the coastline extends generally southwest to the coastal bend area of Corpus Christi." Waves generated by the south to southeast winds produce a net littoral transport from northeast to southwest along the upper coast." Frequently during the winter months, and occasionally during other seasons, changes in wind direction reverse the directions of littoral transport for short periods of time. In general, littoral movement of beach and shore material along the gulf shore is interrupted both by artificial structures and by tidal currents through passes between the gulf and inlandbys."(1) See Exhibit "A".(2) The jetties at the entrance to the Galveston Ship Channel (constructed in the late 1880's) have effectively protected the channel from silting. They have also effectively blocked the flow of sediment to Galveston Island, disrupting the littoral process. Though the jetties protect the channel entrance, the channel requires periodic dredging to remove sediments which are carried in from the gulf and out from the bay. In the past, this dredge material has been disposed of in the open gulf or used to fill government land on the east end of Galveston Island and Pelican Island. Land on both Galveston Island and Pelican Island have been substantially elevated due to the placement of dredge material. Tidal currents in and out of the bay have caused an accretion of sediment on the north side of the jetties known as Big Reef. The specific reason for the buildup in the Big Reef area has not been identified, but substantial material is being trapped at this location.

## II. PROBLEM AREAS (PRIORITIZED)

Galveston Island can be divided into three basic zones: East Beach, the Seawall, and West Beach. EAST BEACH has continued to accrete since the jetties were constructed in the 1880's. Accretion down drift of jetties is not typical. The classical case of sand movement at an inlet with jetties is for accretion to occur on the up beach and erosion to occur on the down beach. The accretion of sand on East Beach can be attributed to the shoreward transport of dredge material off the south end of the south jetties, and sediment transported from the groin field during seasonal changes and changes in the direction of the wind. Sediments carried shoreward are trapped in an area of no longshore transport which extends from the end of the south jetties to the groin at 10th Street. The seawall was constructed in several sections (see Exhibit "B") (3) from 1902 to 1963. The beaches in front of the seawall have continued to experience erosion since its beginning in 1903 and completion of the wall in 1963. See Exhibit "B." (3) The most significant loss of sand occurred during the 1915 storm. The beaches never recovered naturally from this loss. Continued erosion after 1915 threatened the seawall foundation and provided justification for the installation of the groin field in the 1980's. Since that time, the groin field has held sufficient sand to protect the toe of the seawall under normal conditions. However, the original design intent has not been achieved. The citizens of Galveston in the 1930's wanted a beach 300 feet wide in front of the seawall. A report to Congress justifying the groins' installation identified a 300-foot wide beach as the design intent. A dredge report in the early 1940's indicated that "experience with the existing groin system appears to have been already sufficiently long to warrant the statement that equilibrium has been reached. Although there is available an ample supply of drift sand, the spacing of the groins equal to three times their length appears excessive under the conditions existing at Galveston to arrest a sufficient portion of this sand for the formation of the desired beach and full

protection of the toe of the seawall."(4) Beaches in front of the seawall from 61st Street to the end of the seawall have eroded.

Although there is no danger of saltwater exposure to the concrete piling support within this section, there is concern about long term exposure of the steel sheet pile bulkhead at the toe of the seawall. Damage occurred at the base of the seawall during storms in the past. Substantial damage occurred during Hurricane Carla in 1961 when beaches still existed in front of this section of wall. The lack of beach increases the possibility of continued scouring at the base of the seawall which could expose the steel sheet pile wall along the base of the seawall to the salt water. The original groins were steel bulkheading; however, this material failed after 30 years of continued exposure to salt water.

WEST BEACH has continued to recede at an average of "1.8 to 2.6 feet per year." (8) The movement of the beach and dunes landward has created conflict between the Attorney General's Office and local residents. As dunes move inland and encroach on existing subdivisions, the beaches begin to narrow. Though citizens have tried to maintain and stabilize the dune line in front of their homes, structures have been lost to receding beaches. As a result of this inland movement of beaches and dunes, Highway 3005 is vulnerable to storm damage from Pointe San Luis to Bay Harbour and from Sunbird to Indian Beach. Road damage may also occur at each of the 18 dune cuts which allow vehicular access to the beach. These cuts allow unobstructed storm surges to enter the back beach areas.

### III. SAND SOURCES

Prior studies and reports have identified adequate sand sources on both the west and east ends of the Island. See Exhibits C and D.(5) The Corps of Engineers, the Bureau

of Economic Geology, and Texas A&M University have all identified sand of significant quantities to re-establish Galveston's beaches. Additional testing will be required to verify quality quantities and specific locations of sand sources.

The Corps of Engineers has an active navigational channel dredging program. Every two to three years, the Corps dredges the Galveston channel. Approximately 1.5 to 4 million cubic yards of material is removed and disposed of in the open gulf. Thus, in a ten year period, 15 to 40 million cubic yards of dredged material is lost in the gulf. The Corps estimates that it would take 1,344,000 cubic yards of material to replenish the beaches within the groin field during initial construction. They are currently studying alternatives for using dredge material to replenish beaches with the hope of implementing a program in the 1993 dredge cycle.

#### **IV. BEACH DESIGN**

The beaches in Galveston have a consistent slope. See Exhibit E.(6) Factors which must be considered when designing the beach are: "1) littoral movement; 2) beach sand characteristics; 3) characteristics of sand sources; 4) beach berm evaluation and width; 5) wave adjustment in offshore slope; 6) beach fill transition; and 7) location of feeder beach."(7) The Texas coast has a relatively mild wave tidal curve with variation ranging on the average of two feet. The cycle of re-nourishment is reduced to 10 - 12 years depending primarily on storm cycles. The Corps of Engineers is currently testing sediment within the channel to determine the quality and quantity for beach nourishment. The Corps report of 1985 indicated a typical restored beach section in front of the seawall and on West Beach (see Exhibits E and F) and recommended that the material be transported by truck to the groin field. DEC recommends that a wider backbeach and foreshore be installed and that the material be transported by dredging. The increased backbeach and forebeach will provide additional shoreline flood

protection and recreational benefits.

The primary movement of sand is from northeast to southwest. Therefore, the placement of sand within the groin field will result in the movement of this material to the southwest or to West Galveston Island. The groin field will act as a feeder beach until other replenishment phases of the plan can be implemented. Ideally, a feeder beach should be created at the end of the seawall, allowing sediment to move each direction depending on winds and seasonal changes. A feeder beach at this location will protect the end of the seawall from flanking and will feed the West Beach area which relies on a natural system for storm protection.

#### V. PROJECT PHASING

Dannenbaum Engineering Corporation recommends that the beaches on Galveston Island be renourished in the following five phases: Phase I - in front of the seawall from 10th Street to 61st Street; Phase II - 61st Street to the west end of the Seawall; Phase III - Spanish Grant Subdivision to Galveston Island State Park; Phase IV - Galveston Island State Park to Indian Beach; and Phase V - Sunbird Beach to San Luis Pointe. In addition to beach replenishment, we recommend that dunes be installed on the beach in front of the Seawall and landscaping be planted to soften the hard structures in these three highly visible locations. (See Exhibits F and H.) Dunes should also be rebuilt on the west end of the Island where the dunes have been breached for vehicular access and by prior storms. If vehicular access is necessary to provide public parking, cross over ramps should be installed over the dunes to provide storm surge protection.

## **VI. CONCLUSION**

Unless some replenishment action is taken to better manage the sediment resources within Galveston County, we will continue to see our beaches erode. Better utilization of our sand resources can provide continued storm surge protection for existing structures. A management system will protect existing structures and thereby maintain and strengthen the County's tax base. We hope the city, county, state and federal governments will work actively in the future to protect Galveston County's number one natural resource - its beaches.

## **BIBLIOGRAPHY**

- (1) *National Shoreline Study, Texas Coastal Shores Regional Inventory Report* by U.S. Army Corps of Engineers, Galveston District, 1971.
- (2) *Gulf Shoreline of Texas: Processes, Characteristics, and Factors in Use*, by J. H. McGowen, L. E. Garner and A. H. Wilkinson, Bureau of Economic Geology, The University of Texas at Austin, Austin, Texas, 1977.
- (3) *Rehabilitation of Galveston Groins*. Design Memorandum No. 7, U.S. Army Corps of Engineers, Galveston District, May 1967.
- (4) *Report on Galveston Bay, Texas, for the Reduction of Maintenance Dredging*. U.S. Army Corps of Engineers, Galveston District, Vol. 1 of 3, May 15, 1942.
- (5) *Galveston County Shore Erosion Study*. U.S. Army Corps of Engineers, Galveston District, 1985.
- (6) *Shoreline Changes on Galveston Island*. Bureau of Economic Geology, University of Texas Austin, Texas, 1977.
- (7) *Shore Protection Manual*. Department of the Army Coastal Engineering Center, Volume I and Volume II, 1984, Fourth Edition, Second Printing.
- (8) *Shoreline and Vegetation - Line Movement, Texas Gulf Coast, 1974 to 1982*, Bureau of Economic Geology, Jeffrey G. Paine and Robert A. Morton, University of Texas at Austin, Austin, Texas, 1989.

# SEDIMENT-DISPERSAL SYSTEM AND SEDIMENT BARRIERS

- River-Borne Sediment
- Longshore Drift
- Onshore Transport
- Reservoirs
- Jetties

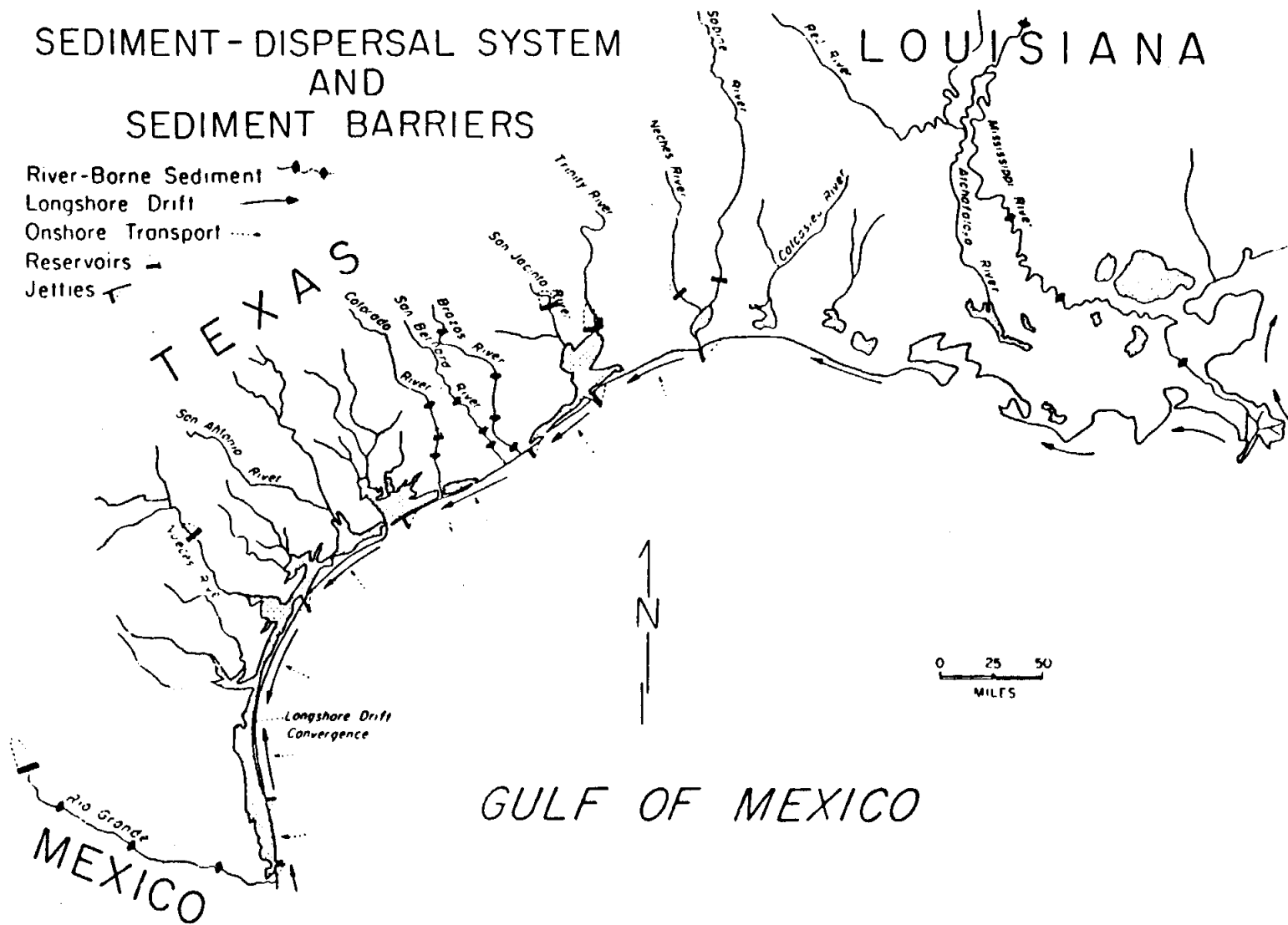

478

Exhibit "A" - "Sediment Dispersal System and Sediment Barriers"  
(Taken from Ref. 2, Fig. 17, Pg. 21)



47h

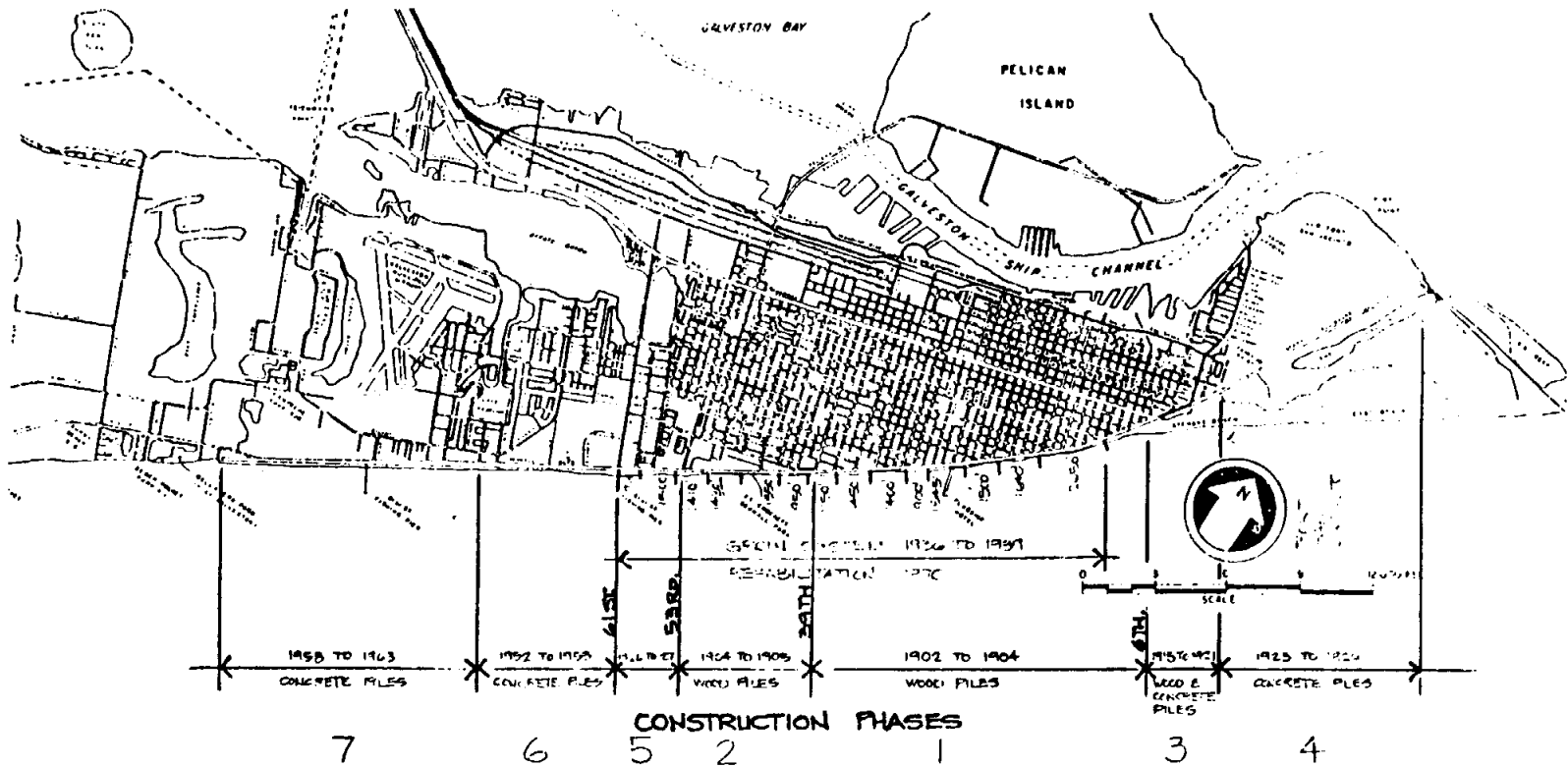
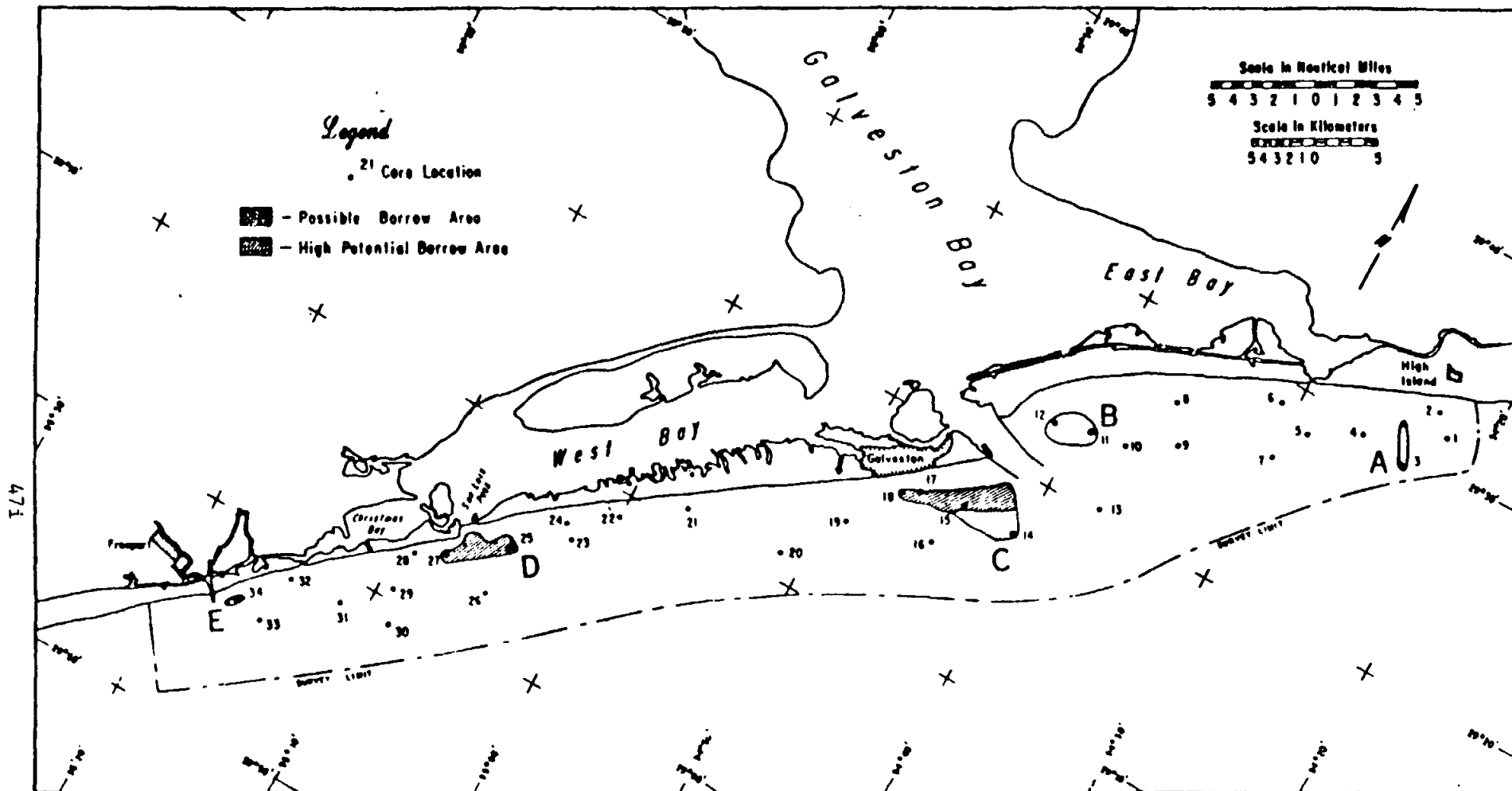

Exhibit "B" - "Seawall and Groin Construction Schedule"



## MAP OF FIVE POTENTIAL OFFSHORE BORROW AREAS

Exhibit "C" - "Map of Potential Offshore Borrow Sites"  
(Taken from Ref. 5, Fig. 44, Pg. 142)

CHARACTERISTICS OF POSSIBLE OFFSHORE BORROW SITES

Designation	Core Number	Water Depth (ft)	Thickness (ft)	Mean Grain Diameter (mm)	Standard Deviation (phi units)	Mud Overburden (ft)	Area (10 <sup>6</sup> ft <sup>2</sup> )	Estimated Volume (10 <sup>6</sup> yds <sup>3</sup> )	Remarks
Offshore High Island (Site A)	3	20-33	8-27	0.11 to 0.16	0.5 to 1.0	None	31.2	8.9	Sand is interbedded with mud as channel fill. Buried 20-inch gas line crosses site.
Offshore Polivar Peninsula (Site B)	11	18-28	6	0.16 to 0.23	0.42 to 1.04	4	106.6	12.9	Sand in core 11 occurs as basal channel fill and Pleistocene erosion surface. Sand in core 12 occurs in two layers separated by 3 feet of mud and sandy mud.
	12		3	0.16 to 0.23	0.50 to 1.39	3			
473 Offshore South Jetty (Site C)	14	18-32	7	0.12 to 0.19	0.51 to 1.06	None	297.1	26.9	Sand in core 14 is interbedded with muddy sand in dredge disposal area. Sand in core 15 occurs in two layers separated by 5 feet of mud and sandy mud. Sand and cores 17 and 18 is interbedded with muddy sand.
	15		2	0.12 to 0.19	0.53 to 1.02	1			
	17		18-30	0.13 to 0.17	0.40 to 0.81	2			
	18		13	0.10 to 0.16	0.43 to 0.78	None			
San Luis Pass Ebb Tidal Delta (Site D)	25	5-30	5-30	0.13 to 0.24	0.37 to 0.60	None	135.6	30.3	
	27			0.15 to 0.17	0.57 to 1.24	None			
Offshore Freeport (Site E)	34	18-23	8	0.10 to 0.12	0.61 to 0.88	1	8.6	2.7	Muddy sand in core 34 possibly part of the relief Brazos River Delta.

Exhibit "D" - "Characteristics of Possible Borrow Sites"  
(Taken from Ref. 5, Table 10, Pg. 143.)

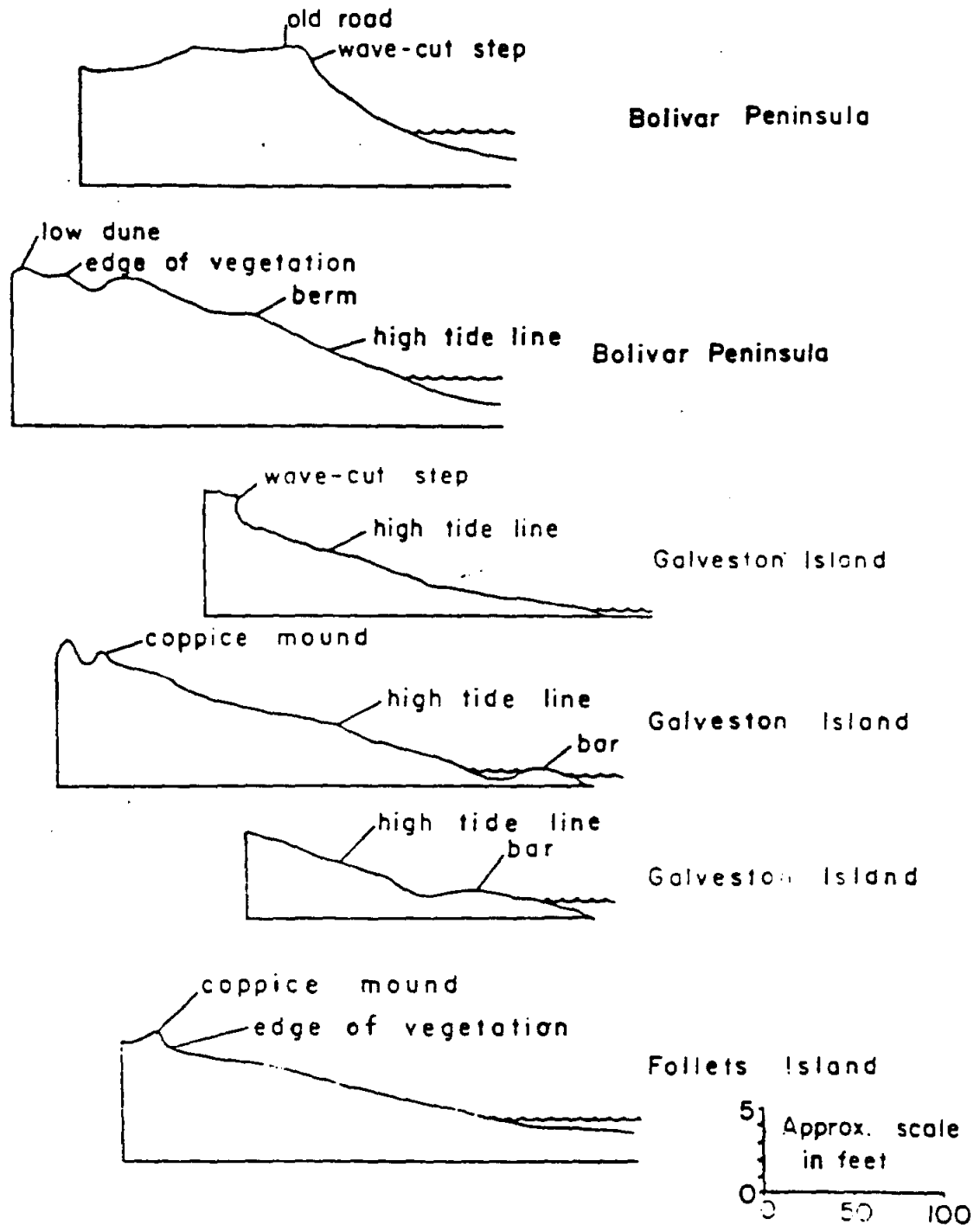

TYPICAL BEACH PROFILES FROM :  
MORTON ( 1974, 75 ) & MORTON and PIEPER ( 1975 )

Exhibit "E" - "Typical Beach Profiles"  
(Taken from Ref. 6)

478

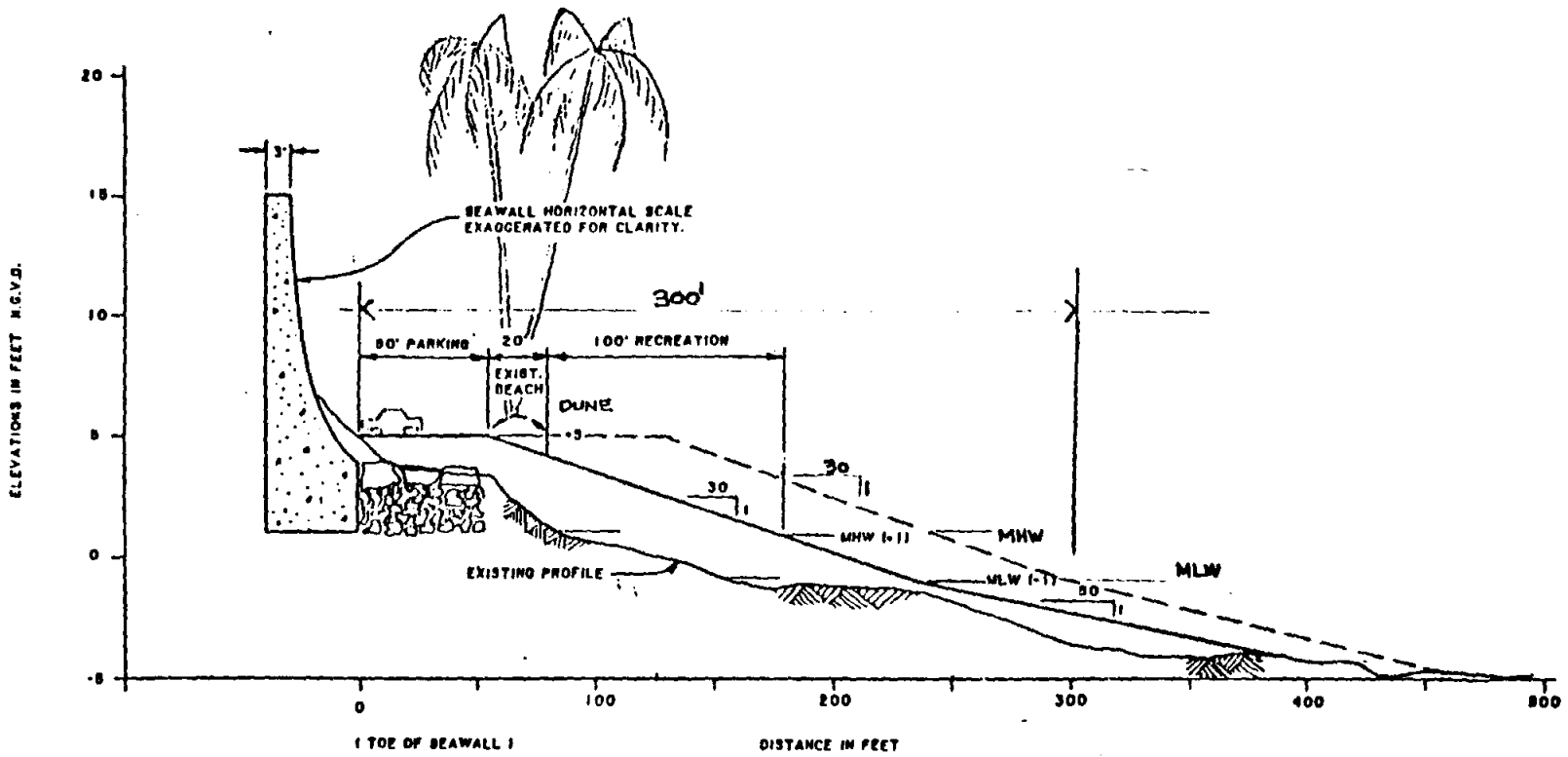

TYPICAL GROIN FIELD PROFILE

GALVESTON COUNTY SHORE EROSION STUDY  
GROIN FIELD PROFILE

Exhibit "F" - "Typical Groin Field Profile"  
[Taken from Ref. 5, Fig., 53, Pg. 200]  
Modified by Dannenbaum Engineering Corporation

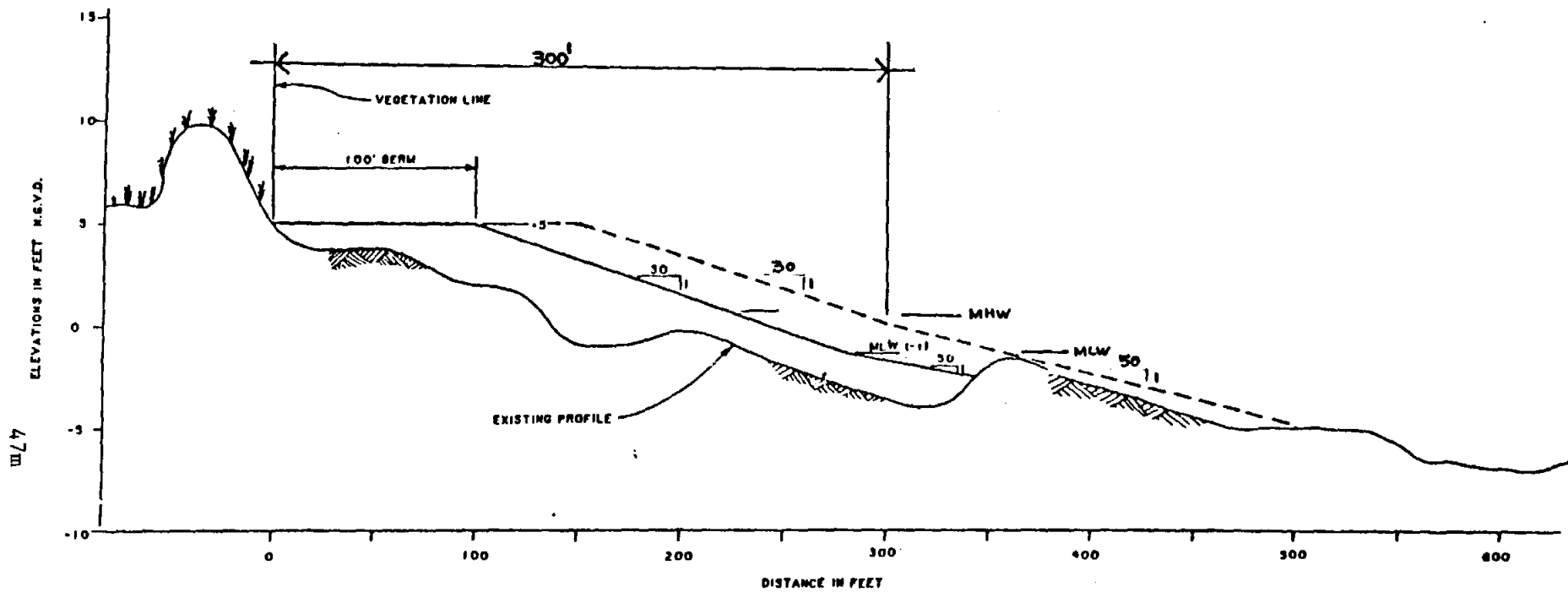

TYPICAL WEST BEACH PROFILE

GALVESTON COUNTY SHORE EROSION STUDY  
**WEST BEACH PROFILE**

Exhibit "C" - "Typical West Beach Profile"  
 [Taken from Ref. 5, Fig., 56, Pg. 204]  
 Modified by Dannenbaum Engineering Corporation

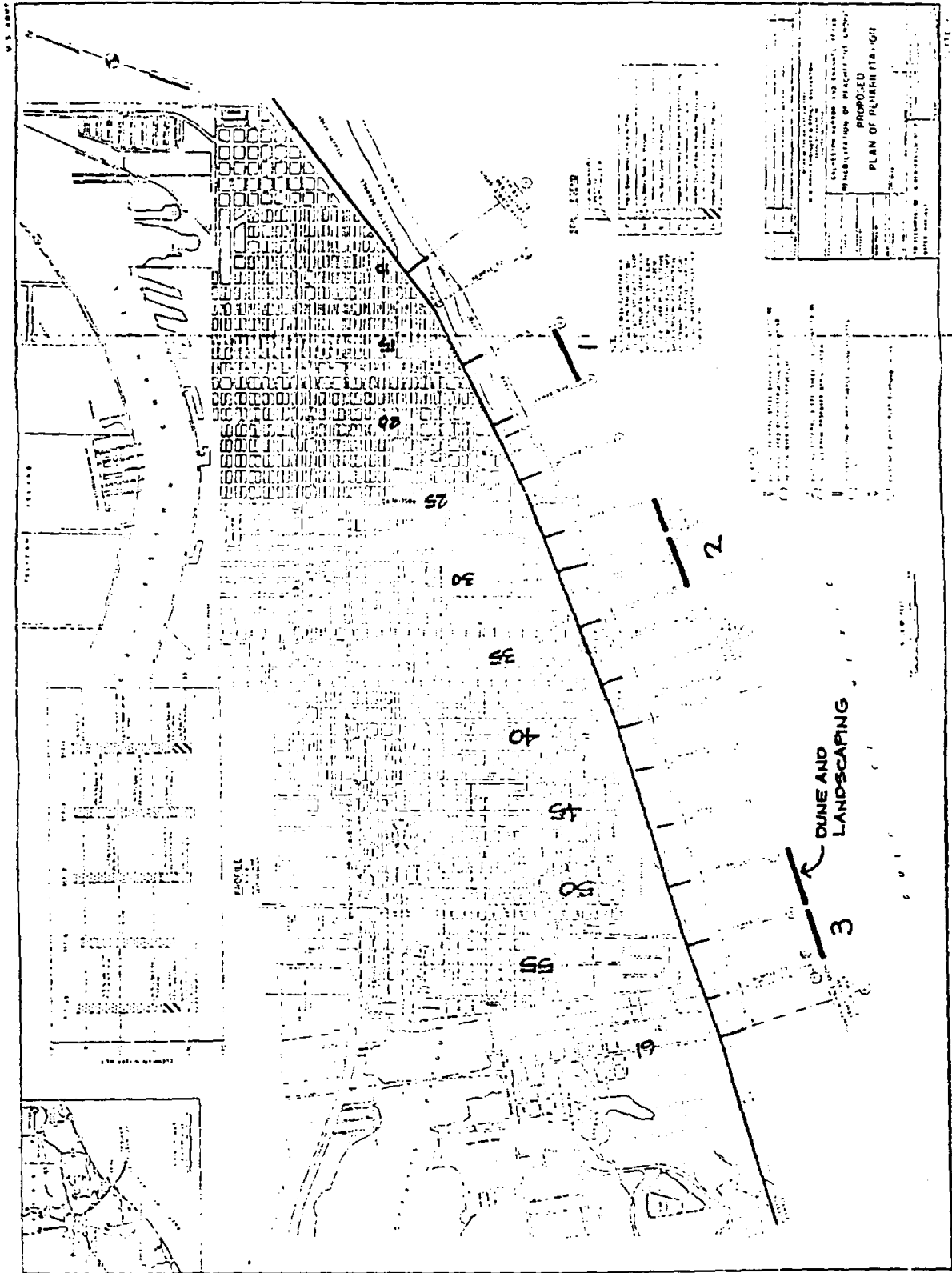

Exhibit "H" - "Dune, Landscaping, and Parking Locations"

## ALTERNATIVE SAND SOURCES FOR BEACH NOURISHMENT

by, Mark E. Leadon<sup>1</sup> and Y. H. Wang<sup>2</sup>

**ABSTRACT:** Beach nourishment has evolved over recent years as the preferred solution to beach erosion problems along developed coastal shorelines. Extensive beach nourishment projects have been conducted in the U.S. and have proven successful, such as at Miami Beach, Florida. Borrow source material for nourishment is generally obtained from offshore sites, tidal inlets and associated shoals, or from inland sand deposits. Selected borrow sites are based on consideration of availability, cost and quality of the borrow material. This paper will focus on these selection considerations with particular reference to Galveston Island. Retrieval of sand resources lost from beaches into inlet-related shoal systems generally provides a high quality sand for beach nourishment. Consideration should be given to the effect of sand excavation from inlet shoals on natural sand bypassing at the inlet to adjacent shorelines.

---

<sup>1</sup>Professional Engineer Administrator, Florida Division of Beaches and Shores, 3900 Commonwealth Boulevard, Tallahassee, Florida 32399

<sup>2</sup>Professor, Department of Maritime Systems Engineering, Texas A&M University at Galveston, P.O.Box 1675, Galveston, Texas 77553-1675



## INTRODUCTION

Beach nourishment has been conducted extensively along shorelines of the U.S. and other countries to restore eroded beaches in developed areas to provide storm protection as well as recreational benefits. Beach nourishment consists of the placement of beach compatible sand material from a source outside of the active beach system which is being restored. Such sand placement essentially results in a net gain of sand to the beach system and thus potential for adverse impact to the beach system and adjacent areas is low. The low impact potential exists provided the borrow material for the beach fill does not disrupt another component of the active sand sharing system and provided beach stabilizing structures which may accompany the fill do not disrupt sand transport to areas adjacent to the beach fill project. Successful beach nourishment projects have been constructed in several coastal states in the U.S. such as in Florida. A total of over 50 beach nourishment projects have been constructed in Florida including most of Dade County which contains the Miami Beach project where approximately 15 million cubic yards of sand was initially placed.

A total of about 60 million cubic yards of sand has been placed as nourishment projects in Florida. In addition, about 28 million cubic yards of sand have been placed on beaches as nourishment as a by-product of inlet navigational dredging.

Sand material placed on Florida's beaches has been obtained from various alternative sources. In a couple of cases, it has been economical and feasible to transport sand from inland sand deposits by truck or railcar for beach placement. However, the vast majority of sand has been obtained from offshore sources or, as mentioned, from inlets. In addition to sand obtained from navigational dredging operations, focus has increased in Florida on retrieving sand which has accumulated in inlet shoal systems and become essentially lost from beaches adjacent to the inlets. The quality of sand material contained in inlet shoals is generally found to be of a good quality for beach nourishment. This is understandable since the source of the majority of the shoal material is from adjacent beaches.

The beaches of Galveston, Texas have experienced long-term erosion. Following the devastating hurricane of 1900, the massive Galveston seawall was constructed along the Gulf of Mexico shorefront to protect the city of Galveston from any recurring hurricane assaults. The Galveston beaches experienced some recovery and widening after completion of the seawall. However, in recent years erosion and shoreline recession has occurred along the Galveston shore and throughout other portions of Galveston Island. Erosion control along Galveston Island has become of major importance and beach nourishment through retrieval of lost sand resources is, at least in part, the apparent preferred erosion control solution.

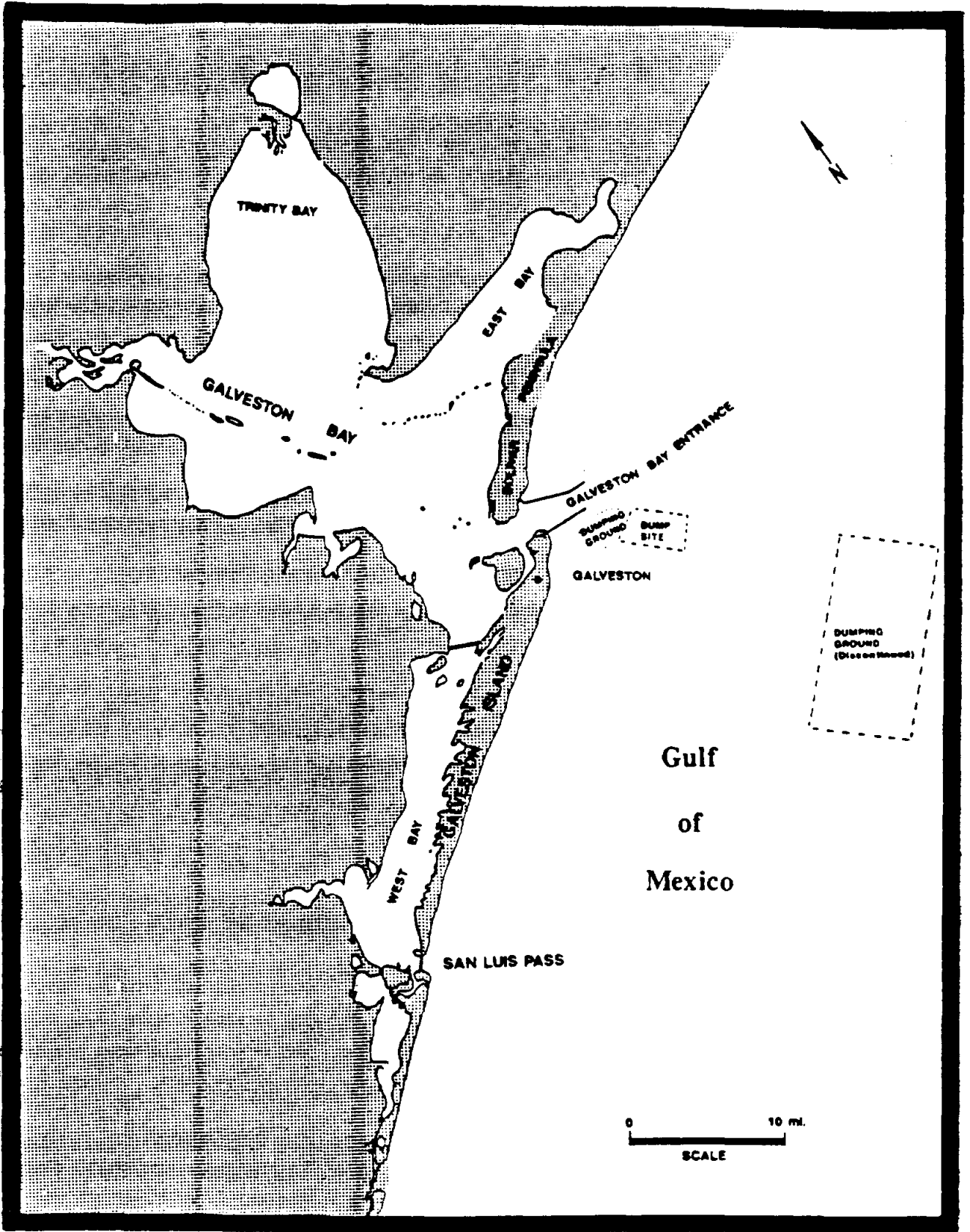

Figure 1. Galveston Island Map Including Nearshore Dump Sites

## BEACH EROSION ON GALVESTON ISLAND

Galveston Island is a coastal barrier island of approximately 29 miles in length along the Texas coast and oriented in a northeast-southwest direction. The island is bounded by Galveston Bay and West Bay to the north and west, the Gulf of Mexico to the south and east, and by two tidal inlets at its ends, Galveston Bay Entrance at its northeast terminus and San Luis Pass at its southwest terminus (see Figure 1). The island is extensively developed particularly along its northeasterly end where the City of Galveston is located. The geomorphic behavior of Galveston Island is typical of other barrier islands where erosion losses occur in the middle portions of the island with deposition near ends of the island and into adjacent tidal inlet systems. Erosion problems have been exacerbated by the development along Galveston Island where structures are located in close proximity to eroding shorelines.

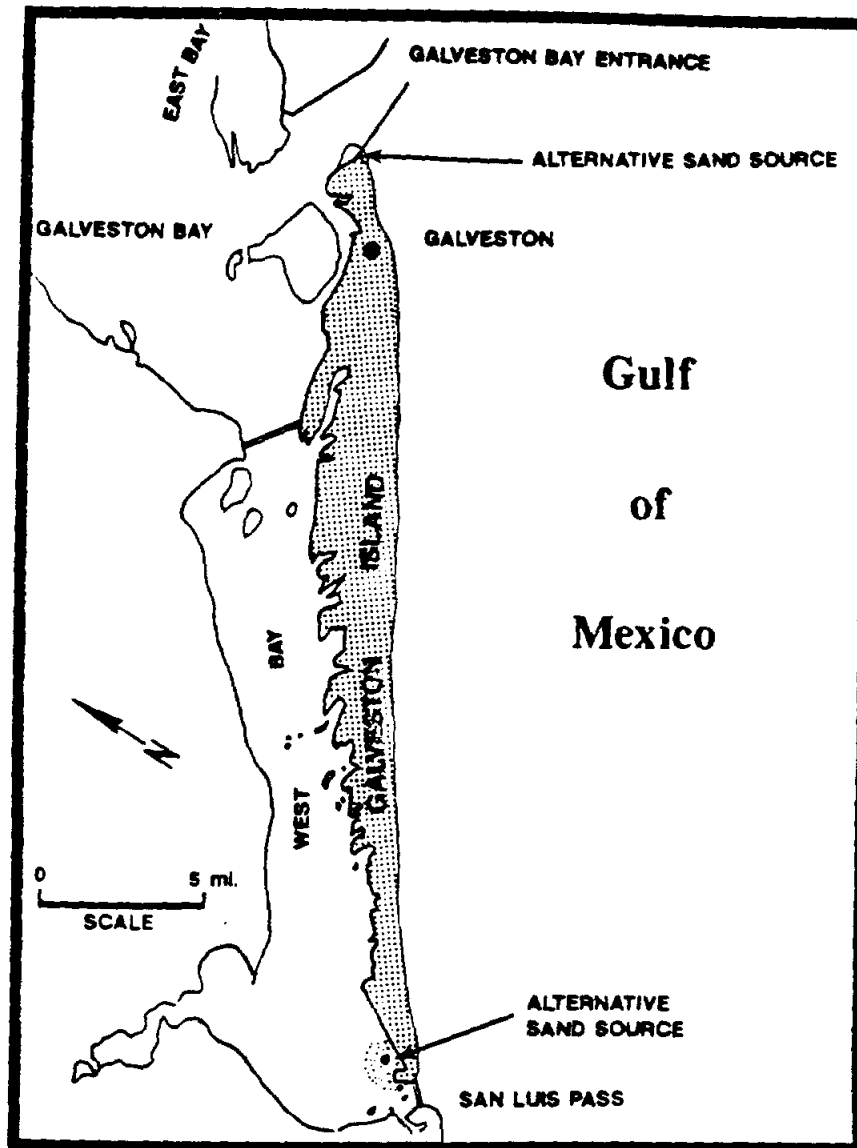

Figure 2. Location Map of Alternative Sand Fill Sources

## TIDAL INLET DEPOSITION

In the case of Galveston Island, sand deposition has occurred at the Galveston Bay entrance and at San Luis Pass. Sand deposition at Galveston Bay entrance has occurred adjacent to the northeast tip of the island where sand has transported over and through the rock jetty structure and into the inlet creating a large area of accretion immediately inside the jetty. Sand deposition at San Luis Pass has occurred predominantly into interior flood tidal shoals of West Bay and has created extensive sand deposits over a long time period (see Figure 2).

Galveston Bay entrance is a Federally-authorized navigation channel and has been dredged extensively by the U.S. Army Corps of Engineers. Dredged material from the entrance channel has been dumped into both nearshore and offshore sites. Sand material dumped into these disposal sites by dredging has effectively been lost from the active sand transport system. Although some of the dredged material in the nearshore site may be affected by sand transport mechanisms, the benefit of that material to upland beaches will likely be minimal because of the water depth at which it has been placed. In addition, enlargement of nearshore shoals as a result of the sand dumping may negatively affect adjacent downdrift beaches by altering wave refraction patterns in nearshore areas. Optimum use of the dredged sand would be to return it to neighboring beaches where it will provide the greatest benefit, such as on Galveston Island.

San Luis Pass has not been dredged routinely for navigation. The large deposits of sand contained in the Pass's flood tidal shoals represent sand which has been essentially lost from the active Gulf-fronting beaches of Galveston Island.

## FEDERAL DREDGED MATERIAL DISPOSAL REGULATIONS

The Federal dredging regulations require the Corps of Engineers to place dredged material in the least-cost approved disposal site (9). Fortunately, it has often been the case in coastal states, such as Florida, that disposal of dredged sand onto beaches has turned out to be the least-cost alternative. Such cases usually have been in inner channel regions where dredging has been conducted by hydraulic pipeline dredge with direct pumpout capability. Generally, hopper dredges are used in deeper waters which are subject to higher seas. Hopper dredges require additional equipment for pumpout capability which generally increases the cost. Thus, beach disposal from dredging by hopper dredge usually is not the least-cost alternative and necessitates the need for additional funds for beach placement (7,11). Such additional funds for beach placement must be obtained from non-federal sources, such as state and local government.

In Florida, state law provides for state payment of up to 75% of the non-Federal cost of placement of inlet sand onto adjacent beaches (1). The Federal government may provide up to 50% of the added costs for beach placement as a cost sharing effort with the state, provided a favorable report supporting the cost-sharing is obtained from the Corps of Engineers (8,11). It is noted that the Federal government may also consider

the adverse impacts that a navigation inlet may have on the beaches of adjacent barrier islands and include an increase in percentage of Federal cost for a shore protection project on an adjacent beach to mitigate the adverse impact (6).

## **BEACH NOURISHMENT FOR GALVESTON ISLAND**

Alternatives to the beach erosion problem on Galveston Island may include a combination of solutions. Such solutions may include increased restrictions on development on the island. However, in locations where the beach has been eroded away and existing upland development provide justification, shore protection projects appear to be necessary. Shore protection projects may involve placement of hardening structures such as seawalls and revetments, or shore stabilization by structures such as offshore breakwaters. Restoration of eroded beaches to provide for increased storm protection and recreational benefits suggest beach nourishment as a preferred alternative.

Beach nourishment in the case of Galveston Island may include a combination of obtaining sand for beach placement from the navigational dredging of the Galveston Bay entrance and the design and implementation of a beach nourishment project for a portion of the island. A major factor in consideration of beach nourishment is the source of material for nourishment. Potential alternative sources of sand for nourishment include offshore sources, some of which have been identified by the Corps of Engineers, and the sand deposits at both the Galveston Bay entrance and San Luis Pass. Consideration must be given in the selection process to the sand quality, cost and environmental impacts of each potential borrow source. Specific studies including these considerations should be conducted for each borrow source in the selection process. The quality of the sand in the inlet deposits is expected to be very similar to and compatible with the native beach sand. In fact, most of this identified inlet sand presumably was derived from the beaches of Galveston Island.

It is generally the case with inlet sand that it is of a coarser grain size and more similar to native beach sand than offshore sand deposits. This is certainly by no means absolute. Offshore sand exploration has resulted in the location of a number of coarse-grained sand deposits in Florida. Likewise some of Florida's coastal inlets have consistently produced finer-grained sand in navigation channels and associated flood tidal shoals. But the trend for inlets to produce the coarser grained sand is apparent. This apparent trend is demonstrated in review of a limited data set depicted in Figure 3 where mean grain size for both inlet and offshore borrow material is compared with that of nearby native beach sands.

The sand contained in the identified deposits at the Galveston Bay entrance and at San Luis Pass should be of a quality very similar to that found on beaches of Galveston Island. It is desirable to obtain a borrow sand material which is the same as, or coarser than, the native beach sand in grain size. The Corps of Engineers has developed methods by which to compare compatibility of alternative borrow sands with the native beach sand (3,9). The overfill of borrow sand vs. beach sand is calculated based on grain size and sorting differences between the native and borrow sands.

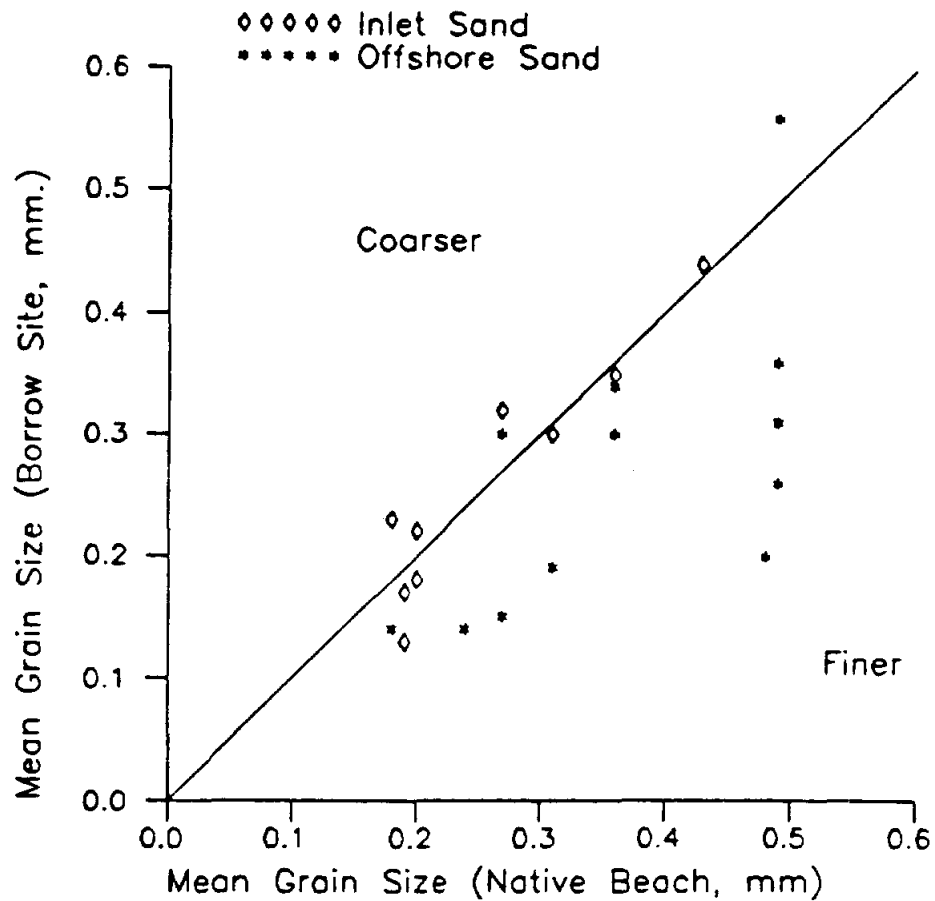

Figure 3. Inlet and Offshore Sand Grain Size Comparison

Dean (2) used the equilibrium beach profile concept as a means of comparing alternative borrow sands with native beach sands. The equilibrium beach profile assumes the form

$$h(y) = Ay^{2/3}$$

where  $h$  is elevation,  $y$  is distance and  $A$  is a scale parameter. The scale parameter decreases with decreasing sediment size. Dean illustrated that a coarser-sized nourishment material produces a greater dry beach width per unit volume of sand. A representation of an illustration from Dean in Figure 4 shows resultant beach widths for varying borrow material grain sizes. The spreading of nourishment fill in the alongshore direction is also affected by sediment size where alongshore losses of fill may be greater with finer size sand.

The cost of use of each alternative sand source must also be specifically studied. There are a number of factors which

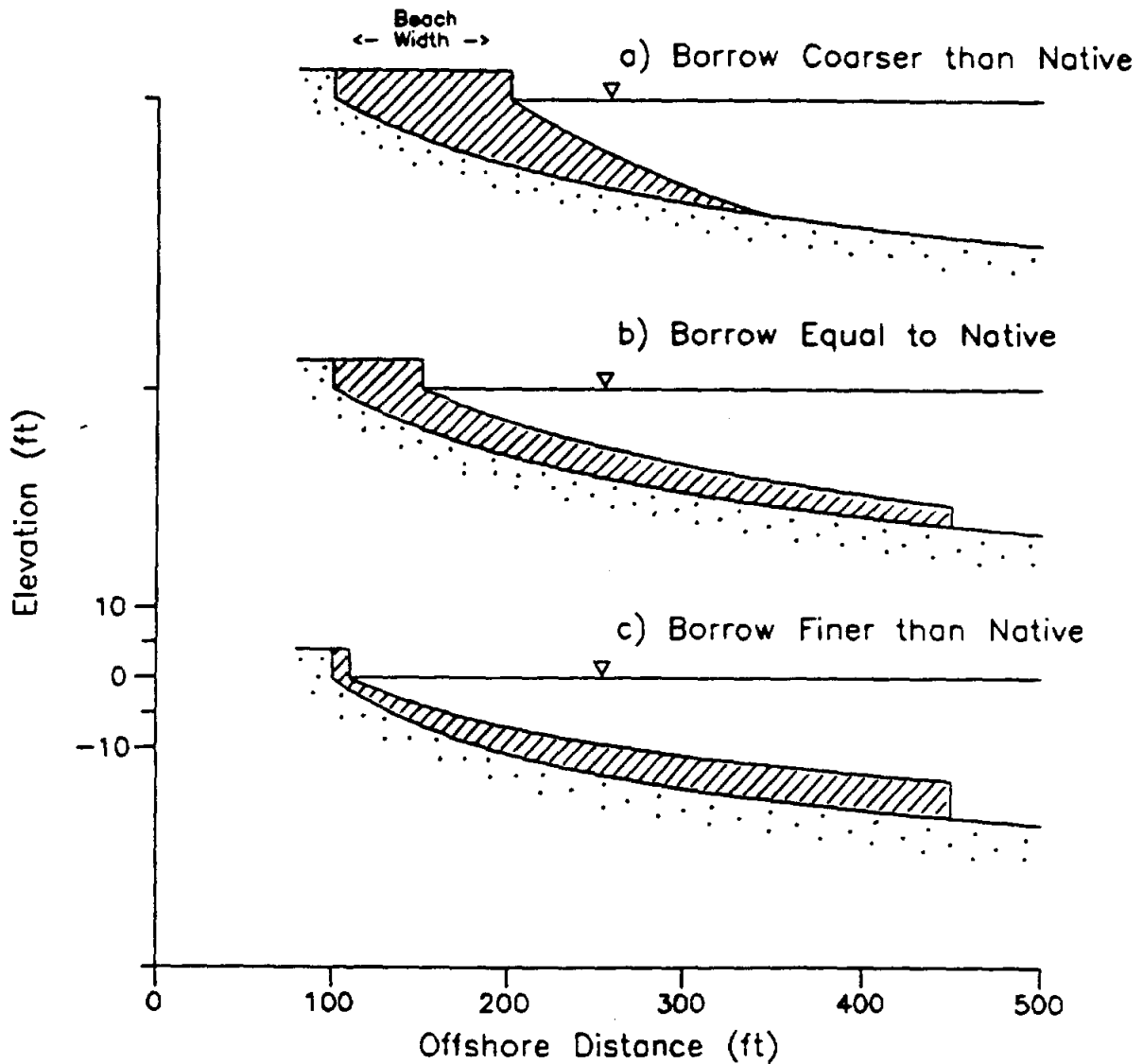

Figure 4. Beach Width Variation with Change in Fill Grain Size (representation after Dean (1988)).

influence the costs of one alternative versus another. Generally, the costs are greatly influenced by the distance from the borrow area to the beach nourishment project site and by requirements for additional dredging equipment, such as booster pumps, etc. A nourishment project may result in a combination of borrow sites, using offshore material from borrow sites which are in reasonably close proximity to the nourishment site and using inlet sand from adjacent tidal inlets. Optimum use of sand dredged from inlet navigational dredging which is in close proximity to a nourishment project site should be incorporated into the project planning and design. Leadon (4) reviewed costs for nourishment from sand obtained from inlet navigational dredging and compared them

with costs for nourishment from offshore sources and found the unit cost of nourishment for the inlet sand, in general, to be significantly lower than for the offshore sand. An illustration of such a cost comparison is given in Figure 5. The costs of placement of the inlet sand contained in Figure 5 reflect, in most cases, the added costs for placement of the inlet sand on adjacent beaches instead of in offshore sites. They also do not reflect any Federal 50/50 cost sharing discussed earlier, but only added costs which were provided 100% by non-Federal (State and local) sources.

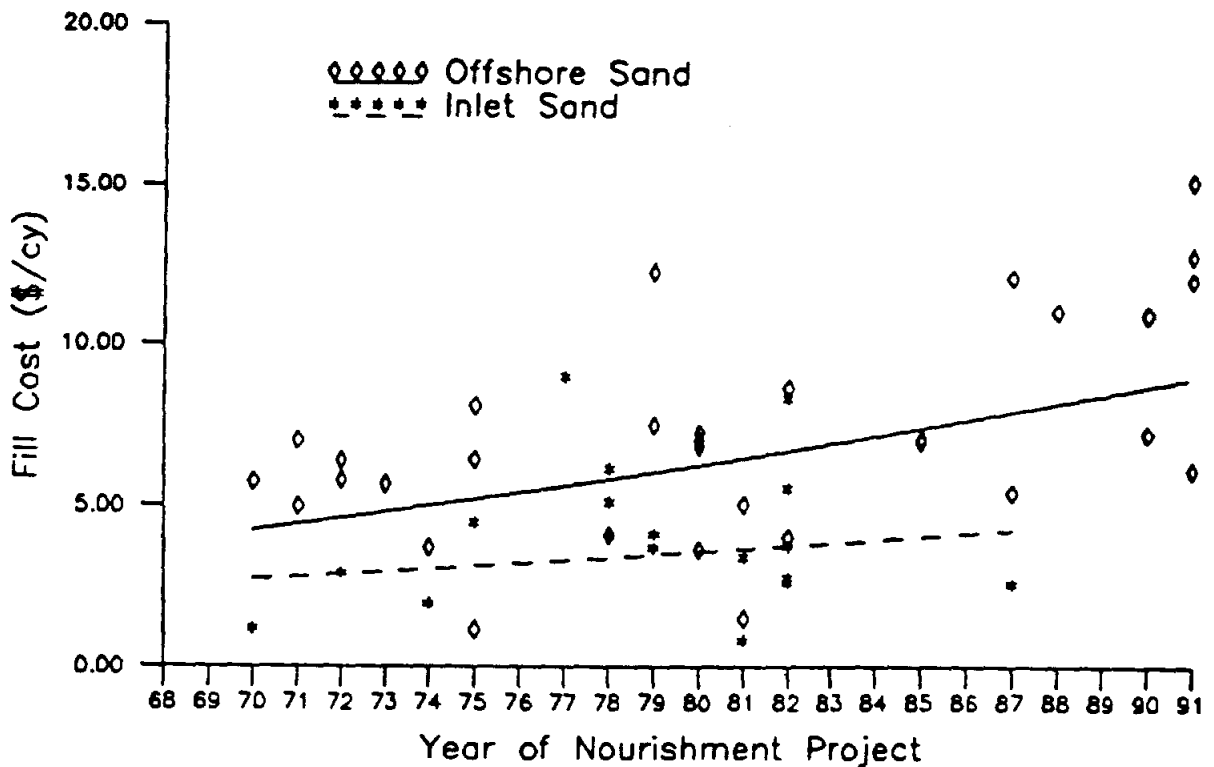

Figure 5. Cost Comparison of Nourishment from Inlet and Offshore Sources

In using inlet sand for beach nourishment, analyses must be conducted to ensure that there is no increased disruption to material sand transport and bypassing processes which may be occurring at the inlet. Such cases have been identified at some of the inlets along Florida's lower east coast, such as Jupiter Inlet, where studies have suggested maximum levels of allowable sand removal from ebb tidal shoals to minimize impact to natural bypassing around the inlets (5).



In both cases of inlet and offshore sand sources, environmental studies must be conducted. Environmental impact considerations may affect viability of use of an identified borrow source for a nourishment project.

## CONCLUSIONS AND RECOMMENDATIONS

Beach erosion along portions of Galveston Island have resulted in loss of recreational beach and loss of storm protection to upland development. Beach nourishment would serve to restore lost beach and recover the lost benefits. Review of alternative sand sources for beach nourishment should include analysis of sand deposits at tidal inlets adjacent to Galveston Island, as well as offshore borrow sites. Inlet sand is generally coarse-grained sand which provides good material for beach nourishment. Considerations in the selection of a sand source for nourishment should include availability, cost, quality of the sand and environmental impacts.

Efforts to obtain sand from inlet navigational dredging at Galveston Bay entrance for beach nourishment should be pursued. Cost-sharing with the Federal government for the added cost of placement of the navigational dredging sand on the beach may be available. Overall costs of beach nourishment where sand has been obtained from tidal inlets, including that from navigational dredging, have been lower than for nourishment from other alternative sources. Studies may show this to be the case for Galveston Island.

## REFERENCES

- 1) Chapter 161, Florida Statutes, "Beach Shore Preservation Act."
- 2) Dean, R.G., "Engineering Design Principles", Short Course on Principles and Applications of Beach Nourishment, Chapter 3, March 22, 1988.
- 3) Hobson, R.D., "Review of Design Elements for Beach-Fill Evaluation", U.S. Army Corps of Engineers, CERC TP 77-6, June 1977.
- 4) Leadon, M.E., "Use of Inlet Sand for Beach Nourishment in Florida", ASCE Coastal Zone '83 Conference, Volume III, June 1-4, 1983.
- 5) Mehta, A.J. and Montague, C.L., "Management of Sandy Inlets: Coastal and Environmental Engineering Imperatives," ASCE Coastal Zone '91, pgs. 628-642, July 1991.
- 6) PL 90-483, Sect. 111 (Title 33, Sect. 426i, U.S. Code) 1968.
- 7) PL 94-587, Sect. 145 (Title 33, Sect. 426j, U.S. Code) 1976.
- 8) PL 99-662, Sect. 933, Water Resources Development Act, Nov. 17, 1986.
- 9) U.S. Army Corps of Engineers, Shore Protection Manual, 1984.
- 10) U.S. Army Corps of Engineers, ER 1130-2-307, Oct. 31, 1968.
- 11) U.S. Army Corps of Engineers, EC 1165-2-142, Dec. 15, 1987.22

**SPACE SHUTTLE OBSERVATIONS OF  
SUSPENDED SEDIMENT, GALVESTON ISLAND**

**Mike Duncan\***

**ABSTRACT:** Still photographs obtained from the U.S. Space Shuttle, and environmental satellite data are used to note patterns of coastal and estuarine sedimentation in the vicinity of Galveston, Texas. Multi-spectral analysis is used to distinguish variations in the radiometric response of sediments along the Texas Gulf Coast and within Galveston Bay. Distributions of sediment are examined with regard to the physical and hydrodynamic characteristics of the bay and the nearshore area.

---

\* Engineer, Lockheed Engineering and Sciences, 2400 NASA Road 1, Houston, Texas 77058

## Nearshore Berm for Galveston Island, Tx

T. Neil McLellan\*

**ABSTRACT:** The high cost of beach protection has led many coastal zone planners to investigate effective lower cost alternatives for shoreline stabilization. One method currently being investigated by the U.S. Army Corps of Engineers is the use of dredged material to construct nearshore berms to protect the shoreline and augment the beach profile. Several projects have recently been completed and are currently under study. This paper investigates the potential of constructing an offshore berm near Galveston, Tx utilizing available borrow sources and equipment.

### BACKGROUND

Beach nourishment can be an effective method for augmenting, protecting and repairing a beach. The placed material also provides storm and flood protection to the back beach area. To date most beach nourishment projects involve placing suitable material from the dune area to the swash zone. The expense of this type of beach nourishment often limits the quantity of material which can be placed on the beach. In addition, as wave action redistributes the material throughout the active beach profile, severe local erosion can occur. Within the last ten years the construction of several shallow draft split hull hopper dredges have created the potential for economical and effective placement of sediment in the nearshore. Placement in the nearshore can be a little as half the cost of onshore placement and can provide several of the same benefits. Two types of berms can be constructed in the nearshore, a stable berm designed to attenuate wave energy, or a feeder berm placed to augment the beach profile. Which type of berm to construct can vary on several different factors, including wave characteristics, type of material, equipment availability, and overall berm intent. This paper will investigate the potential for a nearshore berm utilizing methodology developed by McLellan and Kraus (1991).

---

\* Civil Engineer, U.S. Army Engineer District, 444 Barracuda Dr., Galveston, Texas 77553

## NEARSHORE BERM CONCEPT

Nearshore berms are submerged, high-relief mounds constructed parallel to shore and are generally divided into two categories, called feeder berms and stable berms. Feeder berms are constructed of clean sand placed in relatively shallow water to enhance adjacent beaches and nearshore areas by mitigating erosive wave action and by providing additional material for the littoral system. Stable berms are intended to be permanent features constructed in deeper water outside the littoral environment. They may function to attract fish as well as reduce wave energy incident to the coast. Specifically, the term "berm" refers to a linear feature that resembles a longshore bar, whereas the term "mound" applies to any configuration of artificially placed material.

Benefits to the beach are conveniently classified as either direct or indirect according to the type of material, berm elevation and length, wave climate, and depth of berm placement. The direct benefit is widening of the beach by onshore movement of material from the berm. Indirect benefits are breaking of erosive waves, reduction of storm setup on the beach face, and creation of an artificial storm bar that will reduce erosion by satisfying part of the demand for sediment to be moved offshore during storms.

### FEEDER BERMS

If a berm is placed in sufficiently shallow water and with sufficiently high relief, the higher erosive waves accompanying storms will break on its seaward slope and crest. Broken waves of reduced height then reform and progress toward shore to break again with less energy. This energy-reducing mechanism provides an indirect benefit by reducing the erosional demand of storms for sediment to be moved to the offshore. Material removed from the berm and transported shoreward during periods of accretionary wave conditions supplements the beach profile by becoming part of the littoral system, contributing to the total volume of material available for beach recovery.

### STABLE BERMS

A stable berm is intended to be a relatively permanent bottom feature that attenuates higher waves, and it may function as a fish habitat. Material from the berm is not expected to be transported to the littoral system and beach. Berms designed to be stable may be constructed of a wider range of materials and grain sizes than feeder berms. However, not all material will mound adequately or have the required stability to function as a stable berm. Projects have intentionally spread material with low mounding potential over a large area utilizing what is called thin layer disposal (Nester and Warren 1987). If a stable berm or mound consists of beach-quality sand, it can be used as a stock pile for future beach nourishment projects.

## **BERM DESIGN**

The site manager must follow several steps to determine the potential for successful berm design and construction. These steps include evaluation of:

- a. Quantity and quality of material to be dredged.
- b. Availability of suitable equipment.
- c. Local wave conditions.
- d. Economics of berm construction and alternatives.

Material quality and quantity evaluations concern dredged sediment beach compatibility, mounding properties, and available volume. If the placed sediment grain size is compatible with beach samples, a feeder berm can be constructed. If the material is not compatible with the native beach material but does have mounding potential, a stable berm can be considered, whereas if the material is low-density fluid mud, mound construction is unfeasible. Past projects indicate that at least 150 cu m per linear meter is required to build a long feeder berm of significant height (above 1.5 m). Conical-shaped mounds placed in the nearshore focus wave energy behind them and should be avoided. Berm length should be several times the average local wavelength, and the berm should be oriented parallel to the trend of the shoreline to minimize wave focusing and depth limitations of the dredge, and maximize the extent of the shoreline to be protected.

Local wave conditions determine the depth of placement for supplementing the supply of littoral material by feeder berms, as described below. Material to be placed at the design depth and crest elevation will require suitable equipment, usually a split-hull hopper dredge. Early nearshore berm construction attempts were limited by the available dredging technology which required water depths of over 11 m for safe dredge maneuvering. Early berms remained fairly stable and had little or no measured impact on the beach (McLellan 1990). The relatively shallow draft, 6.7 m or less, and rapid split-hull placement technique allows the dredge to place material accurately and safely in the active littoral system. The dredges are equipped with modern electronic positioning, which can be used to ensure accurate placement for construction of a well defined submerged feature. In addition, a growing number of split-hulled hopper barges are becoming available for dredging and placement projects. Recent projects have shown that these dredges are capable of constructing mounds of elevation above the loaded draft of the vessel. Table 1 lists the maximum measured crest elevations and loaded drafts of hopper dredges from several projects.

Table 1. Sand Berms Built to Near Hopper-Draft Depths\*

<u>Location</u>	<u>Year</u>	<u>Contractor</u>	<u>Dredge</u>	<u>Volume</u> <u>1000</u> <u>cu m</u>	<u>Peak</u> <u>Elev.</u> <u>m</u>	<u>Loaded</u> <u>Draft</u> <u>m</u>	<u>Light</u> <u>Draft</u> <u>m</u>
Gilgo Beach, NY	1987	NATCO	Northerly Is.	321	-2.3	4.7	1.5
Lido Beach, NY	1987	NATCO	Northerly Is.	270	-2.4	4.7	1.5
Dam Neck, VA	1983	NATCO	Padre/Sugar Is.	650	-6.7	5.9	2.9
New River, NC	1979	Corps	Currituck	300	-0.9	2.2	0.7
Sand Island, AL	1987	GCTC	Atchafalaya Mermentau	350	-3.0	4.3 4.3	1.5 1.5
Brazos/ Santiago, TX	1989	NATCO	Manhattan Is.	180	-6.1	5.9	2.9
Silver Strand, CA	1988	Manson	Newport	75	-2.7	5.7	2.7

NATCO = North American Trailing Co.; GCTC = Gulf Coast Trailing Co.; Corps = Wilmington District, Corps of Engineers; Manson = Manson Construction and Engineering Co.

\*Hands, E. B, personal communication, 1989

Upon completing the evaluation procedure, berm design can begin. The design process entails determination of placement location, timing of placement, and berm length, width and crest elevation for a given volume of material. Ideally a nearshore berm would be constructed over a undisturbed stretch of beach. However, most are constructed near inlet channels, where the sediment is derived. Examination of the area must be conducted to ensure the berm is placed downdrift of the channel and away from channel effects. If seasonal reversals occur at the site, care should be taken to place the material during the season when it is most likely to move away from the channel.

The annual cycle of beach advance during the summer and recession during winter (in the Northern Hemisphere) is well known. Onshore sand transport tends to occur during periods of waves with low steepness during summer (wave steepness is defined as wave height  $H$  divided by wavelength  $L$ ), whereas sand is moved offshore during periods of high steepness waves, as occur during local winter storms, hurricanes, and extratropical storms. Material placed in the nearshore in early or mid-summer will more likely reach the beach than material placed just prior to storm season when it will tend to be distributed in the offshore.

Numerous criteria have been proposed to predict if a beach of a certain grain size will tend to erode or accrete under waves of a certain height and period. Here, discussion is limited to cross-shore transport, omitting consideration of longshore sand transport and

wave angle. Larson and Kraus (1989) developed a criterion that incorporated deepwater wave steepness and the sand fall speed parameter  $H_o/(wT)$ , in which the subscript  $o$  denotes the wave height in deep water,  $w$  is the sand fall speed in quiescent water, and  $T$  is the wave period. Kraus (1990) further verified the criterion with a data set of accretion and erosion events recorded on beaches around the world and found the following simple approximation was consistent with the original conclusions of Larson and Kraus:

$$\begin{aligned} \frac{v}{wT} < 3.2, & \quad \text{accretion} \\ \frac{H_o}{wT} > 3.2, & \quad \text{erosion} \end{aligned} \tag{1}$$

If the fall speed parameter is less than 3.2, then a beach will tend to accrete, whereas if it is greater than 3.2, a beach will tend to erode. In Eq. 1, the significant deepwater wave height and peak spectral period should be used. Fall speeds for common water temperatures and quartz grain diameters are given in Table 2, calculated by equations given Hallermeier (1981a).

Because Eq. 1 was developed from data describing large accretionary and erosional events, its application with all wave data should be viewed with caution at present. It is emphasized that the criterion applies to beach change resulting from cross-shore sand transport without consideration of longshore processes. Kraus (1990) describes limitations of Eq. 1. If the design calls for a feeder berm, it is optimally placed as close to shore as possible within constraints of safe navigation of the dredge. A berm will break waves that have a height approximately equal to the water depth at its crest. Placing the berm closer to shore, thereby decreasing the depth at the berm crest, will increase its potential to break waves, better protect the beach from erosive wave action, and promote movement of material forming the berm into the littoral zone. The greater the frequency of occurrence of wave breaking on a berm implies a greater potential for material to move off the berm and into the littoral environment. Conversely, if waves break infrequently on a berm and the berm is not exposed to strong currents, it will be stable.

Active beach profile change is an indication of the seaward extent of the littoral zone. This limiting depth is a function of the wave height, wave period, and sediment size and composition, and it is most reliably determined by reference to repetitive profile surveys and bathymetry maps for the site or a neighboring site that experiences the same wave climate. If adequate profile data do not exist, an analytic method introduced by Hallermeier (1981b, 1983) can be used to estimate the limiting depth. Hallermeier defined an annual seaward limiting depth  $d_{sa}$  of the littoral zone as,

$$\frac{d_{sa}}{H_{o12}} = 2.3 - 10.9 \frac{H_{o12}}{L_{o12}}$$

in which  $H_{0.12}$  is the significant deepwater wave height exceeded 12 hr per year, and  $L_{0.12} = gT^2/(2\pi)$  is the deepwater wavelength calculated with the wave period associated with  $H_{0.12}$ , where  $g$  is the acceleration due to gravity. In metric units,  $g/(2\pi) = 1.56 \text{ m/sec}^2$ , whereas in American customary units  $g/(2\pi) = 5.12 \text{ ft/sec}^2$ . In arriving at Eq. 2, the original expres-

Table 2. Short Table of Fall Speed Values (m/sec) (Quartz Grains)

Temperature Deg C	Grain Size, mm					
	0.15	0.20	0.25	0.30	0.35	0.40
10	.016	.023	.029	.035	.042	.048
15	.017	.024	.030	.037	.043	.050
20	.018	.025	.032	.039	.046	.053
25	.019	.026	.034	.041	.049	.055

sion of Hallermeier was modified by restricting consideration to quartz sand particles. Birke-meier (1985) tested Eq. 2 with high-quality data from the Coastal Engineering Research Center's Field Research Facility at Duck, North Carolina, and found that it held if the empirical coefficients were adjusted slightly for that site to give  $d_w/H_{0.12} = 1.75 - 9.2(H_{0.12}/L_{0.12})$ , thereby validating the basic functional dependence of the equation.

### Berm Dimensions

The overall dimensions and mounding characteristics of the berm depend on several factors including type and compaction of material, dredging and placement method, waves and currents during placement, and grain size. Once the proper depth and mounding potential have been determined, the crest elevation will be directly related to the loaded and unloaded draft of the dredge (see Table 1). Required loaded vessel drafts may be reduced by light loading the dredge. This most likely will not increase the final crest elevation, but will decrease the required depth for safe navigation.

The berm should be of sufficient length to avoid wave focusing by refraction. This phenomenon depends on the depth change at the berm, and wave height, period, and direction, and is presently under investigation. Existing berms are as short as 2.5 times the average wavelength and are not exhibiting wave focusing effects. The only reported problem occurred during construction of a berm at a Durban, South Africa, in which the ends tended to focus wave energy. The construction plan was changed to have 1 V (vertical) on 150 H (horizontal) end slopes in order to reduce these refraction effects (Zwamborn, Fromme, and



Fitzpatrick 1970).

The side slope achievable in berm construction is mainly a factor of grain size and sediment density, but the compaction of material, dredging and placement method, and currents during the placement also determine the final slope. At present little information is available on the angle of repose of dredge materials placed offshore. Several fine to medium sand berms have been constructed with side slopes ranging from 1 V on 100 H to 1 V to 30 H. A stable berm constructed off Mobile, Alabama, of fine sand, silt, and clay dredged using a clamshell dredge and placed with a split-hull scow attained slopes of 1 V on 24 H to 1 V on 130 H (McLellan and Imsand 1989).

#### Example Calculations for a Proposed Nearshore Berm: Galveston Island, Texas

Galveston Island area is an important resort area that is threatened by severe erosion (U.S Army Corps of Engineers, 1971). Several options, including beach nourishment, have been evaluated for reduction of this erosional trend. Williams, Prins and Meisburger (1979) identified several potential borrow sources for a beach fill project for Galveston Island and vicinity. As indicated by their study, the median grain size for Galveston Island ranged from  $d_{50}=0.130$  mm to 0.140 mm. A borrow source was identified off of Galveston's south jetty which had grain size ranging from  $d_{50}=0.10$  mm to 0.19 mm. Beach fill material is most effective when it is similar or slightly courser than the natural beach fill. For this exercise, only that portion of the borrow material which is similar or courser than the natural material will be evaluated.

At a minimum the berm should be at least 2.5 times the average wave length of the area. The average wave period at Station 11 is 5.6 s, which indicates a deep water wave length of 49 m. Approximately 150 m<sup>3</sup> of sediment/m is required to construct a berm of 1.5 m to 2 m in elevation. The minimum volume of material required would therefore be 18,375 m<sup>3</sup>. In general, this small amount of material would not be cost effective in a production operation. Production would more likely be on the order of 380,000 m<sup>3</sup> or greater creating a berm 2,500 m long.

Since the construction of a berm in Galveston Island would be relatively far from the Galveston Channels entrance, currents from the entrance should not be need to be evaluated. However, the large fillet formed by the jetty will need to be examined. The berm will need to be far enough downdrift so that shoreward moving material will not become trapped by the jetty's shadow. If the berm is constructed towards the east end of the island, care should be taken so that seasonal reversals will not move the sediment towards the fillet.

Long-term hindcast wave available from the Wave Information Study (WIS) will be used for the site. Table 3 gives statistical summaries of significant wave height  $H_s$  and peak spectral period from all possible direction for the 20-yr hindcasts (1956-1975). Table 3 is from WIS Report 18 (Hubertz and Brooks 1989) and includes both sea and swell from Station 11 directly offshore of Galveston Island. WIS tables contain wave information corresponding to 3-hr intervals; this results in 58,440 possible events for a 20-yr period

that includes five leap years. The above equation requires an estimate of the average of the highest waves in 12 hr of a year, which translates to 80 3-hr events in 20 yr of WIS summary table. The 12-hr annual average highest wave occurs with a frequency of  $(80/58,440)*100=0.14\%$ . By inspection of Table 3 to determine an average wave height corresponding to this percentage, the following estimates are made:  $H=3.6$  m and  $T=9.5$  sec at a hindcast depth of 18 m. Shoaling these waves out to deep water and neglecting refraction gives  $H_{0.12}=3.9$  m and  $H_{0.12}/L_{0.12}=0.0277$ . Substituting into Eq. 2 yields:

$$d_w = 3.9(2.3 - 10.9 * 0.0277) = 7.8 \text{ m}$$

From these calculations it can be seen that the berm needs to be placed within the 7.8 m contour to be considered an active part of the littoral zone and function as a feeder berm.

Utilizing the WIS yearly summaries and inputting them into the above Eq. 1 an estimate of the onshore-offshore movement of the sediment can be completed. To facilitate the calculation the program ON-OFF (Kraus 1990) was used. Input to the program includes, wave height and period, water temperature and depth at the location of the wave height, and sediment grain size. The fall velocity is calculated within the program. For the purpose of this exercise, sediment grain sizes,  $d_{50}=0.130$  mm, finest of the naturally occurring sands, and  $d_{50}=0.19$  mm, coarsest of the borrow material, were used. From the above criteria, the results for the coarser sediment where  $D_{50}=0.13$  mm, Water

Table 3. Percent Wave Occurrence, Galveston Island, Texas (WIS Station 11)

Height m	Wave*			Wave period (sec)							Total
	1.5	3.5	4.5	5.5	6.5	7.5	8.5	9.5	10.5	11+	
0.25	720	80	184	1	5	--	--	--	--	--	990
0.75	7671	17611	6153	1644	422	34	18	--	--	--	33553
1.25	41	13993	23141	6981	1442	77	20	--	--	--	45695
1.75	--	179	5542	8163	2551	59	8	1	--	--	16503
2.25	--	--	711	254	1587	100	1	--	--	--	2653
2.75	--	--	17	10	301	143	15	--	--	--	486
3.25	--	--	--	--	1	22	46	6	--	--	75
3.75	--	--	--	--	--	--	10	11	--	--	21
4.25	--	--	--	--	--	--	--	1	--	--	1
5+	--	--	--	--	--	--	--	--	--	--	0
Total	8432	31863	35748	17053	6309	435	118	19	0	0	

\* Calculated at 18-m depth; 58440 events; percent times 100.

Mean  $H_s = 1.1$  m; Largest  $H_s = 4.0$  m; Mean  $T = 5.6$  s.

Temp = 20° C,  $T = 5.6$  sec,  $H_o = 1.1$  m;

$$\frac{1.1}{0.0152 \times 5.6} = 13.32$$

Since the criteria, 13.32, is well above the prescribed 3.2, erosion or an offshore movement of the material should be realized. Similar calculations for  $d_{50}=0.19$  mm provide a criteria of 8.5, again indicating an erosion of the material.

Obviously this approach may be too simplistic for the Galveston Island area. According to the criteria used, all of Galveston's beaches would be under severe erosion. Although this is true in some cases, it is not true for the entire island. Most likely the problem of erosion prediction is within the wave data analyses. Waves were not refracted into the shoreline to determine their actual wave height when impacting the shoreline. A rigorous refraction diagram may indicate that waves are somewhat lower than predicted by the WIS study, this would in turn provide better criteria results for onshore movement. However, based on the analyses presented here, it is not recommended to construct an offshore berm with the material available without further study. The berm may break waves in the short term but would most likely provide no long term beach building.

## CONCLUSIONS

A methodology for evaluating the design and performance of a nearshore feeder berm for Galveston Island is presented. By evaluating site specific wave data, available sediment quality and quantity and construction equipment available a systematic approach to nearshore berm construction is made available. Two separate sediment types were evaluated for berm construction. By utilizing WIS hindcast wave data and the available sediment data a minimum depth of placement and potential performance could be determined. This exercise showed that the available sands were too fine and would not make a viable nearshore feeder berm. Additional study, or coarser material, would need to be identified before a feeder berm should be constructed at Galveston Island.

## REFERENCES

- Birkemeier, W. A., 1985. Field Data on Seaward Limit of Profile Change. *Journal of Waterway, Port, Coastal and Ocean Engineering*, 111: 598-602.
- Hallermeier, R. J., 1981a. Terminal Settling Velocity of Commonly Occurring Sand Grains. *Sedimentology*, 28: 859-865.
- Hallermeier, R. J., 1981b. A Profile Zonation for Seasonal Sand Beaches from Wave Climate. *Coastal Engineering*, 4: 253-277.
- Hallermeier, R. J., 1983. Sand Transport Limits in Coastal Structure Design. *Proceedings Coastal Structures '83*, American Society of Civil Engineers, pp. 703-716.
- Hubertz, J. M., and Brooks, R. M., 1989. Gulf of Mexico Hindcast Wave Information. Wave Information Study Report 18, U.S. Army Engineer Waterways Experiment Station, Coastal Engineering Research Center, Vicksburg, MS.
- Kraus, N. C., 1990. Prediction of Eroded Versus Accreted Beaches. Coastal Engineering Technical Note CETN-II-2, U.S. Army Engineer Waterways Experiment Station, Vicksburg, MS.
- Larson, M., and Kraus, N. C., 1989. SBEACH: Numerical Model for Simulating Storm-Induced Beach Change. Report 1: Empirical Foundation and Model Development, Technical Report CERC-89-9, U.S. Army Engineer Waterways Experiment Station, Coastal Engineering Research Center, Vicksburg, MS.
- McLellan, T. N., 1990. Nearshore Mound Construction Using Dredged Material. *Journal of Coastal Research*. SI 7:99-107
- McLellan, T. N. and Kraus N. C., 1991. Design Guidance for Nearshore Berm Construction. *Coastal Sediments '91*. ASCE. New York, NY. 2000-2011.
- McLellan, T. N., and Imsand, F. D., 1989. Berm Construction Utilizing Dredged Materials. *Proceedings of WODCON XII*, Western Dredging Association, pp 811-820.
- Nester, R. D., and Warren, P. J., 1987. The Effectiveness of a Twenty-Inch Dredge in Thin Layer Disposal. *Proceedings 19th Annual Dredging Seminar*, Texas A&M University, College Station, TX.
- U.S. Army Corps of Engineers. 1971. Report on National Shoreline Study. Washington, D.C.
- Williams, S. J., Prins, D. A., and Meisburger, E. P., 1979. Sediment Distribution, Sand Resources, and Geologic Character of the Inner Continental Shelf Off Galveston County, Texas. Miscellaneous Report No. 79-4. Coastal Engineering Research Center. Fort Belvoir, Va.

## THE MODIFICATION AND LAYOUT OF THE GALVESTON ISLAND GROIN FIELD

Y.H. Wang<sup>1</sup> and R.G. Barcak<sup>2</sup>

**ABSTRACT:** In the past hundred years or so, numerous groin fields have been constructed along the nation's coastline. Many of these have little or no existing beach in the groin field. This paper suggests a method for retaining sand in the groin field by moderately modifying the existing groin system. The application of this method is illustrated for the case of the Galveston groin field.

### INTRODUCTION

The project of beach nourishment in front of the Galveston Seawall calls for 15 to 20 million dollars. It is logical to explore avenues through which more economical ways can be found to retain a beach in front of the seawall. The idea at work here is to use the existing groin field. Thus modifying it in a way that the new groin system can perform more effectively for retaining sand than the existing groin field. By this moderate modification an economical solution to keep the nourished sand in place will exist.

To achieve this goal, the existing groin field is analyzed and a new concept is introduced for determining the modification. A general layout is provided for cost estimation purposes.

---

<sup>1</sup>Professor and Professional Engineer, Texas A&M University at Galveston, P.O.Box 1675, Galveston, Texas 77553-1675

<sup>2</sup>Research Assistant and Senior Student, Department of Maritime Systems Engineering, Texas A&M University at Galveston, P.O.Box 1675, Galveston, Texas 77553-1675

## **ANALYSIS OF THE EXISTING GALVESTON GROIN FIELD**

According to the Corps of Engineers' 1984 reports, waves in the Galveston area are mostly from the southeast and south directions (56% are from the southeast).

An analysis of the littoral transport directions indicates that sand placed between the existing groin elements will move in reversed directions depending on whether the incoming wave is from the southeast or the south.

- \* The placed sand between the groin elements will move in the southwest direction toward San Luis Pass when the groin field is exposed to southeastern waves. Figure 1 shows this general trend.
- \* The placed sand between the groin elements will move in the northeast direction towards Stewart Beach when the groin field is exposed to southern waves. Figure 2 shows this general trend.

These sand movements will result in the loss of placed sand between the existing groins, which calls for some modification of the groins so that placed sand will be retained. This will reduce the renourishment process in the future. The initial modification used for analysis was the reduction of spacing between groin elements.

## **REDUCTION OF SPACING BETWEEN GROIN ELEMENTS**

The spacing between groin elements in front of the Galveston Seawall is mostly around 1500 feet with a few shorter ones of 900 feet. Recent aerial photographs indicate that the short (900 feet) spacing has a marginal beach while the longer spans don't. This observation motivates the study of reducing the span between the groin elements. With this in mind a 500-foot long groin was inserted into all the existing long (1500 ft.) spans. The littoral transport direction was then determined. The analysis showed the similar trends to the existing groin field.

- \* The placed sand between groin elements will move in the southwestern direction, towards San Luis Pass, when the groin field is exposed to southeastern waves. However, there are two exceptions between groin numbers 6,7 and 2,3. Figure 3 indicates this trend.
- \* The placed sand between groin elements will move in the northeastern direction toward Stewart Beach when the groin system is exposed to southern waves. Figure 4 illustrates this general trend.
- \* The new groin construction is estimated to be 6000 feet.

As shown by these figures, placement of intermediate groins between the long spans gives results similar to the existing groin system, although transport rates differ. By this analysis a different modification approach was studied as follows.

## CONCEPT OF MODIFICATION

Along a sandy straight shoreline, for a given dominate incoming wave, the littoral transport direction can be determined. The concept introduced here is that for a given incoming wave, the littoral transport direction can be manipulated to reverse its normal transport direction and the transport rate can also be reduced or increased. This concept is illustrated in Figure 5. By using this concept a new idea for the modification for the groin field is analyzed.

## THE MODIFIED GROIN SYSTEM

The concept (Figure 5) is utilized to mainly slow down the sand movement in the southeast direction; illustrated in Figures 1 and 3. Considerations are also given to incorporate the littoral transport due to southern waves (Figures 2 and 4) and waves from directions other than southeast and south directions. Notice the slanted T and L additions which are optimized using incoming wave angles. A preliminary layout of the modified groin system is presented in Figure 6.

The highlights in Figure 6 are listed below:

- \* The net direction of littoral transport are kept to a minimum compared to Figure 1 through 4.
- \* The length of new groin construction is 4285 feet compared to the length required in Section 3 of over 6000 feet.
- \* The waterline marks the expected size and shape of the sand beach between the groin elements.
- \* The slanted T-shape and L-shape groins are used to retain the placed sand within the groin elements.

## CONCLUSION

From this analysis, the following conclusions can be summarized.

- \* Placement of sand within the existing groin field results in sand movement towards San Luis Pass with southeast wave direction.
- \* Placement of sand within a groin system with shorter spacings (groin every 900 feet or less) also results in sand movement towards San Luis Pass during southeast waves.
- \* Placement of sand within the modification of the existing groin system (Fig.6) shows a reversal, which helps keep sand in place during southeast waves.

## REMARKS

The layout of the modified groin system needs an initial nourishment of sand from an external source, it is not meant to be used to collect sand but to retain the placed sand between groin elements. If the layout is adopted, the refined calculation must be done on: (1) the orientation of the Ts and Ls of the groin tips, (2) the length of the existing groins and the groin tips, (3) more incoming waves other than southeast and south directions need to be analyzed for transport direction and intensity.

Since this report examines the situation based on wave direction alone, the final design of this groin system should include refraction analysis, taking into account breaker height and other conditions.

## LIST OF FIGURES

- FIGURE 1 Groin System with SE Waves
- FIGURE 2 Groin System with South Waves
- FIGURE 3 Short Span System with SE Waves
- FIGURE 4 Short Span System with South Waves
- FIGURE 5 Effect of Groin Orientation on Net Drift
- FIGURE 6 General Layout of Modified Groin System



Figure 1 Existing Groin System with Southeast Waves

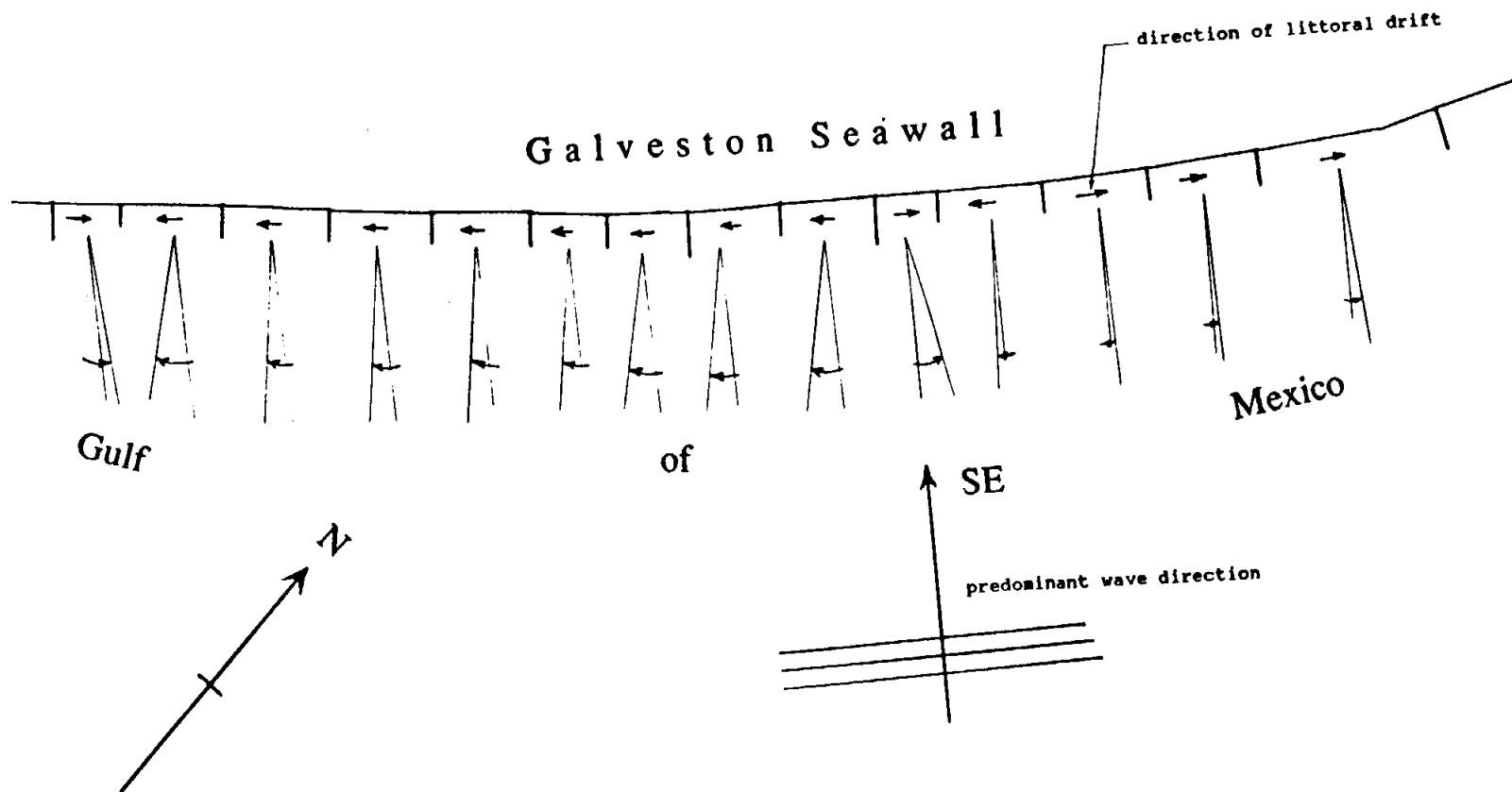

Figure 2 Existing Groin System with South Waves

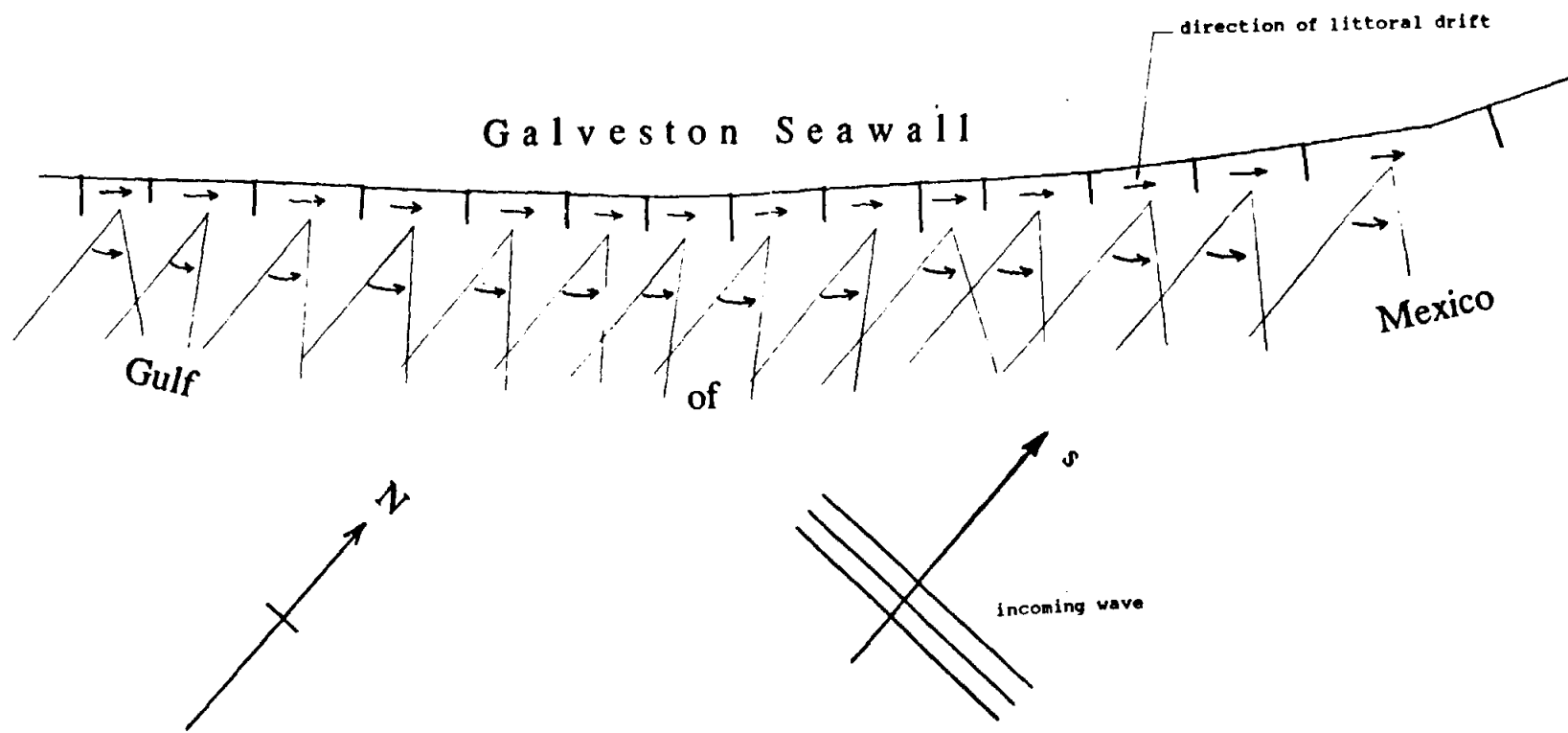
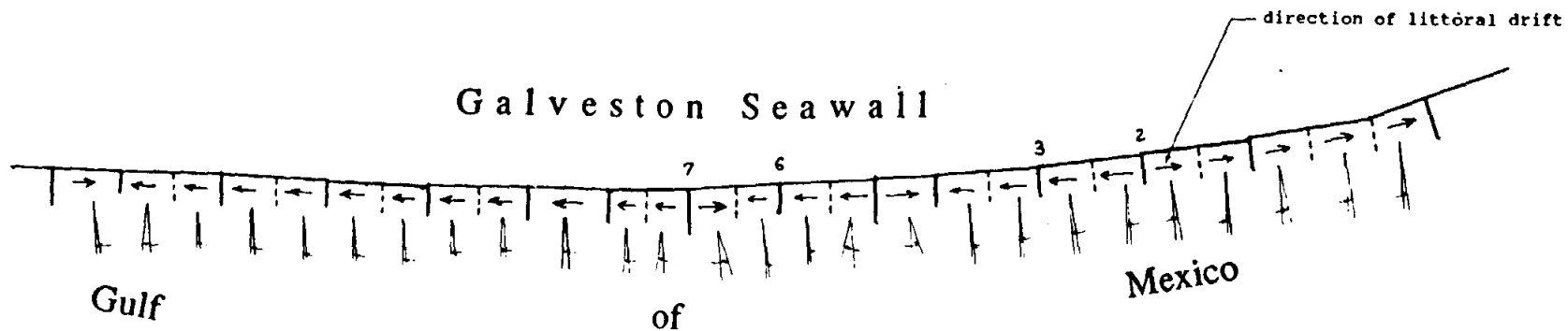
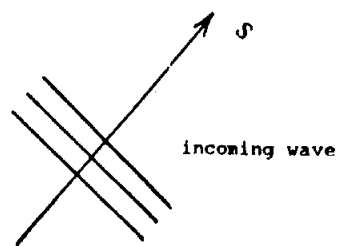
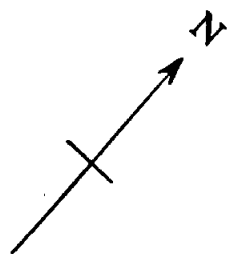
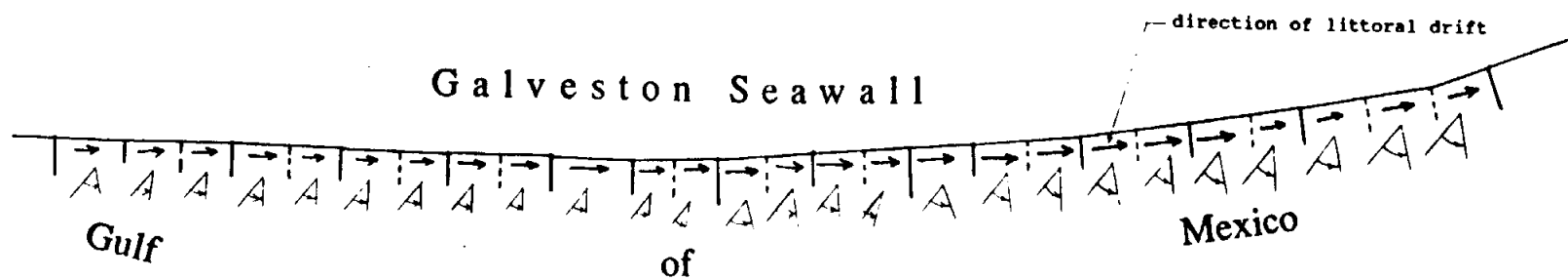

Figure 3 Short Span Groin System with Southeast Waves



\* dashed lines are inserted groins of 500 feet in length

Figure 4 Short Span Groin System with South Waves



\* dashed lines are inserted groins of 500 feet in length

# Effect of Groin Orientation on Net Drift Direction

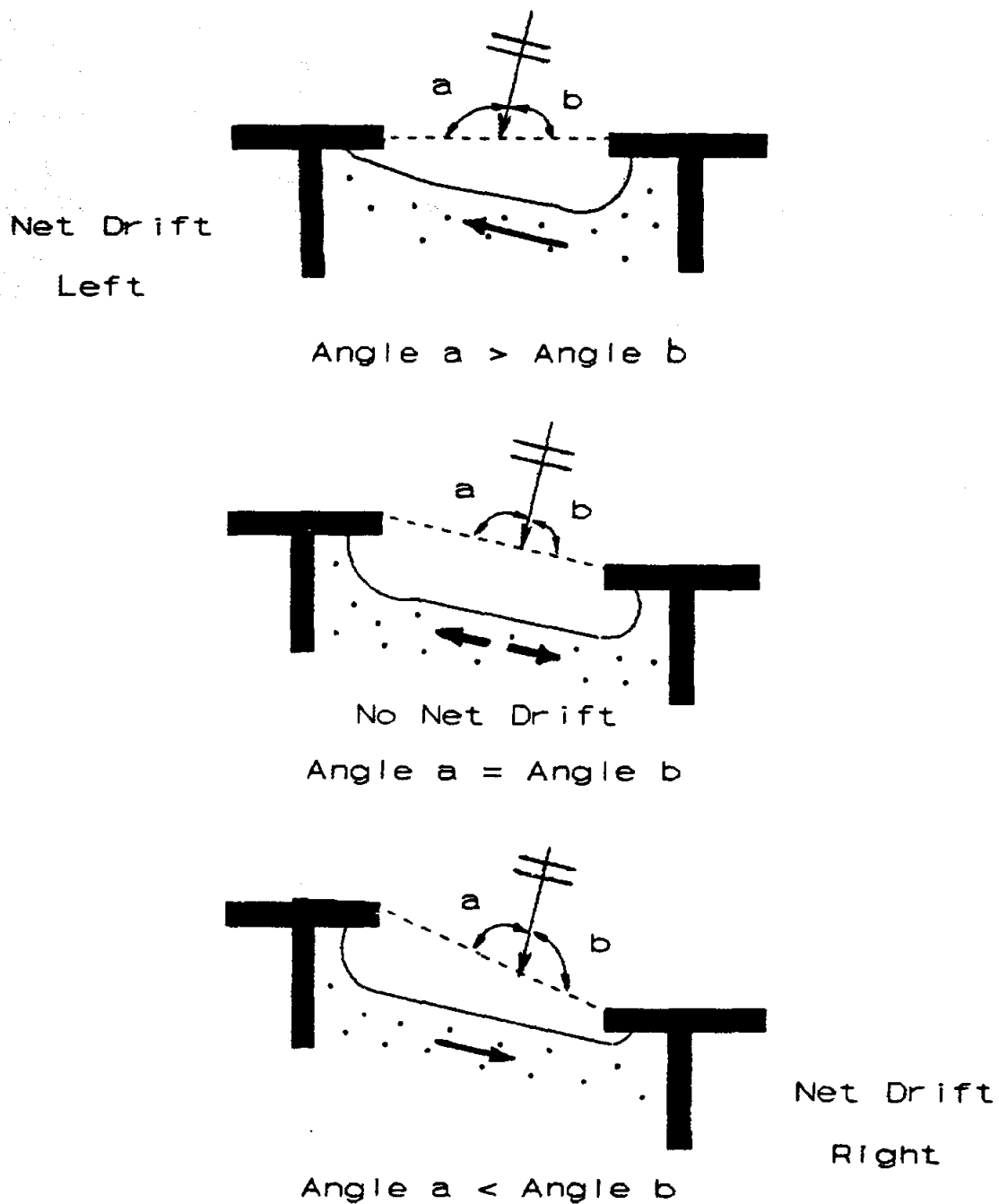
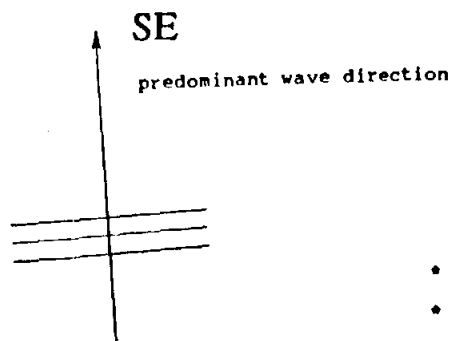
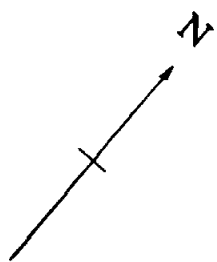
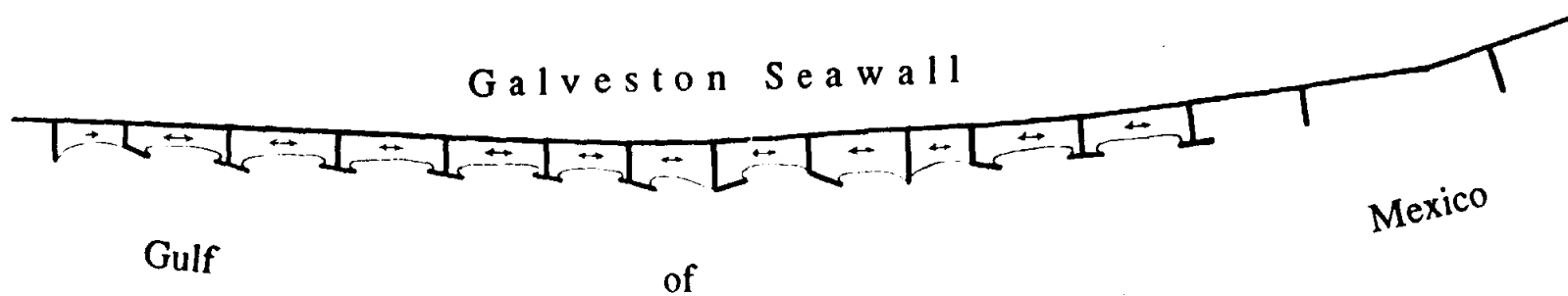

Figure 5

Figure 6 General layout of modified groin system



- openings between groin elements are 900 feet
- Ts and Ls are slanted with varying angles

## DUNE RESTORATION ALONG GALVESTON WEST BEACH

Yu-Hwa Wang\*

**ABSTRACT:** The City of Galveston is protected from storm attack by the Galveston Seawall while the Galveston west beaches are vulnerable during a severe storm such as hurricanes. This paper suggests an efficient, low-cost and least environment-impact method to prevent coastal flooding and land/property losses on Galveston west beaches during storms.

### INTRODUCTION

In 1989, the Galveston shoreline was severely eroded by two hurricanes and one tropical storm. State highway 87, which runs parallel to the coastline between Galveston and Port Arthur, has been closed to traffic due to severe erosion. To relocate highway 87 inland would be at the expense of filling-in the coastal wetlands, not to mention the cost of a new coastal highway. Similar situations have been in existence for a long time along the Louisiana coastline. The Louisiana approach is to build a series of offshore breakwater segments to slow down the erosion for saving the highways and wetlands. The shoreline stabilization techniques such as offshore breakwater and beach nourishment have their merits, however, during a storm, as the sea level rises, both offshore breakwaters and the nourished beaches will be submerged. The higher storm sea level will flood the highway and allow waves to attach the coastal highlands, thus, resulting in land and property losses. This paper suggests an efficient, low-cost and least environment-impact method to prevent coastal flooding and property losses on Galveston west beaches.

---

\*Professor and Professional Engineer, Texas A&M University at Galveston, P.O.Box 1675, Galveston, Texas 77553-1675

## THE CONCEPT

The fundamental basis of finding and placing compatible sand along the coastal shoreline for dune restoration involves the concept of an equilibrium beach profile.

Energy input (wind, wave, current and tide) to the coastal zone is expended to shape the nearshore boundary configurations. For a given energy level, the bottom material acts and reacts with various governing forces in the coastal zone to reach an equilibrium bottom profile corresponding to the energy level. There are two major mechanisms through which the equilibrium bottom profile is reached, namely, accretion and erosion. When the beach accreting phase is identified, a thin layer of sand on the beach is scraped away by a road grader; the natural forces will then act to restore the beach profile, thus, moving sand ashore. By repeating this process, large volumes of sand can be obtained for dune restoration.

These sands are then placed along the dune line and held there by sand fences and vegetation to form a continuous dune line with dimensions (height and width) compatible with the local environment. During a storm, the sea level rises and waves reach to the dune line and the wave energy is expended to return the dune sand to the beach and offshore bars. After the storm, the "Nature-Assisted Dune Restoration" procedures start and a continuous dune line is to be restored ready for the next storm, thus, an operational cycle is completed.

It is to be emphasized that this procedure is a closed operational system and no sand will be moved out of the littoral system. Sand is placed where it is needed and when it is needed. This operational process utilizes wave energy to send sand ashore replacing offshore dredging. This method simulates the natural dune formation process by adding sand to the dune a little at a time, however, it contracts the time from years to months.

## LABORATORY EXPERIMENTS

The aforementioned concept was formulated in the middle 1970s when John Davenport, Morton Smutz, and Yu-Hwa Wang met to discuss the beach maintenance technique at Biscayne Bay, Florida. Later, John Davenport supported laboratory investigations which were carried out by two graduate students under Wang's supervision [1, 2, 3].

The first laboratory study was conducted in 1977 and its results were reported in 1978. An eleven by fourteen meter wave basin was used for the study. The testing procedures are re-described [1, 7] as follows.

1. A thin layer (30 mm thick) of natural Florida fine sand with a mean grain diameter of 0.2mm was placed on the basin floor. A smooth plan beach with an uniform slope 1 on 30 was created at one end of the test basin.



2. Wave with height of 25.4 mm, period 1.9 seconds were generated at the end of the wave basin opposite to the plan beach.
3. As the waves were generated and propagated toward the uniform sandy beach, a breakerline was observed near the beach area. Observation of changes on the bottom configurations were (i) the formation of sand ripples on the entire basin bottom area, (ii) presence of sand bars in the nearshore region, (iii) changing of beach face slope, (iv) and the formation of a beach berm. After eight hours running time, the nearshore bottom configuration appeared to have reached a quasi-equilibrium state with a definite foreshore slope.
4. Sand was then removed by gently scraping off a thin layer of sand from the berm and the foreshore slope area. The removed sand volume was measured.
5. The subsequent removal was carried out only if the beach were restored to its quasi-equilibrium configuration after the sand removal. In one experiment, 19 consecutive removals were made. Every time, after the removal, the sand was consistently pushed ashore by the 25.4 mm waves to make up the quasi-equilibrium beach profile.
6. The time between two removals was purposely varied to see whether or not the beach face slope might vary with respect to time exposure to waves. Some longer runs exceeded 24 hours. For the 19 consecutive removal experiment, the total running time was 350 hours. It was observed that the modified beach profile would be restored to its quasi-equilibrium configuration in four or five hours in most runs.
7. The total sand volume removed in the 19-removal experiment was measured as approximately one cubic meter for a 25.4 mm wave over a total time period of 350 hours (including some longer runs).
8. A close observation of the processes revealed that when the slope was flatter than the quasi-equilibrium profile (i.e. after the sand removal from the beach), sand pushed up on the beach slope by waves would deposit; when the quasi-equilibrium profile was reached, the beach building process became self limiting, because the wet sand particles rolled back down the quasi-equilibrium slope as fast as they were pushed up by waves. This process could be likened by the phenomenon that dry loose materials roll down a slope when the static angle of repose has been reached.

The encouraging results from this first experiment led to a second laboratory study [2, 3] in which the tests were carried out with two wave steepnesses (0.0056 and 0.0293) and three beach slopes (1 on 11.1, 1 on 16.6 and 1 on 33.3). The wave basin used was also larger (15 meter by 23 meter). A statistical analysis of the collected data indicated that the correlation between sand accumulation, beach slope, and wave steepness was coherent and good. This second experiment reaffirmed all the findings of the first experiment.

## FIELD EXPERIMENTS

A field experiment was carried out by Per Bruun at Hilton Head Island, South Carolina. The wash-up surplus material on the lower beach face is removed by a scraper and placed on the backbeach face as a measure for stabilizing the beaches. The suggested scraping area had a depth of one foot and a width of 100 feet. This field experiment was reported in an article titled "Beach Scraping - Is It Damaging to Beach Stability?" [5] In his article, Per Bruun concluded that beach scraping was not harmful to beach stability and had beneficial effects on adjacent beaches. He further stated that beach scraping is a way of organizing available beach material in a more sensible way.

Another field experiment to determine the response of natural beaches to artificial manipulation by sand scraping was carried out at Myrtle Beach, South Carolina by T.W. Kana and M. Svetlichny [6]. Like Per Bruun's experiment, sand on the lower beach face was removed and placed onto backbeach face. The results of this experiment were mixed and depended on the backshore preconditions. Nevertheless Kana and Svetlichny stated that from an aesthetic as well as cost standpoint it should be considered as a shore protection option.

In 1984, the oil spill from the tanker Alvenus washed onshore along the entire gulf shoreline of Galveston Island. The tidal zone was blackened with thick layers of crude oil. The clean-up technique used was repeated removal of tar sand from the beach when the oil arrived. The removal was done by scraping away a layer of tar sand with front loaders and then trucked away. The effects of the Alvenus oil spill clean-up technique on beach profiles were studied and reported in reference [4].

A recent field experiment was carried out by Wells and McNinch at Topsail Beach, North Carolina [7]. They concluded that on the annual time scale, scraping was effective and beneficial, however, it may be ineffective for a strong storm such as hurricane Hugo. They also counter argued that without scraping, the loss of sediment could have been even greater during the passage of hurricane Hugo. The success or failure of a scraping project may depend almost solely on how the scraping is carried out in terms of location and size of the borrow and fill sites, and the volume and rate of sediment removal.

Field experiments conducted at Hilton Head Island, Myrtle Beach, and Topsail Beach were aimed at beaches. They revealed the response of a natural beach when the equilibrium conditions were altered. Per Bruun reported that no harm will be done to beach stability but it is only a temporary measure. Kana and Svetlichny said that the scheme is at best temporary. Wells and McNinch postulated that beach scraping may not be effective during strong storms. Their statements are logical consequences when examined under the context of the equilibrium beach profile concept. Sand moved from one part of the beach and then placed on another part changes the equilibrium profile; the natural forces will move the placed sand away and return to its equilibrium profile, thus, making the manipulation temporary.

## NATURE-ASSISTED DUNE RESTORATION

The harmless but temporary nature of beach profile manipulation did not perform well for widening the beach at Hilton Head Island, Myrtle Beach and Topsail Beach. However, it still can be a very valuable tool for dune restoration. The restored duneline was meant to be destroyed by storm tides during a hurricane. However, the land and the developments behind the duneline would be saved. This dune restoration procedure is repeatable and economical.

Instead of making dune restoration a concentrated one-time effort, it is suggested to make it a regular event to be integrated into beach cleaning and maintenance programs. Many coastal counties already have a beach maintenance program in place. The beach scraping operation proposed by Per Bruun had a scraping area 100 feet in width and one foot in depth. A single operation will produce eleven cubic yards per one yard beach front length. The scraping area at Myrtle Beach was also extensive. To avoid these severe alterations of beach configuration, it is proposed to scale down the scraping area to fifteen feet wide and three inches deep [8]. The concentrated one-time operation is also broken up into multiple operations by a beach maintenance crew. The reason for these suggested changes is given in the following. The summer ridge profile in Figure 1(a) of Bruun's paper is reproduced on the following figure.

When this equilibrium profile is reached, wave energy will still be spent to continue moving sand around in a way that sand rolls down the beach slope as fast as the uprush can push it up. It is this excess drifting sand rolling up and down the equilibrium beach slope to be captured and placed on the duneline, not the sand already in the equilibrium beach profile. To catch these drifting sands, the equilibrium profile is gently tipped off by scraping a thin layer of sand (3 in. deep, 15 ft. wide); the excess drifting sand will fill the scraping area within one tidal cycle. A large volume of natural selected beach sand may be obtained by repeating the scraping procedure, at the same time, the beach profile is not severely altered and kept in tact for beach visitors during operations. The scaled down field scraping procedures, suggested by Wang and shown in Figure 1(b), may be found in reference [8].

# Nature-Assisted Dune Restoration (NADR)

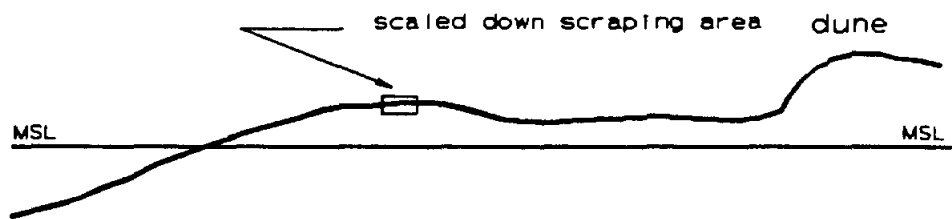
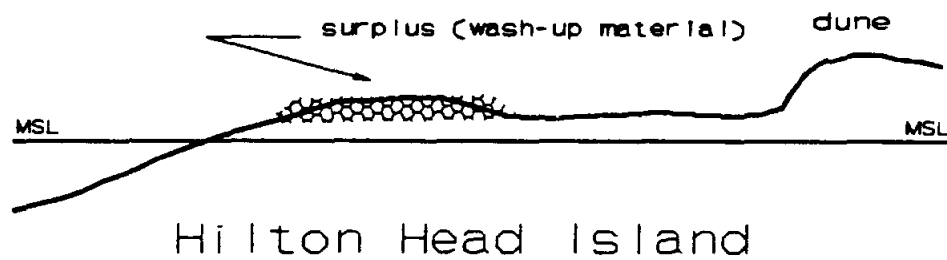

NADR - Scaled down scraping area

## LONG-TERM EFFECTS AND CONCLUSION

It has long been the concern of geomorphologists that a continuous duneline blocks overtopping and prevents oceanic overwash, therefore viewed as a threat to barrier island stability and migration. A recent study by Leatherman [9] concluded that overwash is not the dominant process. Far greater quantities of sediment move into bays through old and new tidal inlets. Since the restored duneline is meant to be destructed by storm tide returning sand to the beach and offshore bars, the establishment of a continuous duneline can contribute to the stability of beaches as well as saving coastal properties. The use of the beach scraping method to catch the excess drifting sand on an equilibrium beach slope for dune restoration is feasible. This method simulates the natural dune formation process and uses wave energy to send sand ashore. The operational procedures can be part of a regular beach maintenance program. It is cost-effective and has minimal environmental impact.

## REFERENCES

1. Smutz, M., Leadon, M.E. and Wang, Y.H., "Summary Report for the Dredging Seminar", DREDGE SEMINAR, Miami Beach, Florida, 1978, pp. 170-175
2. Griffith, J.W., "Nature Assisted Beach Enhancement", M.S. Thesis, Department of Coastal and Oceanographic Engineering, University of Florida, 19179, 60 pages.
3. Smutz, M., Griffith, J.W., and Wang, Y.H., "Nature Assisted Beach Enhancement, or Sisyhus vs Zeus", Journal of the American Shore and Beach, Vol. 48, no. 2, April 1980, pp. 32-36
4. Wang, Y.H., "Effect of the Alvenus Oil Spill clean-up Technique on Beach Profiles, Galveston, Texas", Proceedings, Ocean '85, San Diego, California, 1985, pp. 568-573
5. Bruun, Per, "Beach scraping - Is It Damaging to Beach Stability?" Coastal Engineering, Vol. 7, 1983, pp. 167-173
6. Kana, T.W. and Svetlichny, M., "Artificial Manipulation of Beach Profiles" Coastal Engineering, 1982, pp. 905-922
7. Wells, J.T. and McNinch, J., "Beach Scraping in North Carolina with Special Reference to its Effectiveness During Hurricane Hugo" Journal of Coastal Research, Special Issue No. 8, 1991, pp. 249-261
8. Wang, Y.H., "A Cost-effective Beach Building and Maintenance", Proceedings Oceans '82, Washington, D.C., 1982, pp. 980-983
9. Leatherman, S.P., "Barrier Island Handbook", laboratory for Coastal Research, University of Maryland, College Park, Maryland, 3rd Ed. 1988, 92 pages.

**THE USE OF VISCOUS DRAG MATS  
TO  
PREVENT SHORELINE EROSION**

**Peter Alsop\***

**ABSTRACT:** A viscous drag mat system can be implemented for combating shoreline erosion for specific areas with predetermined results. Sediment particles are manipulated so that a buildup occurs providing a reinforced soil bank. The use of these mats have numerous advantages over other protection methods.

---

\* President, Hydracor International, Inc. 1725 Duke Street, Suite 680, Alexandria, Virginia 22314

## **Introduction**

The "Viscous Drag Mat" was designed to have a very high resistance to flow so that it could be applied to reduce wave and current energy. In addition, it had to be easily installed, cost effective, and reliable.

The "viscous drag" component of the mat is manufactured out of a specially formulated propylene polymer. This polymer offers both a specific gravity of .87, a significant improvement in polymer design, and a high tensile strength.

In order to achieve a very high density of buoyant tapes, a novel manufacturing process had to be developed. This allowed us to produce a mat that, when fully deployed on sea-bed, could achieve a tape density of up to one 1" x 5'3" tape per square inch. This would present a total wetted drag area of 3.8 million square inches uniformly distributed within 1109 cubic feet.

Under water, the side face of the mat presented to the water current entry yields and the water velocity is then progressively diminished as the tapes, through the body of the mat, exert a continuous drag force on the current. The mat, in its installed position, is designed to accommodate water currents from any direction. As the velocity of the current is reduced within the confines of the mat, carried sediment particles lose their flight mode and settle within the mat tapes, eventually building up into a highly cohesive reinforced soil bank.

## **Anchoring System**

Permanent retention of this high profile mass of buoyant tapes to the seabed is achieved through the use of a novel anchor. Each mat is anchored into the sea bed with 24 of these ground anchors. The anchors are driven in pairs to a depth of four feet. Each anchor in the pair has a minimum retention capability of two tons. Each mat, installed underwater in silty-sand, will have a minimum non-gravitational hold down of 48 tons.

Once installed, the mat will develop into a soil bank approximately five feet high with a base measuring 16.25 feet by 13 feet. This soil bank alone will weigh approximately 50 tons.

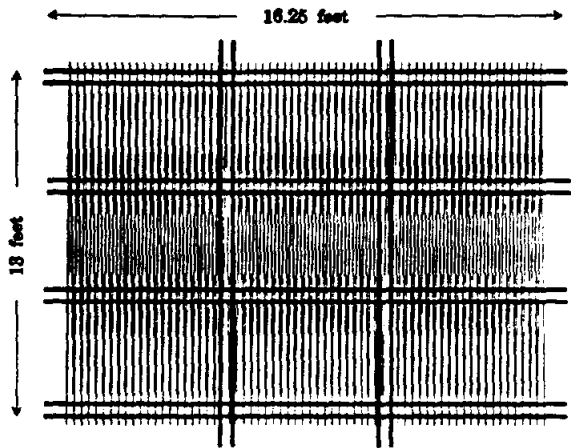

Bottom View of The Viscous Drag Mat Illustrating the Anchor Strapping Pattern. At the end of each strap pair, a pair of ground anchors is attached and driven down four feet.

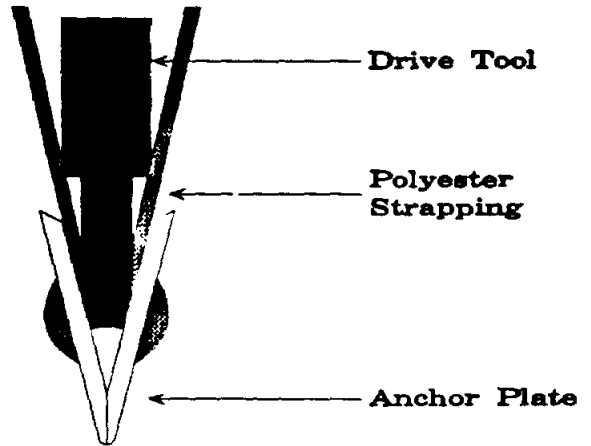

Anchor Pair Bent Into Driving Position. As tension is applied to the anchor pair, it will open up and split into two separate plates.

### Product Life

The mat has been designed for a long buried life. In meeting this requirement, the propylene polymer used for the buoyant tapes has been found to have little to no change in physical characteristics after twenty years burial.



## Installation

Installation in deep water is carried out by divers using a "dispenser" allowing a standard 5 meter (16.25') length mat to be installed on bottom within five minutes (10 meter/33.5' length mats can also be accommodated).

In shallow water an amphibious vehicle with a diver standby would be used, and runs of thirty meter (97.5') mats would be installed. Shorter runs could also be accommodated.

I would describe the reinforced soil bank generated by the mat as an "Engineering Tool" that could be applied in shore protection. Off shore breakwaters, shore connected breakwaters, jetties, and groins name but a few of the possible applications. In some cases the mat is used as a foundation, and others to form the entire structure.

## Advantages

I consider the following advantages as important considerations.

1. The system is environmentally acceptable. The European Fishermen recommend its use; it is inert and attracts fish through all stages of development including the finally formed bank. Whereas in my experience, the use of dumped stone can drive fish from their habitat for periods of up to two years.

2. The system is totally inert and will not contaminate the water. It does not adversely effect any marine life or vegetative growth.

3. The finally formed bank is not rigid in structural terms. It contour-follows the bottom profile and blends into the seabed, its shape fashioned by the current.

4. Soil particles settling within the mat are subject to vibration transmitted by the buoyant tapes agitated by the current. This results in an extremely high degree of soil compaction.

5. The mat is immediately effective on deployment.

6. The mat does not require any follow up maintenance, nor is it a sacrificial system requiring periodic nourishment.

7. It also has a significantly lower installation cost when compared to traditionally used systems.

### Breakwaters

In the course of carrying out a documentary study of coastal protection structures, I have established that the offshore breakwater, when correctly applied, displays the highest level of beach accretion. Failures recorded could be categorized under two headings, positional and structural.

In the case of position (location on bed), the results achieved were other than the primary engineering requirement. In other words, accretion and depletion of soil took place in the wrong zones. Not always a complete disaster, dredging and the introduction of additional diversionary structures were used as corrective mechanisms.

Structural failures such as breaching and collapses due to current, wave energy, and scour occurred frequently. Cost had obviously dictated design, which had a direct effect on the stability and life of the structures. Well designed structures, armored and monolithic in characteristic, survived and proved to be good for purpose in performance.

The argument not to use the offshore breakwater because it creates local accretion and causes depletion elsewhere as a result of diverting soil from long shore sediment transport should not in any way mitigate against its use. It is my opinion that only a small percentage of the long shore transported sediment would be retained locally, and the onshore wave-carried sediment would be the major contributor to the beach until a state of "soil build-up" equilibrium is attained.

## Appendices

- Appendix A**      **Erosion Susceptibility Chart**
- Appendix B**      **Formation of an Underwater Reinforced Soil Bank**
- Appendix C**      **Viscous Drag Mats Used To Create an Underwater Berm**
- Appendix D**      **Photographs of The Viscous Drag Mat System**
- Appendix E**      **Viscous Dag Mat Installations**

# Erosion Susceptibility Chart

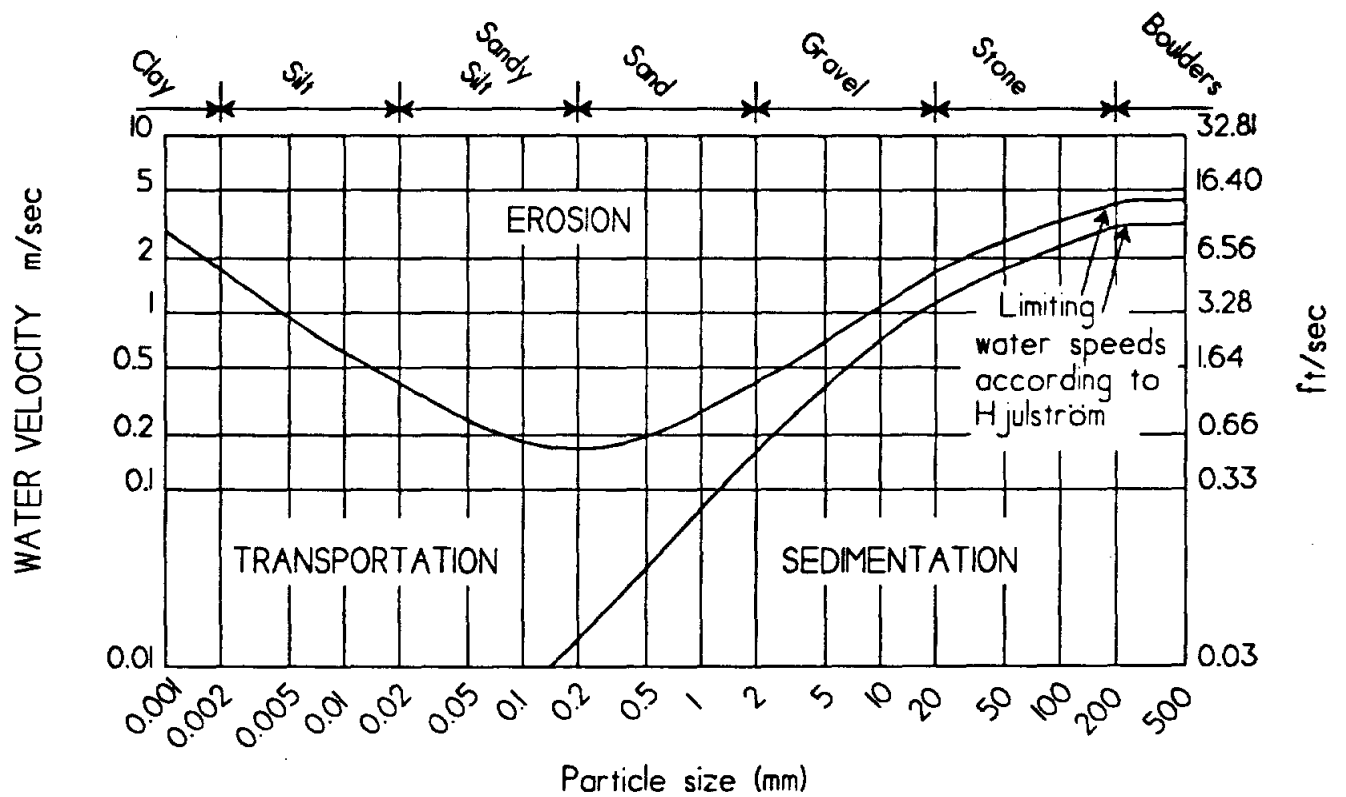

Erosion Susceptibility in Relation to Water Velocity and Particle Size

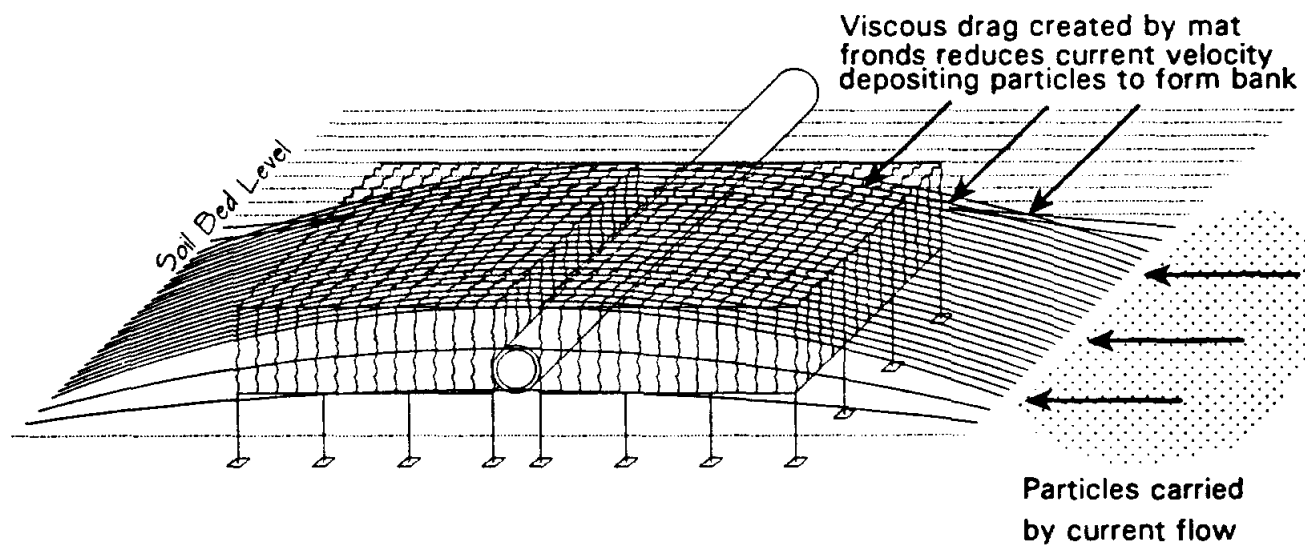
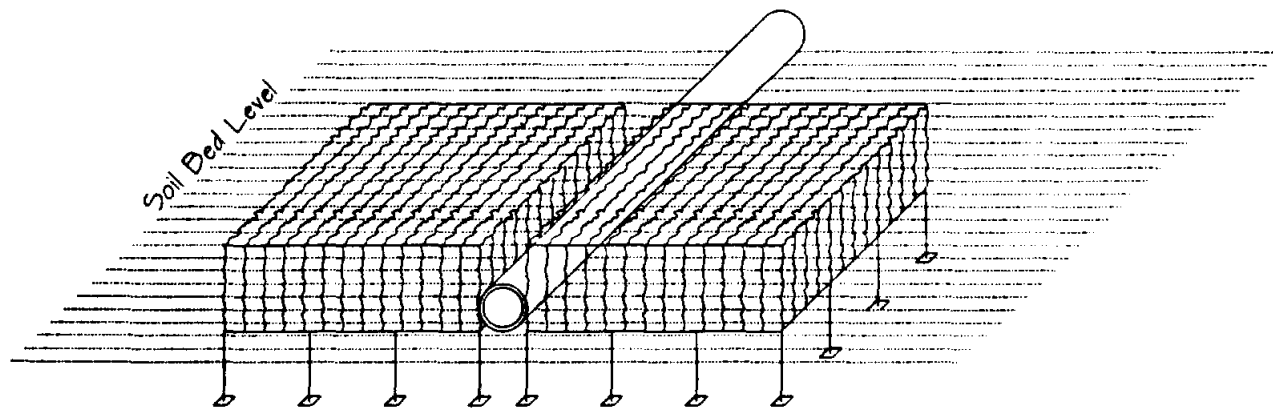

**2 Erosion Control "Mats" Surrounding a Pipeline.  
Underwater Viscous Drag to Reinforced Soil Bank.**

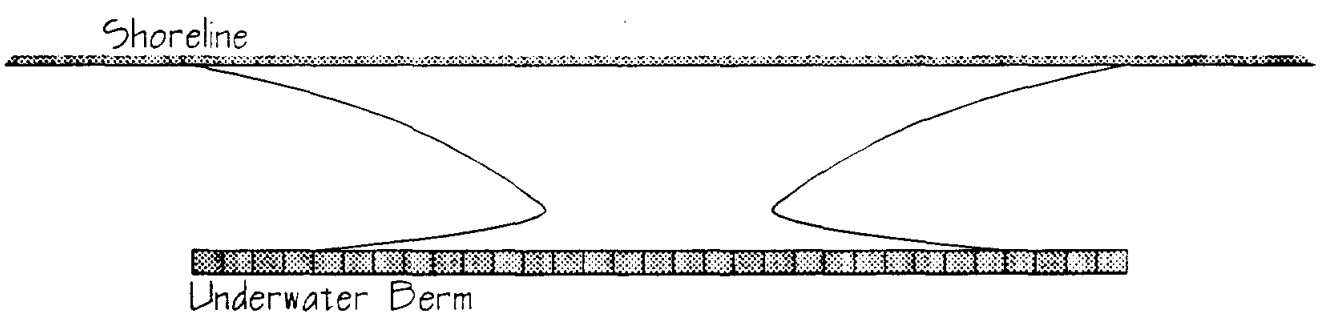
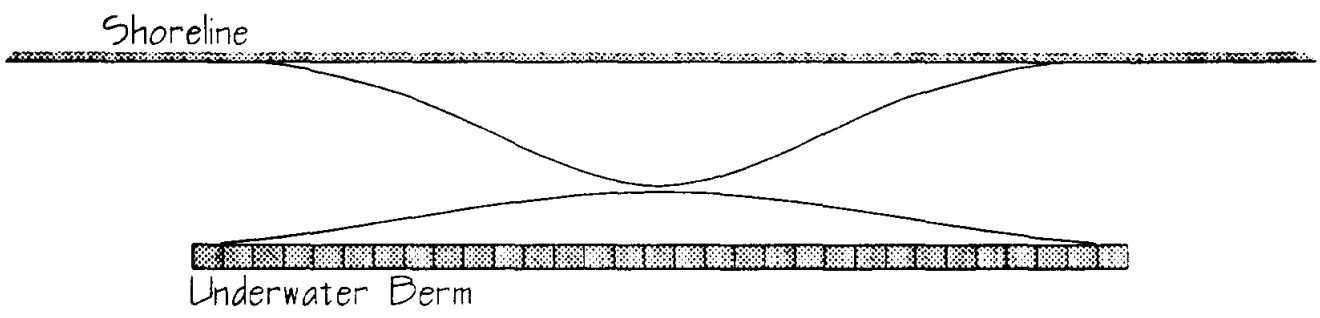
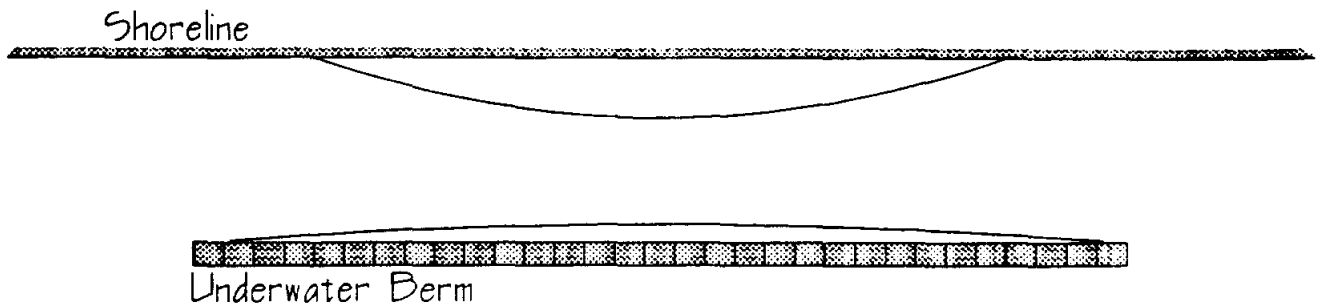

**Stages in the Growth of a Tombolo Sand Bar.  
Plan View.**

**Erosion Control "Mats" Used to Create an Underwater Berm Inducing the "Tombolo" Effect.**

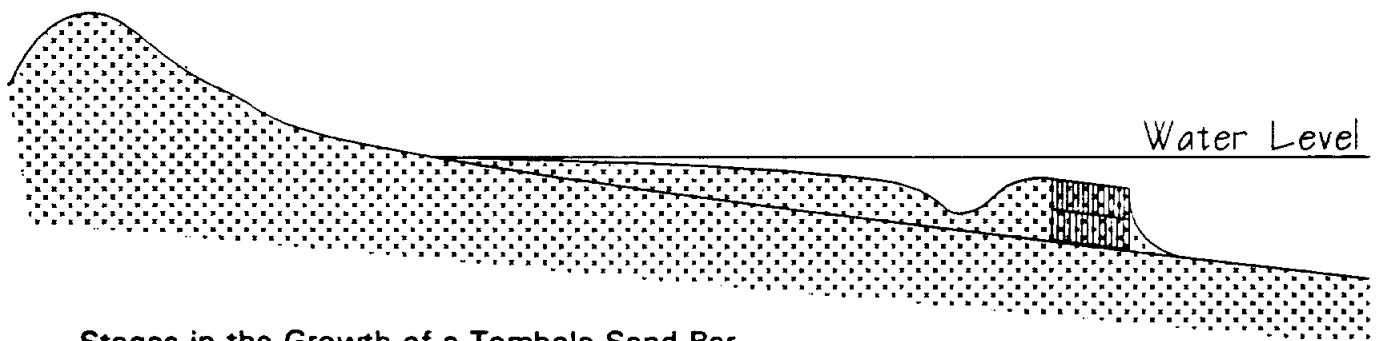
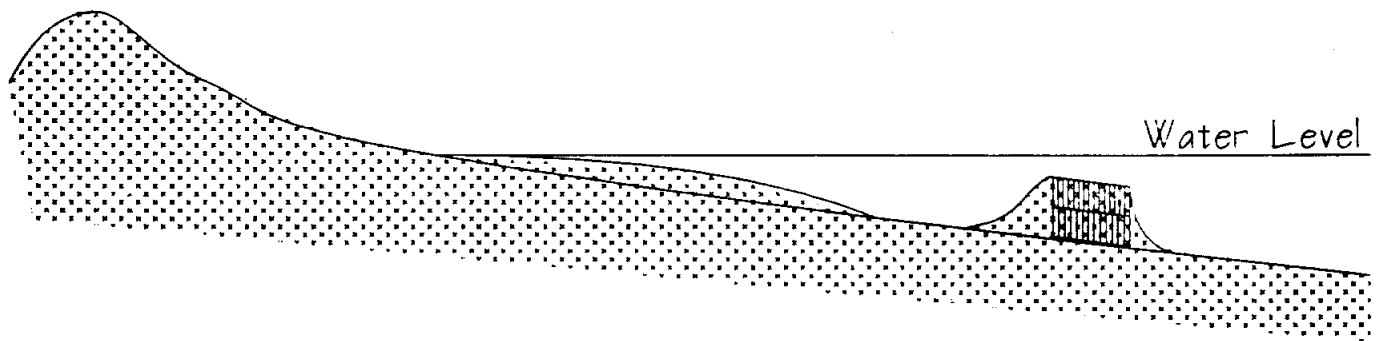
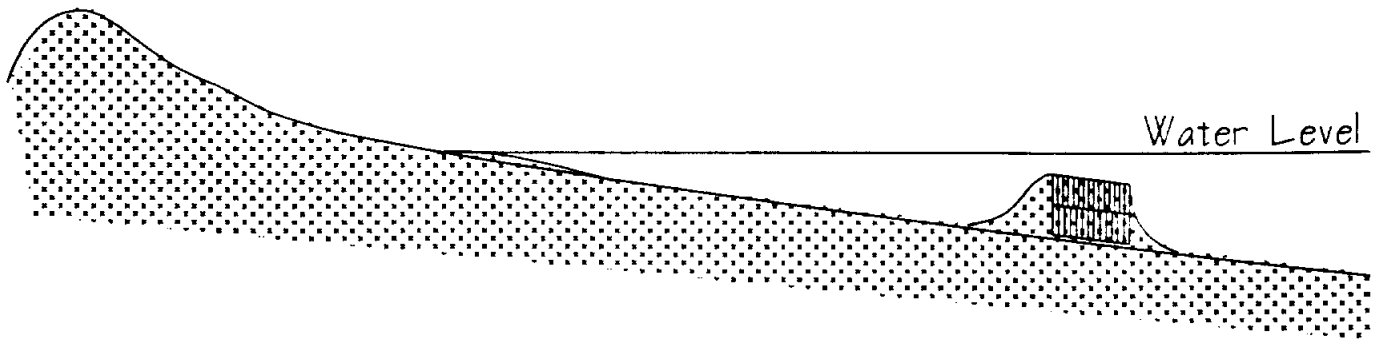

**Stages in the Growth of a Tombolo Sand Bar.  
Side View.**

**Erosion Control "Mats" Used to Create an  
Underwater Berm Inducing the "Tombolo" Effect.**

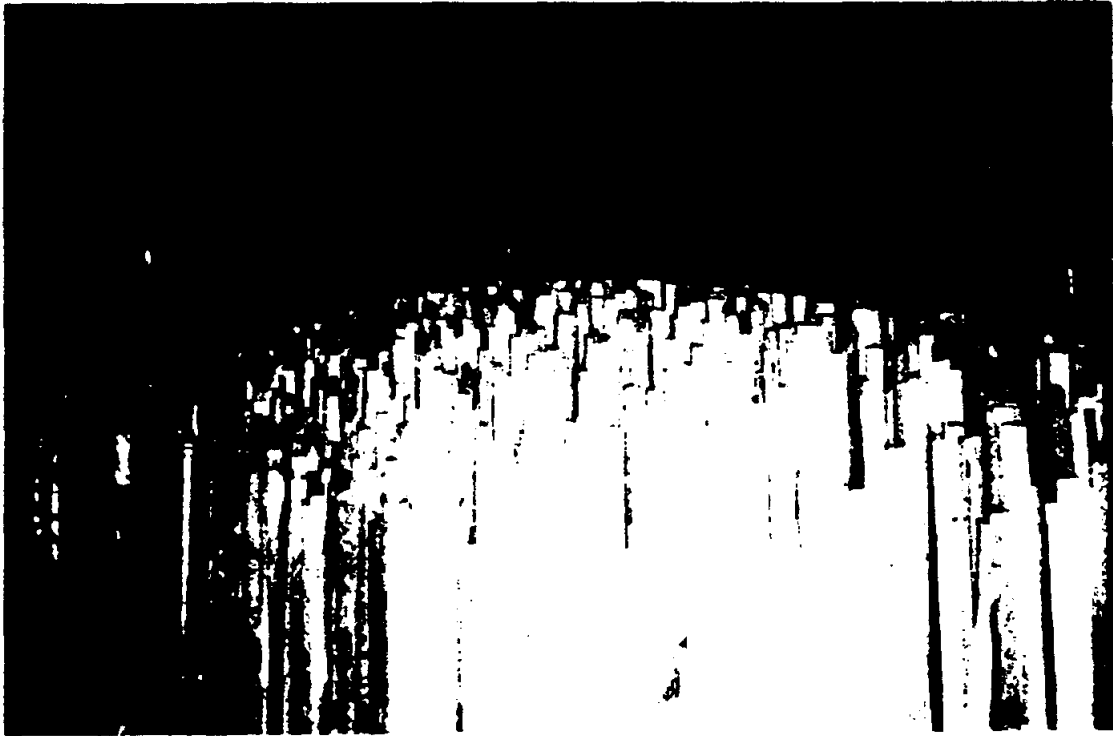

Viscous Drag Mat — Oblique View





Ground Anchors



Reinforced Soil Bank -- 6 years

Leman Field, Southern North Sea, Europe

Note: Abundance of Normal Marine Life

### Erosion Control Mat — Installations

Date	Client	Application / Location
May 87	Conoco	Jack-Up Rig Scour Correction - Valiant Field
Jul 87	Shell	Cable-pipeline Crossover Protection & Stabilization - Leman Field
Jul 87	Conoco	Pipeline Free Span Correction - Viking Field
Aug 87	Amoco	Jacket Scour Correction - Leman Field
Oct 87	Shell	Pipeline Free Span Correction
Dec 87	Shell	Jacket Scour Correction - Sean RD
Mar 88	Pennzoil, Holland	Jack-Up Rig Scour Correction - Dutch Sector
Apr 88	Shell	Jack-Up Rig Scour Correction - Leman Field
May 88	Pennzoil, Holland	Jack-Up Rig Scour Correction - Dutch Sector
May 88	Shell	Jack-Up Rig Scour Correction - Morecambe Bay
Jun 88	Amoco	Jacket Scour Correction - Leman Field
Jun 88	BP	Sub Sea Housing Stabilization - Ravenspurn Field
Jun 88	Conoco	Pipeline Scour Remedial Installations - 'V' Fields
Jun 88	BP	Spool Piece Free Span Correction - Ravenspurn Field
Jul 88	Scottish Electricity	Power Cable Stabilization Trials - Isle of Skye
Jul 88	BP	Jacket Scour Correction - Cleeton Field
Jul 88	Hamilton Bros.	Pipeline Free Span Correction - Esmond Field
Jul 88	BP	Jacket Scour Correction - Ravenspurn Field
Aug 88	British Nuclear Fuels	Pipeline Stabilization Trials - Sellafield
Aug 88	Hydrocarbons GB	Pipeline Free Span Correction - Morecambe Bay
Aug 88	Shell	Jack-Up Rig Stabilization - Leman Field
Sep 88	Hydrocarbons GB	Pipeline Stabilization - Morecambe Bay
Sep 88	Waveny District	Wave Energy Reduction - Corton Beach
Sep 88	Amoco	Pipeline Span Correction & Stabilization - Indefatigable / Leman Fields
Sep 88	Shell	Pipeline Stabilization - Leman Field
Sep 88	Phillips	Spool Piece Stabilization - Della Field
Oct 88	Mobil	Jacket Stabilization - Camelot Field
Oct 88	Phillips	Spool Piece Stabilization - Della Field
Nov 88	Shell	Jack-Up Rig Stabilization - Leman Field
Jan 89	Odeco, USA	Jack-Up Production Rig Stabilization - Gulf of Mexico
Feb 89	Mobil	Jack-Up Rig Stabilization - Camelot Field
Feb 89	Mobil	Pipeline Stabilization - Camelot Field
Mar 89	Shell	Jack-Up Stabilization - Sole Pit

### Erosion Control Mat — Installations

Date	Client	Application / Location
Apr 89	Shell	Jack-Up Rig Stabilization - Leman Field
Apr 89	Amoco	Pipeline Free Span Correction - Indefatigable Field
Apr 89	Arco	Wellhead Protection Frame Stabilization - Welland
May 89	Shell	Jack-Up Rig Stabilization - Leman Field
May 89	Conoco	S. Valiant Field Development / Viking BC/BD Platforms
Jun 89	Odeco, USA	Jack-Up Production Rig Stabilization - Gulf of Mexico
Jun 89	Amoco	Pipeline Free Span Correction - Indefatigable Field
Jul 89	Arco	Wellhead Protection Frame Stabilization - Thames Oscar Field
Jul 89	Amoco	Pipeline Free Span Correction - Indefatigable Field
Aug 89	Shell	Jack-Up Rig Stabilization - Leman Field
Aug 89	Marenco Engineering	Power Cable Scour Correction - Prince Edward Island, Canada
Sep 89	Hamilton Bros.	Subsea Valve Stabilization - Ravenspurn North Field
Sep 89	Clough-Stena	SALM Riser Stabilization - Timor Sea, Challis Field, West Australia
Sep 89	Oceaneering / Amoco	Jack-Up Rig Stabilization - Penrod 85 - Leman Field
Oct 89	2W / Hamilton Bros.	Scour Prevention - Cleeton / Ravenspurn Fields
Nov 89	Shell	Jack-Up Rig Stabilization - Rowan Gorilla
Dec 89	Shell	Production Riser Stabilization - Leman Field
Feb 90	Shell	Jack-Up Rig Stabilization - Cecil Provine
Apr 90	Stena / Shell	Scour Prevention - Sole Pit Field
Apr 90	Stena / Amoco	Pipeline Span Correction & Stabilization - Indefatigable & Leman Fields
Apr 90	Conoco	Jacket Stabilization - Viking BC Platform
May 90	Shell	Jack-Up Rig Stabilization - Galveston Key
Jun 90	Phillips	Jacket Stabilization & Correction - Hewett Field
Jun 90	Rockwater / Arco	Umbilical / Pipeline Tie-Ins Stabilization - Welland
Jul 90	Stena / Amoco	Pipeline Stabilization - Indefatigable Field
Aug 90	Shell	Pipeline Free Span Correction & Stabilization - Leman Field
Sep 90	Stena / Amoco	Pipeline Stabilization - Indefatigable Field
Sep 90	Shell	Riser Stabilization - Leman Field
Sep 90	Rockwater / Shell	Valve Frame Stabilization & Protection - Sean Field
Sep 90	Stena / Amoco	Pipeline Span Correction & Stabilization - Indefatigable & Leman Fields
Oct 90	Stena / Amoco	Pipeline Stabilization - Indefatigable Field
Nov 90	Stena / Amoco	Pipeline Stabilization - Indefatigable Field
Dec 90	Christiani Morrison	Dornoch Bridge Scour Correction & Stabilization

## ENERGY ABSORBING REVETMENTS FOR BAYSHORE EROSION CONTROL

Donald R. McCreary\*

**ABSTRACT:** Many of Galveston Bay's shoreline problems can be solved by renovating the vertical existing structures with concrete sloping revetments. This idea can also be implemented so that all forms of erosion along low energy coasts can be stabilized using the Mac-Blox system, which is explained by description and application.

### INTRODUCTION

A unique system for shoreline stabilization is the Mac-Blox Sloping Revetment System developed in the Tampa Bay area of Florida. Since the fall of 1989 it has been successfully applied to shoreline problems common to the Galveston Bay area. It is a system of great strength, stability, and permanence. It has environmental features that are so favorable that it is considered as part of the environmental mitigation solution; rather than as part of the problem.

### DESCRIPTION

The Mac-Blox is made of concrete and weighs 300 pounds. They are placed to form a step-like sloping revetment; locked together with concrete shear piling in groups of ten or more. It is similar to rip-rap revetments, except it consists of large, specially designed concrete blocks, which have a number of significant advantages over rock structures. The Mac-Blox system is not used as surface armoring of flat slopes above the waterline. It is designed to work within the splash zone where wave energy crashes into shorelines and destroys most other structures. A single Mac-Blox is shown in Figure 1. The basic features of the Mac-Blox is as follows:

---

\* President, Mac-Blox Corporation, 1444 20th Street North, St. Petersburg, Florida 33713

Figure 1

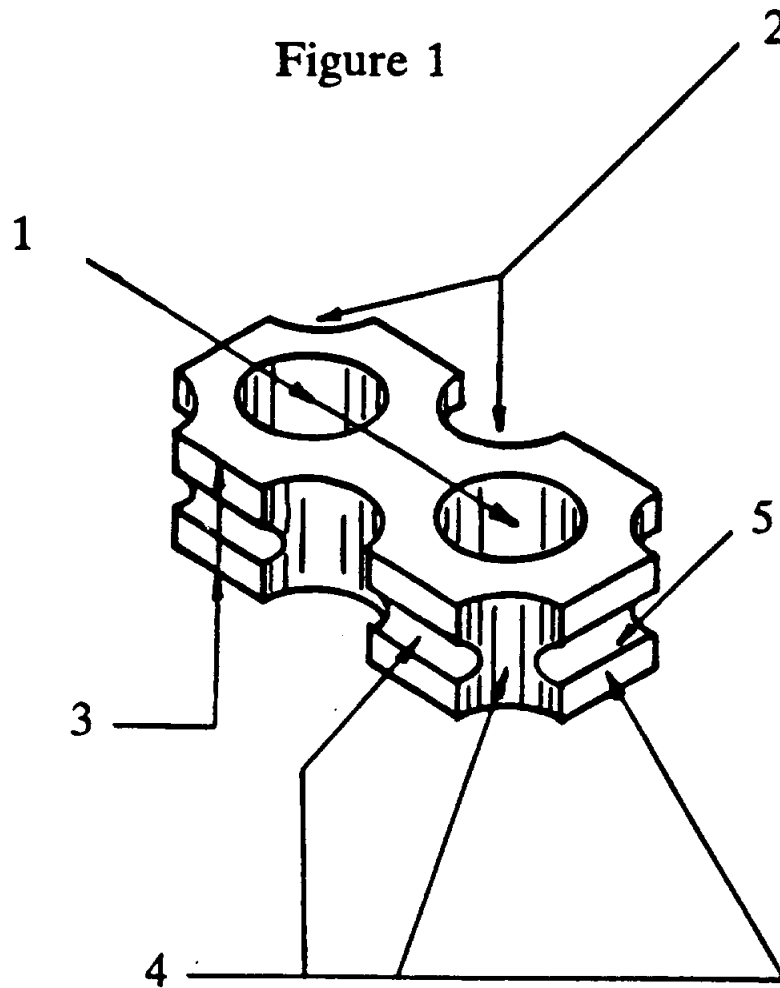

1. **CYLINDRICAL SPACES:** Vertical cylindrical spaces in the center of each block match successive layers and are used for shear piling which lock the layers together.
2. **PERIMETER SHAPE:** The perimeter shape of each block match with adjacent units to create internal spaces for 1) animal habitat, 2) protected growing space for marine plants, and 3) hydraulic surge space for absorbing wave energy. The Mac-Blox has the same amount of internal spaces as natural stone revetments.
3. **FLAT SURFACES:** Flat surfaces top and bottom provide cost-effective production and safe surfaces for walking on the finished revetment.
4. **MULTI-FACETED:** The multi-faceted, rough, sloping surface is presented to wave energy approaching from any angle for optimum energy absorption.
5. **HORIZONTAL GROOVES:** Horizontal grooves are used for communication between vertical cylindrical spaces.

This modular system results in ideal 2H : 1V sloping revetment with rough surfaces and internal spaces to absorb wave energy, and prevent erosion of bottom material.

## **BASIC PRINCIPLES OF SHORELINE STABILIZATION**

In recent years, the ideal shoreline structure for absorbing wave energy has been defined as having three important characteristics.

1. **SLOPING** - so waves do not slam, rebound, and cause erosion.
2. **ROUGHNESS** - to impede and diffuse wave runup/rundown.
3. **SPACES** - internal to absorb and cushion wave energy while providing habitat for marine plants and animals.

Mac-Blox has incorporated all three characteristics into its basic design. Other, equally important design characteristics were drawn directly from the technology of rock structures that have proven themselves in countless applications:

1. **DENSITY** - mass of concrete is very close to rock.
2. **RATIO OF SPACES** - solid mass to spaces approx. 80/20.
3. **SLOPE RATIO** - 2 horiz/1 vertical for geometric stability.

## **EXISTING TECHNOLOGY**

By far the most common attempt to stabilize shorelines in shallow coastal areas has been the use of vertical seawalls; usually of steel reinforced concrete. The Tampa Bay area of Florida is one of the most heavily seawalled areas in the world. Unfortunately these vertical seawalls violate most of the desirable parameters listed. In addition, the uncoated steel reinforcement that was used in most of these walls is a prescription for failure because of the corrosive environment of the salt water splash zone. These failures are now occurring at an alarming rate. The basic premise of Mac-Blox is that it doesn't make sense to temporarily patch these up. The basic problem of the structure's verticality will only perpetuate. These existing structures should be converted to a permanent sloping revetment and Mac-Blox is the optimum system that should be incorporated. Figures 2 & 3 show a Mac-Blox system used to prevent failure of a vertical seawall at Pinellas Bayway-St. Petersburg, Florida.

## **MAC-BLOX FEATURES**

**IMPROVEMENTS** - The Mac-Blox system began with all of the well proven physical characteristics of rock structures, and added modern materials, structural integrity, great logistical advantages, cleaner appearance, user safety, and even better environmental qualities.

ISLA KEY CONDOMINIUM - PINELLAS BAYWAY - ST. PETERSBURG, FLORIDA

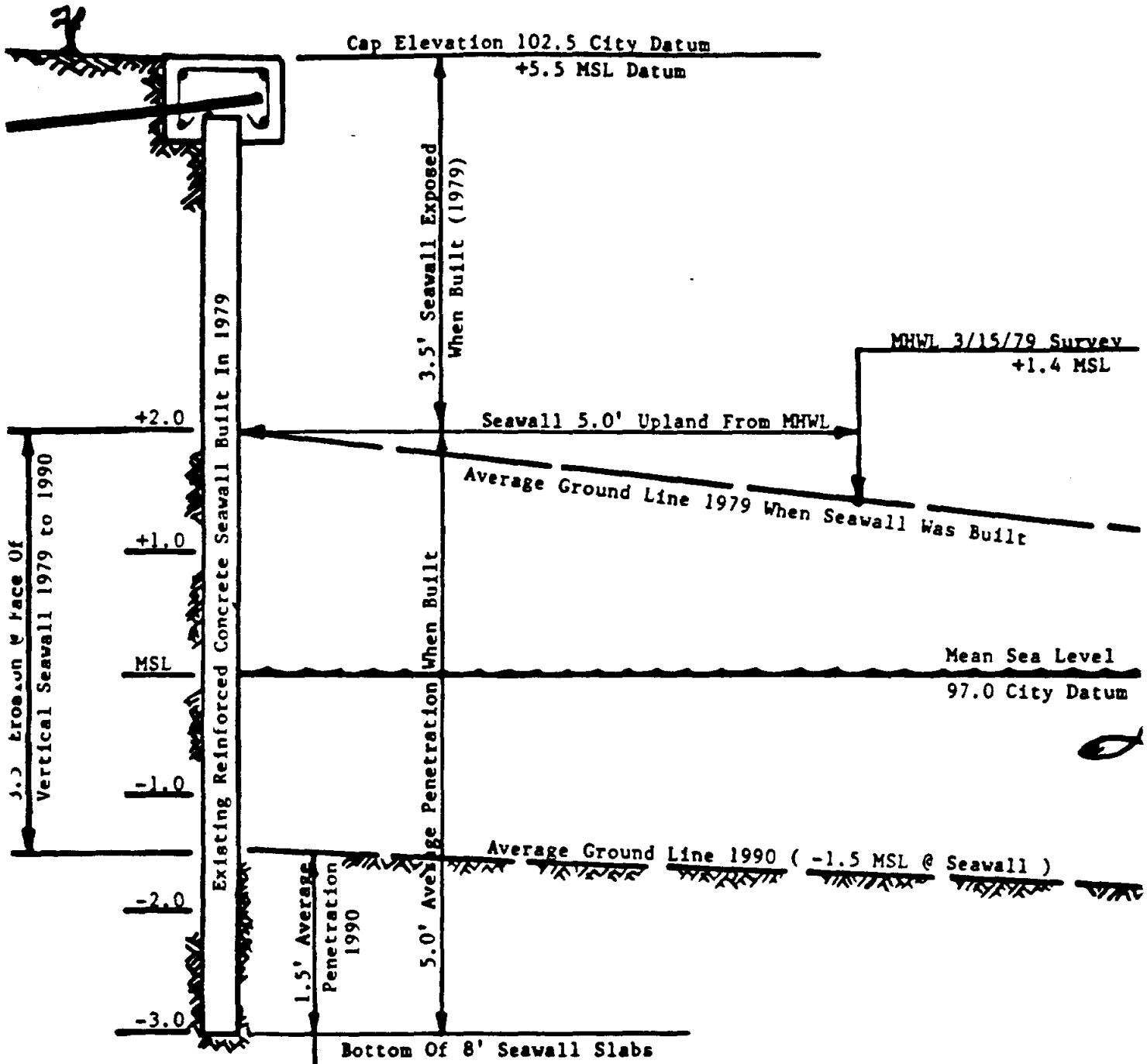

City Standards Require 40% Of Seawall Height = 3.4' Minimum Tieback System, Slab Reinforcement, And Other Structural Elements Also Designed For 3.4' Minimum Penetration.

SEAWALL SYSTEM HAS BECOME SEVERELY OVERSTRESSED DUE TO EROSION OF THE GROUND AT THE FACE OF THE VERTICAL SEAWALL. EROSION IS LIKELY TO CONTINUE AND FAILURE COULD OCCUR AT ANY TIME.

Figure 2  
104



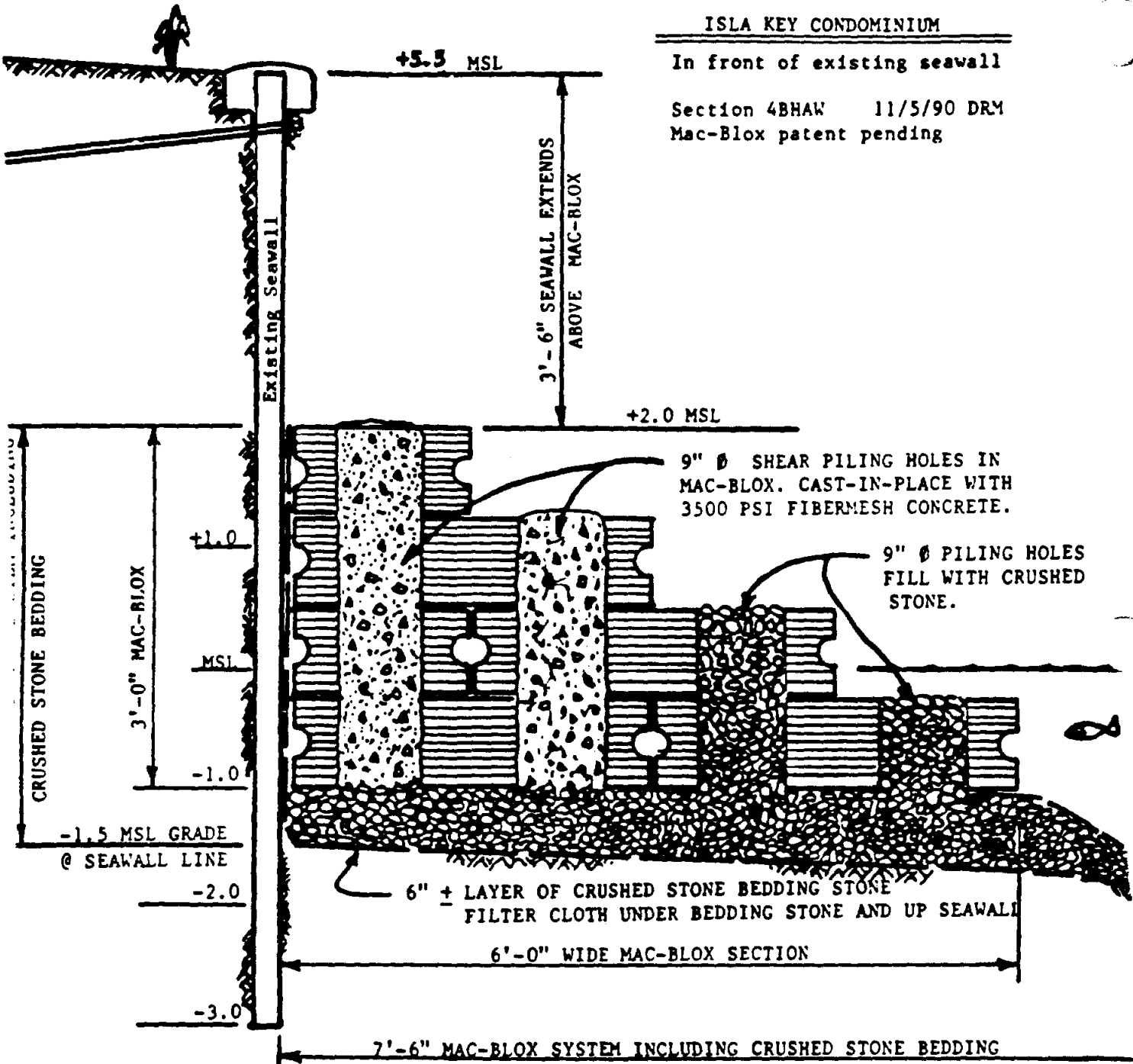

MAC-BLOX SLOPING REVETMENT WILL PREVENT FUTURE EROSION AND PROVIDE PERMANENT STRUCTURAL SUPPORT FOR SEAWALL.

Figure 3  
105

**ENVIRONMENTAL** - Mangroves, spartina, and similar plants, as well as many forms of small marine animals, thrive within the protection of the carefully designed internal spaces of the Mac-Blox system. These were carefully developed, with input from regulatory and environmental agencies, to have all the desirable physical characteristics of rip-rap, and to improve upon rip-rap in all of these areas.

**REGULATORY REQUIREMENTS** - From the beginning the Mac-Blox system was developed to be fully in compliance with both the requirements and preferences of knowledgeable regulatory agencies and environmental consultants. Many of these characteristics came directly from Florida DER. The overall solid mass vs interior space ratio, is the same as DER, and Corps of Engineers approved rip-rap rock structures. The Mac-Blox system presents a very rough sloping surface to approaching waves, and this together with the carefully designed interconnecting interior spaces dissipates wave energy in a way that is superior even to the rip-rap rock.

**MODULAR CONCEPT** - The Mac-Blox system is a modular concept. From the beginning a scaling factor was envisioned for block sizes for different applications. These parameters are related to the wave energy environment and can be scaled for use almost anywhere.

**STRUCTURAL INTEGRITY** - By far the most important factor for anyone considering a shoreline stabilization system, is structural integrity and long range security. The Mac-Blox system is designed on the same simple, dependable, low stress structural principles that have been developed and proven on an empirical basis with the rip-rap rock. The Mac-Blox are built entirely using modern Fibermesh Concrete. There is no steel to rust, expand, and crack the concrete. In addition, the cast in place shear piling provides quality controlled structural integrity that is superior to the random interlocking of rip-rap rock.

**AESTHETICS AND SAFETY** - Mac-Blox has a significant advantage in attractiveness and safety over rip-rap rock. The flat steplike surfaces make easy walkways. The attractive mosaic appearance is a dramatic improvement over rough irregular rip-rap.

**COST EFFECTIVENESS** - In order for an idea to be successful in the competitive marketplace, it must be designed for efficient manufacture and installation. The final result must compare favorably with alternative solutions and give good value for every dollar spent. When considering the advantages of using Mac-Blox over rip-rap revetments no questions should be raised about the cost effectiveness of Mac-Blox.

## **CONCLUSION**

Mac-Blox is proving to be an environmentally responsible solution to many of our shoreline problems in Tampa Bay and other areas of Florida. Many of the same problems exist in Galveston Bay, and there is belief that the system would be of tremendous value. Located in the appendix are various examples of Mac-Blox used in different situations in Florida. These examples will give a good basic idea to the workability of implementing a system in the Galveston Bay area.

## **APPENDIX**

### **LIST OF FIGURES:**

- Mac-Blox Dimensions
- Mac-Blox Jetty/Groin Sections
- Mac-Blox Rip-Rap System Plan
- Mac-Blox Rip-Rap System Section
- New Mac-Blox Seawall System
- Mac-Blox Sloping Revetment Wall #1
- Mac-Blox Sloping Revetment Wall #2
- Mac-Blox Sloping Revetment Wall #3

## **ACKNOWLEDGEMENTS**

I would be happy to make the Mac-Blox system available to the Galveston area, and work with those who are interested in specific applications or more information on the system. I would like to express my thanks to Dr. Wang for the opportunity to present Mac-Blox to you.

Donald R. McCreary, President  
MAC-BLOX CORPORATION  
1444 20th Street North  
St. Petersburg, FL 33713



# MAC-BLOX JETTY/GROIN SECTIONS

INTERCONNECTING INTERIOR SPACES (VERTICAL AND HORIZONTAL)  
FOR DISSIPATING WAVE ENERGY AND PROVIDING HABITAT  
FOR MARINE LIFE

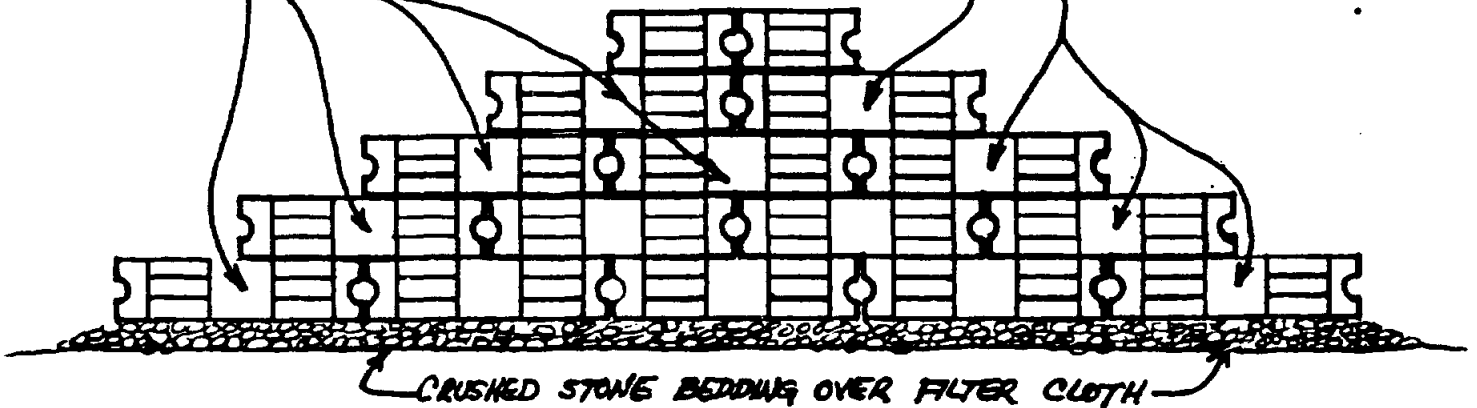

TYPICAL CROSS SECTION AT PERIMETER OF MAC-BLOX

SHEAR PILING HOLES FILLED WITH CRUSHED STONE

SHEAR PILING HOLES IN MAC-BLOX  
CAST IN PLACE WITH  
FIBERMESH CONCRETE

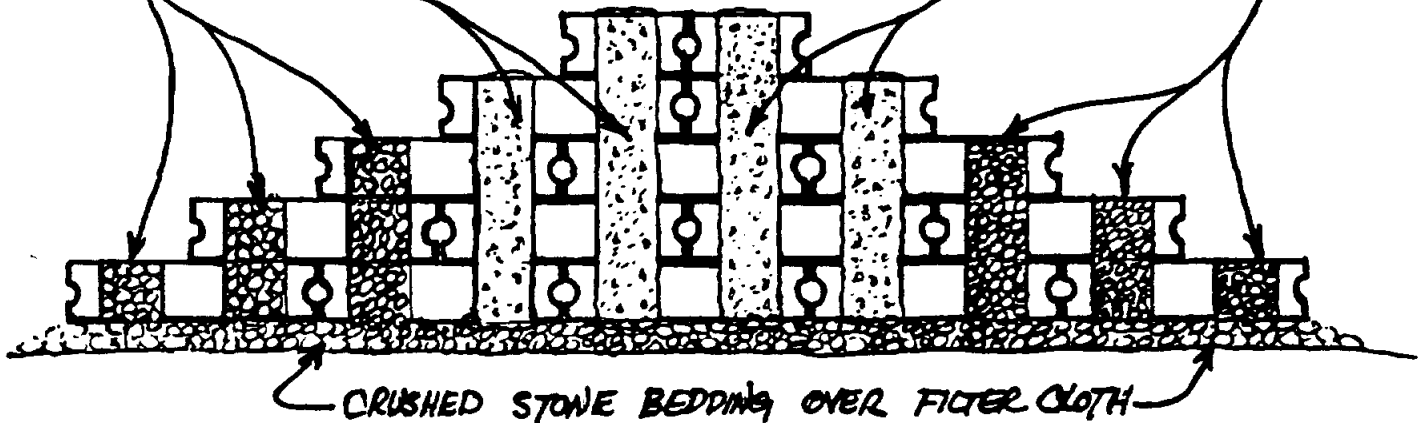

TYPICAL CROSS SECTION AT CENTER OF MAC-BLOX

MAC-BLOX  
(PATENT PENDING)  
3/9/90 DRM  
SBHJK

# MAC-BLOX RIP RAP SYSTEM PLAN

17900-17964 U S HIGHWAY NORTH  
CLEARWATER, FLORIDA

RAISE EXISTING CURB 6'  
FOR 10' ON EACH SIDE  
OF RIP RAP TO CONTROL  
RUN OFF

EXISTING ASPHALT  
PARKING LOT

4' THICK CONCRETE  
INFILL BETWEEN EXISTING  
CURB AND MAC BLOX

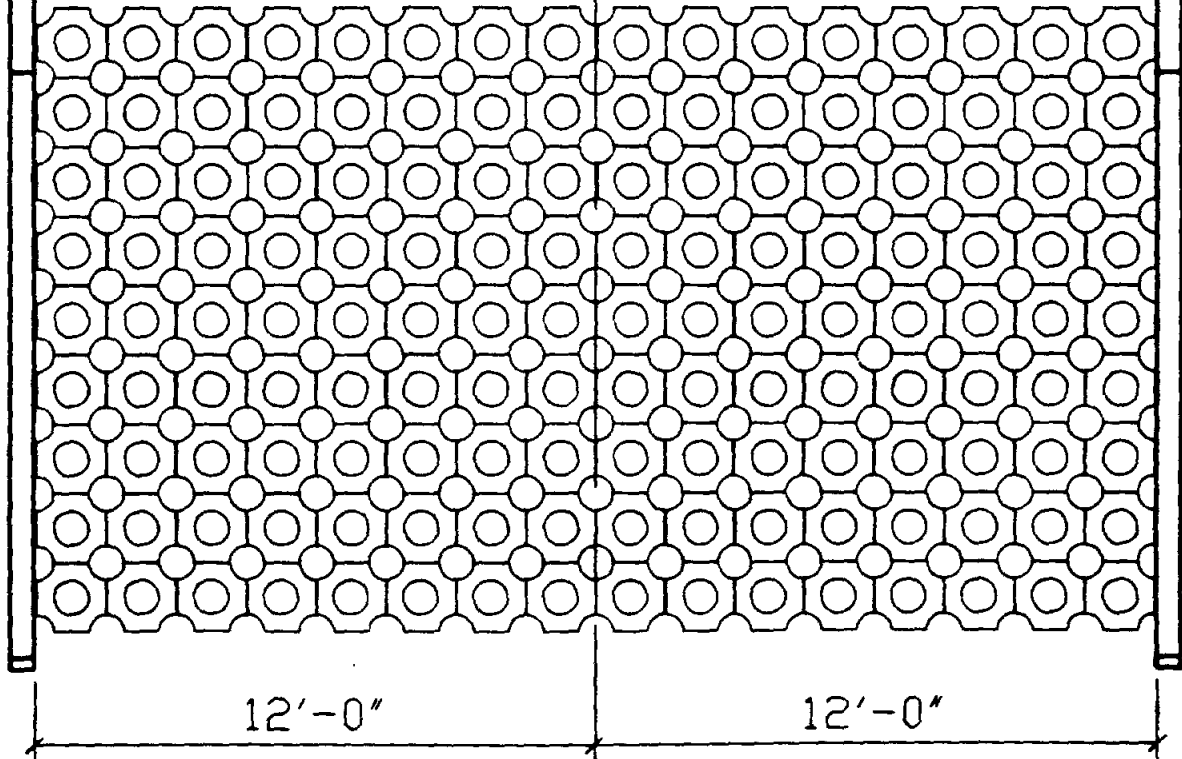

# MAC-BLOX RIP RAP SYSTEM SECTION

17900-17964 U S HIGHWAY NORTH  
CLEARWATER, FLORIDA

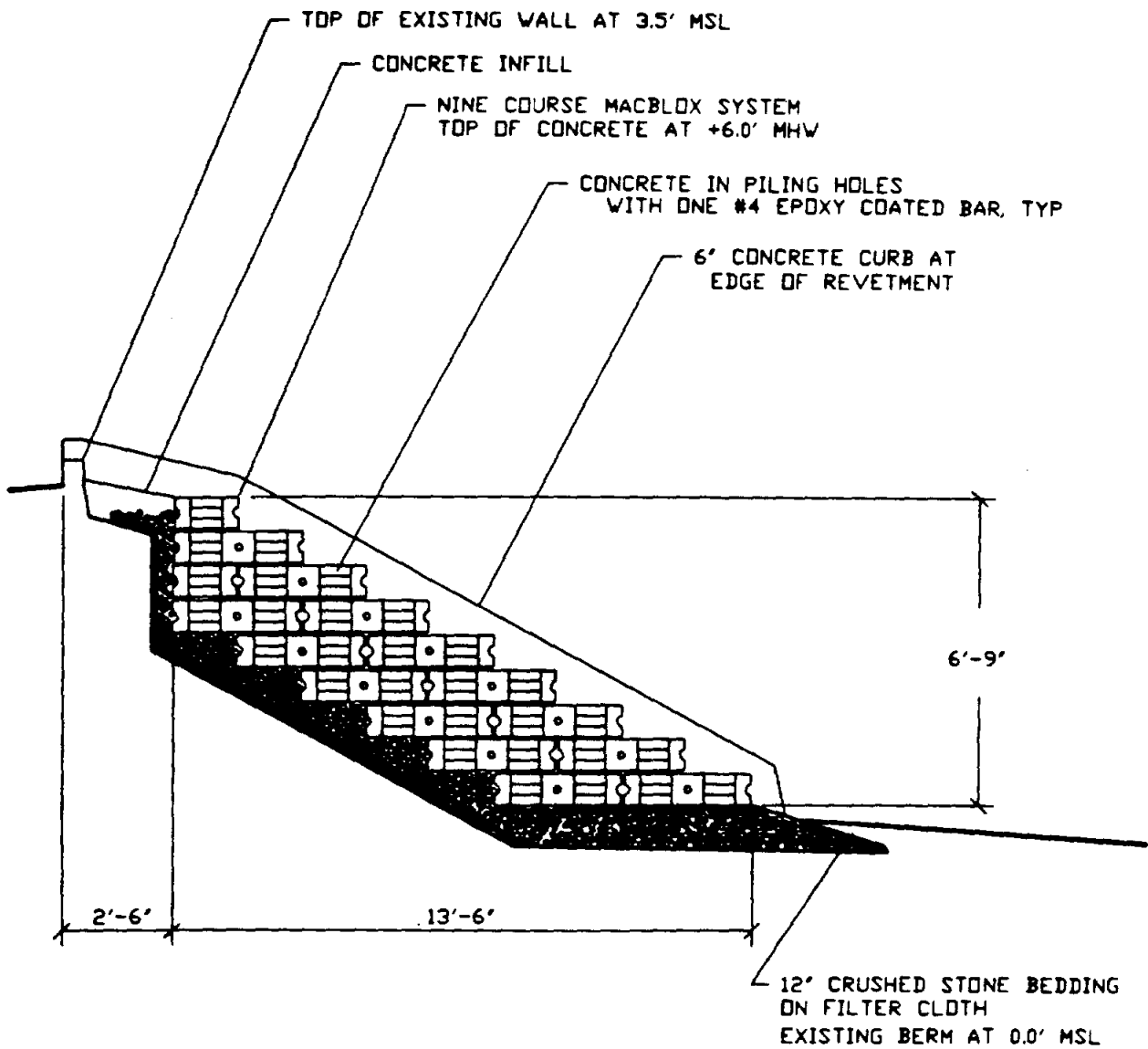

NEW MAC-BLOX SEAWALL SYSTEM  
 (SLOPING REVETMENT BUILT-IN)  
 COMPOSITE SECTION 5BHICW  
 MAC-BLOX CORP. 9/17/91 DRM

PROPOSED FOR THE CITY OF WEST PALM BEACH  
 NORTH FLAGLER DRIVE AT CURREY PARK

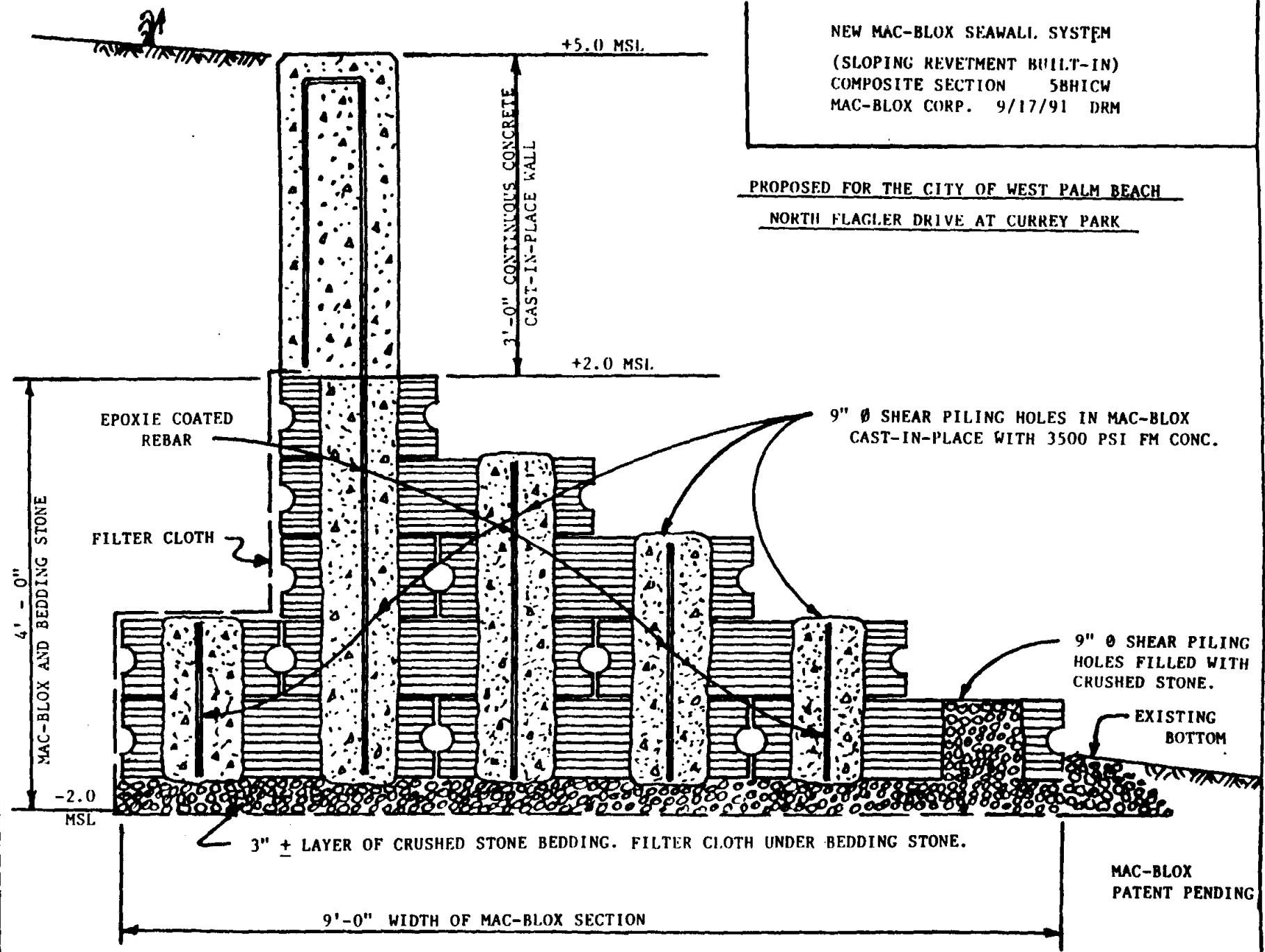

EPOXIE COATED REBAR

FILTER CLOTH

9" Ø SHEAR PILING HOLES IN MAC-BLOX  
 CAST-IN-PLACE WITH 3500 PSI FM CONC.

9" Ø SHEAR PILING HOLES FILLED WITH  
 CRUSHED STONE.

EXISTING  
 BOTTOM

3" ± LAYER OF CRUSHED STONE BEDDING. FILTER CLOTH UNDER BEDDING STONE.

MAC-BLOX  
 PATENT PENDING

9'-0" WIDTH OF MAC-BLOX SECTION

MAC-BLOX AND BEDDING STONE  
 4' - 0"

+5.0 MSL

+2.0 MSL

-2.0  
 MSL

3'-0" CONTINUOUS CONCRETE  
 CAST-IN-PLACE WALL



MAC-BLOX SLOPING REVETMENT RETAINING WALL

PROPOSED FOR BEN T. DAVIS PARK - TAMPA, FLORIDA PARKS DEPARTMENT

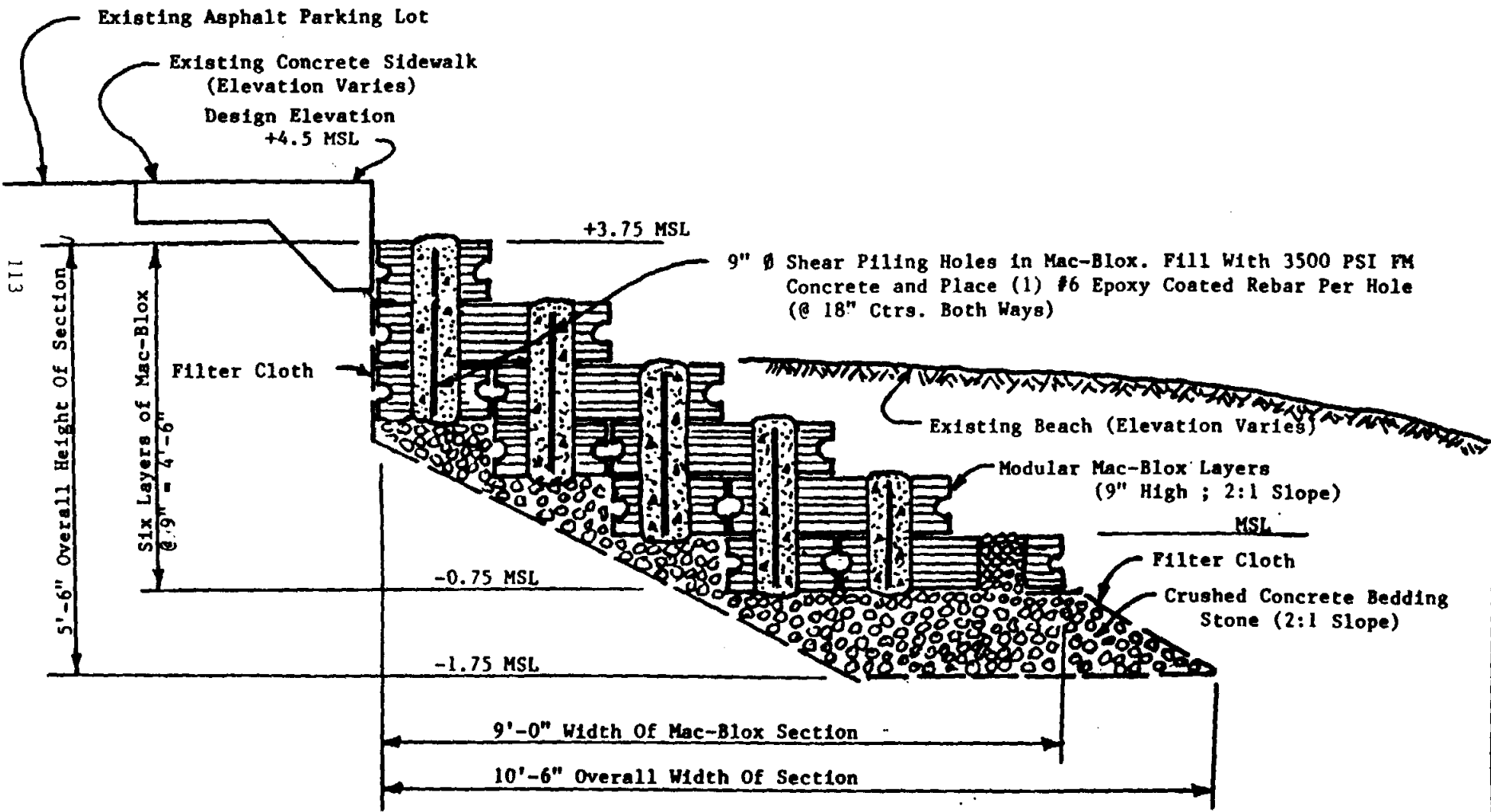

**MAC-BLOX SLOPING REVETMENT RETAINING WALL**

**PROPOSED FOR SILVER SANDS CONDOMINIUM - ST. PETERSBURG BEACH, FLA.**

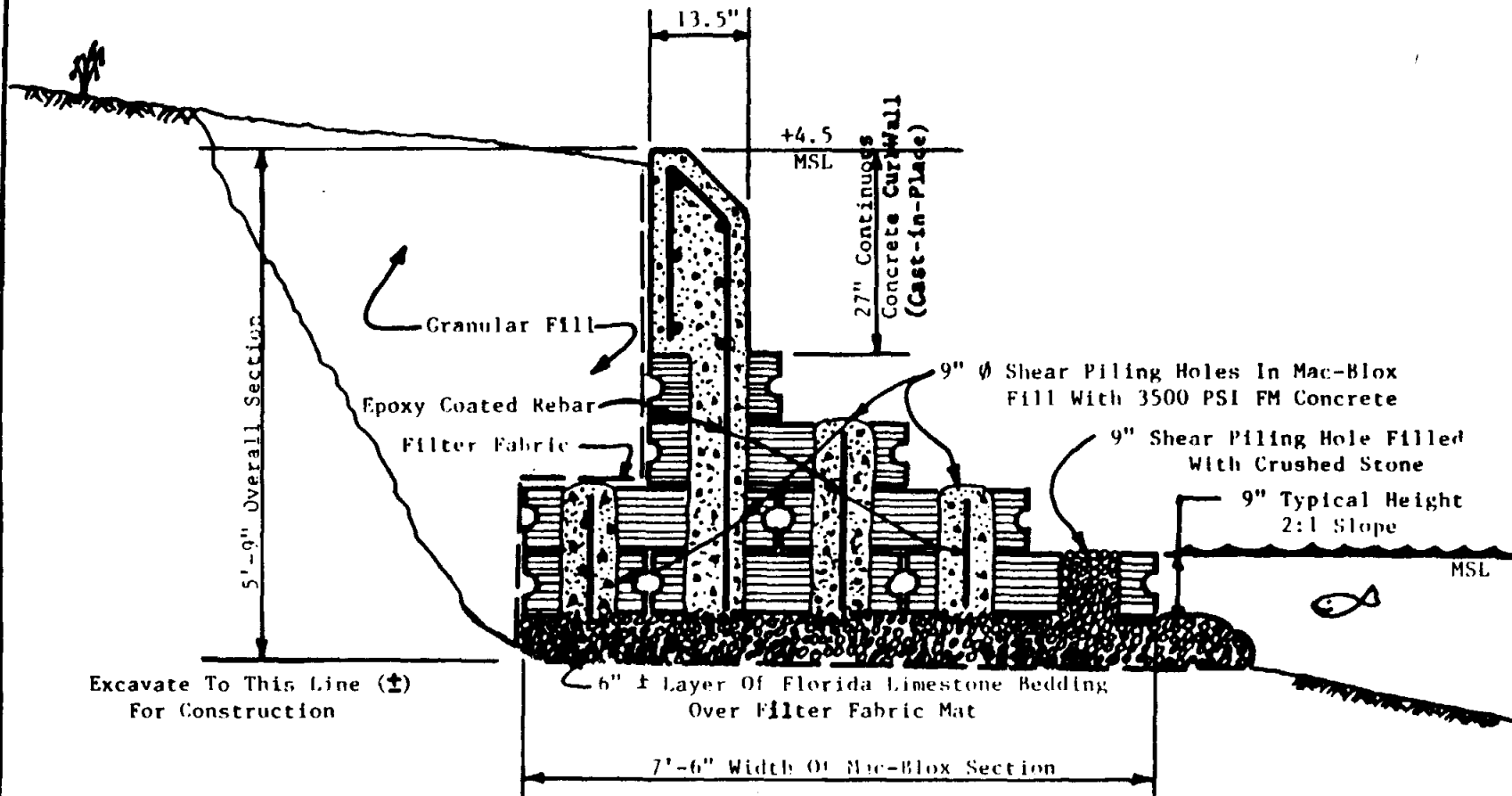

711

Mac-Blox Patent Pending

**MAC-BLOX CORPORATION**

Standard Section

4BH27CW

3/21/91

DRM

**MAC-BLOX SLOPING REVETMENT RETAINING WALL**  
**PROPOSED FOR ST. PETERSBURG BEACH EGAN PARK**

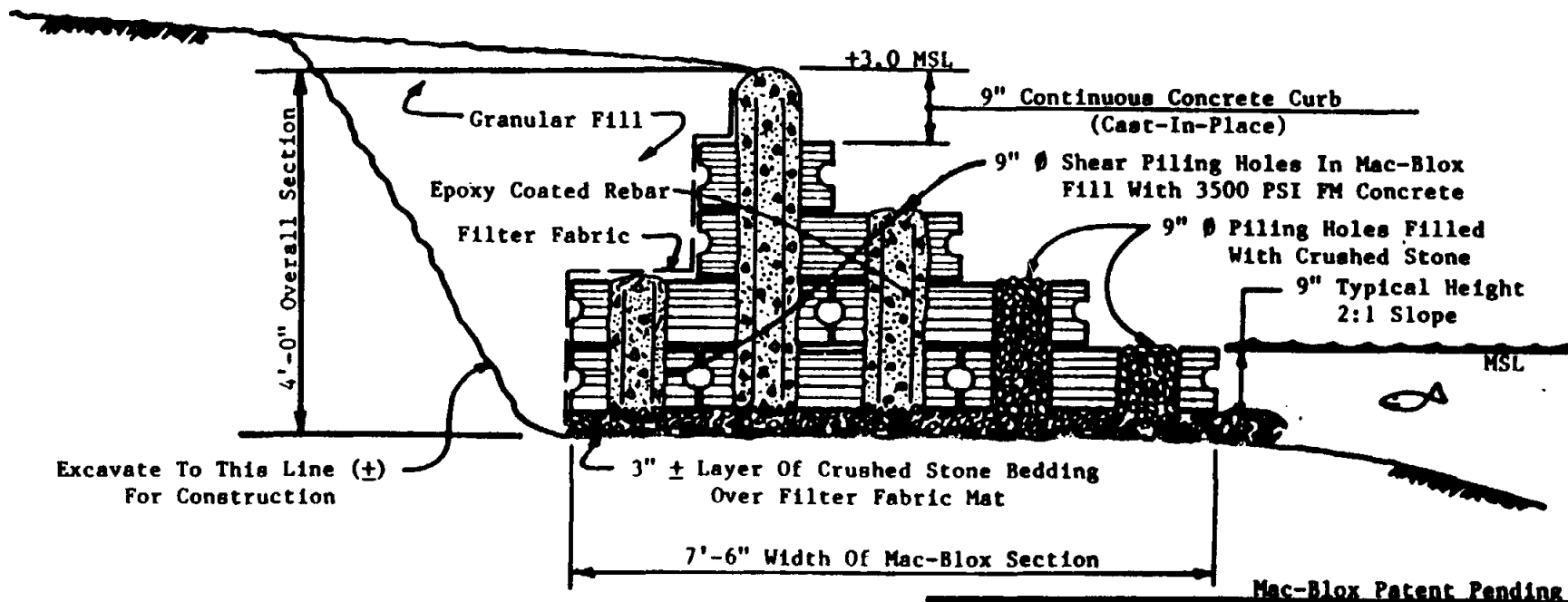

<b>MAC-BLOX CORPORATION</b>	
Standard Section	4BHICRB
7/3/90	DRM

115

**JETPUMP APPLICATION FOR BEACH  
REPLENISHMENT AT BIG REEF  
GALVESTON, TEXAS**

**M.McMahon<sup>1</sup> & B.Gates<sup>2</sup>**

**ABSTRACT:** This proposal is a design to increase the recreational beach area at Galveston's groin field. A permanent pumping station is installed utilizing the closest renewable sand source for nourishment material. Moveable jet pumps are considered for their use underwater to optimize the best efficiency in removing the sand.

**INTRODUCTION**

There is a growing economical need for more recreational beach area on Galveston Island. The only efficient way to increase the beach is by nourishment. With a large area of accumulated sand located closeby, there is a possibility of dredging and pumping the sand to directly to Galveston beaches.

**PHYSICAL ENVIRONMENT**

In 1934 the Beach Erosion Board, Corps of Engineers, found that in order to protect the Seawall and recreational beach a system of groins needed to be constructed. The board also concluded that there was a possibility that the groin system would not be nourished by natural action and that other means of beach nourishment might become necessary. The original purpose of the groin field has functioned as intended by stopping erosion at the seawall. The shoreline is considered essentially stable at the groin field, however beach

---

<sup>1</sup> Senior Engineering Student, Texas A&M University at Galveston.

<sup>2</sup> Senior Engineering Student, Texas A&M University at Galveston.

nourishment in this area would be susceptible to erosion. The erosion would be caused by shortening the effective length of the groins, therefore increasing the new beach materials exposure to wave forces and longshore transport. Down drift beaches would then benefit from the eroded material of the groins. One reason that the beaches are not nourished naturally is because of the construction of the Galveston entrance jetties. Jetty construction (1880's) disrupted the ebb tidal delta. Any net westward transport has apparently been stopped by the jetties at the Galveston entrance causing the beaches on the island to starve. The inlet does, however, receive longshore sediment transport from both the north and south directions. One possible source of sand for nourishment is the massive deposits at the south fillet (Big Reef) along the north side of the south jetty.

A sediment budget was done on Galveston Island of approximately 54,000 feet from the South Jetty to Scholes airfield. This area is backed by the seawall for its entire length. Small amounts of sand may pass over the seawall from the sand being blown, but the majority will accumulate at the base. The eolian transport potential is assumed to be 1 cy/ft of beach front due to the presence of the seawall. Sand blown across the South Jetty into the Galveston Channel is also considered. A measurement of 335,000 cubic yards per year is calculated within this reach. Approximately 59,000 cubic yards is assumed to be transported shoreward from the south jetty from the disposal area.

## OPTIONS TO THE PROBLEM

Sediment could be dredged from offshore and deposited on the beaches of Galveston, although this may not be cost effective. A dredge cannot normally operate year round or in all wave conditions. This would mean that beaches would get nourished only when the dredge was able to operate. Also the dredge would be on standby if the beaches should only need periodic nourishment. A solution to these problems is construction of a permanent pumping station. The pumping station, by using jet pumps, could operate in virtually any wave climate or time of year. The pump station could also have the capabilities of moving the pumps around to find the best sediment deposits.

## SOLUTION

The method of sand bypassing using submersible jet pumps would consist of a pumphouse housing a clear water pump and a booster pump. The clear water pump would draw water into the station through a suction line and force it out through an injection line to feed the jet pumps. The jet pumps create a sand/water slurry that would be fed back into the pumphouse through a discharge line. The slurry would then be discharged to a spoil area through booster pumps.

The single jet pump consist of a pipe section containing a nozzle, 2 suction inlets, a mixture chamber, diffuser, and a discharge outlet. A clearwater pump forces water through the nozzle. The high velocity fluid is forced into a mixing chamber and through the diffuser where some pressure energy is recovered as the velocity slows. This induced flow at the

suction opening is created by negative pressure produced in the diffuser. When the suction opening is connected to a pipe that is buried in the sand the slurry is drawn into the pump. The use of a conventional dredge pump or booster pump downstream of the jet pump helps move the material through the pipeline.

The two jet pumps should be able to pump a combined total of 150 cubic yards per hour as a minimum. The water supplied needed for operation equates to 450 gallons per minute for each pump, a total of over 900 gpm. The water supply line should be a 8.795 ID polyethylene pipe to reduce frictional head. The slurry discharge pipe should be of adequate size in order to keep the solids in suspension. The booster pumps should maintain a minimum velocity of 9 feet per second. A total of 16 booster pumps are needed spaced approximately 2300 feet apart.

The pumphouse would be located at 94 degrees 43.65' longitude and 29 degrees 20' latitude, approximately 600 feet north of the South Jetty and 150 feet south of the Big Reef. The jet pumps are attached by flexible hoses for moveability. The length of jet discharge to the booster pump is around 400 feet.

## CONCLUSION

The nourished beach would rise on a 1 to 30 slope from mean low water to an elevation of +4.0 with 170 feet of recreational beach area. From the mean low water point new material will extend down to a 1 to 50 slope. With 2 million cubic yards of material needed to nourish the existing groin field total nourishment should take close to 4 years. The estimated costs are as follows:

### Beach Nourishment Cost Estimate (Preliminary)

Description	Unit/Quantity	\$ Cost
Pumping Equipment		\$ 500,000
Pipe	\$7.39/linear ft	\$ 300,000
Structures	17 @ 200 sq.ft ea.	\$ 140,000
Computer equipment	17	\$ 750,000
Contingencies	(15%)	\$ 138,000
Eng. & Design	(7%)	\$ 64,400
Administration	(8%)	\$ 73,600
Interest (Construction)	(7.5%)	\$ 70,000
	Approx. Total	<u>\$2,050,000</u>

## REFERENCES

1. Galveston County Shore Erosion Study - Feasibility Report & Environmental Impact Statement, U.S.C.O.E., (May, 1985).
2. Hydraulics of Stability of 5 Texas Inlets, Curtis Mason, (Jan, 1981).
3. U.S. Army Corps of Engineers, Sand Bypassing System Selection, EM 110-2-1616, Washington, D.C., (Jan,1991).
4. Wang Y.H., Preliminary Designs of Improvements at Rollover Pass and Vicinity, Texas A&M University at Galveston, Department of Maritime Systems Engineering, (Dec,1989).

**HORIZONTAL DEWATERING SYSTEM  
FOR  
SHORELINE STABILIZATION**

**Donald R. Justice\***

**ABSTRACT:** A beach preservation system is implemented using underground dewatering. The main idea behind the system is that incoming water waves are drained through the beachface, leaving sand accumulations. This system can lengthen project life of nourishment projects and ultimately preserve the sand on beaches.

---

\* President, Horizontal Wells, A Division of H.D.S.I., P.O.Box 150820, Cape Coral, Florida 33915



## Horizontal Dewatering Systems, Inc.

---

Horizontal Dewatering Systems, Inc. (HDSI) is a Florida corporation organized in May of 1987. Though still a young company, HDSI's founder, Donald R. Justice, has more than 30 years of proven success in the underground construction industry.

HDSI's initial efforts were directed at developing a cost effective dewatering system for that industry. However, those initial efforts soon evolved into a new technology that replaces the traditional, vertical wellpoint dewatering systems that have dominated the construction industry for decades.

This new technology, called the Horizontal Well, is currently extracting non-potable, surficial aquifer ground waters from depths up to 20 feet. In less than 12 months, improved equipment designs will allow HDSI to work at depths of 25 feet. However, HDSI has already proven not only to be superior to the traditional vertical wellpoint systems, but exceptionally time and cost-effective as well.

During the early installation and development work, it soon became evident to HDSI's senior management that the application of the Horizontal Well extraction and recovery concept possessed additional advantages when applied to other water resource recovery, reuse and environmental enhancement endeavors, inclusive beach stabilization.

While continuing basic construction dewatering efforts, HDSI became convinced that the increasing value of water rights and declining sources of potable water made surficial recoveries even more important. That increased value is due in part to the natural hydrological cycle of water resources but more so by the need of states, cities and municipal authorities to access and use water in an environmentally responsible manner. Industrial and commercial enterprises have also created the need for site containment barriers, water cleanup and recharge and reuse.

In fact, waste water effluent discharge into natural surface water bodies is the subject of much state and federal legislation, regulation and policy, and the water reuse concept has been accepted - and in some cases, mandated - as a method of protecting and prolonging precious water resources.

To that end, Horizontal Wells have been installed as irrigation supply wells for agricultural operations like citrus groves and ferneries and even non-agricultural entities such as golf courses. HDSI has also used its system in cleanup efforts on contaminated sites - both for water and contaminate extraction - and for aquifer recharge using treated and/or processed water.

cont'd.

---

---

To date, HDSI has completed over 1,000 installations, utilizing nearly 300 miles of Horizontal Wells systems. This proven technology has been successfully used on both long and short term projects. Along the way, the company has developed many refinements in the system's capability and performance including better trenching production, extremely durable piping and filter materials, all adding to the overall performance of HDSI's highly skilled personnel. HDSI's acceptance in the marketplace is growing rapidly and serves to underscore the system's uniqueness as its major asset.

## **How Does HDSI's Beach Preservation System Work?**

---

If the water table at a beach face is higher than sea level, water tends to run out of the beach face, carrying sand with it, into the retreating waves.

However, if the water table at the beach face is artificially lowered below sea level, incoming waves drain into the beach face holding the sand in place, thus preserving the shoreline.

That is, each incoming wave is composed of a mass of water moving above some mean water level. The greater the mass of water in the incoming wave, the more solid material transport capacity is created. The hydrostatic pressure of these incoming waves breaks up the beach face by forcing apart its grains of sand and, when combined with the outflow of water from the beach face - and the turbulence of the breaking wave - suspends the sand in the retreating wave and results in the subsequent loss of beach material.

If the hydrostatic pressure within the beach face could be locally reduced, the inflow of water from waves into the beach face would result in an adhesion between the grains of sand on the beach. If the reduction in hydrostatic pressure is substantial enough, the beach face becomes resistant to material suspension, transport by wave action, and the result is a significant reduction in beach face erosion.

By removing water from the beach face, HDSI's proprietary system controls the hydrostatic pressure, providing the desired result. Its groundwater recovery and control system has been used extensively for years across a wide array of applications. Specialized patented equipment provides rapid, economic installation, while specialized operations and monitoring systems have been developed and are in use on the newest systems. The cost effective package of equipment, material and know-how can now be deployed in beach preservation.

Horizontal Wells can substantially prolong the life of beach fill and renourishment projects by keeping the material in place longer and can reduce recurring renourishment programs, costly to taxpayers, owners and others involved in beach preservation.

## **Advantages of HDSI's Beach Preservation System**

---

- Can be installed in a fraction of the time required for conventional sand drain dewatering systems.
- More cost effective than conventional systems.
- Dramatically less destructive than conventional systems and once completed, returns the beach front to its natural state.
- Environmentally friendly, even to sensitive turtle habitats.
- System components are long lived, even in hostile salt water environments.
- There are no hard structures to disrupt natural shore life.
- Depth of installation precludes storm damage.
- The system can be operated at variable rates, both automatically and manually. Once the shoreline is normalized, the system will function in a maintenance mode.
- Costly recurring beach renourishment cycles are minimized.



## **Quotes on Benefits & Advantages of the System**

---

---

"The benefits of this proprietary system are multi-fold:

- There are no physical above-ground or in-water impediments. This system, when installed and operating, offers no obstructions to walkers, strollers, swimmers or recreational use on the beach.
- It offers no impediments to any animals, fish, birds or organisms that live in the beach. The exposed features are virtually unnoticeable and are located on uplands designed to have no influence on any swimming organism. There are no structures to interfere with the swimming or feeding actions of fish or birds.
- It is invisible. The beauty, aesthetics and function of the beach remains the same.
- The system can be operated either manually or automatically. The function can be varied with natural changes in sediment transport rate, wave conditions, or seasonal requirements or can be adjusted to reduce the subsurface hydrostatic field on timing operational cycles.
- The system can be operated at variable rates. Thus, sands can be induced to collect and the system can be operated allowing the shoreline to normalize. Once the shoreline is normalized, the system will function in a maintenance mode.

Geo-Marine, Inc.  
Dr. Michael Stephen, Ph.D, P.G.

## **Quotes on the Efficiency of the System**

---

---

"Changes in ocean still-water level and beach ground water level are the most important variables influencing changes in foreshore sand volume." Coastal Zone Conference, 1989.

"This process can substantially prolong the residence time of beach fill material, extend project life and reduce the overall cost to the taxpayer." Dr. Michael Stephen, Ph.D., P.G., Geo-Marine, Inc.

Commenting on the actual installation of a beach face dewatering system, Dr. Robert G. Dean of the University of Florida stated: "The [beach] segment within the system...has experienced a gradual increase and has been relatively stable compared to the adjacent segments..."

# PROPOSED HORIZONTAL WELL BEACH PRESERVATION SYSTEM

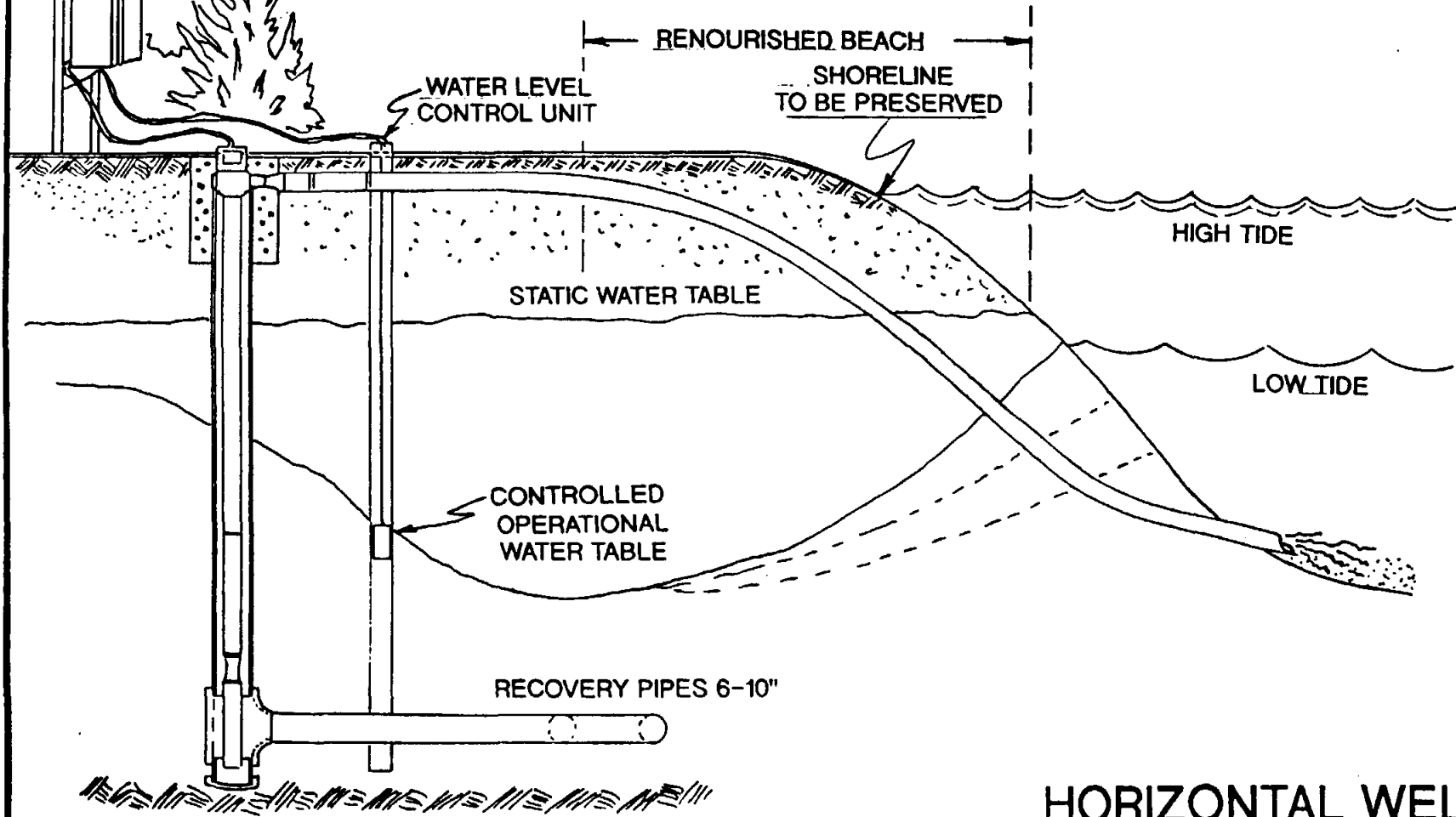

126

**HORIZONTAL WELLS**  
A DIVISION OF **H.D.S.I.**

P.O. BOX 150820 CAPE CORAL, FL 33915

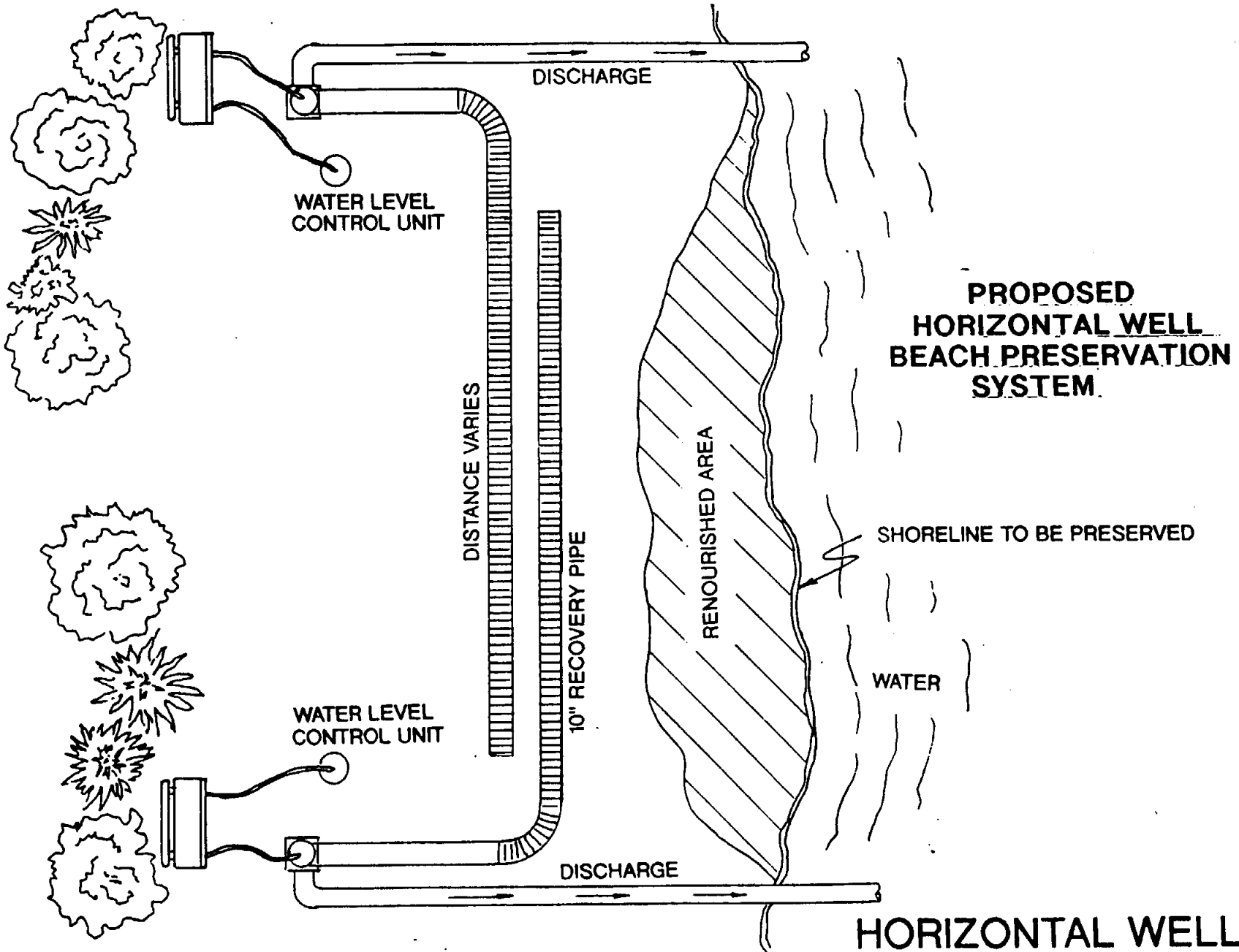

**PROPOSED  
HORIZONTAL WELL  
BEACH PRESERVATION  
SYSTEM.**

SHORELINE TO BE PRESERVED

WATER

**HORIZONTAL WELLS**

A DIVISION OF **H.D.S.I.**

P.O. BOX 150820 CAPE CORAL, FL. 33917

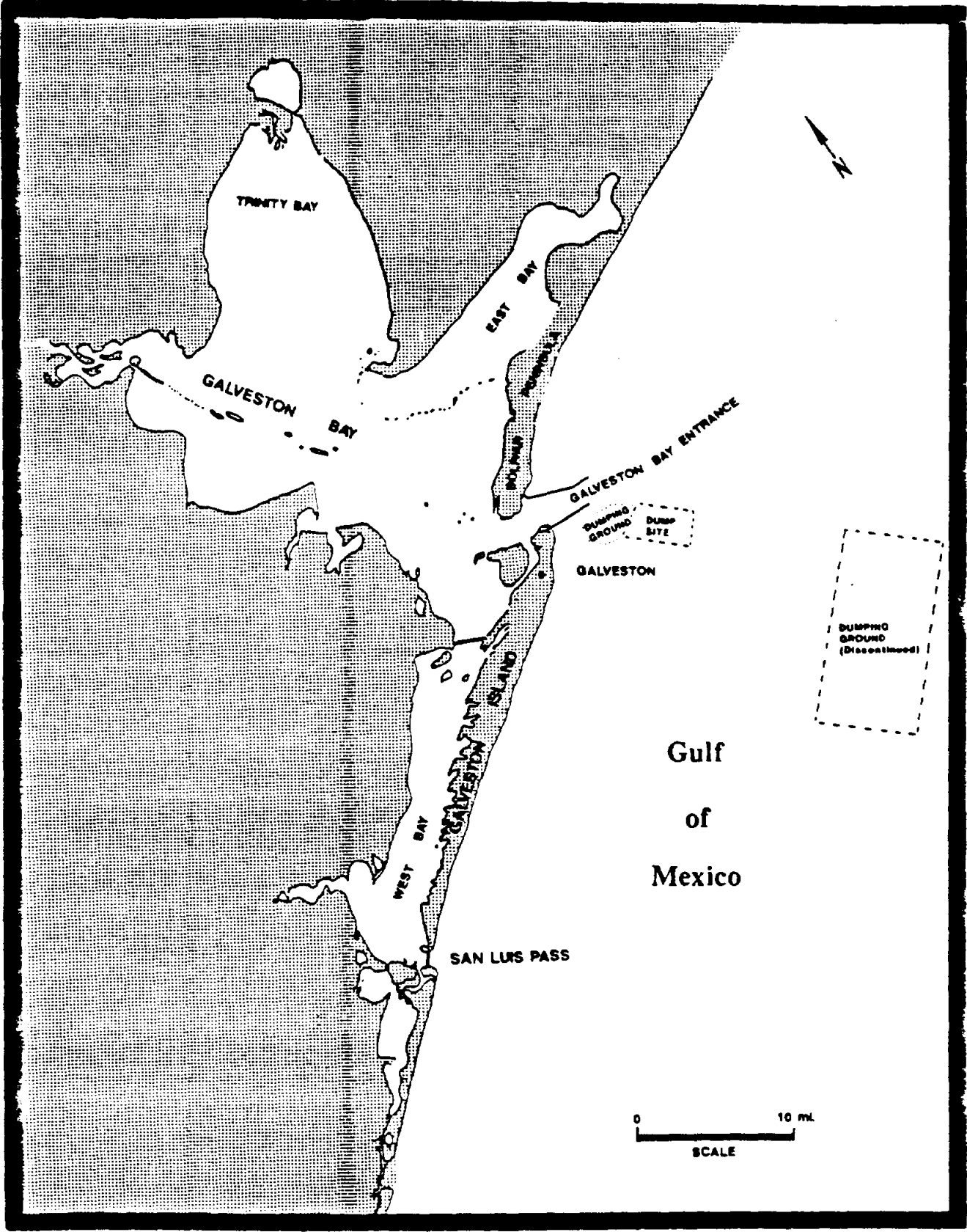

TRINITY BAY

EAST BAY

GALVESTON BAY

GALVESTON BAY ENTRANCE

DUMPING GROUND DUMP SITE

GALVESTON

DUMPING GROUND (Discontinued)

GALVESTON ISLAND

WEST BAY

Gulf of Mexico

SAN LUIS PASS

0 10 ml. SCALE



V. IDENTIFY AND PRIORITIZE PROBLEM AREAS IN THE COUNTY

A. County Zones: For Study Purposes

Dannenbaum Engineering Corporation divided Galveston County into three coastal zones: 1) Bolivar Peninsula, 2) Galveston Island, and 3) the Mainland. Each of these zones has specific problem areas which were prioritized based on a review of 1990 aerial photographs and field observation of the shores. Zones are indicated on Exhibit I, Section VII.

Coastal Problems may be classified into four generalized categories: 1) shoreline stabilization; 2) backshore protection; 3) inlet stabilization, and 4) harbor protection. These categories are discussed in Section VI.

B. Mapping of County Shoreline from 1953 to 1990 (Erosion and Accretion Rates - See Exhibits 1 - 15, Appendices)

Dannenbaum Engineering Corporation used United States Geological Survey Maps as historical base maps for Galveston County's shorelines. The 1990 shorelines were digitized from aerial photographs and placed on the photo-revised U.S. Geological Survey Maps. Erosion and accretion rates were then calculated based on shoreline differences. The accuracy of this methodology depends highly upon the accuracy of the base maps and the digitization from aerials. To increase the accuracy, aerial photographs of 1 inch equals 400 feet were used. These large photos provide greater accuracy during the plotting of 1990 shores. Inaccuracies do exist in all current systems for calculating erosion rates; however, the

review of aerial photographs is still the most widely used methodology in plotting erosion. Another method (used by the City of Galveston) is to take known NGVD data from beach monuments and accumulate erosion rates and elevation data.

It is not the intent of this planning effort to establish a legal erosion rate to be used by the state, county, city, or private sector. The calculated erosion rates of this plan are intended to provide a guide for the development of future storm damage and erosion prevention flood protection planning. Further survey and modeling is required to obtain an exact erosion rate.

C. Field Survey Report

Field Surveys were conducted July, 1991 by car and by boat. All the beaches on Galveston Island and the Bolivar Peninsula were driven during July, 1992 to observe the beach and dune characteristics and to identify and document specific problems not evident in aerial photographs. Bay shores for Bolivar, Galveston and the Mainland were observed by boat to identify and document specific problems along the bay.

1. Zone 1 - Bolivar Peninsula (See Exhibit 2, Appendices)

The Bolivar beach varies in width from 50 to 200 feet. The dunes vary in height from 4 to 10 feet. In general, the wider beaches appear in undeveloped areas and the narrow beaches appear in developed areas. Natural drainage outfall to the gulf has eroded the beaches at several locations. The intracoastal waterway runs parallel with the peninsula and

creates a barrier making parcels on the peninsula only accessible by water. Many of these unaccessible areas are used as dredge disposal sites by the Corps of Engineers. Dredge material appears to be discharged onto the islands and allowed to flow freely into the bay. The bay bottom at these discharge points is somewhat unstable. We observed 6 to 12 inches of silt within the bay off the shore of these beaches created by dredge discharging. In general, the bay shore along the peninsula is protected by grasses. The marshes along the shore are extremely important habitats for the fish and wildlife productivity within the Bay. The shoreline along the bay is shallow, except at specific cuts in the peninsula, which allow small boat traffic to pass through. Erosion at these cuts appeared very active. The banks on the south side of the intracoastal waterway range in height from 0 to 2 feet. Grasses help stabilize the south banks. The banks on the north side of the intracoastal range in elevation from 6 to 12 feet. These high bluffs appear to have been established by ponds holding the dredge material from the intracoastal waterway. These embankments protect the intracoastal from storms out of the north.

Numerous small subdivisions exist along the peninsula in Gilchrist, Caplen, Crystal Beach and Port Bolivar. Each of the subdivisions on the gulf side of Highway 87 have beach access for vehicular traffic. Driving on the beaches along the peninsula is unrestricted. Only in a limited number of

areas are vehicles not allowed on the entire beach. The effectiveness of the dune system to prevent storm surge damage has been greatly reduced due to these breaches (cuts) in the dune system. Approximately 50 dune cuts were identified in our field survey.

The peninsula drains both to the bay and to the gulf. Numerous outfall ditches empty into the intracoastal from Highway 87. Most subdivisions south of Highway 87 from Crystal Beach to Port Bolivar drain into a lagoon which runs parallel with Highway 87. The lagoon discharges at various points into the gulf. Lagoon discharges need to be routed into the intercoastal canal and the discharges onto the gulf beaches eliminated. These discharges cause beach erosion and breaches in the dune system. State Highway 87 provides the only land access and egress for the peninsula residences and businesses. This road is threatened at each end of the peninsula. There is approximately 42,250 feet (8 miles) of beach from Chambers County to Rollover. Less than 200 feet of land protects the highway from the gulf. In Chambers and Jefferson Counties, Highway 87 has been closed due to erosion damage. Prior storms have destroyed the dunes and caused the destruction of this State Highway. The likelihood of continued damage to Highway 87 due to storms and the normal erosion process is very high. The beaches and dune system currently provide the only storm surge protection. Highway 87 also faces possible erosion damage near the ferry landing.

Riprap and sand fill are constantly being dumped along the highway right-of-way to effectively create a levee for the highway's protection. Erosion in this area appears accelerated by the hard structures (retaining walls and riprap) at Fort Travis County Park. Erosion patterns created in this area are a classical case of flanking. This pattern will continue unless corrective action is taken. Highway 87 may need to be elevated to form a dike. A dune system may need to be constructed along the dike to also protect the road.

Erosion near Rollover Pass is due primarily to the tidal exchanges through out of this man-made inlet. Numerous studies have been performed on the Pass (Report on Beach Erosion Control Cooperative Study of the Gulf Shore of Boliver Peninsula, Texas (Bibliography No. 27), and Evaluation of Existing Conditions and Possible Design Alternatives at Rollover Fish Pass, (Bibliography No.2) All have indicated that the Pass is extremely erosion active, and Rollover Bay has continued to silt since the Pass was cut in the 1950's. The silting of Rollover Bay also creates increased maintenance costs for dredging the intracoastal waterway which crosses Rollover Bay.

2. Zone 2 - Galveston Island (See Exhibit 3, Appendices)

The gulf shore of Galveston Island can be divided into three areas: East Beach, the seawall, and West Beach. East Beach has continued to accrete since the construction of the jetties

in the late 1880's. The beaches in front of the seawall within the groin field were designed to stabilize but have eroded to their current locations. West of 61st Street beaches have also eroded. Over 200 feet of beach width has eroded in front of the seawall west of 61st Street. Stairs in front of the seawall west of 61st Street now lead to rock revetment which protects the toe of the seawall. Beaches have eroded away. Gulf waters now hit rock revetments at the base of the seawall west of 61st Street. This action is creating additional erosion at the base of the revetments. A dropoff of 2 to 4 feet exists along this section of the seawall. Scouring and erosion of subsurface sediments will continue along the section of shore because of the lack of a beach. The attached illustration (on Page 74) shows what has occurred and what will occur unless corrective action is taken.

The stone revetments have subsided due to their foundation being washed out or weakened in several areas. This subsidence will probably continue unless the beach is restored. Waves could eventually be breaking against the seawall if the beach is not restored. This would be an undesirable condition. The beaches west of the seawall vary in width from 50 to 180 feet. Dunes west of the seawall vary in height from 4 to 10 feet. In general, beaches are wider in the area where development has not occurred and narrower in areas where development exists. Vehicular access is allowed



in limited areas on West Beach. Eighteen breaches (cuts) in the dune system provide vehicular access.

The west bay shores of Galveston Island consist of grassy wetlands where development has not occurred. These shorelines are protected by salt grasses. Where organized development has occurred, bulkheads of various materials have been installed. Bulkheading generally consists of treated wood, concrete, metal, or a combination of these materials. The bay along most of the island is extremely shallow, making access even by boat extremely difficult. Channels have been cut from deeper waters in the bay to the various subdivisions along the Island. Typically, material removed by dredging is placed on shore behind bulkheading to build up the land within the development. Generally, bulkheads within the west end developments are well kept. There are some damaged bulkheads on undeveloped lots. These bulkheads appear damaged by erosion and by lack of maintenance.

The shores along Offatt Bayou appear relatively stable because of extensive bulkheading and revetments. In one area, however, the bayou has eroded extremely close to the feeder road at Interstate 45. Erosion also appears to be threatening Travel Air Drive near the Crash Basin.

Galveston Bay from Interstate 45 to the Pelican Island Bridge appears stable in areas where bulkhead and revetments have been installed due to structural restraints. Erosion is occurring at different rates along this section of the bay.



Erosion is slowly encroaching on Port Industrial Road at one location and the Pelican Island Causeway approach.

3. Zone 3 - The Mainland

The lower Mainland shores of the west bay consist mainly of grassy marshland. The banks along the intracoastal waterway from Jones Bay to the Brazoria County Line are relatively undeveloped except for the McGines pits and the old Flamingo Isle development. Grasses protect the shores along the intracoastal waterway. Dredge material from the waterway is discharged openly onto the Island between the intracoastal and west bay. Dredge discharges have formed high bluffs which protect the intracoastal and mainland shores (marshlands) from high winds and waves. The shores of Jones Bay consist of grassy marshland and appear stable. The marshland on the mainland is threatened by further subsidence and sea level rise.

Galveston Bay from the causeway to Snake Island is also grassy marshland except for a stone revetment around Snake Island. The majority of the shoreline of the bay from Snake Island to the Brazoria County Line is unprotected shores. The Texas City Dike provides a protective barrier for this section of the bay. A stone revetment around Snake Island has been enlarged substantially from 1974. Snake Island has been elevated by dredge fill from the Texas City Channel. The south side of the Texas City Dike is stabilized through the use of large stone revetments. The north side, while

appearing stable, is subject to wave action from across the bay and from Houston Ship Channel traffic. Concrete riprap is continuously being placed along the banks for protection.

4. Aerial Photos

The following aerial photos graphically illustrate the erosion problem along Galveston County's shores. Photos of the three zones, Bolivar, Galveston, and the Mainland, are presented. The photos clearly indicate the need for a management plan which better utilizes our sand resources, in certain areas and structural protection in others. Sand resources have been identified by Sediment Distribution, Sand Resources, and Geologic Character of the Inner Continental Shelf Off Galveston, Texas (Bibliography No. 23) and available sand quantities estimated. These locations are generally shown on Exhibit "I", Appendices.

D. Problem Areas

1. Erosion Rating

This plan is intended to review and update prior reports and studies, thereby identifying and prioritizing the shoreline erosion areas in Galveston County which are responsible for substantial flood damage and property loss. A National Shoreline Study Texas Gulf Shore Regional Inventory by The United States Army Corps of Engineers, page 14, (1971) defined critical erosion areas as "where the rate of erosion indicates that action to halt the erosion may be justified, when considered."

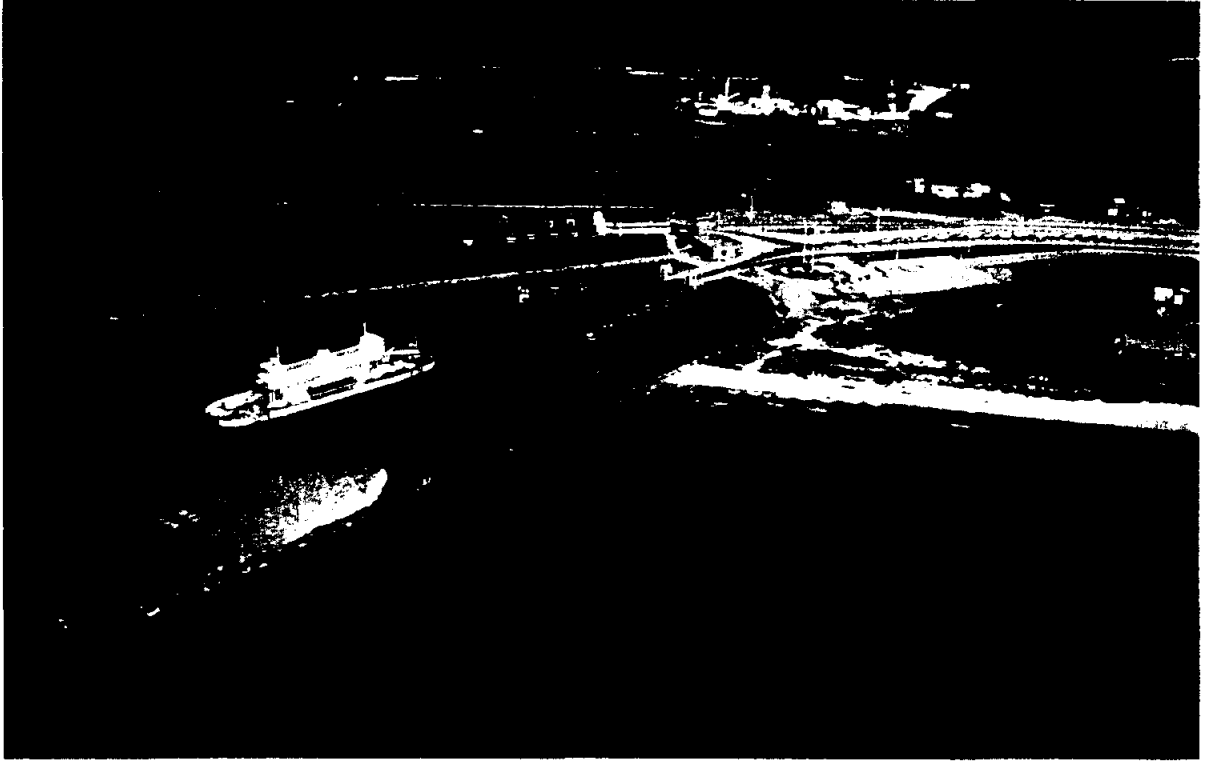

**BOLIVAR - FERRY LANDING**



**BOLIVAR - WEST FORT TRAVIS: FLANKING**



**BOLIVAR - FORT TRAVIS**



**BOLIVAR - EAST FORT TRAVIS: NARROW BEACHES**



**BOLIVAR - ROLLOVER PASS: HOUSES THREATENED**



**BOLIVAR - ROLLOVER PASS: EROSION**



**BOLIVAR - ROLLOVER PASS: EROSION**



**BOLIVAR - HIGHWAY 87: EROSION**

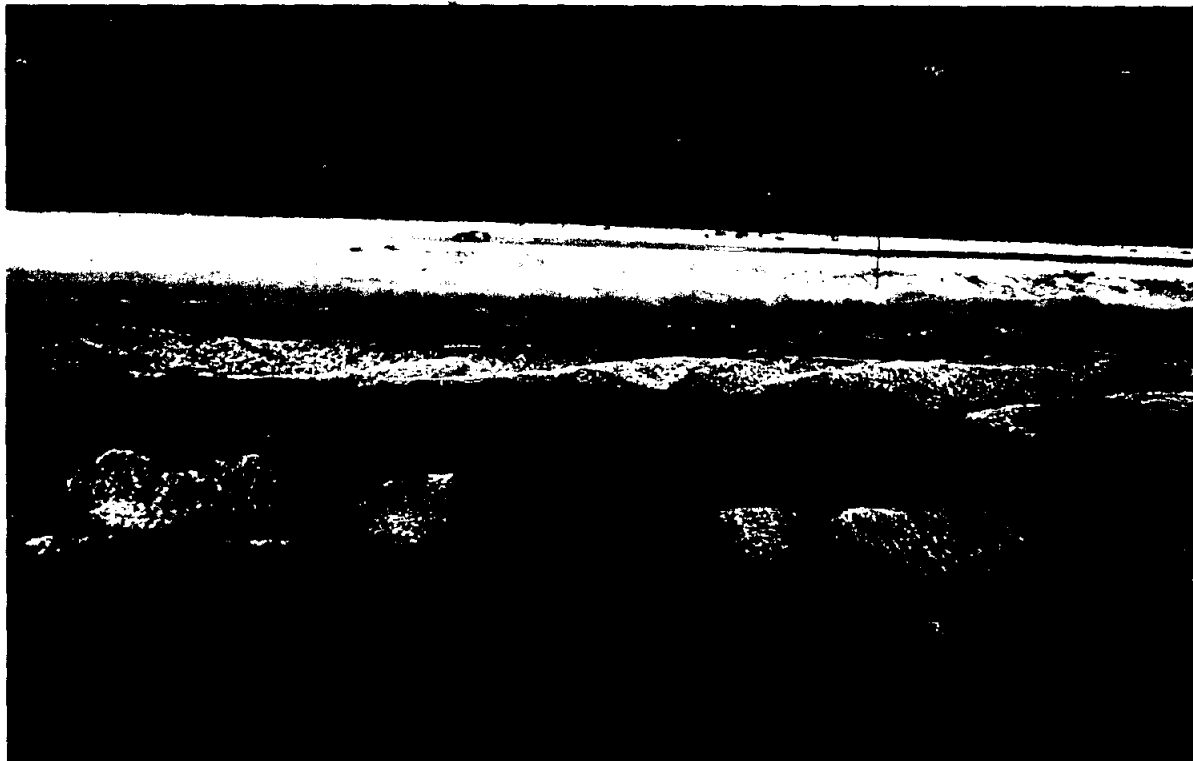

**BOLIVAR - HIGHWAY 87 EAST OF HIGH ISLAND**



**BOLIVAR - HIGHWAY 87 EAST OF HIGH ISLAND**



**SAN LUIS PASS - BRIDGE APPROACH ROAD**

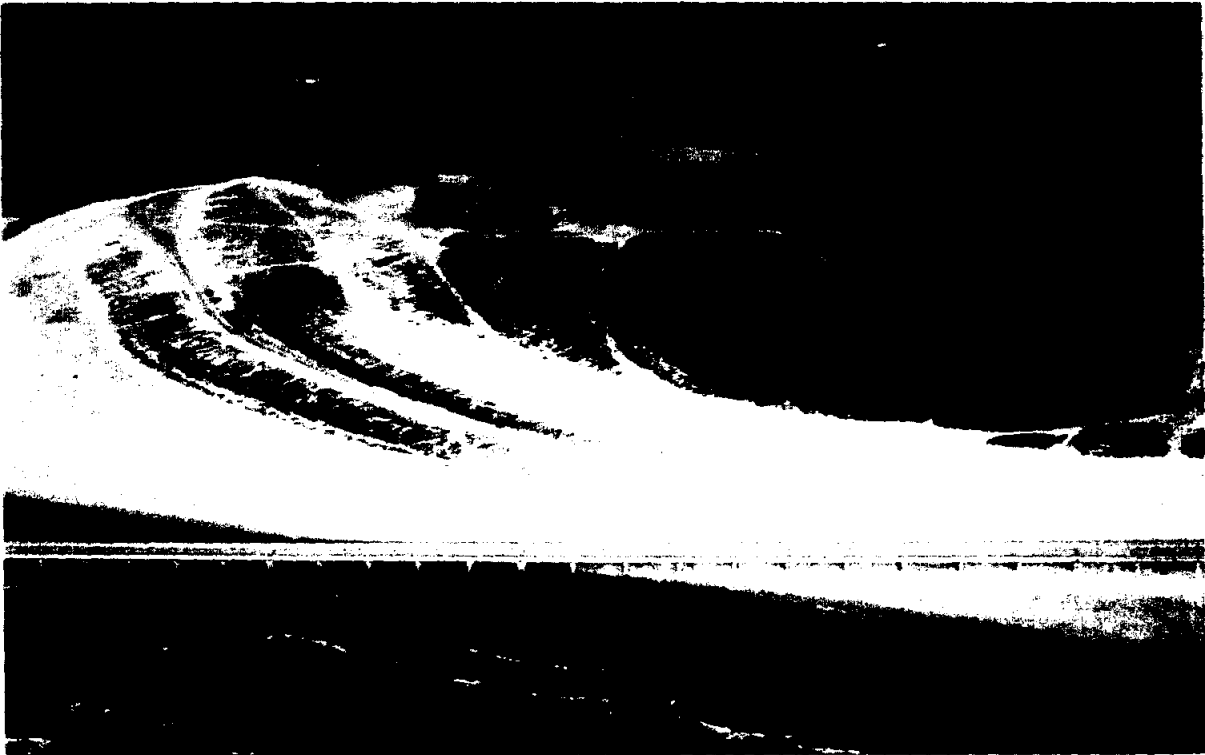

**SAN LUIS PASS**





**SAN LUIS PASS**

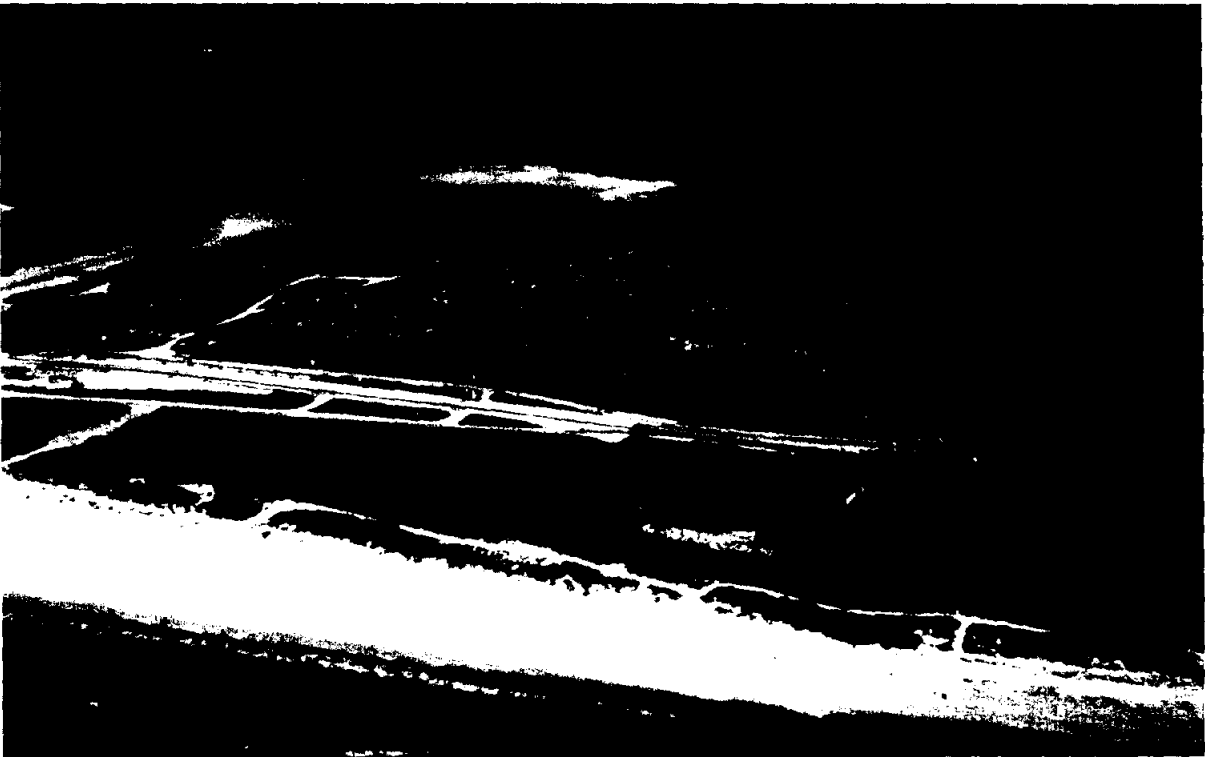

**SAN LUIS PASS - BRIDGE APPROACH**



**GALVESTON - SEA ISLE**



**GALVESTON - SEA ISLE**



**GALVESTON - WEST BEACH**

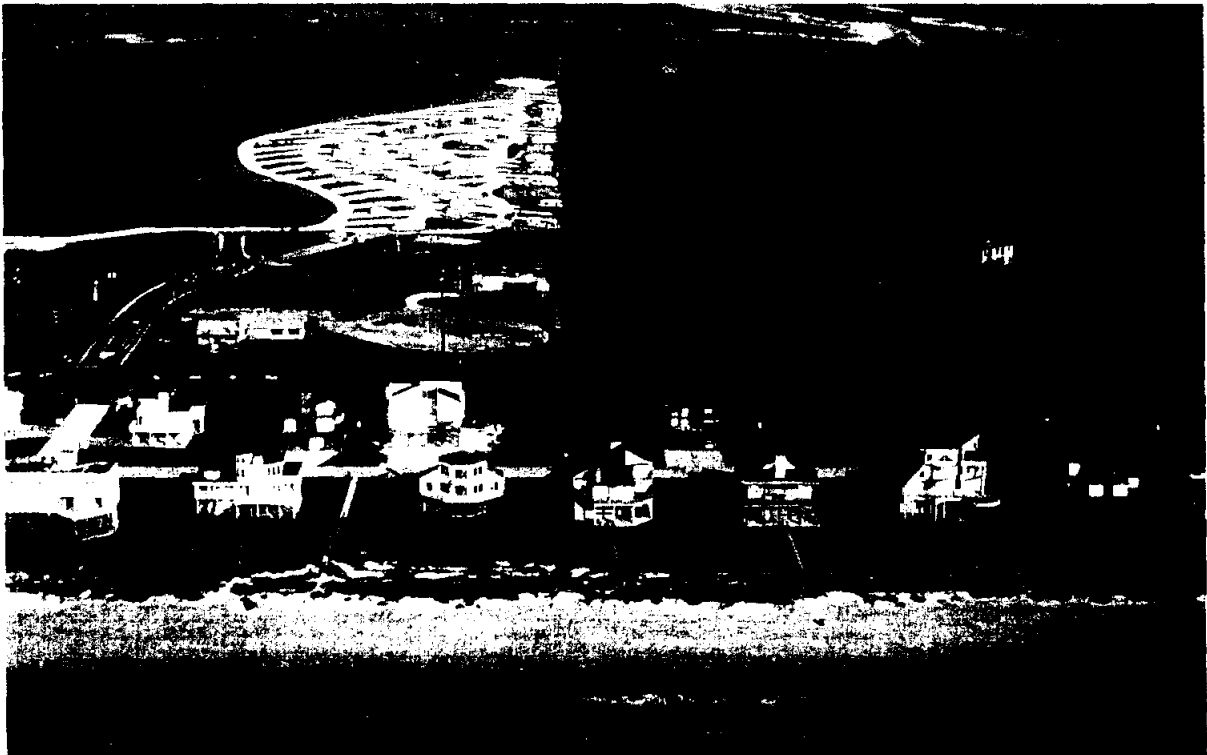

**GALVESTON - WEST BEACH: DUNES THREATENED**



**GALVESTON - DE VACA: DUNES THREATENED**



**GALVESTON - DE VACA: DUNES THREATENED**



**GALVESTON - GULF PALM: TYPICAL DUNE BREAK**

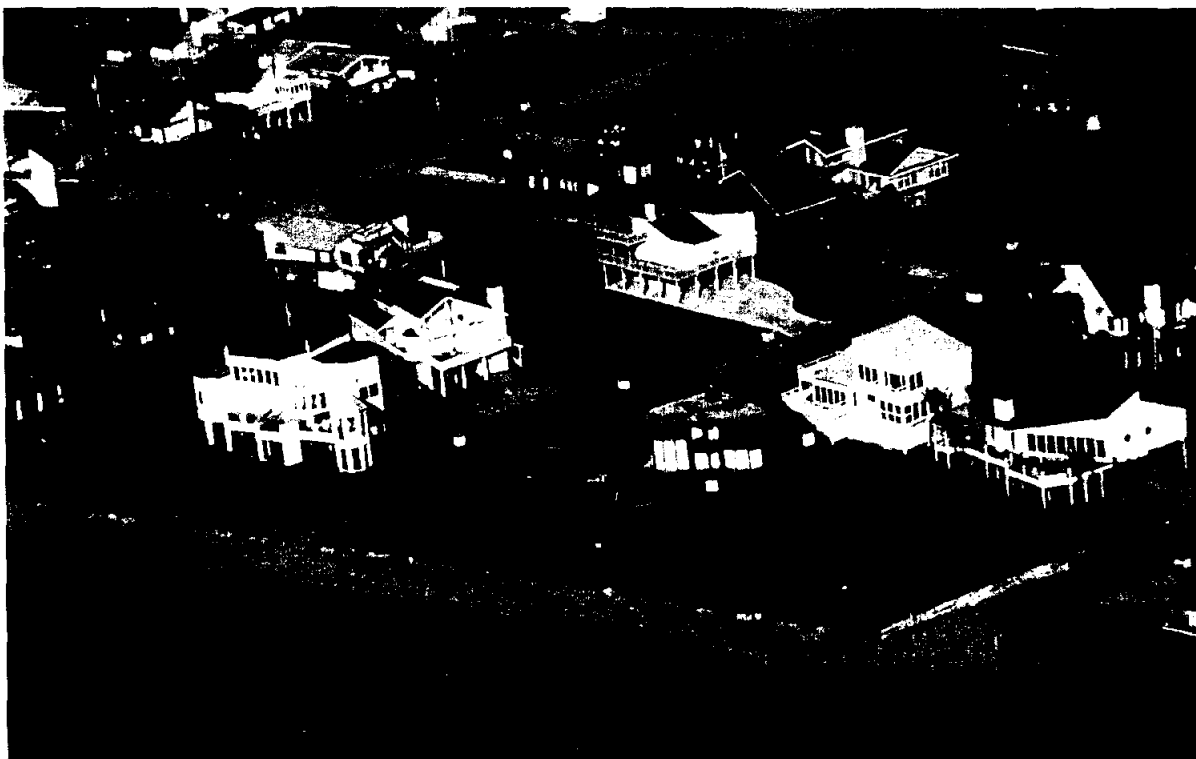

**GALVESTON - PIRATES BEACH: DUNES THREATENED**

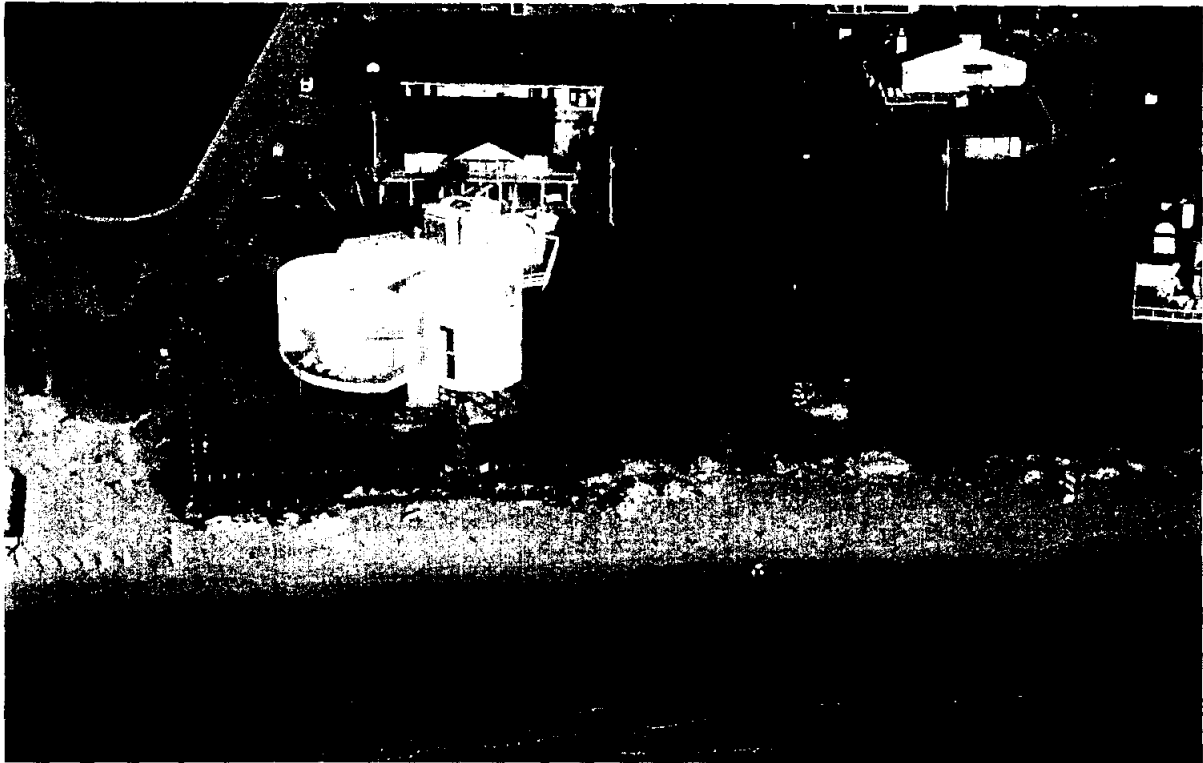

**GALVESTON - PIRATES BEACH: DUNE BREAK**



**GALVESTON - PIRATES BEACH: DUNE BREAK**

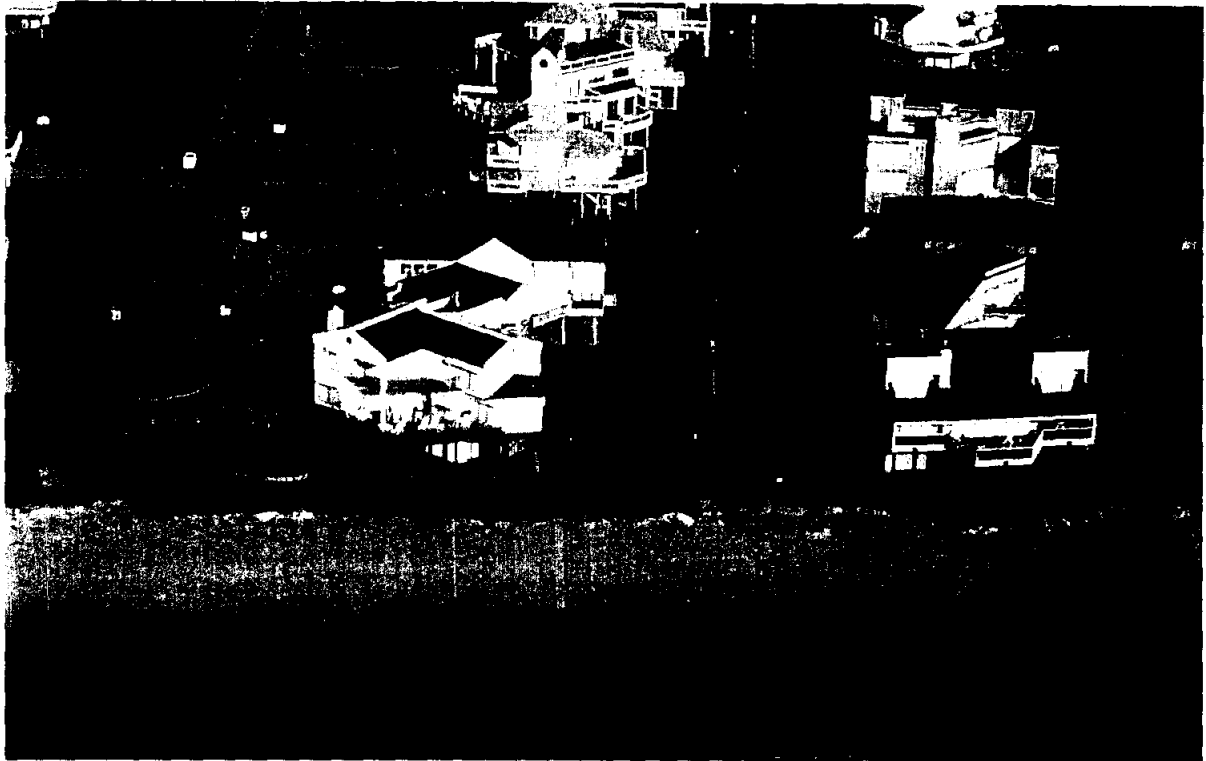

**GALVESTON - PIRATES BEACH: DUNES THREATENED**

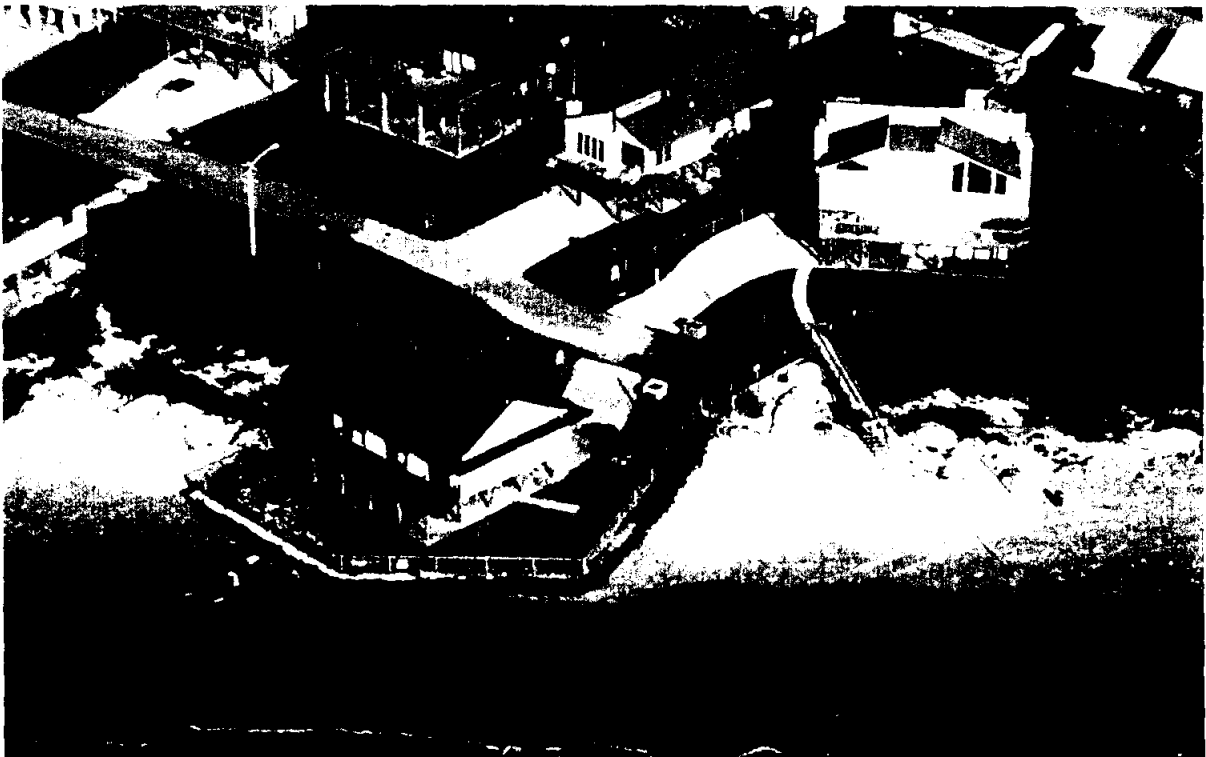

**GALVESTON - SPANISH GRANT: DUNES THREATENED**

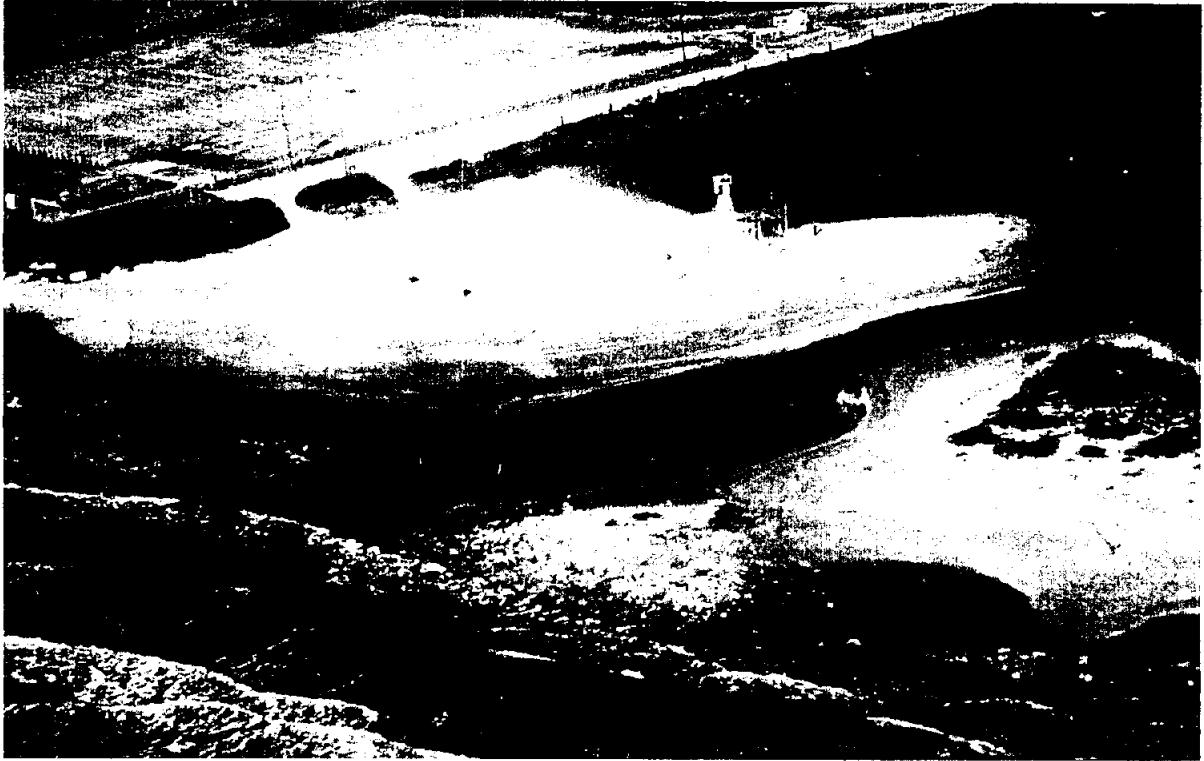

**GALVESTON - HENDERSON HOLE: ERODED BEACH**



**GALVESTON - HENDERSON HOLE: ERODED BEACH**



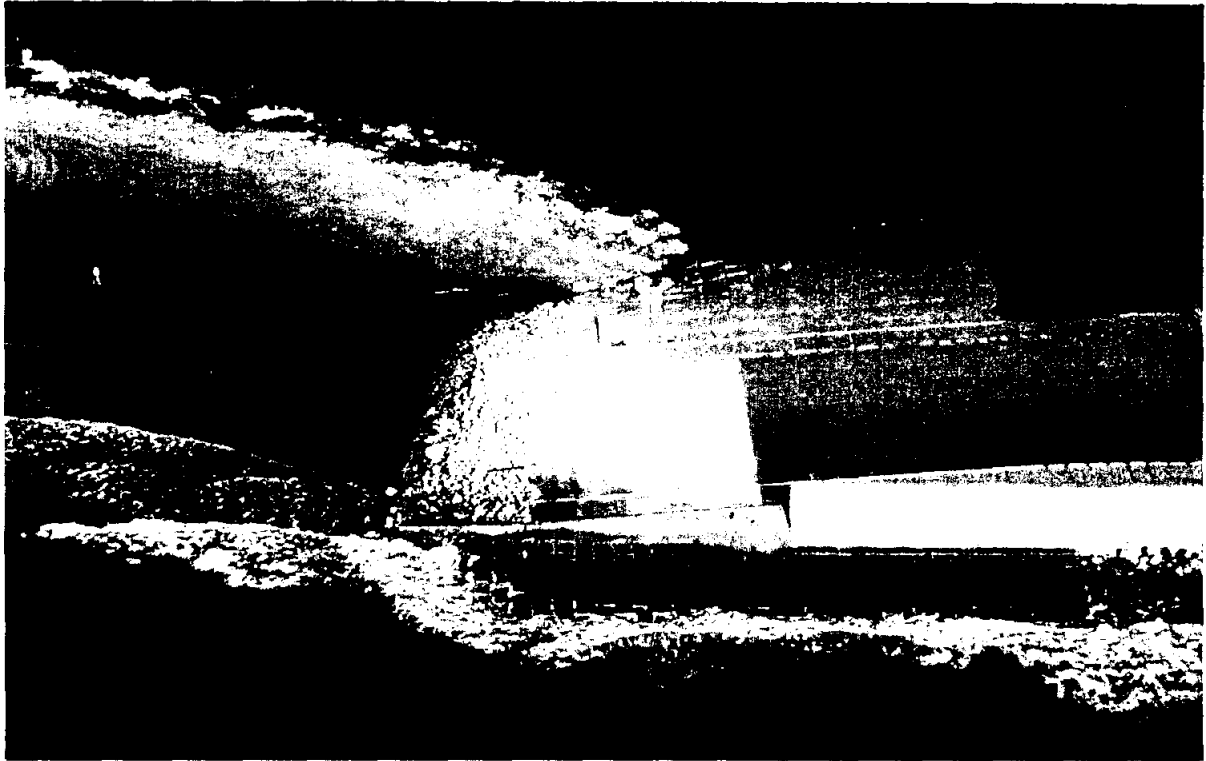

**GALVESTON - SEAWALL FLANKING WEST END**

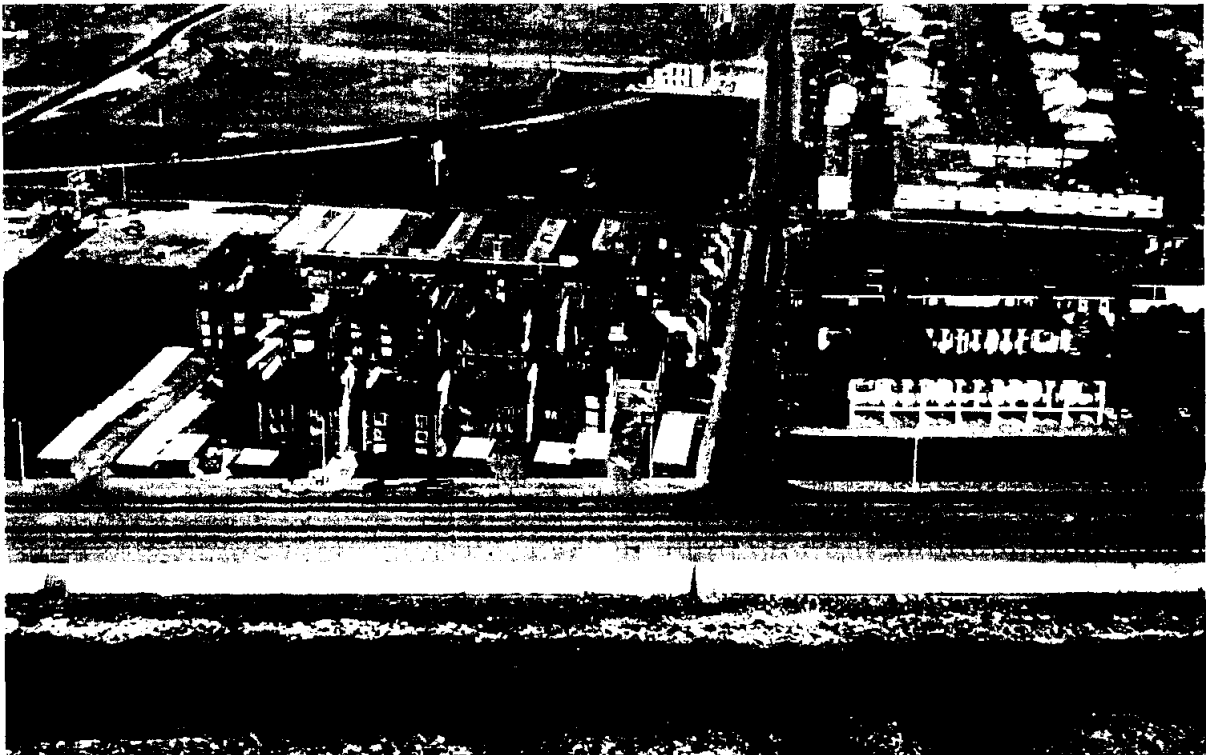

**GALVESTON - SEAWALL STAIRS TO NO BEACH**



**GALVESTON - SEAWALL STAIRS TO NO BEACH**



**GALVESTON - 61ST STREET GROIN**



**GALVESTON - 59TH STREET: SEAWALL DOWN RAMP TO NO BEACH**

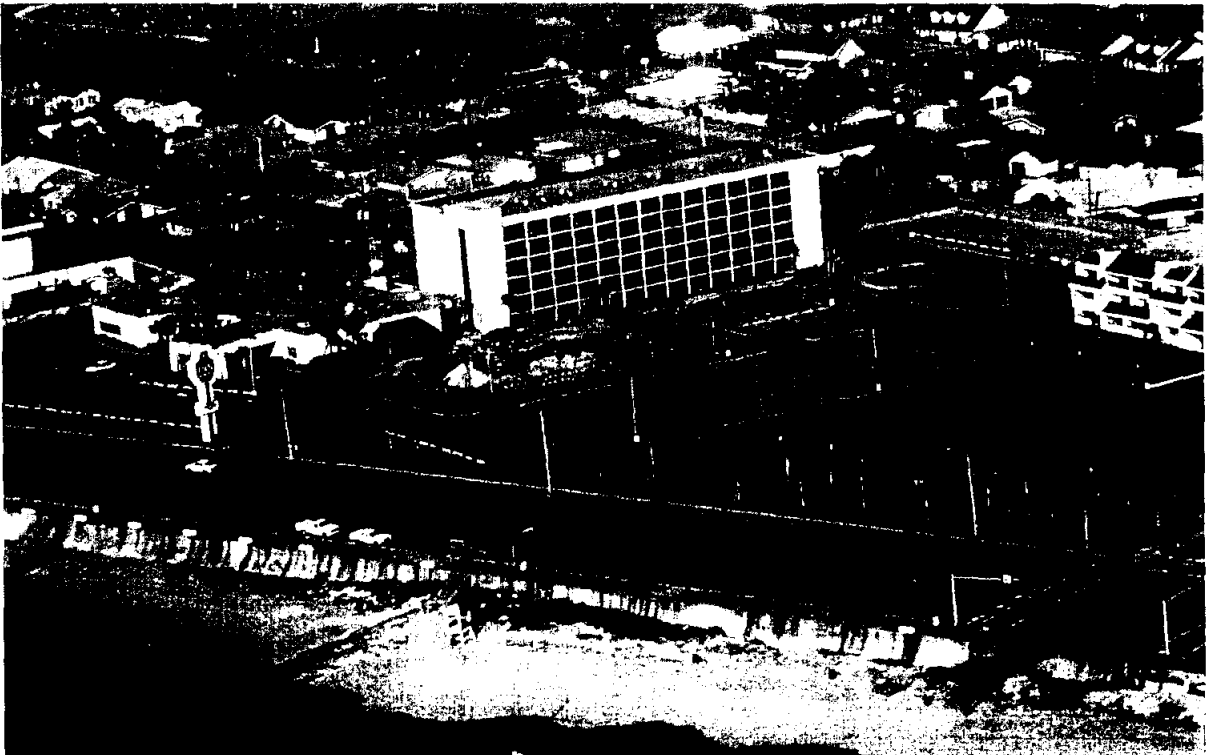

**GALVESTON - 53RD STREET: RE-NOURISHED BEACH**



**GALVESTON - 27TH STREET: GROINS**

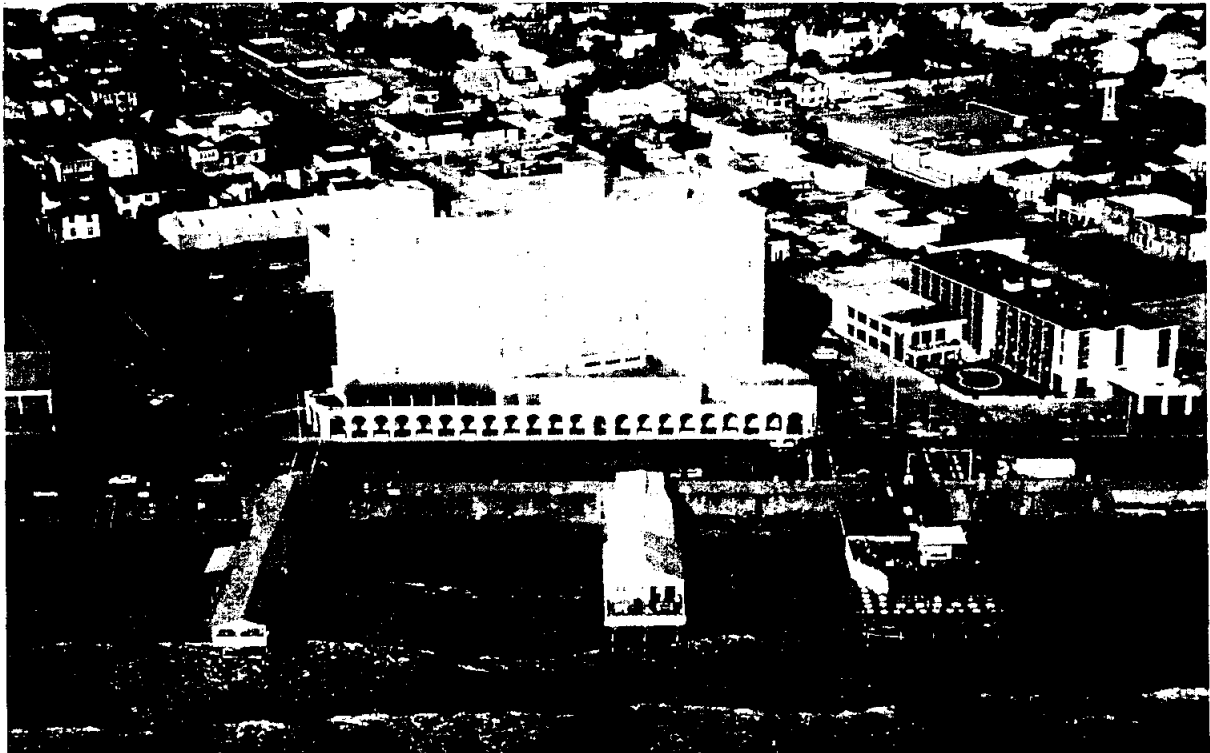

**GALVESTON - SEAWALL: BEACH EROSION**

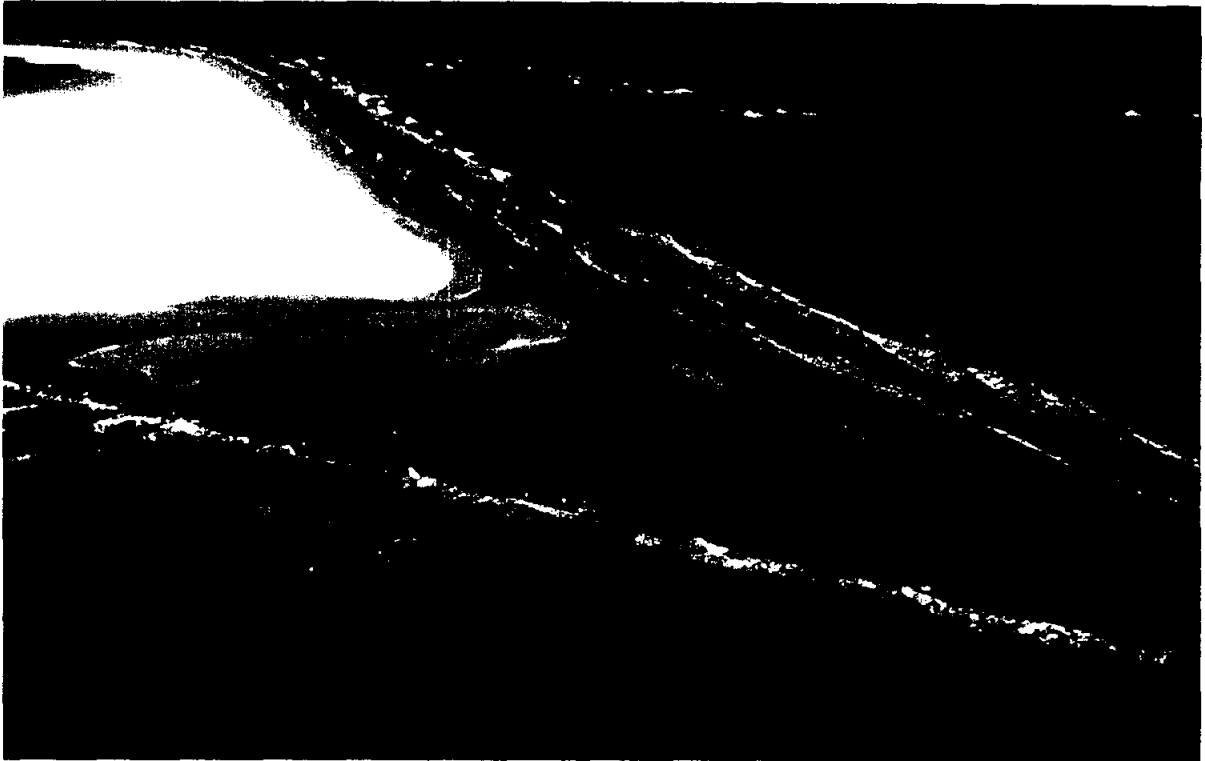

**GALVESTON - BIG REEF SOUTH JETTIES: SAND SOURCE**

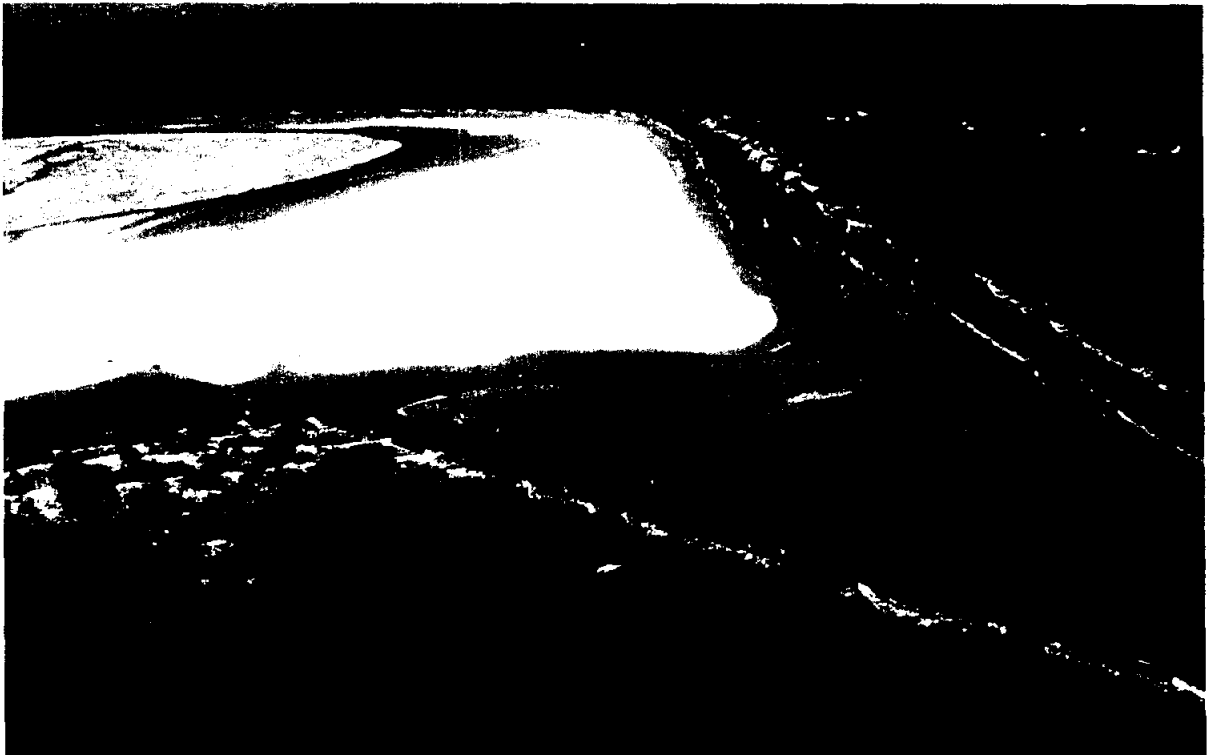

**GALVESTON - BIG REEF SOUTH JETTIES: SAND SOURCE**



**GALVESTON - BIG REEF SOUTH JETTIES: SAND SOURCE**



**GALVESTON - BIG REEF SOUTH JETTIES: SAND SOURCE**



**MAINLAND - TEXAS CITY: EROSION BASE OF LEVEE**

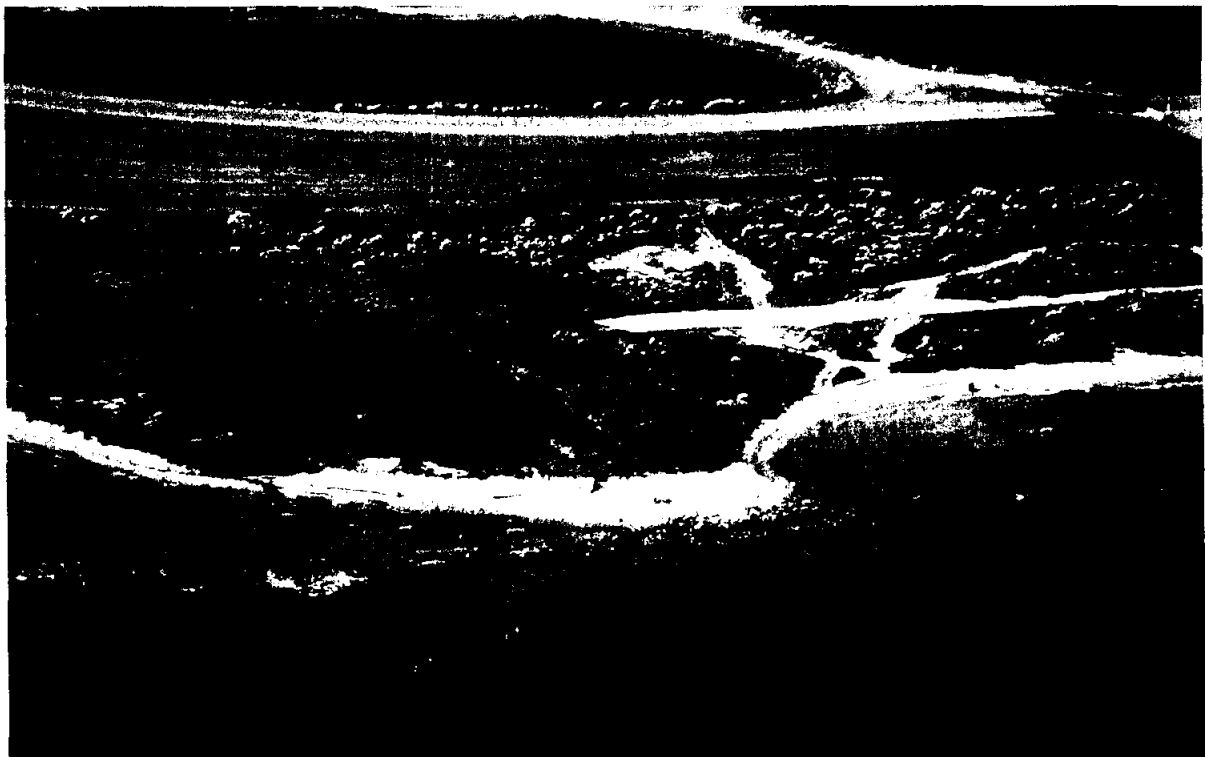

**MAINLAND - TEXAS CITY: EROSION BASE OF LEVEE**

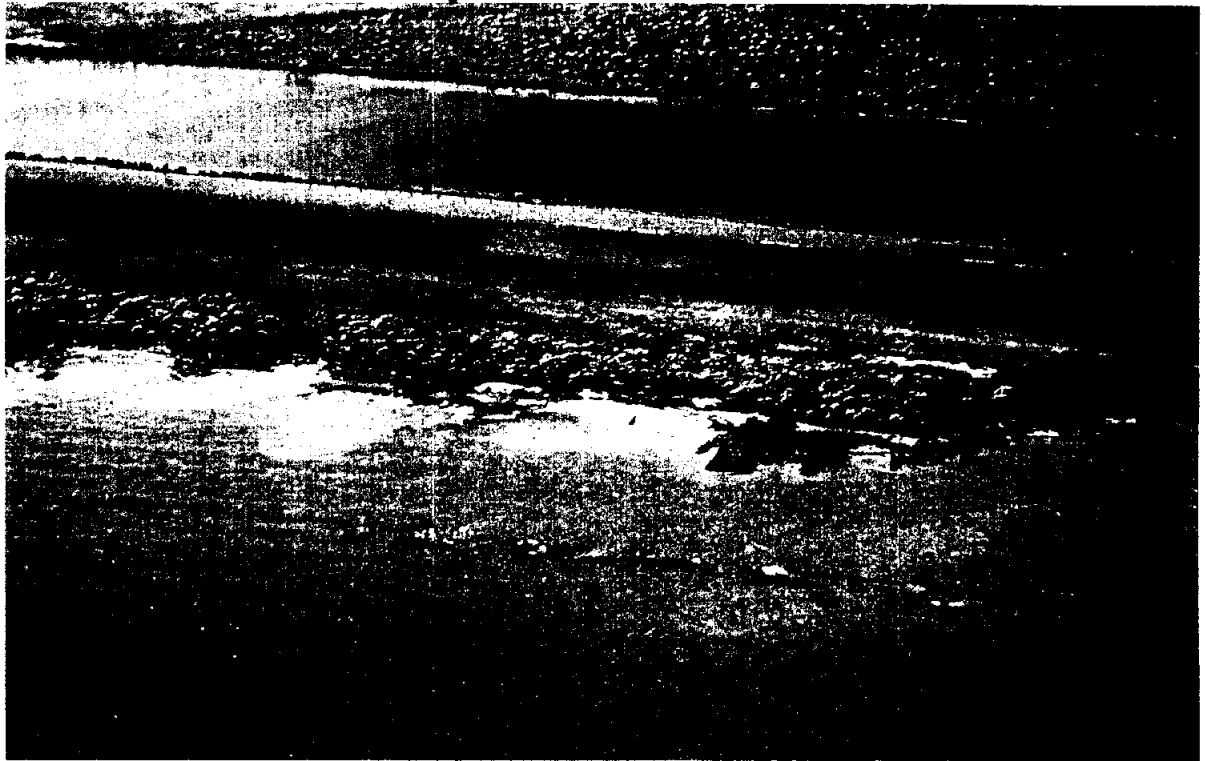

**MAINLAND - TEXAS CITY: EROSION BASE OF LEVEE**

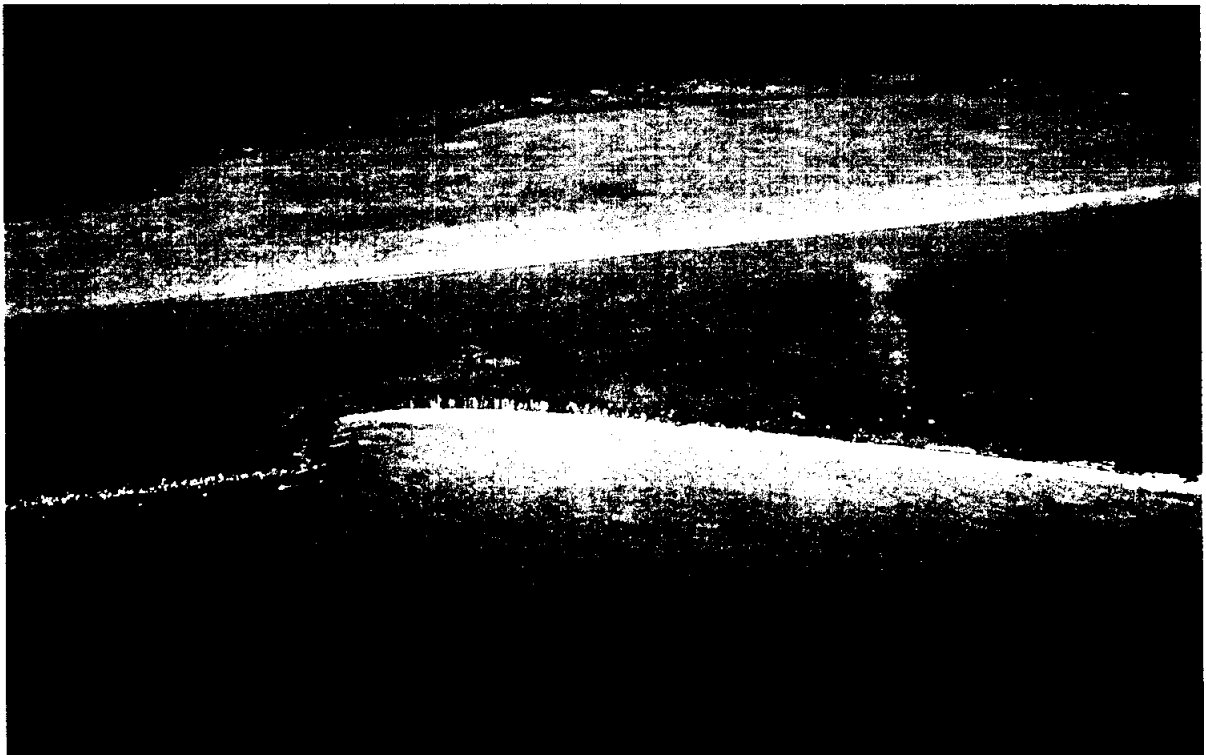

**MAINLAND - TEXAS CITY: EROSION BASE OF LEVEE**





**MAINLAND - TEXAS CITY: EROSION BASE OF LEVEE**



**MAINLAND - SAN LEON: BULKHEADING**



**MAINLAND - SAN LEON: BAY SHORE EROSION**



**MAINLAND - SAN LEON: BAY SHORE EROSION**

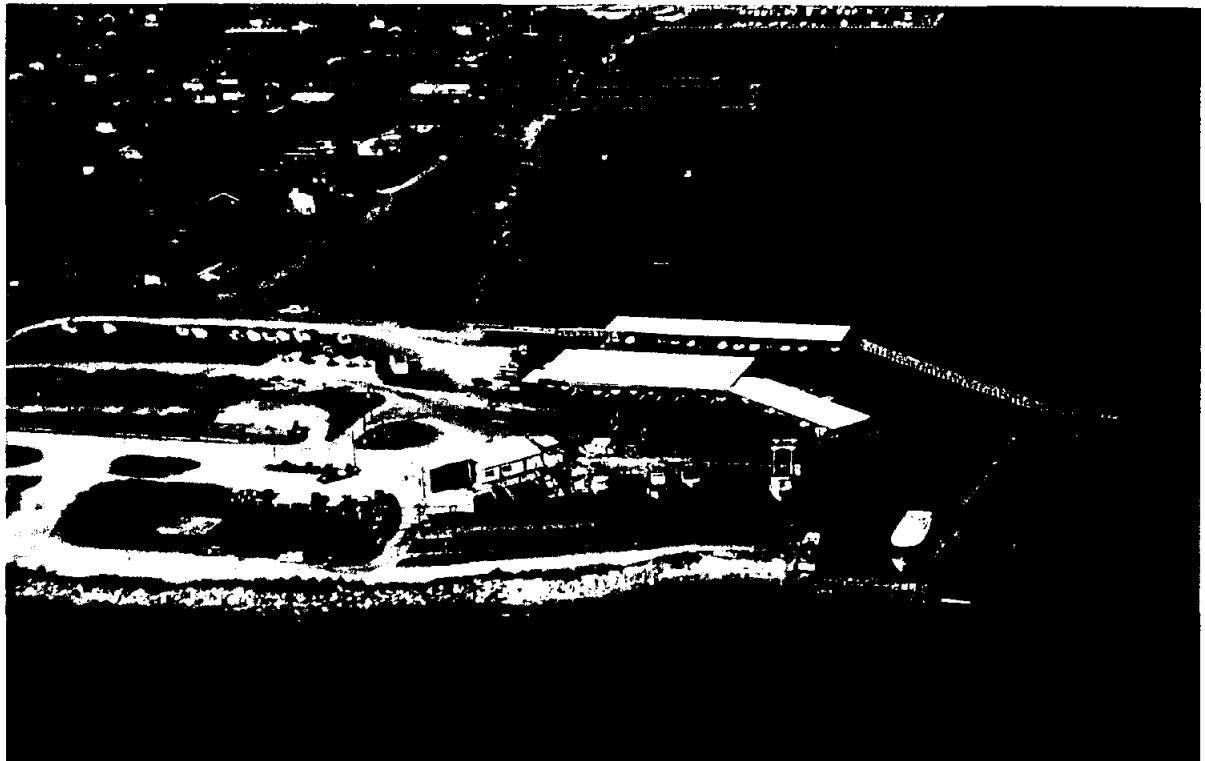

**MAINLAND - SAN LEON: BAY SHORE EROSION**

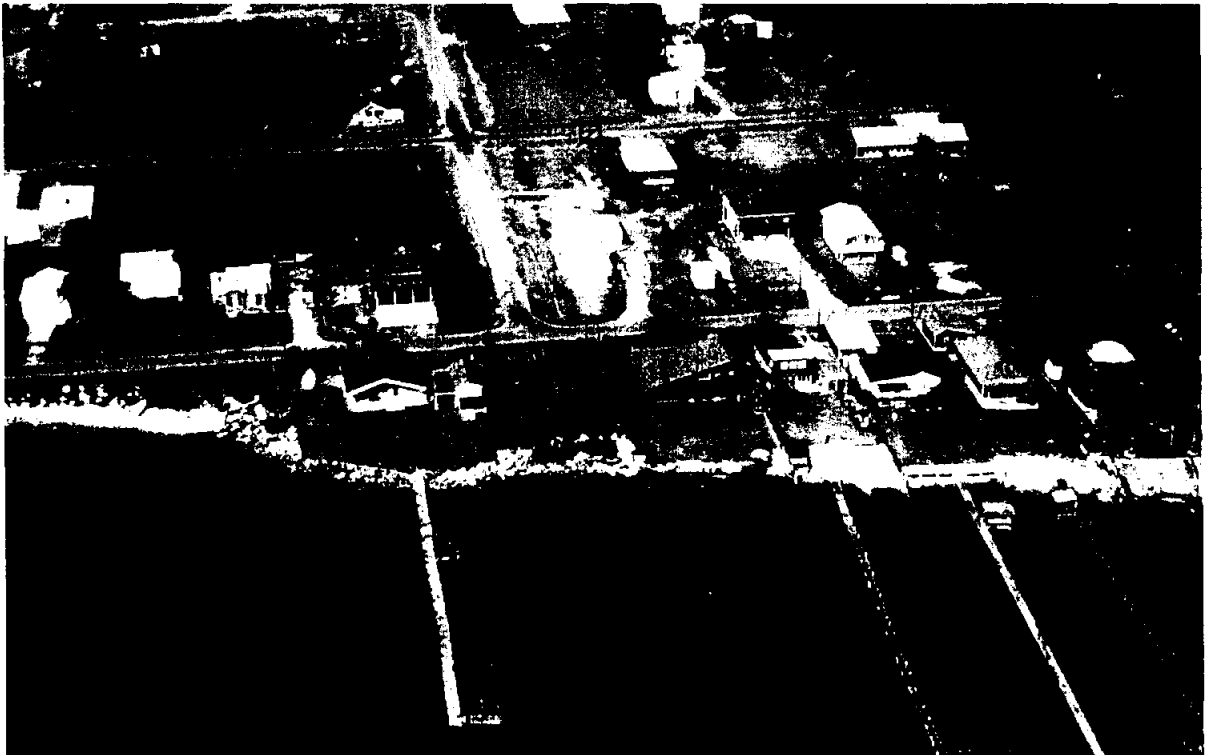

**MAINLAND - SAN LEON: BAY SHORE EROSION**

All erosion problem areas could be indicated on the coastal maps of the County. These maps could to provide general location guidance to the user. The erosion problem areas could be named in accordance with the best description of their geographical location.

Some other areas of the County identified as having low, moderate, or no erosion problems (see Page 78A for definitions) may become an erosion problem area if additional development occurs. In other areas, the currently low or moderate erosion rates may be substantially accelerated. Changes in weather conditions and unpredictable major storm events will play a predominate role in the creation or deletion of erosion problem areas. The list of Galveston County's erosion problem areas will probably continue to expand given long term growth of coastal development and recreation interests, the rise in sea level, and the growing shortage of available sand to naturally replenish the beaches during major coastal storm erosion events. For these reasons, the focus of this study was to investigate the system which not only re-establishes the eroded area, but helps retain the restored areas.

THE EROSION PROBLEM AREAS  
CATEGORIES

- I. High erosion rate or recent significant erosion conditions.
- II. Moderate or low erosion rate.
- III. Restored beaches with an active maintenance nourishment program or stable beaches.
- C. Critical erosion areas where substantial development, recreational interests or utility services are threatened.
- N/C. Noncritical erosion areas where the erosion processes do not currently threaten any substantial development or recreational interests.

Erosion Problem Area      I      II      III      C      N/C

BOLIVAR PENINSULA

GULF:					
High Island	X			X	
Gilchrist	X			X	
Rollover Pass	X			X	
Crystal Beach		X			
Point Bolivar		X			
BAY:					
Point Bolivar	X	X			
Crystal Beach		X			X
Rollover Pass		X			X
Gilchrist		X			X

GALVESTON ISLAND

GULF:					
East Beach			X		X
Groin Field			X	X	
West Seawall	Note 3			X	
West Beach	X	Note 2		X	

Erosion Problem Area        I          II          III          C          N/C  

**GALVESTON ISLAND**

BAY:					
West End		X			X
Port of Galveston		X		X	
East End		X			X

**MAINLAND**

West Bay		X			X
Tiki Island		X			X
Texas City					
Texas City Dike		X			X
San Leon		X		X	
Bacliff		X		X	
Kemah		X		X	

**\* Note:**

1. The basis of this comparison was established by comparing maps prepared at various times and by observing erosion problem areas during visits to the sites. The accuracy of erosion rates and erosion losses is limited to the accuracy of the maps used (i.e. 1953 - 1990).
2. Some of the west beach is accreting.
3. The west end of the seawall was not constructed until 1962.

2. Listing and Description

Each problem area identified was evaluated to determine its impact on the coast. High erosion areas with little negative impact did not have a high priority ranking. High problem areas that could have a severe effect on the health, safety, environmental, and economic condition of the region were designated high priority. The highest problem areas are listed first and the remaining problem areas are then listed in descending order.

A. Zone 1 - Bolivar Peninsula (See Exhibit 4, Appendices)

1. Shoreline Stabilization

a. Phase One - Gulf Shores from High Island to Rollover

This section of the Gulf shore is ranked as the highest problem area within Zone 1 because potential loss of Highway 87 would cut off access to the mainland. Sixty-two acres have been lost to erosion from 1953 to 1990 in this 44,500-foot section of beach. The 1.64 foot per year loss was determined by overlaying shoreline maps of those dates and measuring the acreage lost. The accuracy is limited by the accuracy the mapping and projections are intended primarily to indicate trends. This section of the peninsula is relatively undeveloped. Portions of this beach have been declared a restrictive zone based upon the Coastal Barrier Resource Act of 1990. This designation prevents the issuance of federal flood insurance and other federal assistance for

development within the area. Highway 87 provides the only land access from the peninsula.

The Highway 87 R.O.W. is 100 to 150 feet from the Gulf shore near High Island. If this road were destroyed, the peninsula would be cut off from the Mainland. Dunes 4 to 8 feet are the only highway protection. Highway 87 above High Island has eroded into the Gulf, and a severe storm would result in loss of the dune protection and thus allow highway damage. A safe evacuation route is essential for the residents of the peninsula and needs to be maintained.

b. Phase Two - Gulf Shores from Rollover to Caplen

This section of Gulf shore ranks as the second highest problem area within Zone 1. Sixty acres have been lost to erosion from 1953 to 1990 in this 14,000-foot section of beach. Erosion has been approximately 6 feet/year. This section of the Bolivar Peninsula has one of the highest erosion rates due to Rollover Pass. Houses have been lost in the past and more homes are threatened at this time. Storm damage would probably destroy several homes.



c. Phase Three - Gulf Shores Along Crystal Beach

This section of the Gulf Shore includes numerous subdivision developments along the peninsula. It is the most populated area on the peninsula. Two acres have been lost to erosion in this 28,000-foot section of beach from 1954 to 1990. This area is not considered a high erosion zone; however, the base flood elevation for the peninsula has been raised resulting in many homes being below the base flood elevation. Additional storm surge protection is needed for these residences.

d. Phase Four - Gulf Shores West of Crystal Beach

This 10,000-foot section of beach stretch has lost 20 acres of land from 1953 to 1990. This area is less developed and is not considered a high erosion zone but, like Area D above, the base flood elevation has been raised and many existing homes are now below the base flood elevation. Additional storm surge protection is needed for these residences.

e. Phase Five - Highway 87 at Fort Travis

The shoreline between Fort Travis and the current Ferry Landing (6,000 feet) is a high erosion zone. Fifty-two acres have been lost to erosion from 1953 to 1990. This equates to 10.2 feet per year loss. The shoulders of Highway 87 are underwater during severe tidal changes and a severe storm could possibly damage the highway preventing ferry use.

f. Phase Six - Rollover Pass

The beaches on each side of Rollover Pass have continued to erode. New bulkheads proposed to stabilize the inlet banks extend to the Gulf shores. The termination of the hard structures will cause additional erosion of the beaches. A system is needed to prevent erosion and trap sediments along the Gulf shore. Beaches on both sides of the jetties should be replenished periodically as part of the intracoastal dredging maintenance cycle.

g. Phase Seven - Sievers Cove/Stingray Cove

These openings from the intracoastal waterway provide water access to East Bay. The shore of these openings have eroded. Additional increases in the opening will expose development on Peninsula to increasing wave action from the bay.

2. Inlet Stabilization

a. Rollover Pass

Rollover Pass has been studied by numerous entities. Each has concluded the Pass is unstable. The movement of tidal waters in and out of Rollover Bay has accelerated erosion. The intide movement carries sediment into Rollover Bay. A system is needed to reduce Gulf shore erosion and block sediment flow into the bay.

3. Backshore Protection

a. Dune Breaks Along the Peninsula's Gulf Shores

Fifty-three dune breaks exist along the Peninsula allowing storm surges to enter the backshore area. Each of these openings is a break in the natural storm protection system. Development adjacent to the dunes as well as a decreased sediment supply has created a decline in the size of the dunes. This reduces their storm protection capabilities. Dune openings should be closed to prevent storm surges from entering the backshore area.

b. Dune Height Along the Peninsula's Gulf Shores

Continued erosion along the upper Texas coast and the reduction in sediment availability along the upper Texas coast has decreased beach width, thereby reducing dune heights. Subsidence and sea level rise has also contributed to the decrease in elevation of the dunes. A dune enhancement program should be developed.

B. Zone 2 - Galveston Island (See Exhibit 5, Appendices)

1. Shoreline Stabilization

a. Phase One - Groin Field Gulf Shores - 10th Street to 61st Street

This is the highest priority because of the visibility and not potential damage to the seawall. This 24,000-foot section of beachfront is the most highly

visible stretch of beach within the County. The above water usable beach within this reach has continued to diminish since the seawall was constructed. Groins were installed to retain sediment in front of the seawall; however, the original design of the "above water" beach has never been established. Since the 1930's, the Corps has been trying to get the City to artificially nourish its beaches by hauling in sand because the groin cells have not filled naturally. Nourishment is needed to provide full protection to the toe of the seawall. The erosion rate along this section of beach is not high, but the protection of the seawall toe is essential. Corps reports that indicate storm damage for various hurricanes do not specifically break down damage cost except in the Hurricane Carla report of 1961. According to the report, this storm caused \$150,000 damage to the seawall toe east of 61st Street. At today's cost, the storm damage would increase and the amount of damage would also increase due to the reduction in above water surface beach sand. Replenishment of the beach in front of the seawall would provide the original designed beach for the groin field. The Corps and the City of Galveston are working on a plan to replenish the beaches by using dredged materials from the Corps maintenance dredging program for the waterways near Galveston. Drainage along this section of seawall is generally provided by sheet flow over the wall and onto the beach. However, from 18th Street to 35th Street

a raised sidewalk with curbs is provided along the top of the seawall with curb inlet No.5 for drainage. This provides a concentrated flow of water at each discharge point causing erosion of beaches. Erosion prevention methods are as referred to in Texas A&M's Report located on Page 68A.

b. Phase Two - Seawall - Gulf Shores - 61st Street to 8-Mile Road

This 11,200-foot section of Zone 2 is ranked as the second highest priority. The erosion rate in this zone is high. Beaches in front of the seawall have eroded leaving the water's edge against the base of the seawall. Stairs which once led to a beach now lead to stone and concrete revetments which protect the base of the wall. Hurricane Carla in 1961 caused \$525,000 damage to this section of the seawall. Storms since Carla have continued to erode beaches in front of this section causing continuing damage to the wall's stone revetment. Above and below water beaches have continued to erode. Flanking is occurring at the end of the seawall creating a threat to a condominium project, city park, county park, state highway, city infrastructure, and the end of the seawall. Highway 3005 is within 400 feet of the shore. The high erosion rate is partly due to the seawall itself. A Class 5 storm could cut the

Island in half since Sweetwater Lake is directly north of this highly eroding beach. Beach renourishment is needed to prevent or reduce storm damage.

c. Phase Three - Gulf Shores - Spanish Grant to Galveston Island State Park

This 7,600-foot section of beach is ranked third on the prioritized list. The erosion rate is high. Beaches and dunes are the only storm surge protection provided within this reach. Four dune breaks provide access to the beach for vehicles. These breaks allow storm surges to penetrate the backshore area. Several homes are currently within the dune system. The dunes are 4 feet high within this zone. Sand fences, Christmas trees, and other systems have been used to capture limited sand supplies. This beach is the center of five sections which are proposed for renourishment.

d. Phase Four - Gulf Shores - Galveston Island State Park to Indian Beach

This section extends 8,200 feet along the Gulf and is ranked fourth on the priority list. The erosion rate is moderate. Three dune breaks exist allowing beach access for vehicles. State Farm Road 3005 is 500 to 700 feet from the Gulf shore along this section of beach. The

City of Jamaica Beach is included in this section of beach. Roadside ditches within Jamaica Beach drain toward the beach creating additional beach erosion. Dune fences and other materials have been used in an attempt to stabilize the dunes. Beach replenishment and dune enhancement are needed to prevent storm damage.

e. Phase Five - Gulf Shores - Sunbird Beach to Pointe San Luis

This 20,500-foot section of beach is rated as a high erosion zone. Beaches and dunes are the only storm surge protection provided within this reach. Four dune breaks provide access to the beach for vehicles. These breaks also allow storm surges to penetrate the backshore area. Dunes are 4 feet high within this zone. The shoreline is within 400 feet of S.H. F.M. 3005 which provides the only emergency evacuation route for the west end of the Island. Erosion along this reach of shore is accelerated because of its proximity to San Luis Pass. Sand fences, Christmas trees, and other systems have been used to capture limited sand supplies. Beach nourishment is proposed for this reach. The proposed nourishment project extends west of Bay Harbour in order to provide protection for F.M. 3005.

2. Backshore Protection

a. Dune Breaks Along the West End of the Island

A total of 15 dune breaks exist which allow vehicle access to the beach. Each break penetrates the existing dune removing its storm surge protection. Dune heights vary at each break from 4 to 6 feet. The majority of the breaks have a paved road leading from F.M. 3005 to the dunes. Each break should be closed to prevent storm surge damage. Alternate parking and dune crossovers could be constructed to provide beach access.

b. Dune Height Along the West End of the Island

Dunes along the west end of the Island have continued to decline in height due to storms and a lack of sand supply. Generally, dunes are higher and wider in undeveloped sections of the Island where the dune system is allowed to receive sediment from each direction. Dune heights vary from 4 to 6 feet. Dunes 10 to 12 feet once existed on the west end of the Island; however, these dune heights have never reestablished after major storms such as Alicia and Carla. A dune enhancement program is needed.

c. Seawolf Park Entry Road (See Exhibit 3)

Since 1953, the Galveston Channel and Texas City Channel side of Pelican Island, leading to Seawolf Park, has continued to erode. The erosion is primarily due to



waves generated from ship traffic and tidal currents. Erosion along the Texas City Channel side of Pelican Island is severe. This contributes to silting in the channel. Stabilization of the banks is needed to protect against further erosion and possible road damage. The City Parks Department is investigating additional park attractions for Seawolf Park and the entry drive must be protected. The park was developed with a federal grant and shore protection would protect this investment.

d. I-45 Feeder Road at Offatt Bayou

The problem is the road is being encroached on by erosion.

e. Groin Modifications

Add "Tees" and "L's" to the end of the groin to hold and trap sand.

f. Breakwaters at the End of the Seawall

Place three 500-foot precast breakwaters to protect against flanking.

C. Zone 3 - Mainland Shore Stabilization (Bay Shores)(See Exhibits 6 and 7, Appendices)

1. Street Termination Along the Bay

Install bulkheading along the bay to provide erosion protection and prevent flanking. Bulkhead should match existing material.

2. Bay Shore Park

The County's Bayshore Park is one of the most severe cases of erosion along the bay shore. The southeast section of the park has an unprotected shore, and erosion of the 10 to 12-foot bluff is encroaching on the park road. The north shore of the park has been protected with rip-rap which appears to have stabilized the northwest park shore. The southeast shore is used by swimmers, boaters, windsurfers, crabbers and fisherman. Remediation recommendation must take into account accessibility to the shore for these activities. The shore consists of mainly clays. Remediation is needed to prevent loss of the road.

3. San Leon - Bayshore Street west of 24th and 21st Streets at the Bay

This street is threatened by severe erosion along the bay. Concrete riprap, old storm pipes, and old bricks have been dumped along the shore to retard the erosion. A severe storm will cause road damage.

4. Bay Shores Where Bulkheads Do Not Exist (Upper Mainland)

The lack of bulkheading along the shore in a limited number of areas has resulted in severe erosion at these locations. These properties are privately owned and the lack of shoreline protection is causing damage to adjacent properties. Shore stabilization is required.

5. Dickinson Bay

The north shore of Dickinson Bay is developed, and in most cases, individual property owners have taken precautions to protect against erosion. Street termination remediation work is needed in some areas to protect adjacent shores. The south shore of Dickinson Bay is undeveloped and erosion appears active near the base of the Texas City levee. Remediation is necessary to protect the levee.

6. Texas City Levee - Dickinson Bay to the Texas City Dike

Erosion is occurring along the base of the levee in several locations. This problem was identified by both the County and the Corps of Engineers. A remediation project was completed in 1990. It included the installation of riprap to protect the levee toe. Some areas along the levee did not receive riprap, and they must be closely monitored. Riprap was placed below grade in the majority of the area where it was installed in position to protect the seawall toe from projected erosion.

7. Texas City Dike to Virginia Point

The north side of the Texas City Dike faces a continuing erosion problem because it faces continual tidal forces as well as storm and ship channel traffic. This side of the dike is exposed to the open bay. Erosion protection

is needed to maintain the stability of the dike. The bay shore along Swan Lake is grassy marshland. Barren islands exist along the bay side of Swan Lake. These islands are eroding due to wave action from the open bay.

8. Virginia Point to the Brazoria County Line (West Bay)

This section of the bay has some of the bay's longest stretches of marshland which are being subjected to continuing subsidence and erosion along the intracoastal waterway. These marshlands must be protected from the wave action of the open bay and boat traffic along the intracoastal waterway.

## **VI. REVIEW AND IDENTIFY ALTERNATIVE TECHNOLOGIES**

Coastal engineering problems may be classified into four general categories: (1) shoreline stabilization, (2) backshore protection (from waves and surge), (3) inlet stabilization, and (4) harbor protection. Coastal problem areas may be placed under one or more of these categories. Once the problem area was categorized into a particular classification, various design solutions available within each category were reviewed. The following diagram shows shoreline protective alternatives for the four general categories.

A. ALTERNATIVES CONSIDERED

**CLASSIFICATION OF COASTAL ENGINEERING PROBLEMS**

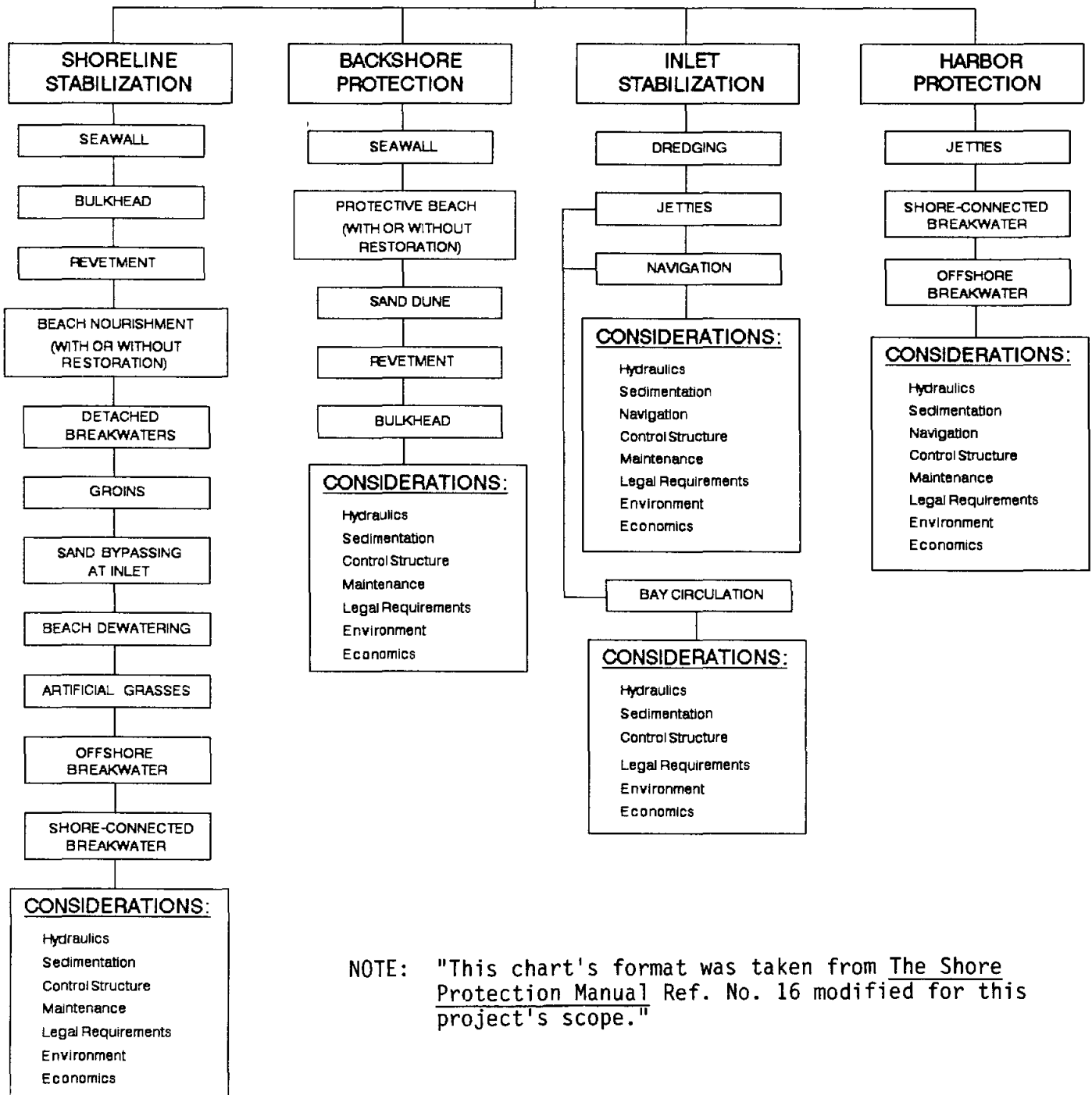

NOTE: "This chart's format was taken from The Shore Protection Manual Ref. No. 16 modified for this project's scope."

The problem areas identified along Galveston County's shores were classified and alternative design solutions were reviewed to identify the solution which provided the most beneficial long range solution.

**B. Alternatives Selected**

**Zone 1 - Bolivar Peninsula (See Zone 1 Exhibit 4, Section VII.)**

**1. Shore Stabilization**

**Gulf shore erosion: beach replenishment (see Bolivar beach profile exhibits)**

- a. **Phase One (High Island to Rollover Pass)**
- b. **Phase Two (Rollover Pass to Caplen)**
- c. **Phase Three (Crystal Beach)**
- d. **Phase Four (Crystal Beach)**
- e. **Phase Five (Port Bolivar)**
- f. **Phase Six (Jetties and Bulkhead at Rollover Pass)**
- g. **Phase Seven - Sievers Cove/Stingray Cove**  
**Revetment along the base each side of the opening**  
**(request Corps to investigate).**

2. **Inlet Stabilization**

a. **Rollover Bay**

Dredge the bay near the intercoastal; place material on the beaches at Rollover (request Corps to investigate).

3. **Backshore Protection**

a. **Dune Breaks Along the Peninsula (See Dune Protection Plan Exhibit)**

Fifty dune breaks exist along the peninsula. Fill, grade, pave, and landscape each opening.

b. **Dune Height**

Elevate the existing dunes for storm protection.

**Zone 2 - Galveston Island** (See Zone 2 Exhibit 5, Section VII.)

1. **Shore Stabilization**

**Gulf Shore Erosion: Beach Replenishment (See Groin and West Beach Exhibits)**

a. **Phase One (Groin Field - 10th Street to 61st Street)**

b. **Phase Two (61st Street to 8 Mile Road)**

c. **Phase Three (Spanish Grant to Galveston Island State Park)**



- d. **Phase Four (Galveston Island State Park to Indian Beach)**
- e. **Phase Five (Sunbird Beach to Pointe San Luis)**
- f. **Dune Breaks Along the Island**  
Eighteen dune breaks exist along the Island. Fill, grade, pave and landscape each opening.
- g. **Dune Height Along the Island**  
Elevate the existing dunes for storm protection.

2. **Backshore Protection**

- a. **Seawolf Park Entry Road**  
Riprap to prevent continuous erosion along the navigation channels (request work to be accomplished by the Corps).
- b. **Port Industrial Boulevard**  
Protect the shore near the road. Place, fill and riprap along the shore to protect the road. (City/County/State)
- c. **Travel Air/Crash Basin**  
Long term - raise the road; short term - fill and riprap of banks. (City)

- d. **I-45 Feeder - Offatt Bayou**  
Long term - raise the road; short term - fill and riprap of banks
  
- e. **Groin Modifications**  
Add "Tees" and "L's" to the end of the groin to hold and trap sand. ( See Chapter 4, page 65 of Texas A&M's "Shoreline Protection and Implementation Options for Galveston County, Texas")
  
- f. **Breakwaters at the End of the Seawall**  
Place three 500-foot precast breakwaters to protect against flanking.

**Zone 3 - Mainland**

- 1. **Shore Stabilization (Bay Shores)**
  - a. **Street Termination Along the Bay**  
Install bulkheading along the bay to provide erosion protection and prevent flanking. Bulkhead should match existing material.

**VII. ALTERNATIVE PHASES, COST ESTIMATES AND SCHEMATICS**

**A. Zone 1 - Bolivar Peninsula (See Zone 1 Exhibit 4, Appendices)**

**1. Shore Stabilization**

Gulf shore erosion: beach replenishment (See Bolivar Beach Profile Exhibit 8, Section VII.). The estimated cubic yard of sand needed to renourish Bolivar's beaches is 32.22 cubic yards per linear foot. Estimated dredging cost equals \$3.50/c.y. Each time a pump booster station is added, the cost increases approximately \$1.00/c.y. A pump station is needed every 10,000 feet.

**a. Phase One (High Island to Rollover Pass)**

Sand source - Gulf shoal; 4 pump stations required.

44,500' @ \$250.00/L.F. = \$11,125,000

Because of the length and cost of this phase, we suggest the project be divided into three sections as illustrated on Exhibit 8.

**b. Phase Two (Rollover Pass to Caplen)**

Sand source - Gulf shoal; 2 pump stations required.

14,000' @ \$200.00/L.F. = \$ 2,800,000

**c. Phase Three (Crystal Beach)**

Sand source - Gulf shoal or Galveston Channel; 4 pump stations required.

28,000' @ \$250.00/L.F. = \$ 7,000,000

d. Phase Four (Crystal Beach West)

Sand source - Gulf shoal or Galveston Channel; 4 pump stations required.

10,000' @ \$250.00/L.F. = \$ 2,500,000

e. Phase Five (Highway 87 at Fort Travis)

Sand source - Galveston entry channel; 1 pump station required.

6,000' @ \$150.00/L.F. = \$ 900,000

f. Phase Six (Jetties and Bulkhead at Rollover, See Exhibit 10, Section VII.E)

1,600 L.F. @ \$4,000.00/L.F. = \$ 6,400,000

150 L.F. @ \$200.00/L.F. = \$ 30,000

g. Phase Seven - Sievers Cove/Stingray Cove

Revetment along the base each side of the opening (request Corps to investigate).

2. Inlet Stabilization

a. Rollover Bay

Dredge the bay near the intercoastal; place material on the beaches at Rollover (request the Corps investigate dredge cost saving alternatives and better resource management for storm protection).

3. Backshore Protection

a. Dune Breaks Along the Peninsula (See Dune Protection Plan Exhibit 9, Section VII.)

Fifty dune breaks exist along the peninsula. To fill, grade, pave, and landscape each of these openings would cost approximately \$10,000 each.

50 x \$10,000 - \$500,000.00 Total

b. Drainage Outfalls

Drainage outfalls along beach shall be rerouted to outfall into bay or intracoastal canal. Cost has not been determined.

c. Dune Height Along the Peninsula

Rebuild and enhance the peninsula's dune system. Request that the Corps allow mining of their dredge disposal sites for dune enhancement purposes. Allow individuals to use the material to rebuild dunes along the peninsula. The material would be free. Cost of hauling and installing would be the responsibility of the individual property owner or neighborhood association. Loading cost could be provided by the county. A small fee could be assessed by the County to cover operating costs only. A program such as this could extend the life of the dredge site and provide extremely needed dune enhancement.

**B. Zone 2 - Galveston Island (See Zone 2 Exhibit 5, Appendices)**

**1. Shore Stabilization**

**Gulf Shore Erosion: Beach Replenishment (See Groin and West Beach Exhibits 11 and 12, Section VII.)**

**a. Phase One (Groin Field)**

**Sand source - big reef; 4 pump stations.**

**20,500' @ \$330.00/L.F. = \$ 6,765,000**

**b. Phase Two (61st Street to 8 Mile Road)**

**Sand source - big reef; 6 pump stations.**

**22,000' @ \$250.00/L.F. = \$ 5,500,000**

**c. Phase Three (Spanish Grant to Galveston Island State Park)**

**Sand source - San Luis Pass shoal; 7 pump stations.**

**15,000' @ \$340.00/L.F. = \$ 5,100,000**

**d. Phase Four (Galveston Island State Park to Indian Beach)**

**Sand source - San Luis Pass shoal.**

**15,000' @ \$250.00/L.F. = \$ 3,750,000**

**e. Phase Five (Sunbird Beach to Pointe San Luis)**

**20,500' @ \$200.00/L.F. = \$ 4,100,000**

**2. Backshore Protection**

**a. Travel Air/Crash Basin**

**Long term - raise the road; short term - riprap banks of road.**

- a. I-45 Feeder - Offatt Bayou  
Highway Department - long term - raise the feeder; short term - riprap banks
- b. Port Industrial Boulevard  
City/County/State - raise road - riprap banks
- c. Seawolf Park Entry Road  
Request the Corps to riprap to prevent shoaling into the navigation channel.
- e. Dune Breaks Along the Island (See Dune Protection Plan Exhibit 9, Appendices)  
Eighteen dune breaks exist along the island. To fill, grade, pave and landscape each of these openings would cost approximately \$10,000 each.  
 $18 \times 10,000 = \$180,000.00$  - City and Parks Board
- f. Dune Height Along the Island (See Exhibit 12, Appendices)  
Rebuild and enhance the island's dune system. Request that the Corps allow mining of their dredge disposal sites for dune enhancement purposes. Allow individuals to use the material to rebuild dunes along the peninsula. The material would be free. Cost of hauling and installing would be the responsibility of the individual property owner or neighborhood association. Loading cost could be provided by the county. A small

fee could be assessed by the County to cover operating costs only.

h. Groin Modifications (See Exhibit 13, Appendices)

Add "Tees" and "L's" to the end of the groins to hold and attract sediment.

$\$4,000/\text{L.F.} \times 500 \text{ L.F.} = \$2,000,000.00$  each

i. Breakwaters

Install prefabricated breakwaters to prevent flanking at the end of the Galveston seawall.

$3 \times \$650/\text{L.F.} \times 500 \text{ L.F.} = \$975,000.00$

Breakwaters at San Luis Pass

$3 \times \$650/\text{L.F.} \times 500 \text{ L.F.} = \$975,000.00$

C. Zone 3 - Mainland

1. Shore Stabilization

a. Street Termination at the Bay (See Exhibit 14, Appendices)

Backslope drain extensions, bulkheading, riprap at outfall, and backfill and grading \$20,000 each.

b. Bayshore Park (See Exhibit 15, Section VII.)

Create a perched beach with a bag wall or Mac blocks installed to stabilize the shore, cutting and relocation of fill soil along the shore and planting and seeding along the shore.



C. Zone 3 - Mainland (continued)

c. Cost Estimate

<u>Description</u>	<u>Unit</u>	<u>Quantity</u>	<u>Amount</u>
Bag Wall	\$75.00 L.F.	1,400 Ft.	\$105,000
Excavation	\$ 4.00 C.Y.	3,800 C.Y.	\$ 15,000
Sand	\$ 6.50 C.Y.	2,500 C.Y.	\$ 16,250
Planting	\$20,000 L.S.	1	<u>\$ 20,000</u>
TOTAL			\$156,250

## **VIII. FUNDING PROGRAMS AND OPTIONS**

The intent of this section is to investigate coastal funding alternatives which exist today, tomorrow and could possibly be available in the future for federal, state, and county governments. Arranging financial funding for coastal projects requires consideration of three fundamental components:

1. Choosing tools to access revenues;
2. Establishing mechanisms to manage the flow of funds; and
3. Creating the institutions for financial management.

The most common forms of securing revenues include taxes, user fees, intergovernmental grants, and debt difference. Taxes are suited to finance different types of activities. Property and sales taxes finance activities which benefit the entire community, whereas user fees are appropriate to raise funds from select groups of beneficiaries. The method chosen to access revenue, manage those revenues, and create the institution to manage those funds must be selected and established by the local, city, county, or state agencies. The methodology selected depends on the specific programs identified in each location. Analysis must be made to identify the program which will work best for a particular location. The following federal, state, and county funding section will illustrate the options available today and possibly be available in the future.

**A. Federal Funding**

The following federal agencies have regulatory or research responsibilities for the Gulf coast:

1. **Federal Emergency Management Agency** (independent federal organization) administers the National Flood Insurance Program (NFIP), which provides federally subsidized insurance protection in many coastal and flood-prone areas of the United States. Making NFIP self-supporting and eliminating federal subsidies are major goals.
2. **National Oceanic and Atmospheric Administration** (U.S. Department of Commerce) conducts studies of wetlands and coastal habitats that support marine resources; prepares nautical charts and geodetic surveys of coastal areas; monitors storm activities; operates an environmental satellite system; administers a grants program for marine research.
3. **National Park Service**(U.S. Department of the Interior) administers an extensive system of public lands, including lakeshores and seashores, set aside for the protection of natural environments, the preservation of historic properties, and the education and enjoyment of our citizens.
4. **Natural Science Foundation** (independent federal organization) supports fundamental, long-term coastal research in the earth

sciences and in engineering fields. This support is made through grants, contracts, and agreements awarded to universities and other research groups.

5. U.S. Army Corps of Engineers (U.S. Department of Defense) conducts applied research and development for design, construction, operation, and maintenance activities related to harbors, navigational waterways, and coastal protection. The Corps also administers laws for protecting navigable waters and related coastal resources such as wetlands.
6. U.S. Coast Guard (U.S. Department of Transportation) is responsible for enforcing laws related to the protection of marine environments; provides a national response center that investigates oil and chemical spills, initiates penalty actions, and monitors and coordinates cleanups.
7. U.S. Environmental Protection Agency (independent federal agency) funds and conducts contaminant studies and related coastal research; regulates the discharge of coastal pollutants and the disposal of dredged sediments.
8. U.S. Fish and Wildlife Service (U.S. Department of the Interior) manages extensive coastal lands as wildlife preserves; conducts research on coastal wetlands, fish and wildlife populations, and changes in habitat.

9. U.S. Geological Survey (U.S. Department of the Interior) conducts research on the geologic framework of coasts and on sediment-transport processes; collects and analyzes hydrologic data; makes topographic, geologic, and hydrologic maps of coastal areas; investigates ancient and modern coastal environments.
  
10. U.S. Minerals Management Service (U.S. Department of the Interior) studies the potential impact of offshore activities, including the placement and construction of petroleum pipelines, on coastal wetlands and resources; funds research through State geoscience agencies for identifying mineral resources in the coastal zone.

The Office of Management and Budget each year updates its catalog of Federal and Domestic Assistance. The following pages are excerpts from the 1991 Addition. Many of these programs are currently being utilized by both state and local government.

Two of these agencies currently manage programs created by federal legislation which could provide funding assistance to Galveston County. These agencies are the Federal Emergency Management Agency (FEMA), and the U.S. Army Corps of Engineers.

**Federal Emergency Management Agency**

Legislation was introduced in 1991 that would revise the National Flood Insurance Program. The legislation is H.R. 1236, The National Flood Insurance Mitigation and Erosion Management Act of 1991. Section 402 of

this act establishes a Mitigation Assistance Program which allows the director to make grants to states, communities participating in the national insurance program, and any individual. Certain qualifications must be met in order to qualify for the grant funds. A copy of the draft legislation is attached in the Appendix. Activities eligible for mitigation are: elevation of structures, relocation of structures, flood-proofing of structures, provision of technical assistance by states to communities, and acquisition by states and communities of property. Grants are limited to \$5 million for each state or community and \$250,000 to an individual. The legislation also establishes a mitigation transition pilot program. Grants can be made to states, communities and individuals to carry out eligible mitigation activities. Each year \$1,250,000 will be available to carry out this pilot program.

The mitigation program of H.R. 1236, if passed and implemented, could be extremely beneficial to Galveston County's coastal and inland areas which have repeat flood claims. While the enactment of this legislation will be beneficial, sections of the legislation could be viewed as restrictive. Minimum land use restriction will be mandatory within established 10, 30 and 60 year erosion zones. Communities designated as erosion-prone would be required to incorporate setbacks in their zoning laws to continue participation in the National Flood Insurance Program. The following activities would be prohibited: relocation, new construction or substantial improvement of any structure consisting of 1 to 4 dwelling units seaward of the 30-year erosion setback; and new

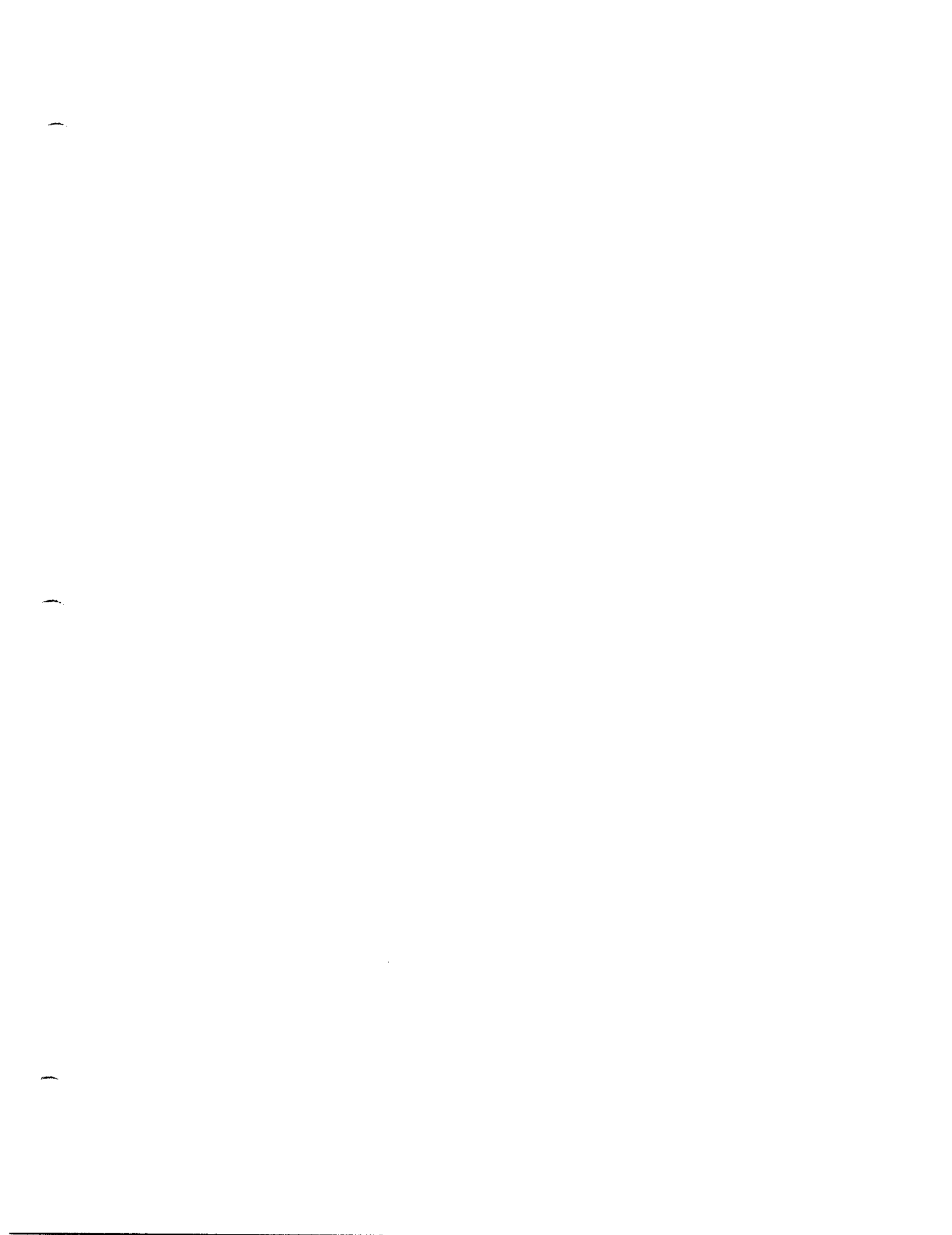

construction or substantial improvement of any structure consisting of 1 to 4 dwelling units that is not readily moveable located seaward of the 60-year erosion setback. The legislation also authorizes FEMA to provide erosion mitigation assistance for structures that are relocated or demolished. The intent of the legislation is to use the Federal Emergency Management Agency (FEMA) to implement and enforce the National Coastal Management Program through the existing National Flood Insurance Program (NFIP) and make the NFIP actuarially sound to cover all claims out of premium income and thereby reduce future dependence of federal tax money to subsidize the program. (Note: FEMA legislation the 50 year setback per established yearly erosion rate did not pass congress.)

FEMA has not yet exercised its legislative authority to identify flood-related erosion zones in coastal areas. It is extremely important that cities and counties participating in the National Flood Insurance Program play a part in the establishment of their 10, 30 and 60 year setback lines. Varying erosion rates will produce a varying setback line. Stable beaches or accreting beaches will have stable or decreasing setback restriction on updated FEMA maps. The NFIP was revised in 1986 with the introduction of the Upton Jones Amendments, Section 544 of the Housing and Community Development of 1987. This amendment was the first time insurance benefits could be received prior to actual damage or loss occurring. The Upton-Jones Amendment is a tentative step in the direction of a strategy that emphasizes retreat from eroding shorelines. This represents a means of reducing NFIP loss payments and promoting public coastal management objectives. Upton



Jones, to date, has had a modest influence on the owners of property at risk with only 266 claims filed as of August, 1989. It is felt that this is due to FEMA's definition of the "zone of imminent collapse" which reads as follows: ". . . as area subject to erosion adjacent to the shoreline of an ocean, bay or lake and within a distance equal to 10 feet plus 5 times the average annual long term erosion rate for the site, measured from the reference feature." The zone of imminent collapse is too narrow and restrictive to accomplish the intent of the Upton Jones Amendment. The narrow zone leaves little margin of error for miscalculation of the Average Annual Erosion rate and mislocation of a reference feature. A larger margin of error is needed to afford more time to relocate threatened structures. H.R. 1236's establishment of 10, 30 and 60 year erosion lines and restriction of development activity in those zones will in effect broaden the zone of imminent collapse. FEMA is also continuing to update their Flood Insurance Rate Maps. In coastal areas, the update includes wave height analysis for coastal zones. The regional office in Denton recently updated the wave height analysis for the Bolivar Peninsula and the base flood elevation increased. An update in the FEMA maps for Galveston Island is needed. In addition, sections along the Bolivar Peninsula's undeveloped areas have been declared restrictive zones. Restrictive zones cannot participate in any federal funding assistance programs involving insurance, water, sewer, roads, etc. Any development or reconstruction within a restrictive zone must be paid by the owner's or developers in full.

### **Corps of Engineers**

Congress has provided general authority to the Corps of Engineers in several laws. The Secretary of the Army and the Chief of Engineers are authorized to plan, design and construct certain types of water resource improvements without specific Congressional authority.

The continuing authority's program consists of:

1. Small flood control projects, Section 205 Flood Control Act of 1948, as amended (33 U.S.C. 701s).
2. Clearing and desnagging, Section 3 River & Harbor Act of 1945, as amended (33 U.S.C. 701g).
3. Emergency streambank and shoreline protection of public works and nonprofit public services, Section 14, Flood Control Act of 1946, as amended (33 U.S.C. 701r).
4. Small navigation projects, Section 107, River and Harbor Act of 1960, as amended (33 U.S.C. 577).
5. Snagging and clearing for navigation, Section 3, River and Harbor Act of 1945 (33 U.S.C. 603a).
6. Small beach erosion control project, Section 3, River and Harbor Act of 1962, as amended (33 U.S.C. 426g).
7. Mitigation of shore damages attributable to navigation projects, Section III, River and Harbor Act of 1968 (33 U.S.C. 426i).

Each continuing authority program must follow specific program policies. These policies set certain limitations and guidelines which are followed by the Corps in administering these programs. Statutes which could be utilized by the county and city are as follows:

**(33 U.S.C. 701s) Small flood control projects; appropriations; amount limitation for single locality; conditions**

"The Secretary of the Army is authorized to allot from any appropriations heretofore or hereafter made for flood control, not to exceed \$40,000,000 for any one fiscal year, for the construction of small projects for flood control and related purposes not specifically authorized by Congress, which come within the provisions of section 701a of this title, when in the opinion of the Chief of Engineers such work is advisable. The amount allotted for a project shall be sufficient to complete Federal participation in the project. Not more than \$5,000,000 shall be allotted under this section for a project at any single locality. The provisions of local cooperation specified in section 701c of this title shall apply. The work shall be complete in itself and not commit the United States to any additional improvement to insure its successful operation, except as may result from the normal procedure applying to projects authorized after submission of preliminary examination and survey reports."

**(33 U.S.C. 701r) Emergency streambank and shoreline protection of public work and nonprofit public services (protection of highways, bridge approaches, public works, and non profit public services).**

"The Secretary of the Army is authorized to allot from any appropriations heretofore or hereafter made for flood control, not to exceed \$12,500,000 per year, for the

construction, repair, restoration, and modification of emergency streambank and shoreline protection works to prevent damage to highways, bridge approaches, and public works, churches, hospitals, schools, and other nonprofit public services, when in the opinion of the Chief of Engineers such work is advisable: *Provided*, That not more than \$500,000 shall be allotted for this purpose at any single locality from the appropriations for any one fiscal year."

**(33 U.S.C. 426g) Small beach erosion control project**

"The Secretary of the Army is authorized to undertake construction of small shore and beach restoration and protection projects not specifically authorized by Congress, which otherwise comply with section 426e of this title, when he finds that such work is advisable, and he is further authorized to allot from any appropriations hereafter made for civil works, not to exceed \$30,000,000 for any one fiscal year for the Federal share of the costs of construction of such projects: *Provided*, That not more than \$2,000,000 shall be allotted for this purpose for any single project and the total amount allotted shall be sufficient to complete the Federal participation in the project under this section including periodic nourishment as provided for under section 426e(c) of this title: *Provided further*, That the provisions of local

cooperation specified in section 426e of this title shall apply: *And provided further,* That the work shall be complete in itself and shall not commit the United States to any additional improvement to insure its successful operation, except for participation in periodic beach nourishment in accordance with section 426e(c) of this title, and as may result from the normal procedure applying to projects authorized after submission of survey reports."

The referred Section 426e is as follows:

**(33 U.S.C. 426e) Federal aid in protection of shores**

**(a) Declaration of policy**

"With the purpose of preventing damage to the shores of the United States, its Territories and possessions and promoting and encouraging the healthful recreation of the people, it is declared to be the policy of the United States, subject to the following provisions of sections 426e to 426h of this title to assist in the construction, but not the maintenance, of works for the restoration and protection against erosion, by waves and currents, of the shores of the United States, its Territories and possessions.

**(b) Federal contribution; maximum amount; exceptions**

The Federal contribution in the case of any project referred to in subsection (a) of this section shall not exceed one-half of the cost of the project, and the remainder shall be paid by the State, municipality, or other political subdivision in which the project is located, except that (1) the costs allocated to the restoration and protection of Federal property shall be borne fully by the Federal Government, (2) Federal participation in the cost of a project for restoration and protection of State, county, and other publicly owned shore parks and conservation areas may be, in the discretion of the Chief of Engineers, not more than 70 per centum of the total cost exclusive of land costs, when such areas: include a zone which excludes permanent human habitation; include but are not limited to recreational beaches; satisfy adequate criteria for conservation and development of the natural resources of the environment; extend landward a sufficient distance to include, where appropriate, protective dunes, bluffs, or other natural features which serve to protect the uplands from damage; and provide essentially full park facilities for appropriate public use, all of which shall meet with the approval of the Chief of Engineers, and (3) Federal participation in the cost of a project providing hurricane protection may be, in the discretion of the Secretary of

the Army, acting through the Chief of Engineers, nor more than 70 per centum of the total cost exclusive of land costs.

**(c) Periodic beach nourishment; "construction" defined**

"When in the opinion of the Chief of Engineers the most suitable and economical remedial measures would be provided by periodic beach nourishment, the term "construction" may be construed for the purposes of sections 426e to 426h of this title to include the deposit of sand fill at suitable intervals of time to furnish sand supply to project shores for a length of time specified by the Chief of Engineers.

**(d) Shores other than public**

Shores other than public will be eligible for Federal assistance if there is benefit such as that arising from public use or from the protection of nearby public property or if the benefits to those shores are incidental to the project, and the Federal contribution to the project shall be adjusted in accordance with the degree of such benefits.

**(e) Authorized plans**

No Federal contributions shall be made with respect to a project under sections 426e to 426h of this title unless the plan therefor shall have been specifically adopted and authorized by Congress after investigation and study by the Coastal Engineering Research Center under the provisions of section 426 of this title as amended and supplemented, or, in the case of a small project under section 426g of this title, unless the plan therefor has been approved by the Chief of Engineers.

**(33 U.S.C. 426f) Payments to States, etc.**

The Secretary of the Army is authorized to reimburse local interests for work done by them, after initiation of the survey studies which form the basis for the project, on authorized projects which individually do not exceed \$1,000,000 in total cost: *Provided*, That the work which may have been done on the projects is approved by the Chief of Engineers as being in accordance with the authorized projects: *Provided further*, That such reimbursement shall be subject to appropriations applicable thereto or funds available therefor and shall not take precedence over other pending projects of higher priority for improvements."



**(33 U.S.C. 426i) Shore damage prevention or mitigation**

"The Secretary of the Army is authorized to investigate, study, plan, and implement structural and nonstructural measures for the prevention or mitigation of shore damages attributable to Federal navigation works, if a nonFederal public body agrees to operate and maintain such measures, and, in the case of interests in real property acquired in conjunction with nonstructural measures, to operate and maintain the property for public purposes in accordance with regulations prescribed by the Secretary. The costs of implementing measures under this section shall be cost-shared in the same proportion as the cost-sharing provisions applicable to the project causing the shore damage. No such project shall be initiated without specific authorization by Congress if the federal cost exceeds \$2,000,000."

The continuing Authority programs outlined above could be utilized by Galveston County or the City of Galveston. For instance, the city could utilize the Small Flood Control Project Program to implement a storm surge damage reduction program for the west end of Galveston Island and the county could implement the same program for the Bolivar Peninsula. Dune breaks now allow tidal surges to enter the back shore area. The cost associated with correcting the dune breaks on Galveston Island and the Bolivar Peninsula fall well within the federal project limitation for this program.

The Small Flood Control Project Program could also be utilized by Galveston and the county to prevent future flood damage caused by erosion and unstable shores at the end of the seawall. This particular area includes federal, state, county, and city property. Each entity's property will be damaged in a hurricane. The end of the seawall would also qualify under other Federal assistance programs which will be mentioned later.

The Emergency Streambank and Shoreline Protection of public works and nonprofit public services (section 14) program could be utilized to correct and stabilize the bay shore along the north side of Seawolf Park on Pelican Island where the access roads are extremely close to the bay shores. A return of the existing revetment would prevent continuing flanking and road damage. The Seawolf Park was developed with Federal grant funds. It appears this project meets the qualifying criteria for this program.

The Small Beach Erosion Control Program (section 103) could be utilized to fund the numerous beach erosion projects within the county. These projects include: Rollover Pass Beach replenishment project, the ferry landing (Hwy. 87) protection plan, the groin field beach renourishment plan and renourishment of the beach at the west end of the seawall. Restoring and stabilizing of these beaches would greatly enhance the storm surge protection capabilities of these beaches. These projects would prevent increases in future losses.

The Secretary of the Army is also authorized under other legislation to assist States and other public entities in developing and enhancing coastal areas. This program includes (33 U.S.C. 426j) placement on State beaches of sand dredged in constructing and maintaining navigation inlets and channels adjacent to such beaches.

"The Secretary of the Army, acting through the Chief of Engineers, is authorized upon request of the State, to place on the beaches of such State beach-quality sand which has been dredged in constructing and maintaining navigation inlets and channels adjacent to such beaches, if the Secretary deems such action to be in the public interest and upon payment by such State of 50 percent of the increased cost thereof above the cost required for alternative methods of disposing of such sand. In carrying out this section, the Secretary shall give consideration to the State's schedule for providing its share of funds for placing such sand on the beaches of such State and shall, to the maximum extent practicable, accommodate such schedule."

The Water Resources Development Act of 1990 includes several new sections (306, 309 and 319) which could affect Federal participation in shoreline projects.

Section 306 requires the Secretary to include environmental protection as one of the primary missions of the Corps of Engineers in planning, designing, constructing, operating, and maintaining water resources projects. Subsection (d) establishes a Wetland Restoration and Enhancement Demonstration Program. The secretary is to report to Congress on what opportunities exist to enhance the nation's wetlands. Each District Corps office with jurisdiction over wetlands will assist in developing the report.

Section 309 reads as follows:

**"SEC. 309. SHORELINE PROTECTION.**

Not later than 1 year after date of the enactment of this Act, the Secretary shall transmit to Congress a report on the advisability of not participating in the planning, implementation, or maintenance of any beach stabilization or renourishment project involving Federal funds unless the State in which the proposed project will be located has established or committed to establish a beach front management program that includes:

- (1) restrictions on new development seaward of an erosion setback line (based on preproject beach size) of at least 30 times the annual erosion rate;
- (2) restrictions on construction of new structural stabilization projects, such as seawalls and groins, and their reconstruction if damaged by 50 percent or more;

- (3) provisions for the relocation of structures in erosion-prone areas;
- (4) provisions to assure public access to beaches stabilized or renourished with Federal funds after January 1, 1991; and
- (5) such other provisions as the Secretary may prescribe by regulation to prevent hazardous or environmentally damaging shoreline development."

The report to Congress will be available to the public by the first quarter of 1992. It is presently being reviewed internally by the Corps. A recommendation to proceed with these funding restrictions could delay funding to Texas since the state's management plan is not as restrictive as Section 309. Recommendations in this report should be closely monitored by the the state and local officials. In addition, similar legislation has been introduced as a revision to the National Flood Insurance Program (HR 1236) which will be discussed later.

Section 319 of the 1990 Water Resource Act revises Section 22 of the 1974 Water Resource Development Act (42 U.S.C. 1962d-16). A phased-in fee program is established which allows the Corps to recover a maximum of 50% of the total cost of providing planning assistance. The statutes read as follows:

**1962d-16. Comprehensive plans for development, utilization, and conservation of water and related resources**

### **Federal and State Cooperation**

The Secretary of the Army, acting through the Chief of Engineers, is authorized to cooperate with any State in the preparation of comprehensive plans for the development, utilization, and conservation of the water and related resources of drainage basins located within the boundaries of such State and to submit to Congress reports and recommendations with respect to appropriate Federal participation in carrying out such plans.

#### **(b) Authorization of appropriations; general and State limitation**

There is authorized to be appropriated not to exceed \$6,000,000 annually to carry out the provisions of this section except that not more than \$300,000 shall be expended in any one year in any one State.

#### **(c) "State" defined**

For the purposes of this section, the term "State" means the several States of the United States, the Commonwealth of Puerto Rico, Guam, American Samoa, the Virgin Islands, the Commonwealth of the Northern Marianas, and the Trust Territory of the Pacific Islands.

Section 319 FEES FOR DEVELOPMENT OF STATE WATER PLANS

Section 22 of the Water Resources Development Act of 1974 (42 U.S.C. 1962dd-16), is amended -

(1) by redesignating subsections (b) and (c), and any reference thereto, as subsections (c) and (d), respectively; and

(2) by inserting after subsection (a) the following new subsection:

"(b) FEES -

"(1) ESTABLISHMENT AND COLLECTION - For the purpose of recovering 50 percent of the total cost of providing assistance pursuant to this section, the Secretary of the Army is authorized to establish appropriate fees, as determined by the Secretary, and to collect such fees from States and other non-Federal public bodies to whom assistance is provided under this section.

"(2) PHASE-IN - The Secretary shall phase in the cost sharing program under this subsection by recovering -

"(A) approximately 10 percent of the total cost of providing assistance in fiscal year 1991;

"(B) approximately 30 percent of the total cost in fiscal year 1992; and

"(C) approximately 50 percent of the total cost in fiscal year 1993 and each succeeding fiscal year.

"(3) DEPOSIT AND USE - Fees collected under this subsection shall be deposited into the account in the Treasury of the United States entitled, 'Contributions and Advances, Rivers and Harbors, Corps of Engineers (8862)' and shall be available until expended to carry out this section."

**B. State Funding**

The State of Texas is in the infant stages of developing its Coastal Management Plan. Senate Bill 1571 introduced by Chet Brooks in 1989 directed the General Land Office to develop a Coastal Management Plan for the state. Recommendations for the Texas Coastal Management Plan were presented to the Governor and the 72nd Legislative Session in January, 1991. Coastal Management Bills H.B. 1622 and H.B. 1623 were introduced by Representative Mike Martin in 1991. H.B. 1622 dealt with wetland issues along the Texas coast. House Bill 1623 dealt with beach erosion, dunes and beach access. These bills were signed by Governor Ann Richards in 1991. Public law developed from the bills were submitted to the National Oceanic and Atmospheric Administration (NOAA) for approval as part of the Texas Coastal Management Program.

The state has also applied and received a grant for \$200,000 for further development of the state's Coastal Zone Management Program (CZMP) from NOAA's Office of Ocean and Coastal Resource Management. Acceptance of



the state's CZMP is still pending. If the state's CZMP is accepted by NOAA, Texas could receive one to two million dollars in federal funds for Coastal Zone Management Projects. Coastal counties which qualify (meet the minimum federal guidelines) could receive some federal assistance.

Typically, the federal funds are matched by state and local funds to develop comprehensive projects. Unfortunately, the state has not identified a source of revenue to generate the needed state matching funds.

The only state program available for shoreline flood protection is administered by the Texas Water Development Board (TWDB). TWDB programs have loan funds available for planning, design, and implementation. The Texas Water Development Fund Program has low interest loan funds available. Recent legislation was passed granting the Board the ability to fund beach nourishment projects through the flood control account of the Texas Water Development Fund. This has caused delays in the full utilization of these programs. The Texas Water Development Board's Research and Planning Program, however, offers planning assistance grants for flood control projects. This funding method was used for this planning effort. Grants by the Board for flood protection planning are limited to 50% of the total cost of the project, except that the Board may provide up to 75% of the total cost to political subdivisions which have unemployment rates exceeding the state average by 50% or more, and which have a per capita income which is 65% or less of the state average for the last reporting period available. This means local entities must contribute 50% of the total planning cost. As another part of the flood

protection planning grant program, the non-Federal sponsor of a cost-shared feasibility study, by the Corps, related to flood protection planning may apply to the Board to obtain grant funds for a portion of the 50% local share of the cost. Typically, the Board share is 50% of the local share or 25% of the total study cost. This agreement by the Corps and TWDB is an attempt to solve flooding problems at reduced cost to the local entities. Several entities across the state have taken advantage of this program and have active cooperative planning programs underway.

If the planning efforts provide feasible solutions which meets federal guidelines, the Corps will apply to Congress for federal assistance. The problem with the federal process is the time it takes to conceive, plan, and initiate a project is typically 6 to 12 years. This is why the state's acceptance into the federal CZM program is essential. It is also the reason Texas must develop a more attractive funding source to supplement local funds. A large portion of the state is not within the coastal zone and inland counties tend to not easily identify with coastal problems. Requesting citizens in El Paso to approve assistance in funding a beach nourishment project in Galveston County is difficult. The revenue stream generated by the state should mostly come from the coastal zone where people have an interest and investment. Grants, debts, private capital and tax increment financing have all been used by other states, and these options are discussed under local funding.

C. Local (City or County) Funding

City and county governments have several revenue generating options available for shoreline flood protection and restoration projects. These options are taxes, user fees, intergovernmental grants, debts, private capital and tax increment financing. Tax options can be generated through the passage of special legislation or under existing legislation. There are three general categories of taxes: income, property, and consumption (sales). Income taxes are not considered appropriate for shoreline flood protection projects. Property taxes and consumption taxes are better ways of funding projects which provide regional benefits. Coastal flood control projects are region problems. Property taxes have been used to fund regional drainage projects throughout Texas. Galveston County could implement a county-wide drainage tax, based on property evaluation, which could finance flood control projects throughout the county. Special Improvement Districts could be established for the specific purpose of implementing shoreline flood control projects. The establishment of small districts or authorities allow the local government to have direct control over proposed projects; however, small districts or authorities typically cannot generate enough revenue to implement often needed large projects. Preferably, districts or authorities would be established on a county-wide basis to provide a broader tax base to implement larger projects. A broader tax base could decrease the individual tax burden.

Tourist attraction areas often use sales taxes on lodging, meals and entertainment to equitably generate revenues to finance public facilities. The tax is typically sized to accommodate the seasonal

nature of the tourist business.

Consumption taxes have traditionally singled out certain commodities for special taxation such as gas, cigarettes and liquor. These commodity taxes provide a narrow tax base that can target beneficiaries of specific products or services.

Fees for public services are intended to establish a direct link between demand for services and the cost to provide them. Fees are the most equitable means of matching program costs and program beneficiaries. Fees must be set to fully cover the cost of service.

Typically, fees are calculated on use (user fees) or on the impact (impact fees) imposed on the system. User fees are currently in existence by both the county and city through parking fees charged at beach park facilities. This program could be expanded to cover costs associated with various improvements. Impact fees transfer the cost of service improvements directly back to the landowner who received the benefit. Typically, impact fees are collected in a lump sum at the beginning of a project.

Intergovernmental grants are simply the transfer of fees or taxes collected at a higher level of government to a lower level of government. If the Texas Coastal Management Plan is accepted by NOAA, the state will be able to receive federal grant funds. Currently, the state receives federal funds under the National Estuarine and Marine Restoration Program for Galveston Bay.

Debt financing can be a source of capital to distribute the burden of repayment over the life of the project. Debt can be financed for the short or long term. Bonds are generally sold to finance public projects. User fees or taxes are pledges to repay the bonds. General obligation and revenue bonds are the two methods widely used for financing. General obligation bonds pledge a specific portion of taxable income to repay the bonds. Revenue bonds, on the other hand, pledge revenues generated from projects to repay the bonds. General obligation bonds are considered much safer than revenue bonds and, therefore, have a lower interest rate than revenue bonds.

**D. Private Funding**

Private capital is another method of financing projects. This method has been allowed in Galveston where developer George Mitchell funded the replenishment of a small section of beach in front of his hotel and condominium project. Typically, the private developer benefits either directly or indirectly. The ability to attract private capital is somewhat limited by economics of the project and tax reforms.

## Bibliography

### Federal

1. A Federal-State Partnership in the Management of Coastal and Marine Resources, Coastal Zone Management.
2. Center For Research in Water Resources, College of Engineering, University of Texas at Austin, Evaluation of Existing Conditions and Possible Design Alternatives at Rollover Fish Pass, Texas Center for Research Technical Report CRWR -210.
3. Committee on Coastal Erosion Zone Mangement, Water Science and Technology Board, Marine Board - 1990, Commission of Engineering and Technical Systems, National Research Council, Managing Coastal Erosion, National Academy Press.
4. Federal Emergency Management Agency and Office of Ocean and Coastal Resource Management, United States Department of Commerce, NOAA, Preparing for Hurricanes and Coastal Flooding - A Handbook for Local Officials, March, 1983.
5. National Ocean Service Office of Ocean & Coastal Resources Management, Coastal Programs Division, Coastal Management Solutions to Natural Hazards, Technical Assistance Bulletin No. 103, Washington, D.C.
6. Morton, Robert A. and Jeffery G. Paine, Coastal Land Loss in Texas - An Overview.
7. United States Corps of Army Engineers, Proceeding of the North Atlantic Regional Conference, Beneficial Uses of Dredged Material, Baltimore, Maryland, May, 1987.
8. United States Corps of Army Engineers, Galveston District, Erosion Protection for Project Levees Along Galveston Bay.
9. United States Corps of Army Engineers, Galveston Bulwark Against the Sea History of the Galveston Seawall, Galveston, Texas.
10. United States Corps of Army Engineers, Galveston District, Galveston County Shore Erosion Study Feasibility Report & Environmental Impact Statement, 1985.
11. United States Corps of Army Engineers, Low Cost Shore Protection - A Property Owner's Guide, A Guide for Local Government Officials, A Guide for Engineers and Contractors, 1981.
12. United States Corps of Army Engineers, Galveston District, Review of Report on Gulf Intracoastal Waterway, Texas, Erosion at the West End of Bolivar Peninsula, April 7, 1950.

13. United States Corps of Engineers, Texas City & Vicinity, Texas Hurricane-Flood Protection Reconnaissance Report on Shore Erosion Impacting Project Levees, Galveston, Texas, January 1988.
14. United States Corps of Army Engineers, Galveston District, Texas Coast Inlet Studies, Beach Profiles, Jetty Condition Surveys and Mid-Point Surveys, 1968.
15. United States Army Engineer District Corps of Engineers, Texas Coast Shores Regional Inventory Report, Galveston, Texas, 1971
16. United States Corps of Army Engineers, Galveston District, Texas Shore Protection, June, 1981.
17. United States Department of Agriculture Soil Conservation Service, Erosion and Sediment Control Guidelines.
18. United States Department of Agriculture, Plants for Coastal Dunes of the Gulf and South Atlantic Coasts and Puerto Rico, Soil Conservation Service/Agriculture Information Bulletin 460.
19. United States Department of Commerce, Coastal Management: Solutions to Our Nation's Coastal Problems, Technical Assistance Bulletin No. 101, December, 1988.
20. United States Department of Commerce, National Oceanic and Atmosphere Administration, Coastal Zone Management Implementation Regulations.
21. United States Department of Housing and Urban Development/Office Policy, Development and Research, Federal Emergency Management Agency, Federal Insurance Administration, Design and Construction Manual for Residential Buildings in Coastal High Hazard Areas.
22. War Department Corps of Army Engineers, Report on Galveston Bay, Texas, for the Reduction of Maintenance Dredging, Galveston, Texas, May 15, 1942.
23. White, W.A., et al, Bureau of Economic Geology, University of Texas at Austin, Submerged Lands of Texas, Galveston - Houston Area, 1985.
24. Williams, S. Jeffress, Dennis A. Prins, and Edward P. Meisburger, Sediment Distribution, Sand Resources, and Geologic Character of the Inner Continental Shelf off Galveston, Texas, Miscellaneous Report No. 79-4, July, 1979.

#### Congressional Reports

25. United States Corps of Army Engineers, Galveston District, Galveston Bay Shoreline Study from April Fool Point to Kemah, (83rd Congress, 2nd Session, House Department Document No. 346) Galveston, Texas, 1954.
26. United States Corps of Army Engineers, Galveston District, Gulf Shore of Galveston Island, Texas, Beach Erosion Control Study, (83rd Congress, 1st Session, House Document No. 218) Galveston, Texas, May 22, 1953.

27. United States Corps of Army Engineers, Galveston District, Report on Beach Erosion at Galveston, Texas, (73rd Congress, 2nd Session, House Document No. 400), June 14, 1934.
28. United States Corps of Army Engineers, Galveston District, Report on Beach Erosion Control Cooperative Study of the Gulf Shore of Bolivar Peninsula, Texas (Erosion at Rollover Fish Pass), (86th Congress, 2nd Session, House Document No. 286), April 15, 1958.
29. United States Corps of Army Engineers, Galveston District, Report of Gulf Intracoastal Waterway, Texas, Erosion at the West End of Bolivar Peninsula, April 7, 1950.

### State

30. Bureau of Economic Geology, Beach and Vegetation - Line Changes at Galveston Island, Texas Erosion, Deposition, and Recovery from Hurricane Alicia.
31. Bureau of Economic Geology, The Gulf Shoreline of Texas: Processes, Characteristics and Factors.
32. Herbich, Dr. John and T.Y. Lee, Texas A&M Research Foundation, Estimated Cost for the Protection of Bridge Abutments and West Galveston Beach in the Vicinity of San Luis Pass, Report No. COE-259, College Station, Texas, February, 1982.
33. Holmberg Technologies, Galveston Shoreline Restoration and Expansion, Undercurrent Stabilization Anchor Systems, September 1, 1990.
34. King, Lauriston R. and Steven G. Olson, Coastal State Capacity for Marine Resources Management, Texas A&M.
35. Kreitler, Charles W., Bureau of Economic Geology, Lineation and Faults in the Texas Coastal Zone, The University of Texas at Austin, 1976.
36. Mauro, Gary, Texas Land Commissioner, Texas Coastal Management Plan 1990-1991, January, 1991.
37. Morton, Robert A., Bureau of Economic Geology, Shoreline Changes Between Sabine Pass and Bolivar Roads - An Analysis of Historical Changes of the Texas Shoreline, University of Texas at Austin, 1975.
38. Morton, Dr. Robert A., Bureau of Economic Geology, Shoreline Changes on Galveston Island (Bolivar Roads to San Luis Pass) An Analysis of Historical Changes of the Texas Gulf Shoreline.
39. Paine, Jeffery G. and Robert A. Morton, Bureau of Economic Geology, Historical Shoreline Changes in Trinity, Galveston, West and East Bays, Texas Gulf Coast, The University of Texas at Austin, 1986.



40. Paine, Jeffery and Robert A. Morton, Bureau of Economic Geology, Shoreline Vegetation - Line Movement, Texas Gulf Coast 1974-1982, The University of Texas at Austin, 1989.
41. Texas Legislature, Special Committee of Texas Coastline Rehabilitation 1987 Report & Recommendations 1989 Update.
42. Wang, Dr. Y.H., P.E., Department of Maritime Systems Engineering, Preliminary Designs of Improvement at Rollover Pass and Vicinity Peninsula, Texas, Texas A&M University at Galveston, Texas, 1990.
43. Wang, Y.H., Dr., Shoreline Erosion Seminar Quantitative Analysis and Design Aspects of Shoreline Protection in Galveston County, Texas, Galveston, Texas, December 14, 1991.

#### GENERAL

44. Alsop, Peter, The Use of Viscous Drag Mats to Prevent Shoreline Erosion, November 25, 1992.
45. Horizontal Dewatering System, Inc., An Introduction to HDSI and Beach Preservation, Cape Coral, Florida.
46. Kana, Ph.D., Timothy W., South Carolina Sea Grant Consortium, Beach Erosion in South Carolina.
47. McCreary, Donald R., Technique for Shoreline Erosion Control - The Mac-Blox System.
48. North Carolina Department of Natural Resources and Community Development, Division of Coastal Management, A Beach Access Handbook for Local Governments.
49. Parks, James M., Ph.D., Sailfish Point (Stuart) Florida: First Demonstration of the Dewatering Approach to Beach Stabilization - Stabeach System, Technical Paper 2-88 and Comments on Stabeach System, by Dr. Y.H. Wang.
50. State of Florida, Task Force For Beach Management, Save Florida's Beaches: A Resource Protection Initiative, February, 1990.
51. William, S. Jeffress, Kurt Dodd and Kathleen Krafft Gohn, Coasts in Crisis, U.S. Geological Survey Circular 1075, United States Printing, 1990.

#### COUNTY

52. Pate, Gerry E., Consulting Engineers, Inc., Drainage Study for Galveston County, 1968.
53. 1991-Federal Emergency Management Agency Maps.

ddBIBLI

## APPENDICES

### B. EXHIBITS

1. Zone Map Potential Sand Sources
2. Zone 1 Bolivar Peninsula
3. Zone 2 Galveston Island
4. Zone 1 Bolivar Peninsula
5. Zone 2 Galveston Island
6. Zone 3 Lower Mainland
7. Zone 3 Upper Mainland
8. Bolivar Peninsula Profile
9. Galveston Island & Bolivar Peninsula Dune Protection
10. Jetty - Rollover Pass
11. Groin Field Profile
12. West Beach Profile
13. Groin Modification
14. Roadway Termination
15. Bay Shore Park

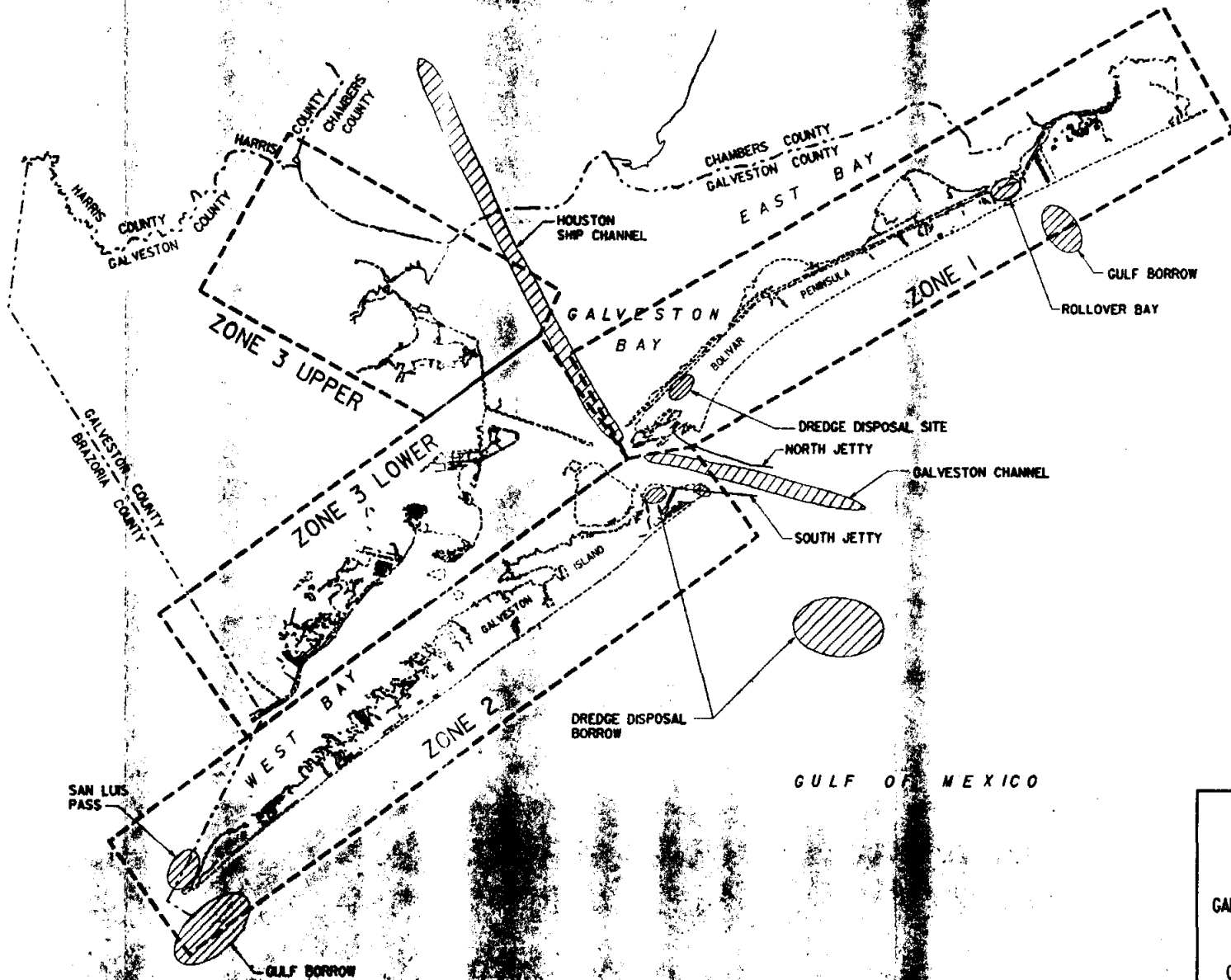

 POTENTIAL SAND SOURCES

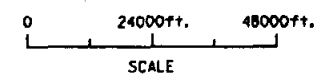

EXHIBIT I

DANNENBAUM ENGINEERING CORPORATION  
HOUSTON, TEXAS  
TEXAS A&M UNIVERSITY GALVESTON

GALVESTON COUNTY'S SHORE LINE FLOOD PROTECTION,  
RESTORATION AND IMPLEMENTATION PLAN  
FOR  
GALVESTON COUNTY AND THE CITY OF GALVESTON  
AND THE TEXAS WATER DEVELOPMENT BOARD

ZONE MAP

TREATED  
LANDING  
NARROW BEACH  
50' TO 60' WIDE  
BOAT RAMP

SPOIL AREA

15' TO 18" HIGH LEVEE  
AROUND SPOIL AREA

BANKS  
SLUFFING  
2:1

EROSION  
AT OUTFALL

BEACHES CREATED  
BY DREDGE SPOIL

80'± TO DUNE  
HIGHTIDE MARK

SHALLOW

10'± BETWEEN  
TIDE CHANGES

DUNE BREAKS

EROSION AT OUTFALL

DUNES 6'±

DUNE BREAK

BOLIVIA

BALVESTON BAY

MEXICO

DUNE BREAKS

EROSION AT  
DRAINAGE  
OUTFALL

DUNE BREAKS

4' AND 5' DUNES

110' BEACH WIDTH

THREE HOUSES  
IN THE DUNES

180' BEACH WIDTH  
WITH 10' DUNES

EROSION AT  
DRAINAGE  
OUTFALL

THREE HOUSES  
ON BACKSIDE  
OF DUNES

NARROW BEACH

LEFT BEACH

DUNE BREAKS

DUNE CUT

DUNE CUT

PENNSILVANIA

WETLANDS

WETLANDS

WETLANDS

WETLANDS

HEAVY VEGETATION

BOYD

WETLANDS

SHALLOW

BAY

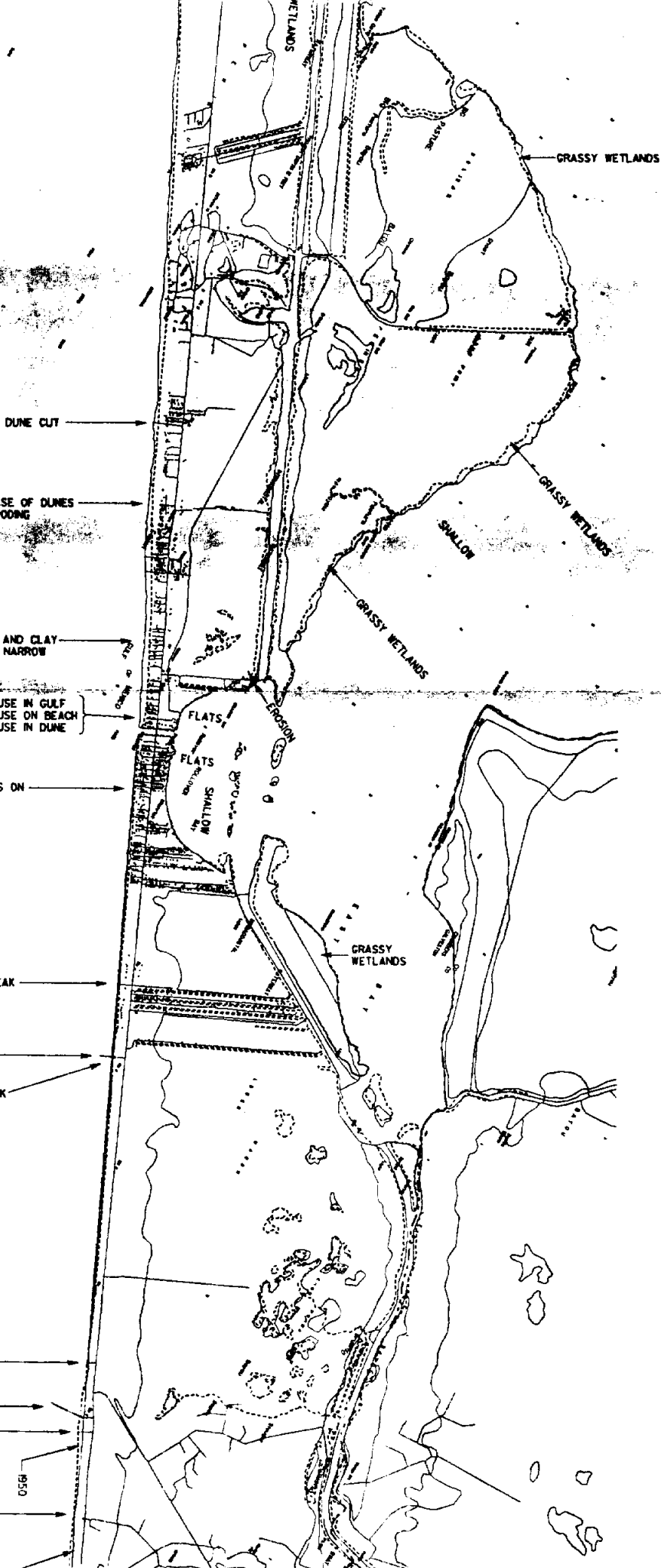

DUNE CUT

BASE OF DUNES ERODING

SHELL AND CLAY BEACH NARROW

ONE HOUSE IN GULF  
ONE HOUSE ON BEACH  
ONE HOUSE IN DUNE

HOUSES ON DUNES

DUNE BREAK

PIER

DUNE BREAK

DUNE BREAK

PIER

DUNE BREAK

1950

NARROW BEACH

GRASSY WETLANDS

GRASSY WETLANDS

GRASSY WETLANDS

GRASSY WETLANDS

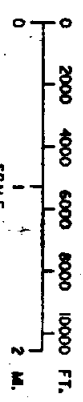

LEGEND

1950  
1990

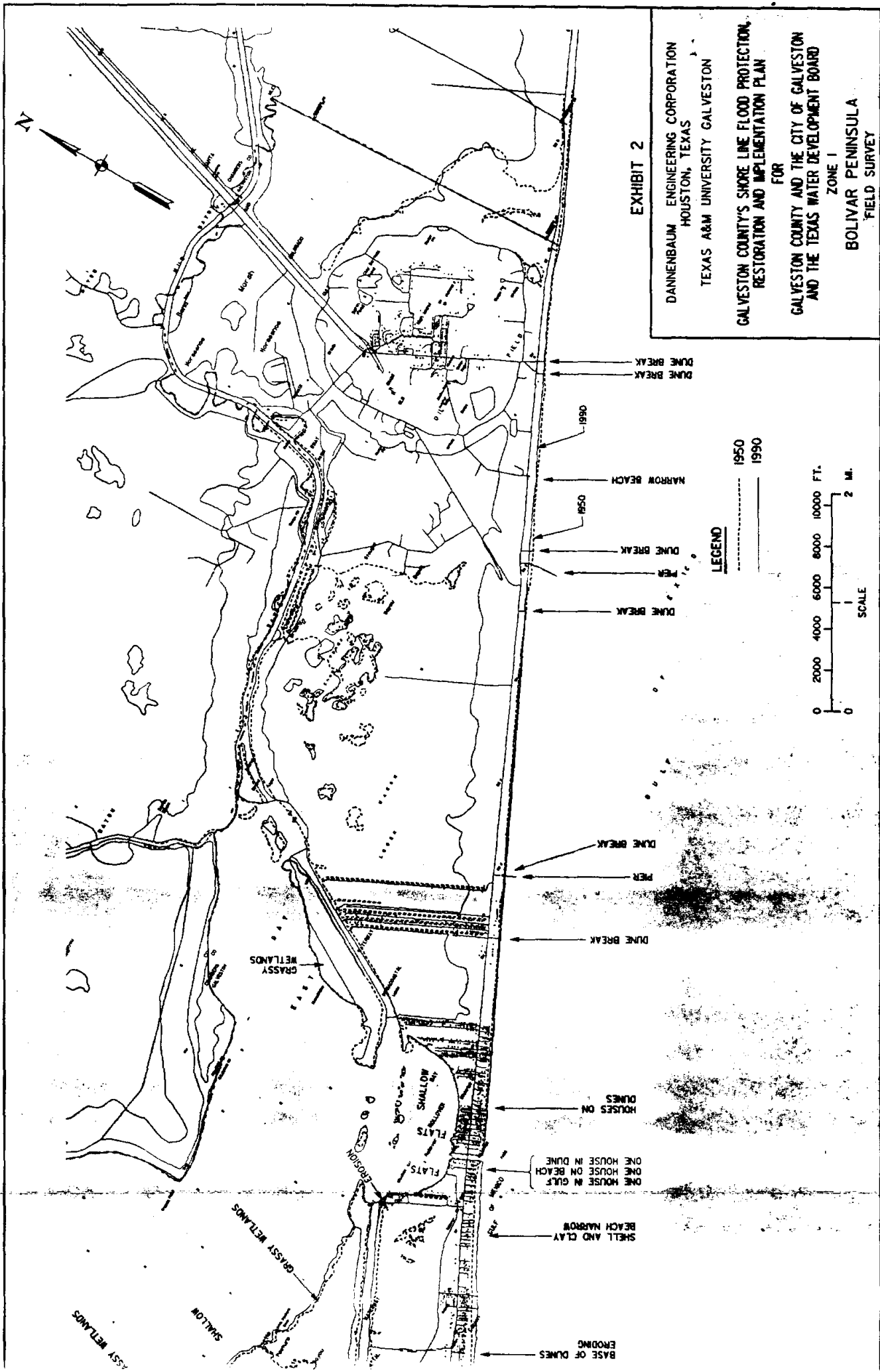

**EXHIBIT 2**

DANNENBAUM ENGINEERING CORPORATION  
 HOUSTON, TEXAS  
 TEXAS A&M UNIVERSITY GALVESTON

**GALVESTON COUNTY'S SHORE LINE FLOOD PROTECTION,  
 RESTORATION AND IMPLEMENTATION PLAN**  
 FOR  
**GALVESTON COUNTY AND THE CITY OF GALVESTON  
 AND THE TEXAS WATER DEVELOPMENT BOARD**

**ZONE 1  
 BOLIVAR PENINSULA  
 FIELD SURVEY**

**LEGEND**  
 - - - - - 1950  
 \_\_\_\_\_ 1990

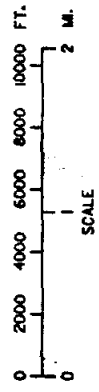

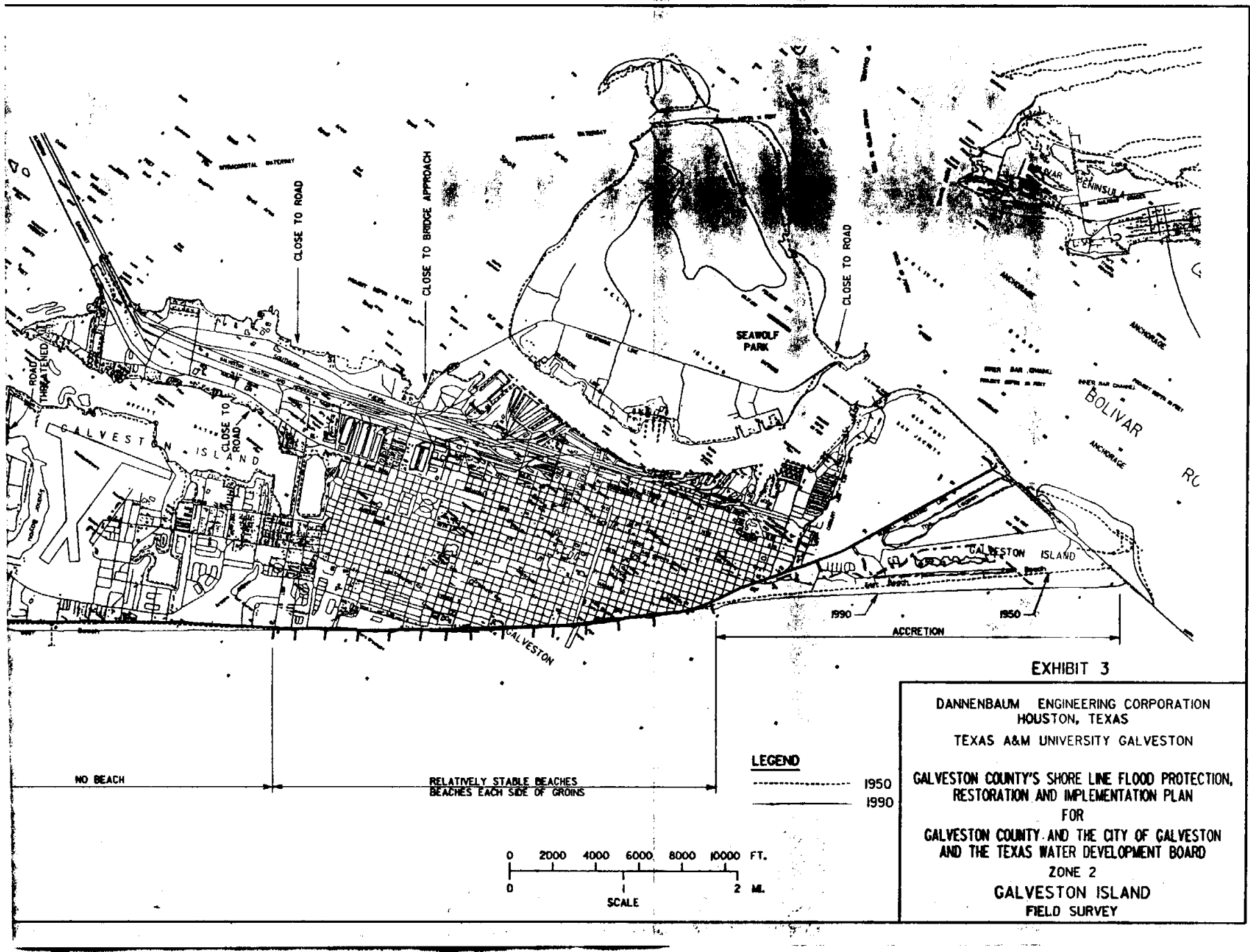

**EXHIBIT 3**

DANNENBAUM ENGINEERING CORPORATION  
 HOUSTON, TEXAS  
 TEXAS A&M UNIVERSITY GALVESTON  
 GALVESTON COUNTY'S SHORE LINE FLOOD PROTECTION,  
 RESTORATION AND IMPLEMENTATION PLAN  
 FOR  
 GALVESTON COUNTY AND THE CITY OF GALVESTON  
 AND THE TEXAS WATER DEVELOPMENT BOARD  
 ZONE 2  
 GALVESTON ISLAND  
 FIELD SURVEY

**LEGEND**  
 ----- 1950  
 \_\_\_\_\_ 1990

0 2000 4000 6000 8000 10000 FT.  
 0 2 MI.  
 SCALE

NO BEACH  
 RELATIVELY STABLE BEACHES  
 BEACHES EACH SIDE OF GROINS

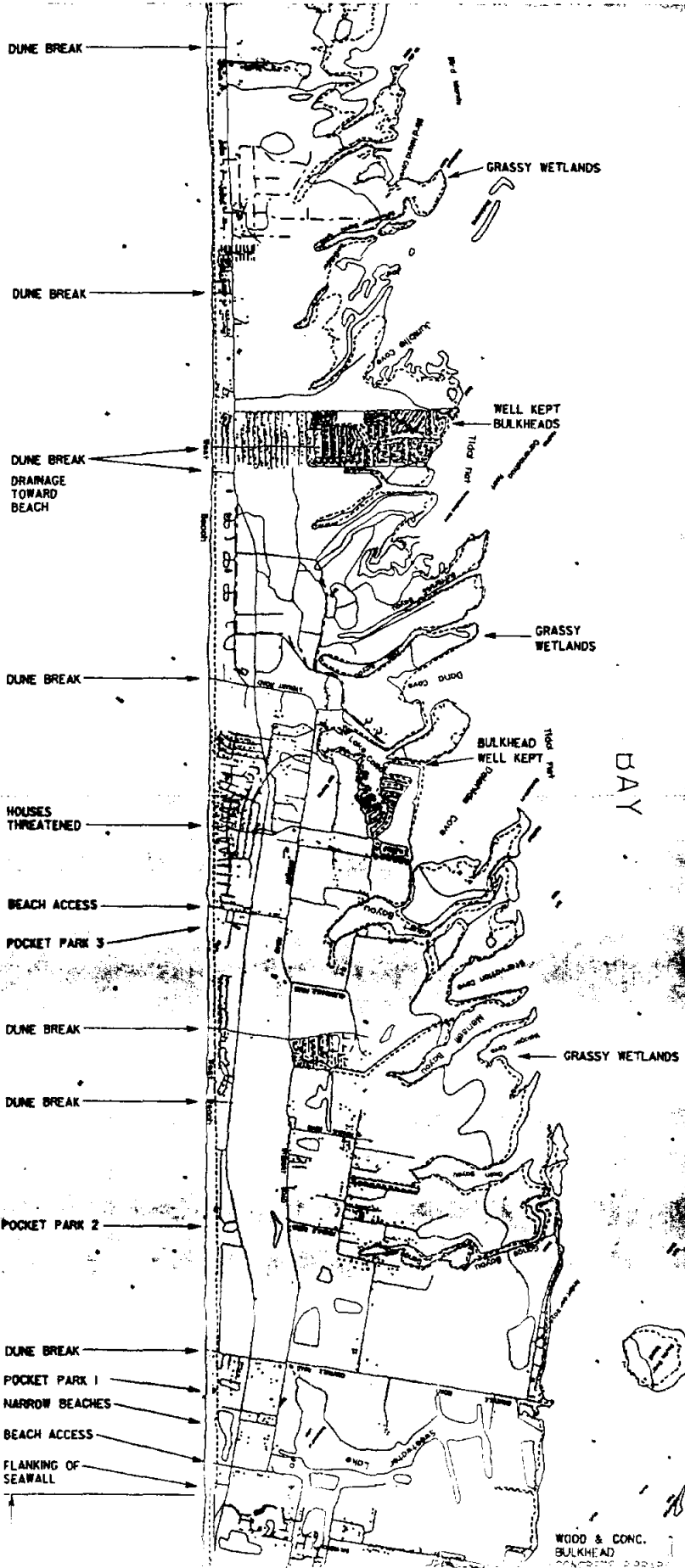



SPRINGFIELD  
HOFF - SECTION ONE  
CALYBLAND BEACH FIELD SURVEY - BULKHEAD

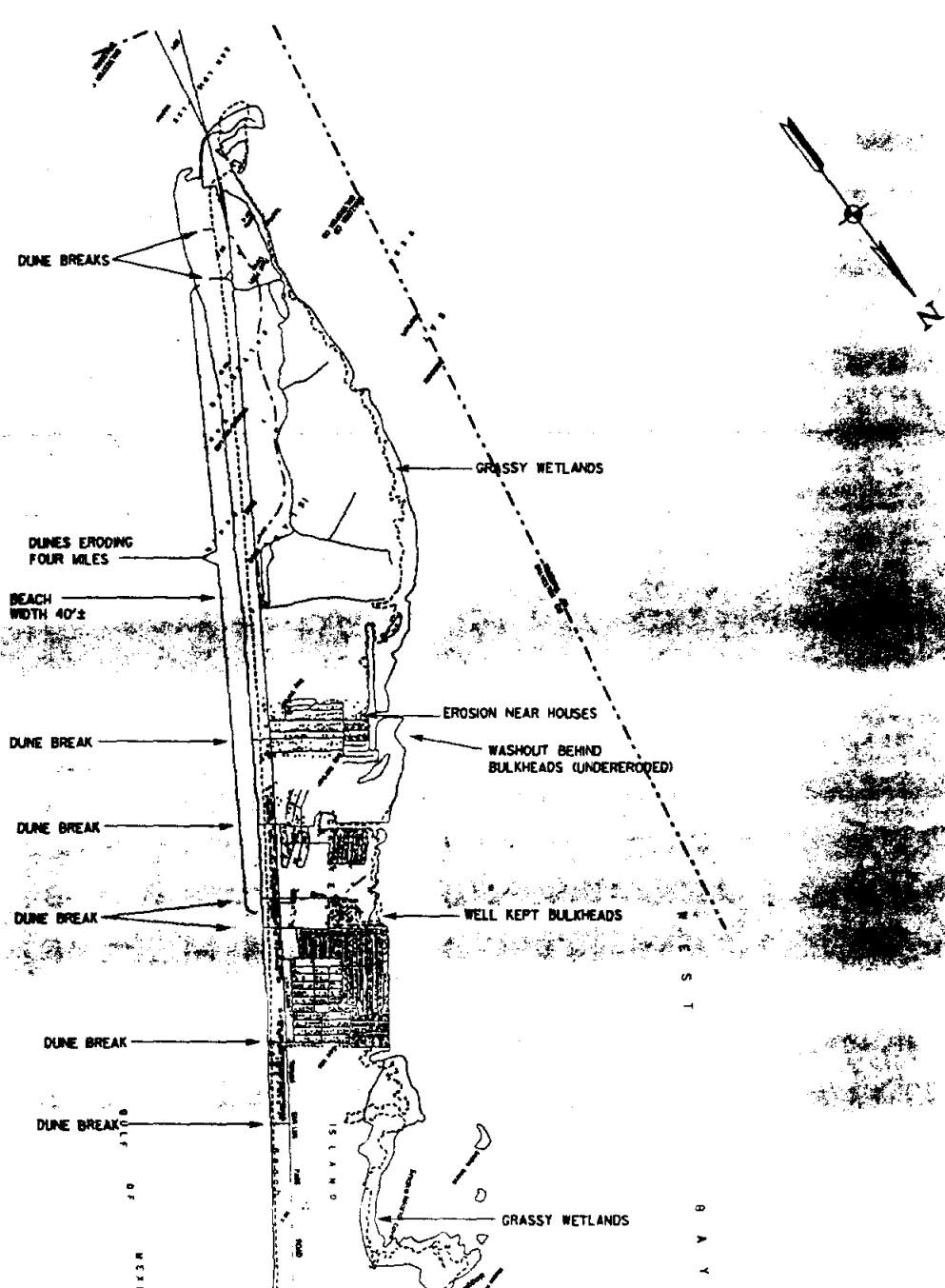

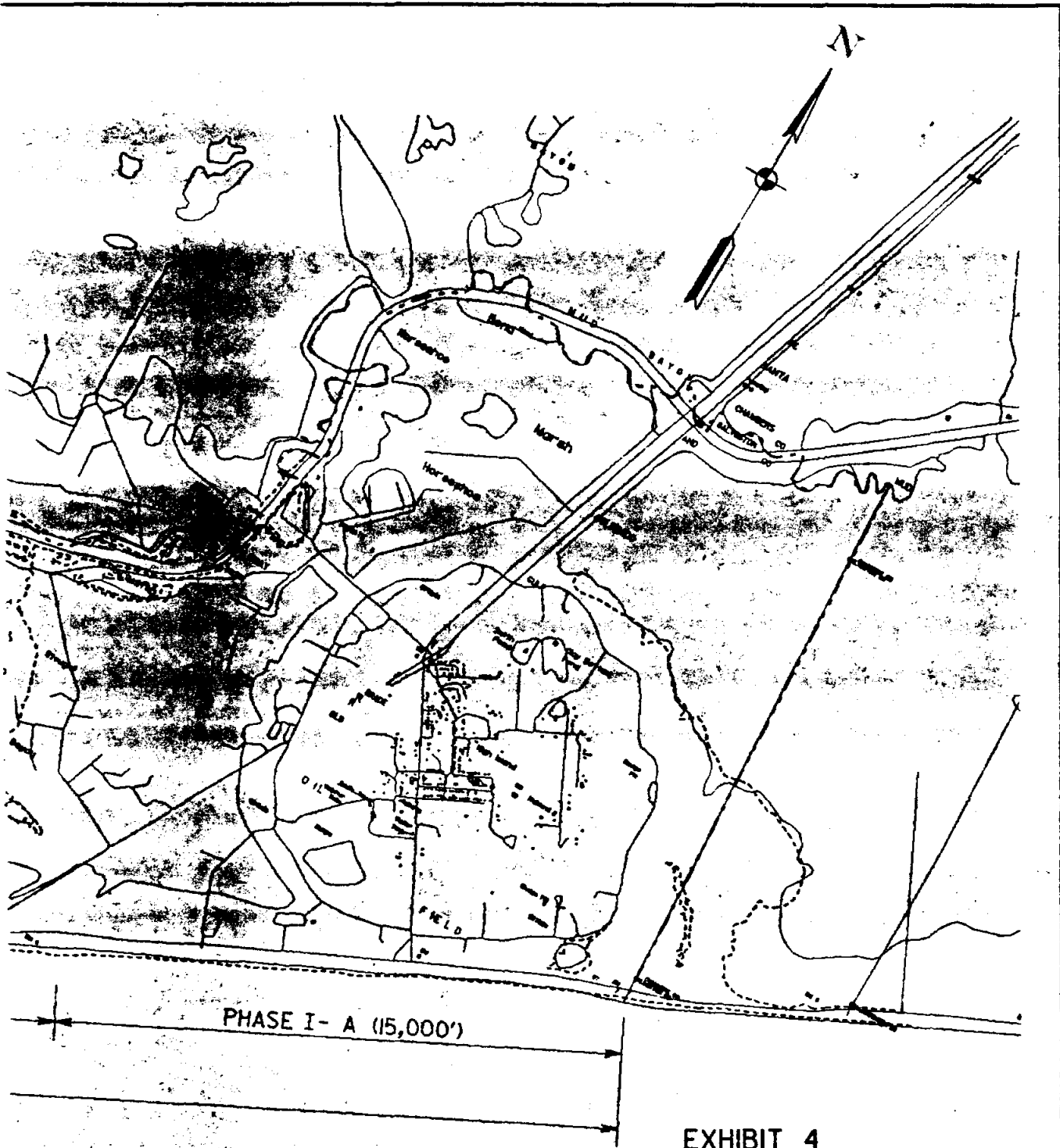

EXHIBIT 4

**LEGEND**

----- 1953  
 \_\_\_\_\_ 1990

4000ft.      8000ft.

SCALE

DANNENBAUM ENGINEERING CORPORATION  
 HOUSTON, TEXAS  
 TEXAS A&M UNIVERSITY GALVESTON  
 GALVESTON COUNTY'S SHORE LINE FLOOD PROTECTION,  
 RESTORATION AND IMPLEMENTATION PLAN  
 FOR  
 GALVESTON COUNTY AND THE CITY OF GALVESTON  
 AND THE TEXAS WATER DEVELOPMENT BOARD  
 ZONE I  
 BOLIVAR PENINSULA

PHASE II - 14,000'  
59 ACRES LOST  
6 FT./YR.

PHASE I - C (15,000')

PHASE I - B (14,500')  
PHASE I  
62 ACRES LOST  
2.9 FT./YR.

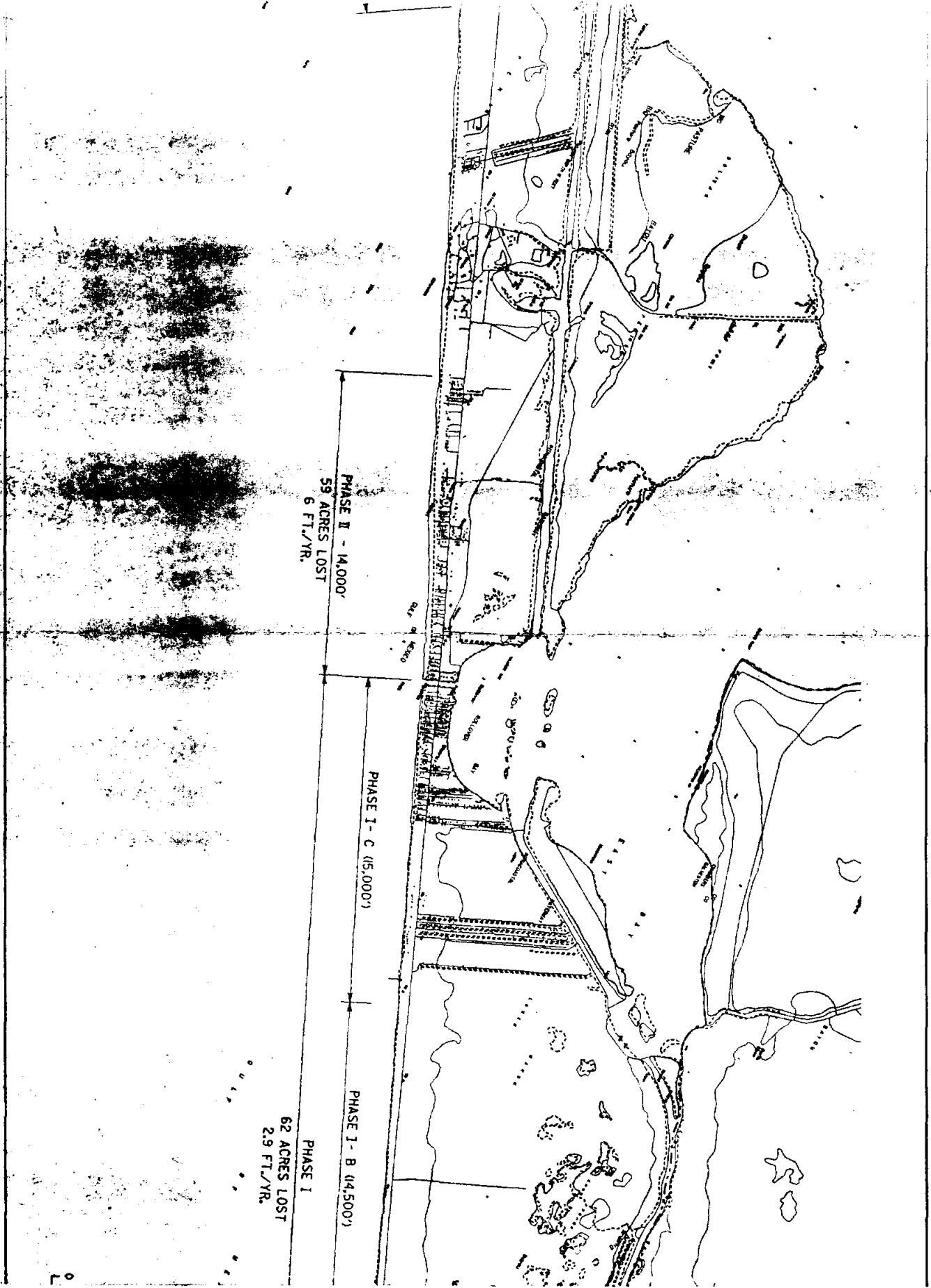

PHASE I - 52.9 ACRES LOST  
10.2 FT./YR.

PHASE IV - 10,000'  
20 ACRES LOST  
2.8 FT./YR.

PHASE III - 28,000'  
43 ACRES LOST  
2.1 FT./YR.

OF MEXICO

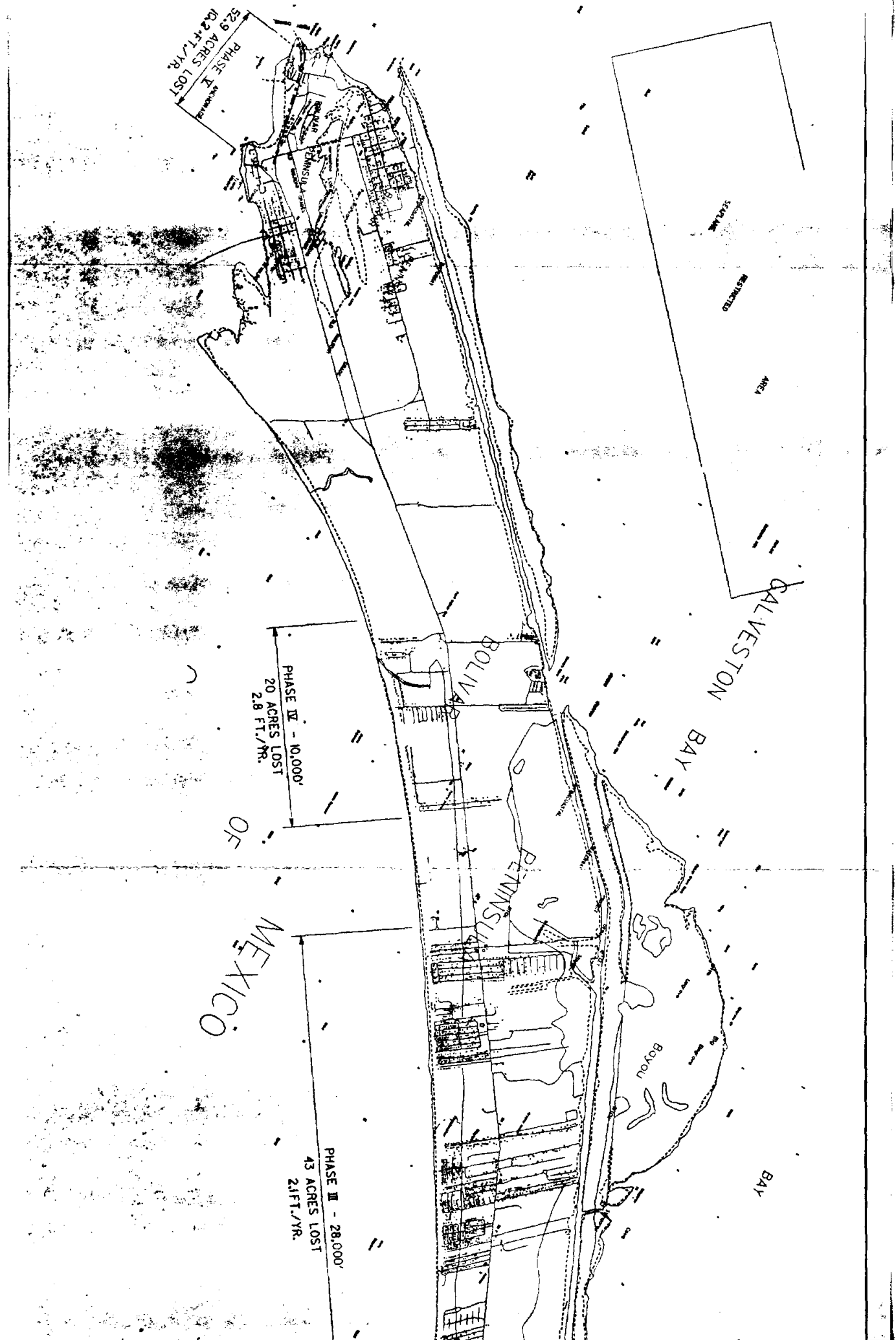

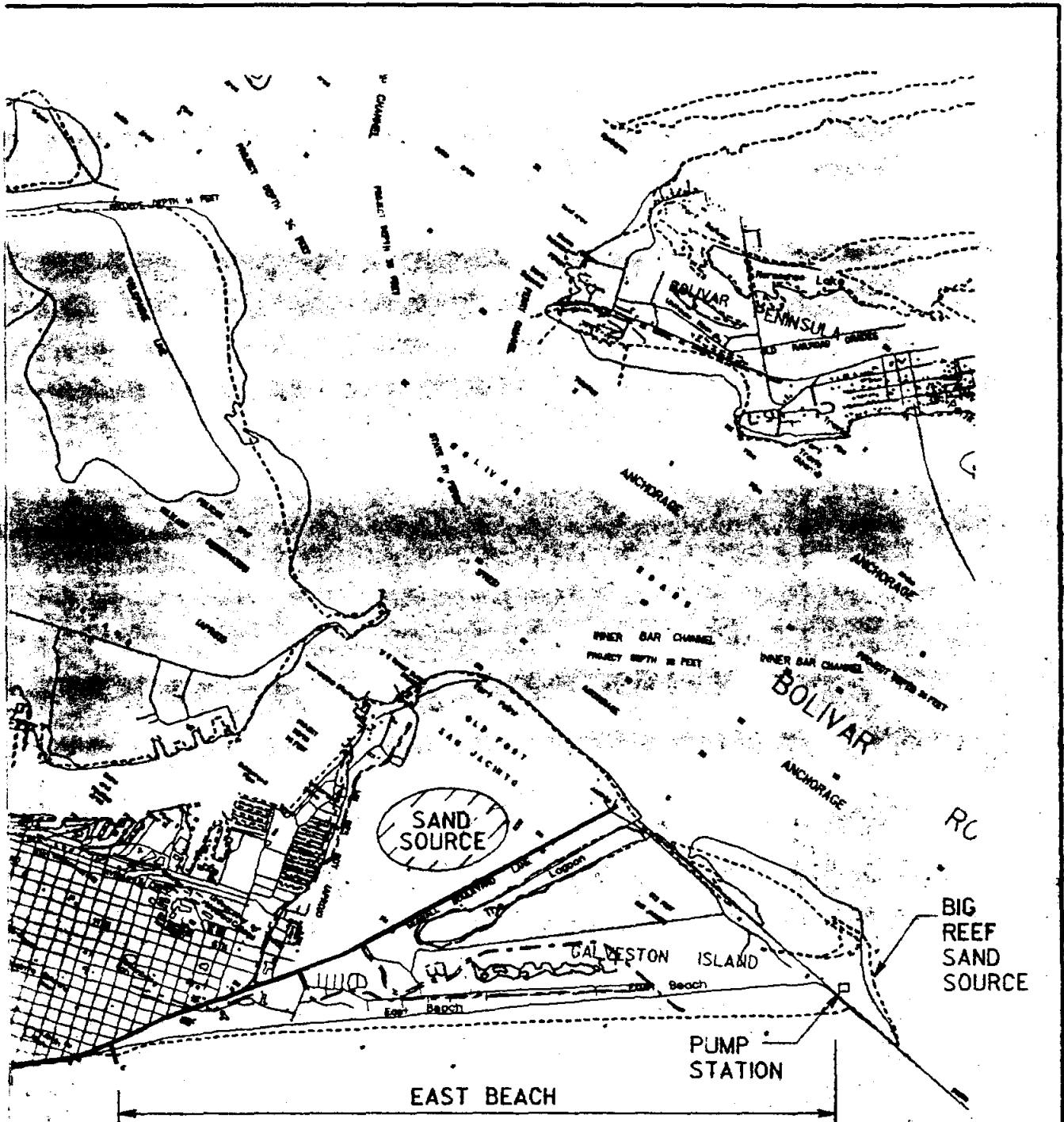

EXHIBIT 5

DANNENBAUM ENGINEERING CORPORATION  
 HOUSTON, TEXAS  
 TEXAS A&M UNIVERSITY GALVESTON

GALVESTON COUNTY'S SHORE LINE FLOOD PROTECTION,  
 RESTORATION AND IMPLEMENTATION PLAN  
 FOR  
 GALVESTON COUNTY AND THE CITY OF GALVESTON  
 AND THE TEXAS WATER DEVELOPMENT BOARD

**ZONE 2**  
**GALVESTON ISLAND**

**LEGEND**

----- 1953  
 \_\_\_\_\_ 1990

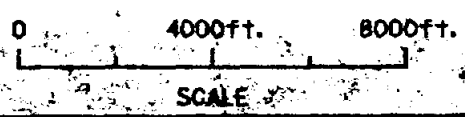

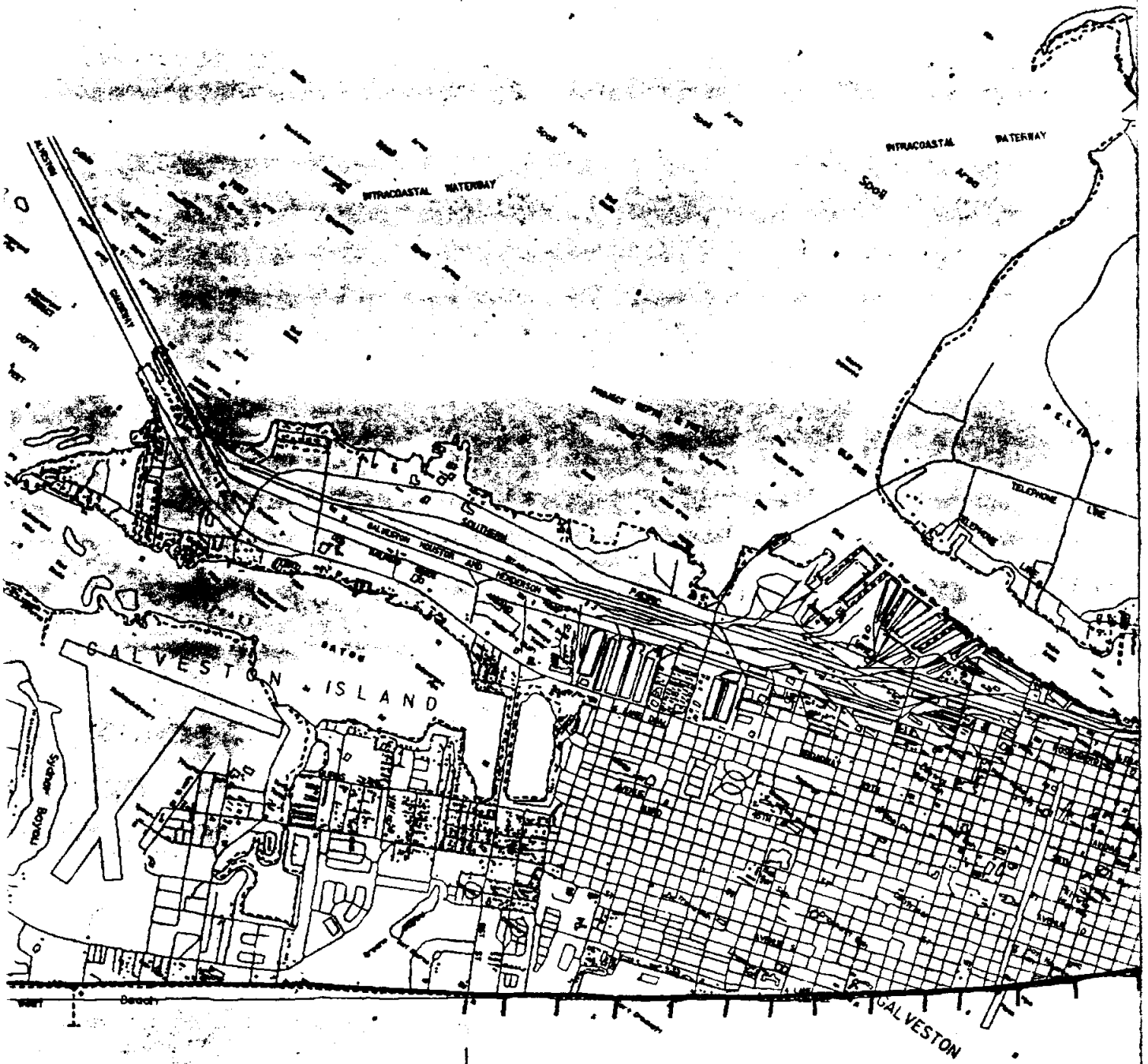

PHASE II  
 ACRES LOST  
 3 FT./YR.  
 (SEE GRION FIELD PROFILE)

PHASE I  
 8.5 ACRES LOST  
 1.5 FT./YR.  
 (SEE GRION FIELD PROFILE)

SEAWALL

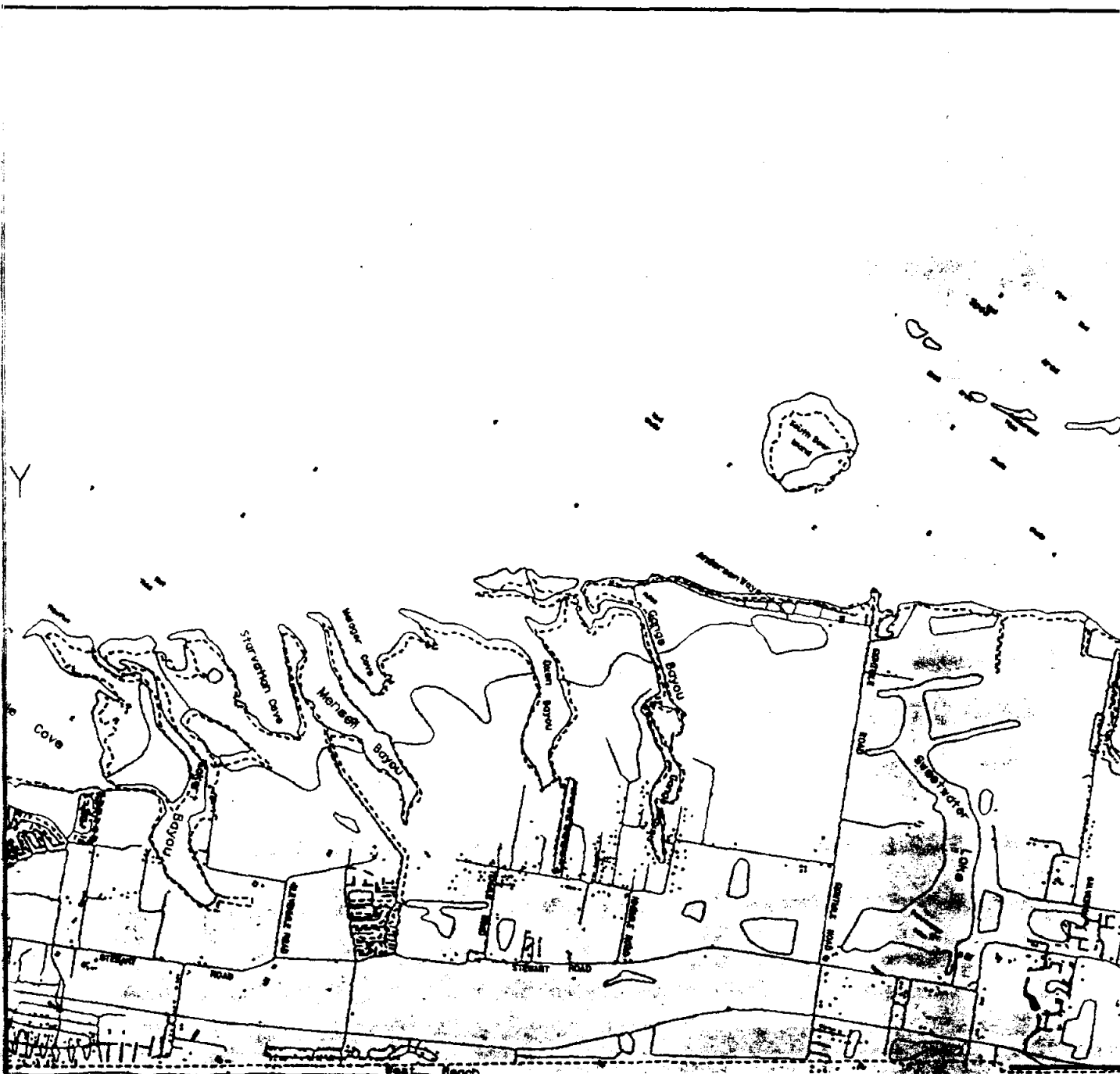

PHASE III  
 75 ACRES LOST  
 5.8 FT./YR.  
 (SEE WEST BEACH PROFILE)

PROPOSED FEEDER  
 BEACH SITE

15  
 (SIMILAR)

BA

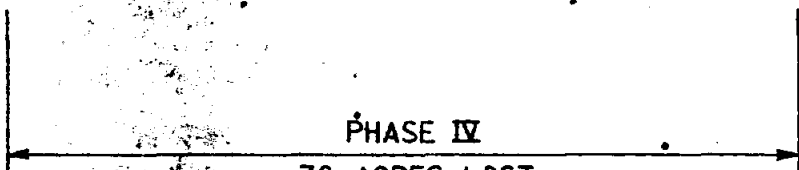
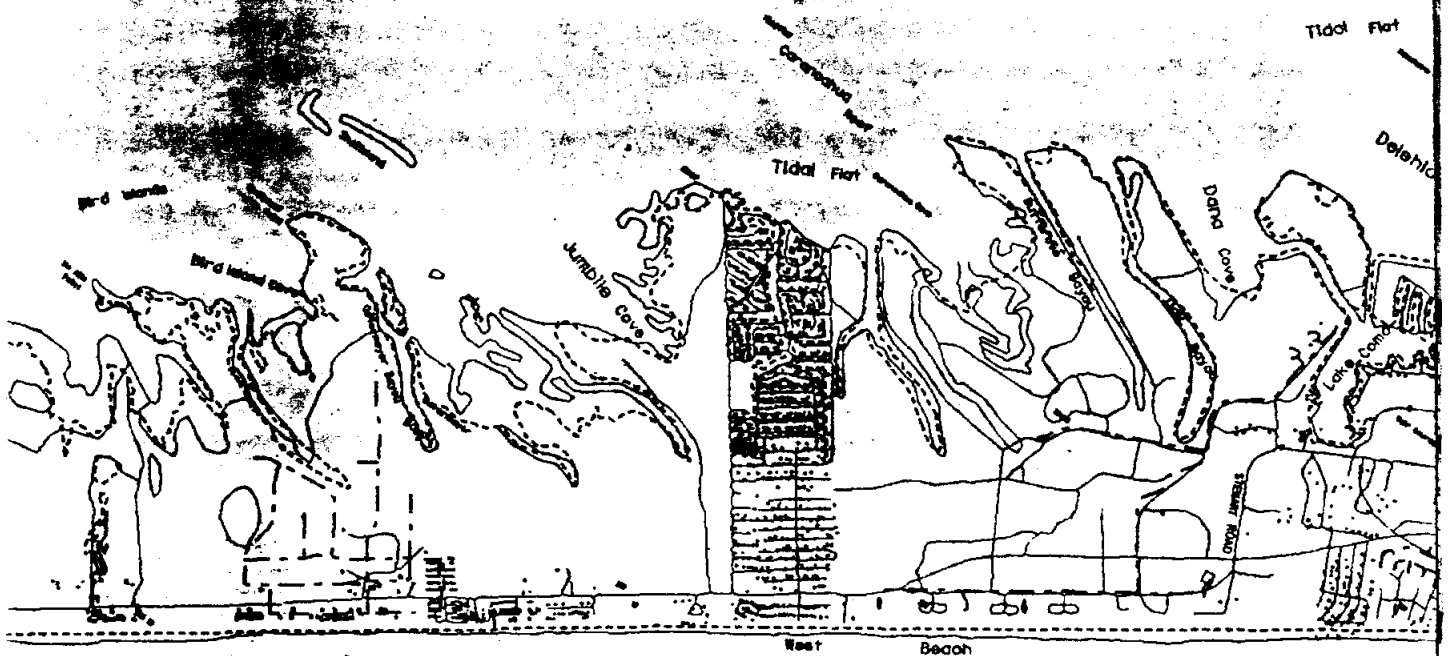

PHASE IV  
36 ACRES LOST  
2.8 FT./YR.  
(SEE WEST BEACH PROFILE)

WEST BEACH



WEST BAY

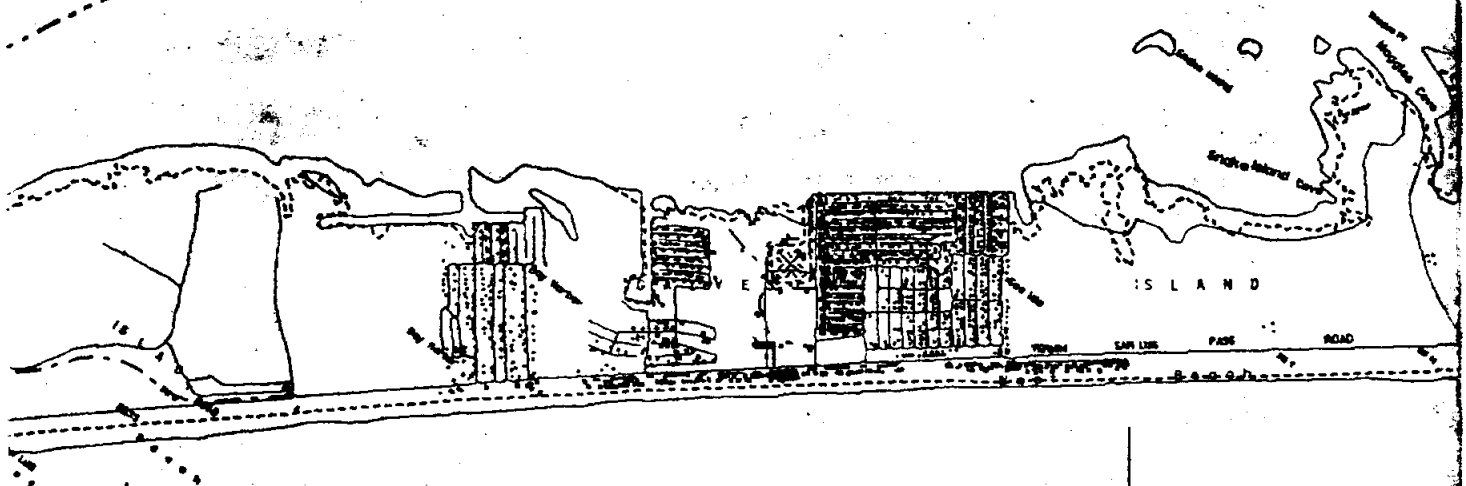

PHASE V

98.5 ACRES LOST  
7.7 FT./YR.  
(SEE WEST BEACH PROFILE)

GULF OF MEXICO

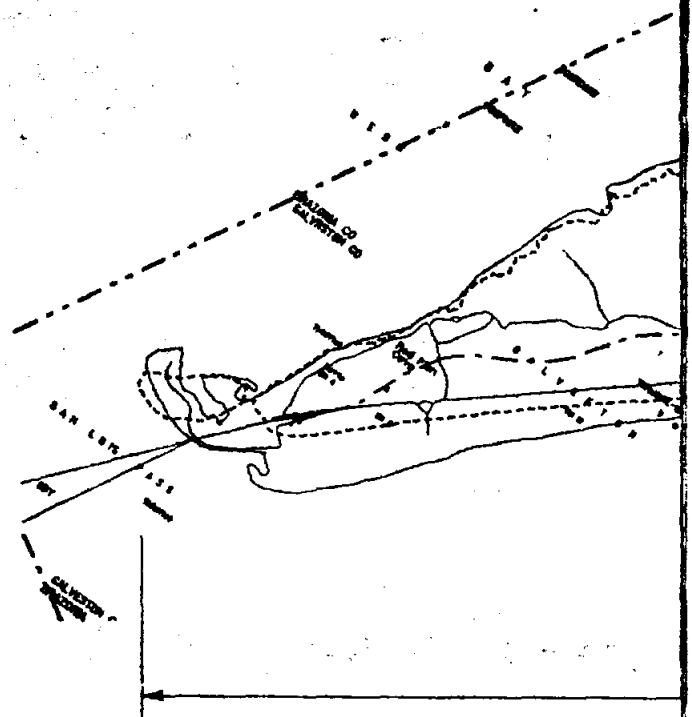
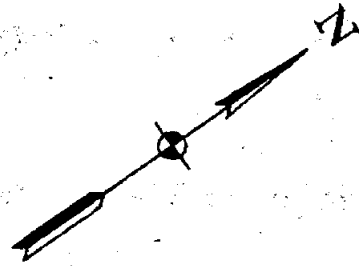

SPRINGFIELD  
MAY 1944  
SALINA BEACH TOWNSHIP

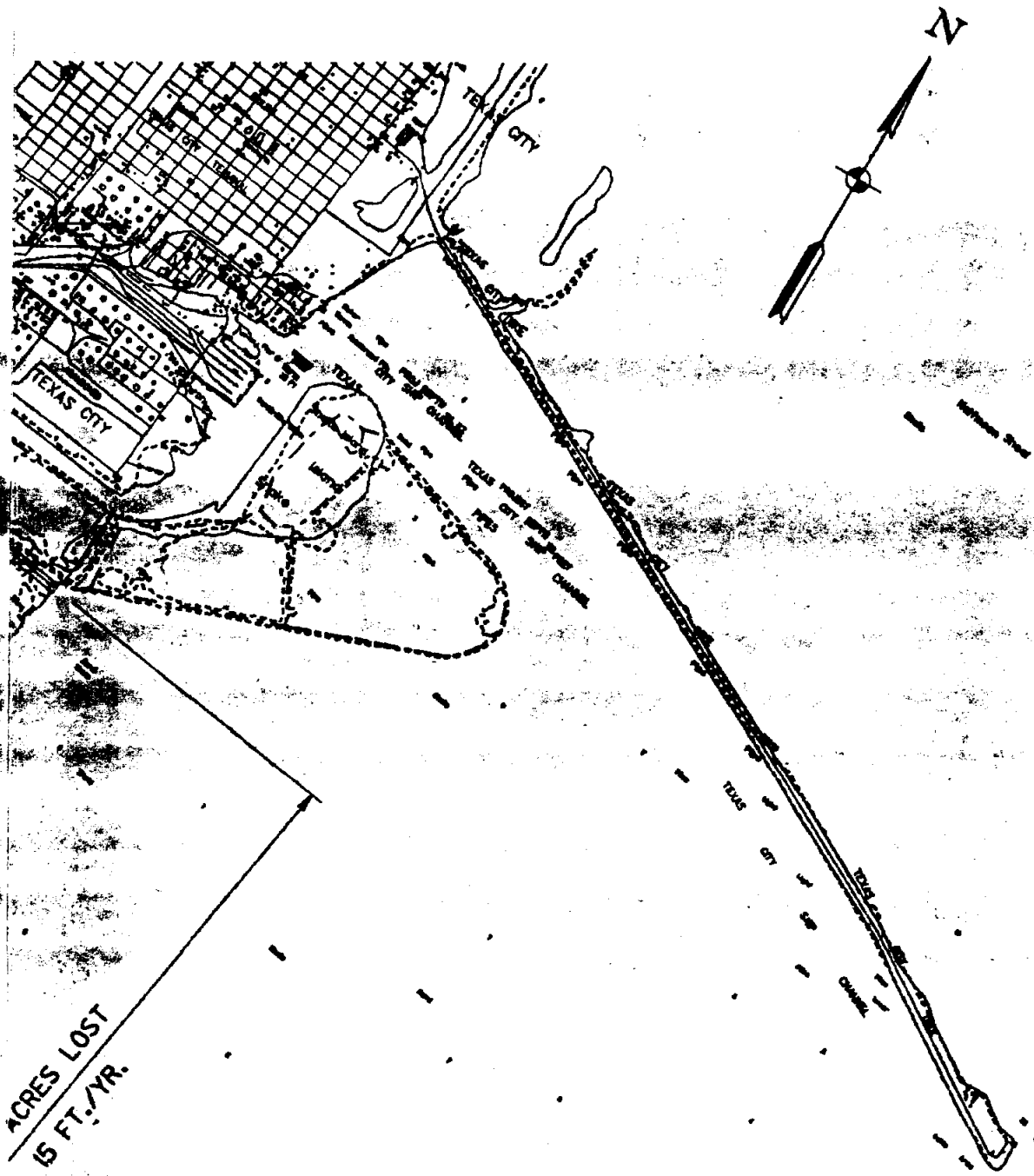

EXHIBIT 6

DANNENBAUM ENGINEERING CORPORATION  
 HOUSTON, TEXAS  
 TEXAS A&M UNIVERSITY GALVESTON  
 GALVESTON COUNTY'S SHORE LINE FLOOD PROTECTION,  
 RESTORATION AND IMPLEMENTATION PLAN  
 FOR  
 GALVESTON COUNTY AND THE CITY OF GALVESTON  
 AND THE TEXAS WATER DEVELOPMENT BOARD  
 ZONE 3  
 LOWER MAINLAND

4000ft. 8000ft.  
 SCALE





100 ACRES LOST  
7.5 FT./YR.

WEST

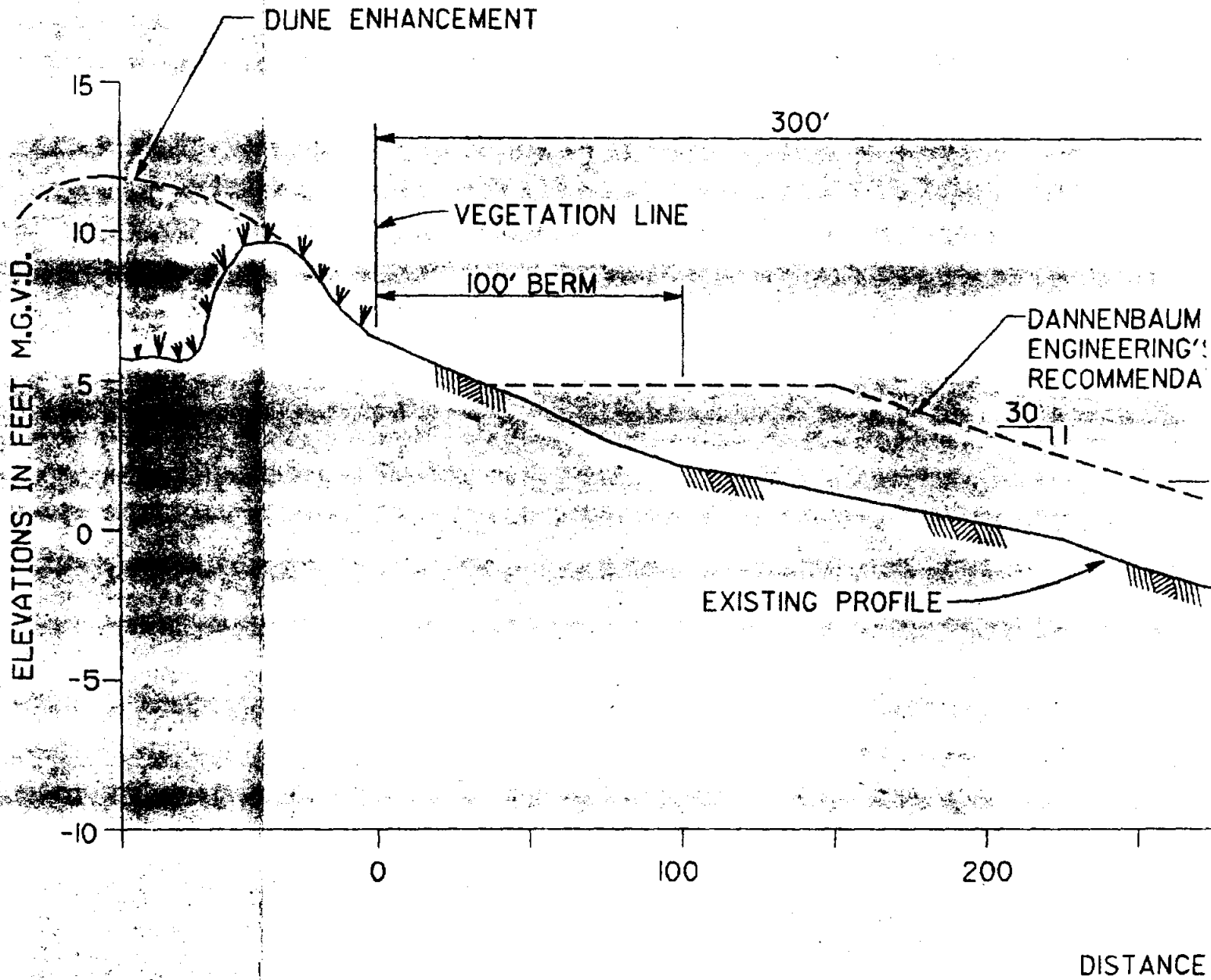

# TYPICAL BOLIVAR PENIN

SCALE : 1"=40' HORIZ.  
 1"=4' VERT.

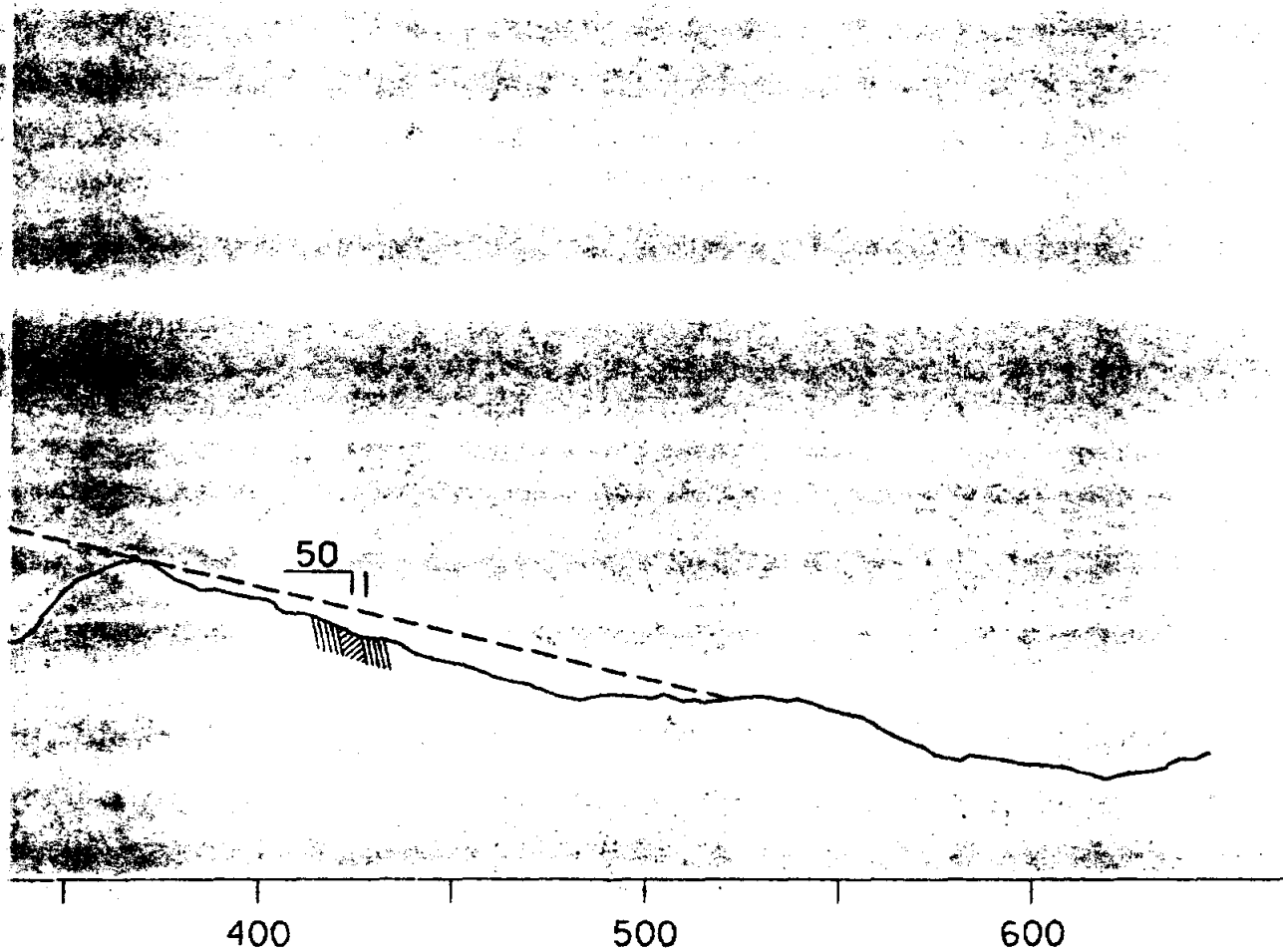

# PROFILE

## EXHIBIT 8

DANNENBAUM ENGINEERING CORPORATION  
HOUSTON, TEXAS

TEXAS A&M UNIVERSITY GALVESTON

GALVESTON COUNTY'S SHORE LINE FLOOD PROTECTION,  
RESTORATION AND IMPLEMENTATION PLAN  
FOR

GALVESTON COUNTY AND THE CITY OF GALVESTON  
AND THE TEXAS WATER DEVELOPMENT BOARD

GALVESTON COUNTY SHORE EROSION STUDY

**BOLIVAR PENINSULA PROFILE**

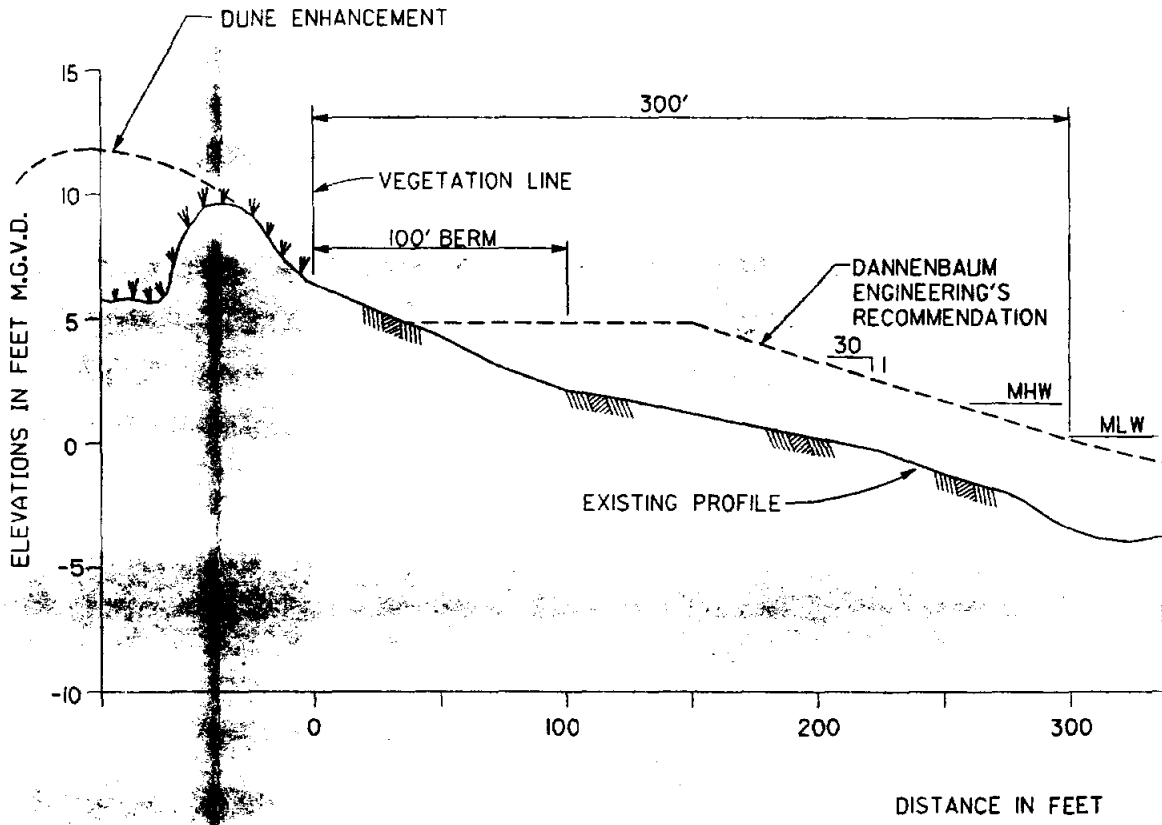

# TYPICAL BOLIVAR PENINSULA

SCALE : 1"=40' HORIZ.  
1"=4' VERT.



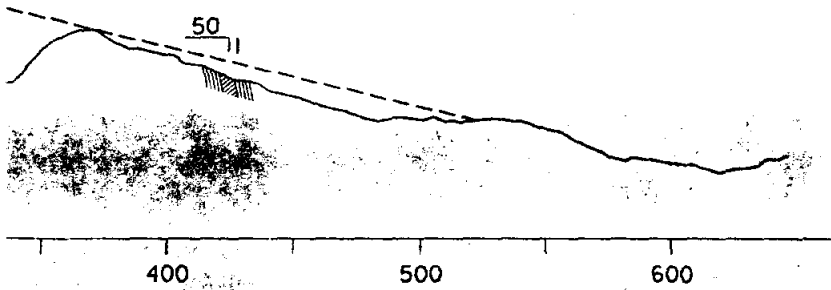

PROFILE

EXHIBIT 8

DANNENBAUM ENGINEERING CORPORATION  
HOUSTON, TEXAS  
TEXAS A&M UNIVERSITY GALVESTON

GALVESTON COUNTY'S SHORE LINE FLOOD PROTECTION,  
RESTORATION AND IMPLEMENTATION PLAN  
FOR

GALVESTON COUNTY AND THE CITY OF GALVESTON  
AND THE TEXAS WATER DEVELOPMENT BOARD

GALVESTON COUNTY SHORE EROSION STUDY

**BOLIVAR PENINSULA PROFILE**



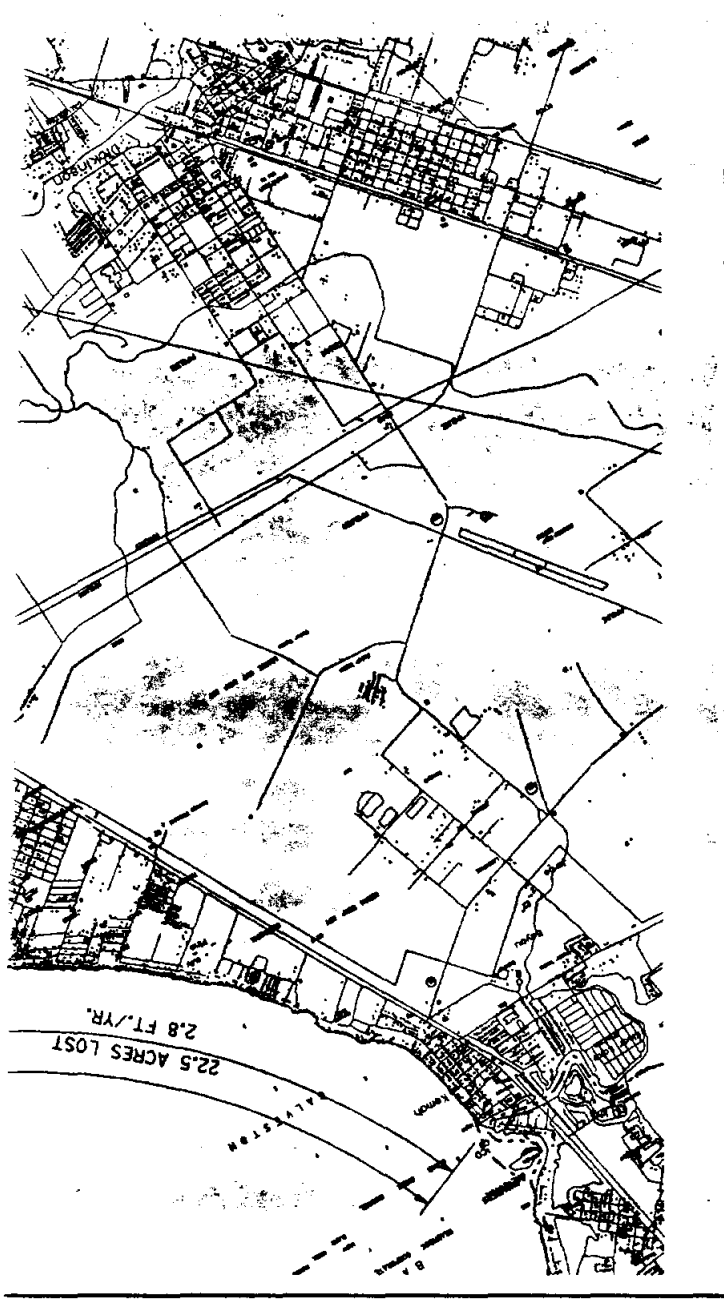

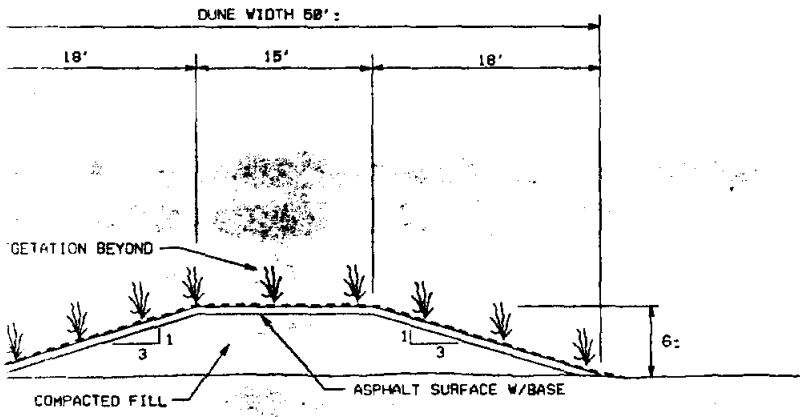

- GALVESTON ISLAND - 18 DUNE BREAKS EXIST ALLOWING VEHICULAR ACCESS TO THE BEACH
- BOLIVAR PENINSULA - 50 DUNE BREAKS EXIST ALLOWING VEHICULAR ACCESS TO THE BEACH

**SECTION**  
N.T.S.

**EXHIBIT 9**

DANNENBAUM ENGINEERING CORPORATION  
HOUSTON, TEXAS  
TEXAS A&M UNIVERSITY GALVESTON

GALVESTON COUNTY'S SHORE LINE FLOOD PROTECTION,  
RESTORATION AND IMPLEMENTATION PLAN  
FOR  
GALVESTON COUNTY AND THE CITY OF GALVESTON  
AND THE TEXAS WATER DEVELOPMENT BOARD

GALVESTON ISLAND & BOLIVAR PENINSULA  
DUNE PROTECTION



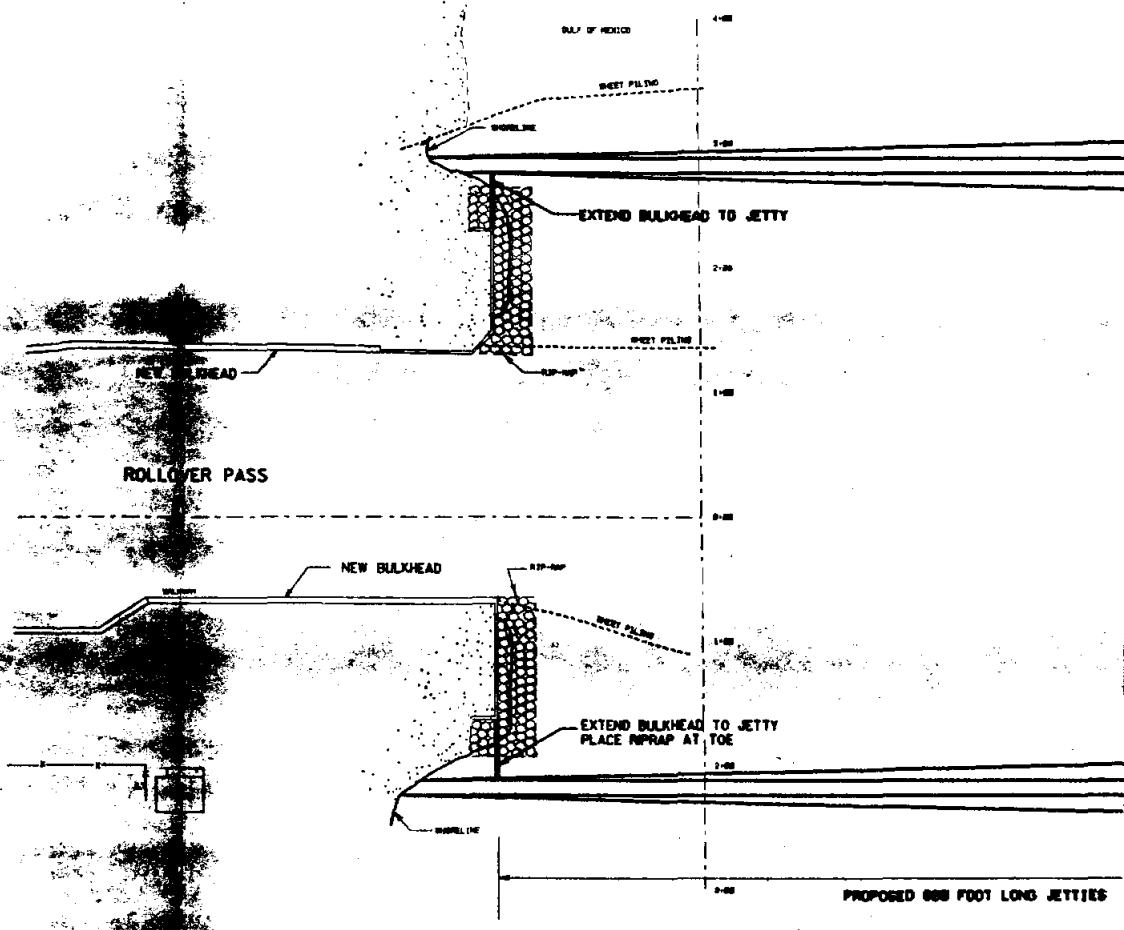

**PLAN**  
 SCALE: P=100'

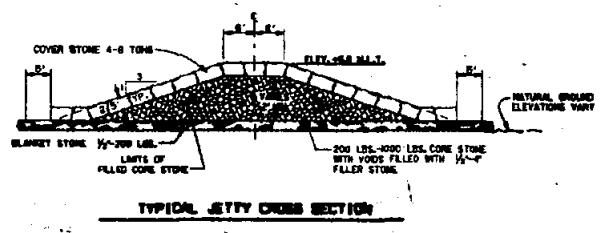

**TYPICAL JETTY CROSS SECTION**

ENGINEERING DRAWING  
 JETTY & ROLLOVER PASS  
 SHEET NO. 100



PROPOSED RUBBLE JETTY



PROPOSED RUBBLE JETTY

EXHIBIT 10

DANNENBAUM ENGINEERING CORPORATION  
HOUSTON, TEXAS  
TEXAS A&M UNIVERSITY GALVESTON

GALVESTON COUNTY'S SHORE LINE FLOOD PROTECTION,  
RESTORATION AND IMPLEMENTATION PLAN  
FOR

GALVESTON COUNTY AND THE CITY OF GALVESTON  
AND THE TEXAS WATER DEVELOPMENT BOARD

JETTY - ROLLOVER PASS

ELEVATIONS IN FEET M.G.V.D.

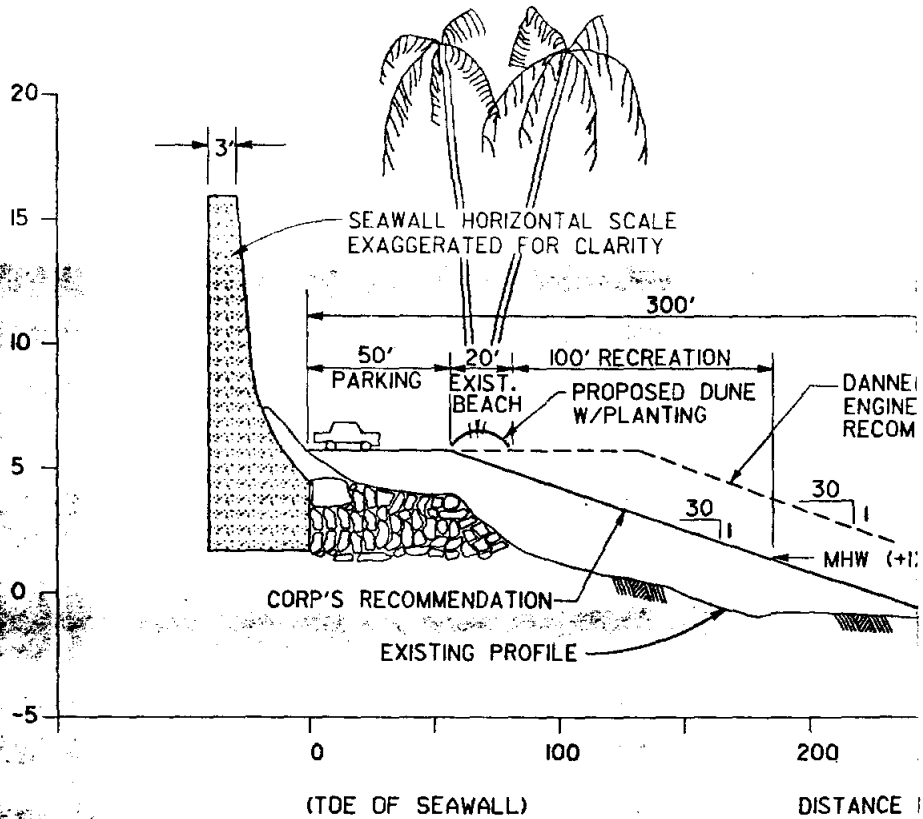

### TYPICAL GROIN FIELD

'Typical Groin Field Profile'  
Galveston County Shore Erosion Study -  
U.S. Corps of Engineers 1985 (Ref. 10)  
[Taken from Ref. 5, Fig. 53, Pg. 200]  
Modified by Dannenbaum Engineering Corp

THIS SECTION HAS  
BEEN REVISED - SEE OTHER FIELD PROFILE (CALIPSO)



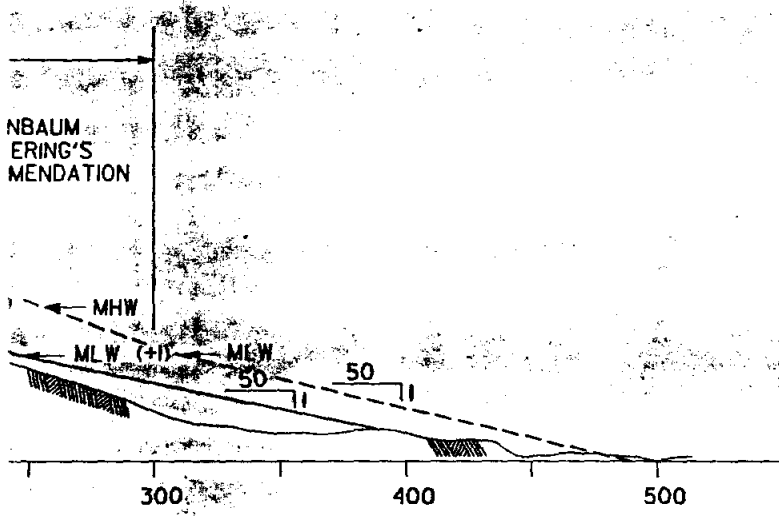

IN FEET

PROFILE

EXHIBIT B

DANNENBAUM ENGINEERING CORPORATION  
 HOUSTON, TEXAS  
 TEXAS A&M UNIVERSITY GALVESTON

GALVESTON COUNTY'S SHORE LINE FLOOD PROTECTION,  
 RESTORATION AND IMPLEMENTATION PLAN  
 FOR  
 GALVESTON COUNTY AND THE CITY OF GALVESTON  
 AND THE TEXAS WATER DEVELOPMENT BOARD  
GALVESTON COUNTY SHORE EROSION STUDY

GROIN FIELD PROFILE

poration

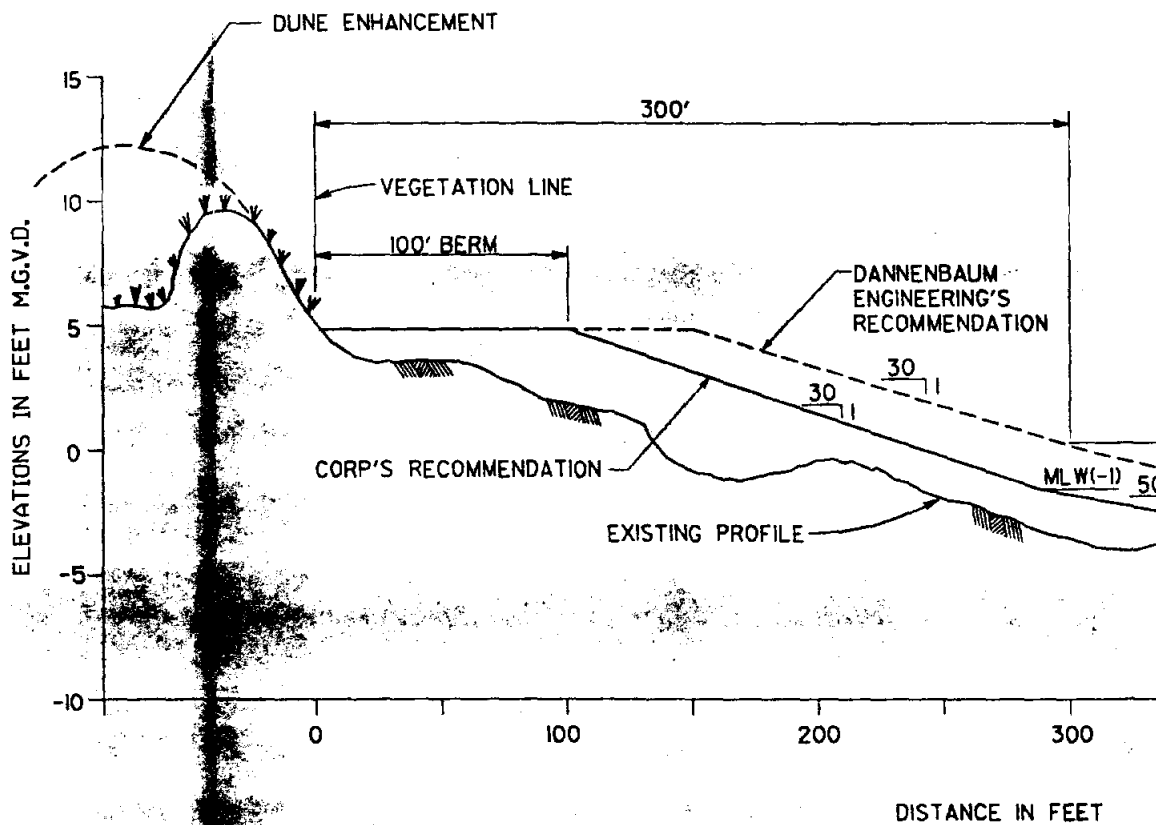

## TYPICAL WEST BEACH P

Typical West Beach Profile  
 Galveston County Shore Erosion Study  
 US Corps of Engrs 1985 (Ref 10)  
 [Taken from Ref. 5, Fig. 56, Pg. 204]  
 Modified by Dannenbaum Engineering Corporation

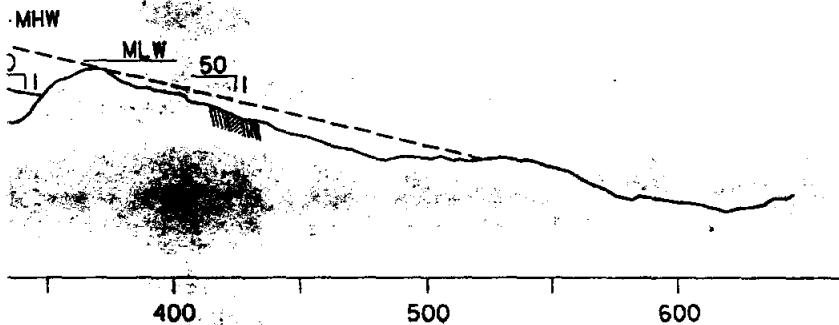

PROFILE

**EXHIBIT 12**

DANNENBAUM ENGINEERING CORPORATION  
HOUSTON, TEXAS  
TEXAS A&M UNIVERSITY GALVESTON

GALVESTON COUNTY'S SHORE LINE FLOOD PROTECTION,  
RESTORATION AND IMPLEMENTATION PLAN  
FOR  
GALVESTON COUNTY AND THE CITY OF GALVESTON  
AND THE TEXAS WATER DEVELOPMENT BOARD  
GALVESTON COUNTY SHORE EROSION STUDY  
**WEST BEACH PROFILE**

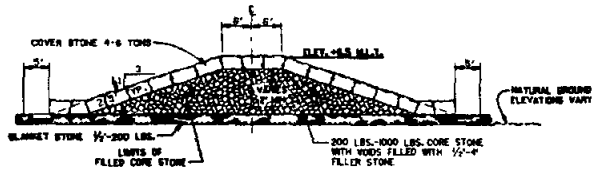

SECTION

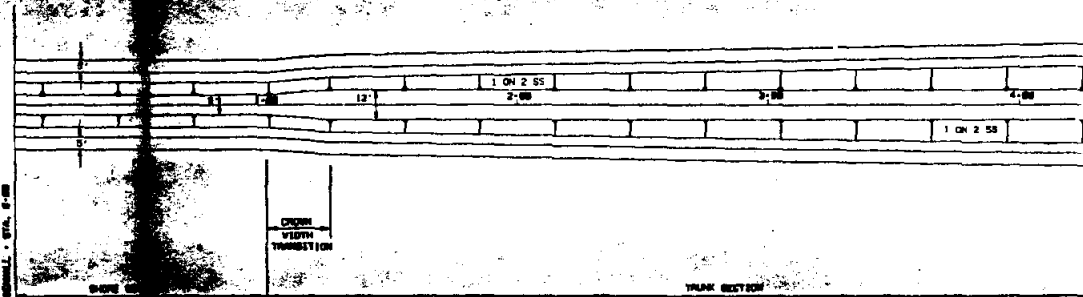

PLAN

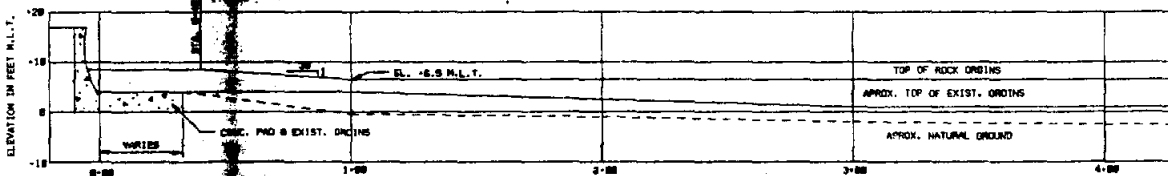

ELEVATION

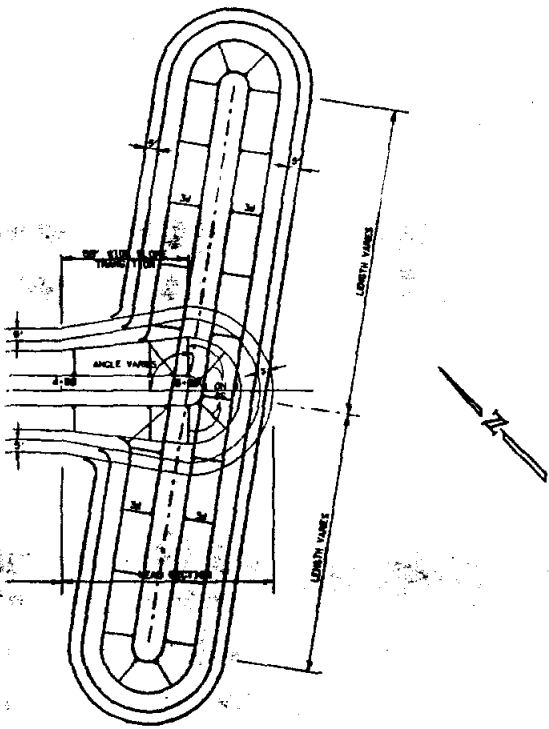

**EXHIBIT 13**

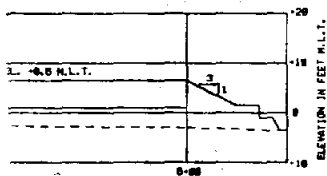

DANNENBAUM ENGINEERING CORPORATION  
HOUSTON, TEXAS  
TEXAS A&M UNIVERSITY GALVESTON

GALVESTON COUNTY'S SHORE LINE FLOOD PROTECTION,  
RESTORATION AND IMPLEMENTATION PLAN  
FOR  
GALVESTON COUNTY AND THE CITY OF GALVESTON  
AND THE TEXAS WATER DEVELOPMENT BOARD

**GROIN MODIFICATION**

RESIDENCE

LINE  
MIN

— EXISTING BULKHEAD  
ION

**EXHIBIT 14**

DANNENBAUM ENGINEERING CORPORATION  
HOUSTON, TEXAS

TEXAS A&M UNIVERSITY GALVESTON

GALVESTON COUNTY'S SHORE LINE FLOOD PROTECTION,  
RESTORATION AND IMPLEMENTATION PLAN  
FOR

GALVESTON COUNTY AND THE CITY OF GALVESTON  
AND THE TEXAS WATER DEVELOPMENT BOARD

**ROADWAY TERMINATION**

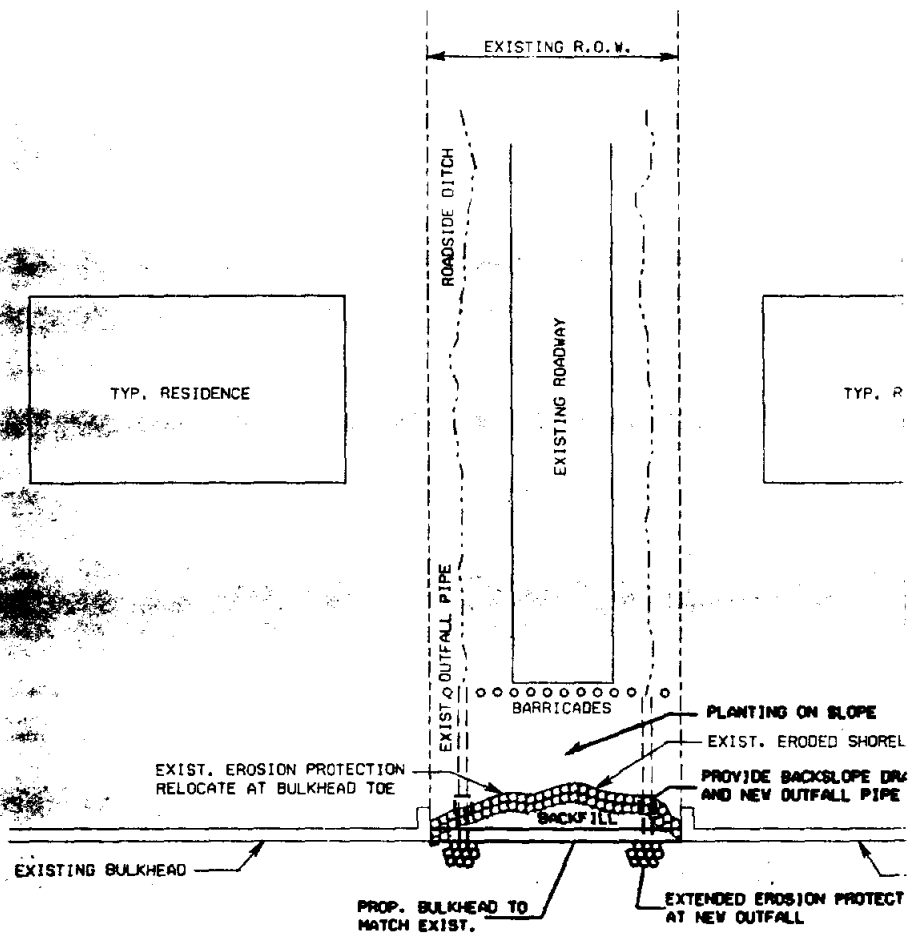

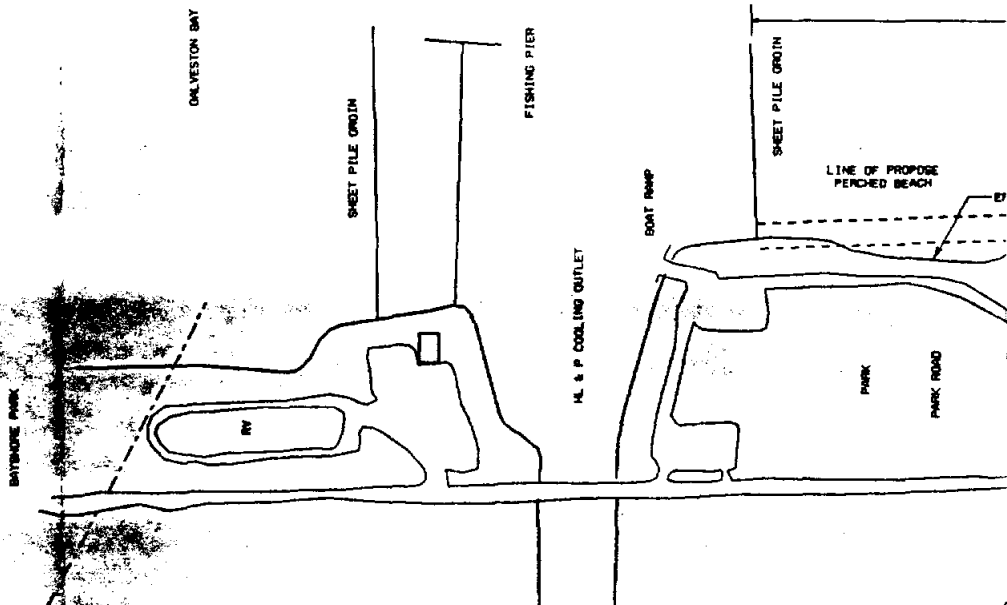

**PLAN**

SCALE: 1" = 300'

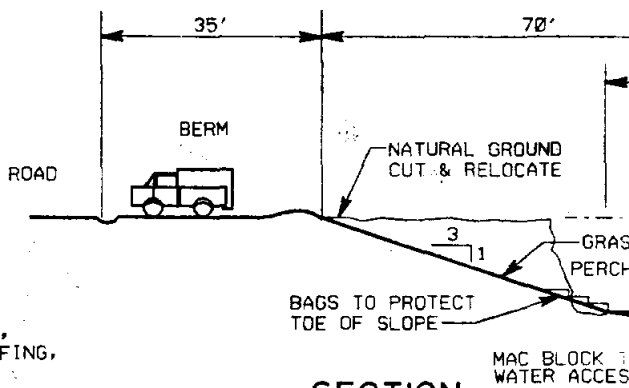

**SECTION**

N.T.S.

ALTERNATIVE 1: REMOVE EXISTING MATERIAL, REGRADE, AND DEVELOP A PERCHED BEACH. SUN BATHING, FISHING, CRABBING, WINDSURFING, BOATING, STROLLING, ETC.

ALTERNATIVE 2: SAME AS ALTERNATIVE 1, EXCEPT ADD STONE RIP-RAP TO THE SLOPES OR (BAG WALLS)



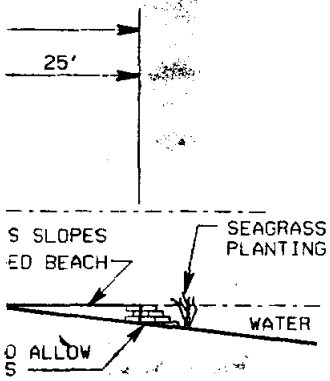
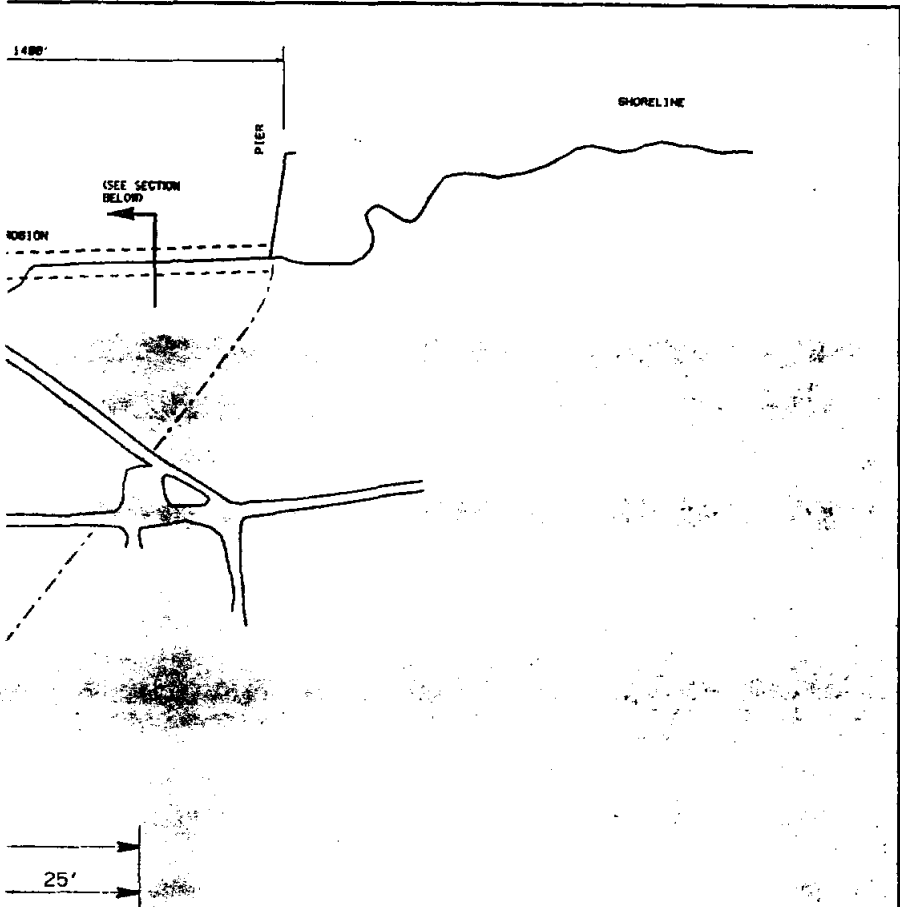

**EXHIBIT 15**

DANNENBAUM ENGINEERING CORPORATION  
 HOUSTON, TEXAS  
 TEXAS A&M UNIVERSITY GALVESTON  
 GALVESTON COUNTY'S SHORE LINE FLOOD PROTECTION,  
 RESTORATION AND IMPLEMENTATION PLAN  
 FOR  
 GALVESTON COUNTY AND THE CITY OF GALVESTON  
 AND THE TEXAS WATER DEVELOPMENT BOARD

**BAY SHORE PARK**